

MBT3946DW1T1G, SMBT3946DW1T1G

Complementary General Purpose Transistor

The MBT3946DW1T1G device is a spin-off of our popular SOT-23/SOT-323 three-leaded device. It is designed for general purpose amplifier applications and is housed in the SOT-363-6 surface mount package. By putting two discrete devices in one package, this device is ideal for low-power surface mount applications where board space is at a premium.

Features

- h_{FE} , 100–300
- Low $V_{CE(sat)}$, ≤ 0.4 V
- Simplifies Circuit Design
- Reduces Board Space
- Reduces Component Count
- S Prefix for Automotive and Other Applications Requiring Unique Site and Control Change Requirements; AEC-Q101 Qualified and PPAP Capable
- These Devices are Pb-Free, Halogen Free/BFR Free and are RoHS Compliant

Table 1. MAXIMUM RATINGS

Rating	Symbol	Value	Unit
Collector – Emitter Voltage (NPN) (PNP)	V_{CEO}	40 –40	Vdc
Collector – Base Voltage (NPN) (PNP)	V_{CBO}	60 –40	Vdc
Emitter – Base Voltage (NPN) (PNP)	V_{EBO}	6.0 –5.0	Vdc
Collector Current – Continuous (NPN) (PNP)	I_C	200 –200	mAdc
Electrostatic Discharge	ESD	HBM Class 2 MM Class B	

Stresses exceeding Maximum Ratings may damage the device. Maximum Ratings are stress ratings only. Functional operation above the Recommended Operating Conditions is not implied. Extended exposure to stresses above the Recommended Operating Conditions may affect device reliability.

Table 2. THERMAL CHARACTERISTICS

Characteristic	Symbol	Max	Unit
Total Package Dissipation (Note 1) $T_A = 25^\circ\text{C}$	P_D	150	mW
Thermal Resistance, Junction-to-Ambient	$R_{\theta JA}$	833	$^\circ\text{C/W}$
Junction and Storage Temperature Range	T_J, T_{stg}	–55 to +150	$^\circ\text{C}$

1. Device mounted on FR4 glass epoxy printed circuit board using the minimum recommended footprint.



ON Semiconductor®

<http://onsemi.com>



**SOT-363/SC-88
CASE 419B
STYLE 1**

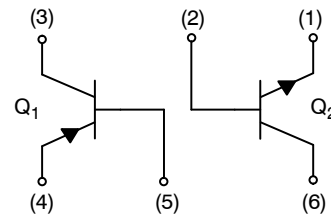

MBT3946DW1T1*
*Q1 PNP
Q2 NPN

MARKING DIAGRAM

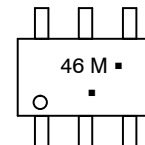

46 = Specific Device Code
M = Date Code
▪ = Pb-Free Package

(Note: Microdot may be in either location)

ORDERING INFORMATION

Device	Package	Shipping†
MBT3946DW1T1G	SC-88 (Pb-Free)	3,000 / Tape & Reel
SMBT3946DW1T1G	SC-88 (Pb-Free)	3,000 / Tape & Reel
MBT3946DW1T2G	SC-88 (Pb-Free)	3,000 / Tape & Reel

†For information on tape and reel specifications, including part orientation and tape sizes, please refer to our Tape and Reel Packaging Specifications Brochure, BRD8011/D.

MBT3946DW1T1G, SMT3946DW1T1G

Table 3. ELECTRICAL CHARACTERISTICS ($T_A = 25^\circ\text{C}$ unless otherwise noted)

Characteristic	Symbol	Min	Max	Unit	
OFF CHARACTERISTICS					
Collector–Emitter Breakdown Voltage (Note 2) ($I_C = 1.0\text{ mAdc}$, $I_B = 0$) ($I_C = -1.0\text{ mAdc}$, $I_B = 0$)	(NPN) (PNP)	$V_{(BR)CEO}$	40 –40	– –	Vdc
Collector–Base Breakdown Voltage ($I_C = 10\text{ }\mu\text{Adc}$, $I_E = 0$) ($I_C = -10\text{ }\mu\text{Adc}$, $I_E = 0$)	(NPN) (PNP)	$V_{(BR)CBO}$	60 –40	– –	Vdc
Emitter–Base Breakdown Voltage ($I_E = 10\text{ }\mu\text{Adc}$, $I_C = 0$) ($I_E = -10\text{ }\mu\text{Adc}$, $I_C = 0$)	(NPN) (PNP)	$V_{(BR)EBO}$	6.0 –5.0	– –	Vdc
Base Cutoff Current ($V_{CE} = 30\text{ Vdc}$, $V_{EB} = 3.0\text{ Vdc}$) ($V_{CE} = -30\text{ Vdc}$, $V_{EB} = -3.0\text{ Vdc}$)	(NPN) (PNP)	I_{BL}	– –	50 –50	nAdc
Collector Cutoff Current ($V_{CE} = 30\text{ Vdc}$, $V_{EB} = 3.0\text{ Vdc}$) ($V_{CE} = -30\text{ Vdc}$, $V_{EB} = -3.0\text{ Vdc}$)	(NPN) (PNP)	I_{CEX}	– –	50 –50	nAdc
ON CHARACTERISTICS (Note 2)					
DC Current Gain ($I_C = 0.1\text{ mAdc}$, $V_{CE} = 1.0\text{ Vdc}$) ($I_C = 1.0\text{ mAdc}$, $V_{CE} = 1.0\text{ Vdc}$) ($I_C = 10\text{ mAdc}$, $V_{CE} = 1.0\text{ Vdc}$) ($I_C = 50\text{ mAdc}$, $V_{CE} = 1.0\text{ Vdc}$) ($I_C = 100\text{ mAdc}$, $V_{CE} = 1.0\text{ Vdc}$) ($I_C = -0.1\text{ mAdc}$, $V_{CE} = -1.0\text{ Vdc}$) ($I_C = -1.0\text{ mAdc}$, $V_{CE} = -1.0\text{ Vdc}$) ($I_C = -10\text{ mAdc}$, $V_{CE} = -1.0\text{ Vdc}$) ($I_C = -50\text{ mAdc}$, $V_{CE} = -1.0\text{ Vdc}$) ($I_C = -100\text{ mAdc}$, $V_{CE} = -1.0\text{ Vdc}$)	(NPN) (PNP)	h_{FE}	40 70 100 60 30 60 80 100 60 30	– – 300 – – – – 300 – –	–
Collector–Emitter Saturation Voltage ($I_C = 10\text{ mAdc}$, $I_B = 1.0\text{ mAdc}$) ($I_C = 50\text{ mAdc}$, $I_B = 5.0\text{ mAdc}$) ($I_C = -10\text{ mAdc}$, $I_B = -1.0\text{ mAdc}$) ($I_C = -50\text{ mAdc}$, $I_B = -5.0\text{ mAdc}$)	(NPN) (PNP)	$V_{CE(sat)}$	– – – –	0.2 0.3 –0.25 –0.4	Vdc
Base–Emitter Saturation Voltage ($I_C = 10\text{ mAdc}$, $I_B = 1.0\text{ mAdc}$) ($I_C = 50\text{ mAdc}$, $I_B = 5.0\text{ mAdc}$) ($I_C = -10\text{ mAdc}$, $I_B = -1.0\text{ mAdc}$) ($I_C = -50\text{ mAdc}$, $I_B = -5.0\text{ mAdc}$)	(NPN) (PNP)	$V_{BE(sat)}$	0.65 – –0.65 –	0.85 0.95 –0.85 –0.95	Vdc
SMALL-SIGNAL CHARACTERISTICS					
Current–Gain – Bandwidth Product ($I_C = 10\text{ mAdc}$, $V_{CE} = 20\text{ Vdc}$, $f = 100\text{ MHz}$) ($I_C = -10\text{ mAdc}$, $V_{CE} = -20\text{ Vdc}$, $f = 100\text{ MHz}$)	(NPN) (PNP)	f_T	300 250	– –	MHz
Output Capacitance ($V_{CB} = 5.0\text{ Vdc}$, $I_E = 0$, $f = 1.0\text{ MHz}$) ($V_{CB} = -5.0\text{ Vdc}$, $I_E = 0$, $f = 1.0\text{ MHz}$)	(NPN) (PNP)	C_{obo}	– –	4.0 4.5	pF
Input Capacitance ($V_{EB} = 0.5\text{ Vdc}$, $I_C = 0$, $f = 1.0\text{ MHz}$) ($V_{EB} = -0.5\text{ Vdc}$, $I_C = 0$, $f = 1.0\text{ MHz}$)	(NPN) (PNP)	C_{ibo}	– –	8.0 10.0	pF
Input Impedance ($V_{CE} = 10\text{ Vdc}$, $I_C = 1.0\text{ mAdc}$, $f = 1.0\text{ kHz}$) ($V_{CE} = -10\text{ Vdc}$, $I_C = -1.0\text{ mAdc}$, $f = 1.0\text{ kHz}$)	(NPN) (PNP)	h_{ie}	1.0 2.0	10 12	k Ω
Voltage Feedback Ratio ($V_{CE} = 10\text{ Vdc}$, $I_C = 1.0\text{ mAdc}$, $f = 1.0\text{ kHz}$) ($V_{CE} = -10\text{ Vdc}$, $I_C = -1.0\text{ mAdc}$, $f = 1.0\text{ kHz}$)	(NPN) (PNP)	h_{re}	0.5 0.1	8.0 10	$\times 10^{-4}$
Small–Signal Current Gain ($V_{CE} = 10\text{ Vdc}$, $I_C = 1.0\text{ mAdc}$, $f = 1.0\text{ kHz}$) ($V_{CE} = -10\text{ Vdc}$, $I_C = -1.0\text{ mAdc}$, $f = 1.0\text{ kHz}$)	(NPN) (PNP)	h_{fe}	100 100	400 400	–

MBT3946DW1T1G, SMBT3946DW1T1G

Table 4. ELECTRICAL CHARACTERISTICS ($T_A = 25^\circ\text{C}$ unless otherwise noted) (continued)

Characteristic	Symbol	Min	Max	Unit
Output Admittance ($V_{CE} = 10\text{ Vdc}$, $I_C = 1.0\text{ mAdc}$, $f = 1.0\text{ kHz}$) ($V_{CE} = -10\text{ Vdc}$, $I_C = -1.0\text{ mAdc}$, $f = 1.0\text{ kHz}$)	h_{oe} (NPN) (PNP)	1.0 3.0	40 60	μmhos
Noise Figure ($V_{CE} = 5.0\text{ Vdc}$, $I_C = 100\ \mu\text{A}$, $R_S = 1.0\text{ k}\Omega$, $f = 1.0\text{ kHz}$) ($V_{CE} = -5.0\text{ Vdc}$, $I_C = -100\ \mu\text{A}$, $R_S = 1.0\text{ k}\Omega$, $f = 1.0\text{ kHz}$)	NF (NPN) (PNP)	- -	5.0 4.0	dB

SWITCHING CHARACTERISTICS

Delay Time ($V_{CC} = 3.0\text{ Vdc}$, $V_{BE} = -0.5\text{ Vdc}$) ($V_{CC} = -3.0\text{ Vdc}$, $V_{BE} = 0.5\text{ Vdc}$)	(NPN) (PNP)	t_d	- -	35 35	ns
Rise Time ($I_C = 10\text{ mAdc}$, $I_{B1} = 1.0\text{ mAdc}$) ($I_C = -10\text{ mAdc}$, $I_{B1} = -1.0\text{ mAdc}$)	(NPN) (PNP)	t_r	- -	35 35	
Storage Time ($V_{CC} = 3.0\text{ Vdc}$, $I_C = 10\text{ mAdc}$) ($V_{CC} = -3.0\text{ Vdc}$, $I_C = -10\text{ mAdc}$)	(NPN) (PNP)	t_s	- -	200 225	ns
Fall Time ($I_{B1} = I_{B2} = 1.0\text{ mAdc}$) ($I_{B1} = I_{B2} = -1.0\text{ mAdc}$)	(NPN) (PNP)	t_f	- -	50 75	

2. Pulse Test: Pulse Width $\leq 300\ \mu\text{s}$; Duty Cycle $\leq 2.0\%$.

(NPN)

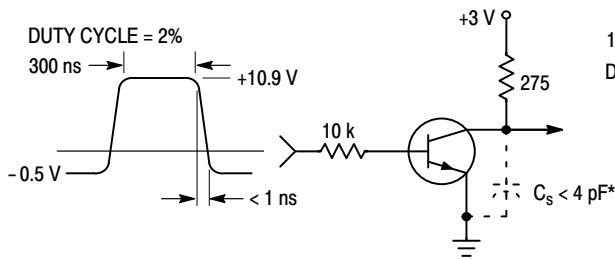

Figure 1. Delay and Rise Time Equivalent Test Circuit

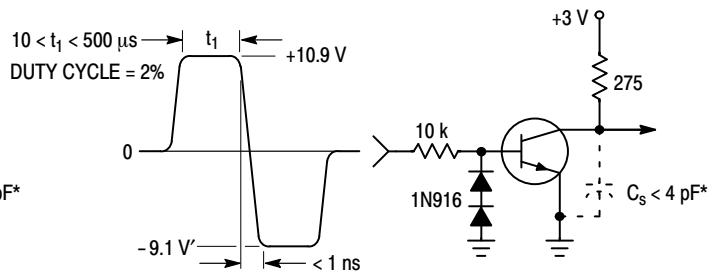

Figure 2. Storage and Fall Time Equivalent Test Circuit

* Total shunt capacitance of test jig and connectors

TYPICAL TRANSIENT CHARACTERISTICS

— $T_J = 25^\circ\text{C}$
- - - $T_J = 125^\circ\text{C}$

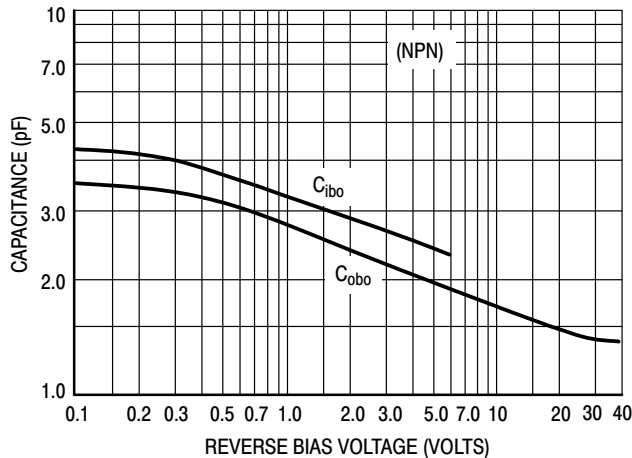

Figure 3. Capacitance

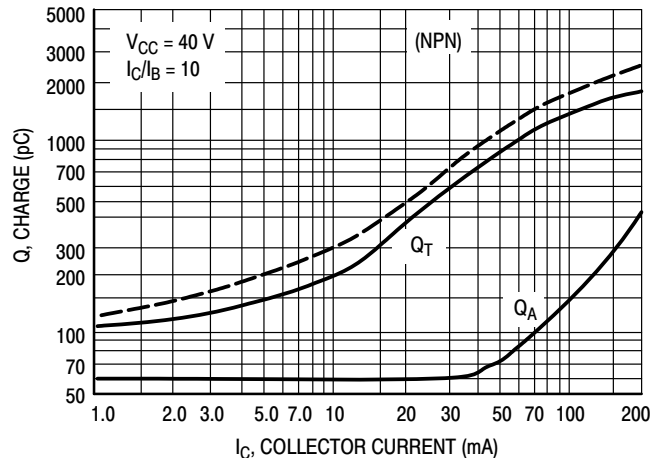

Figure 4. Charge Data

MBT3946DW1T1G, SMBT3946DW1T1G

(NPN)

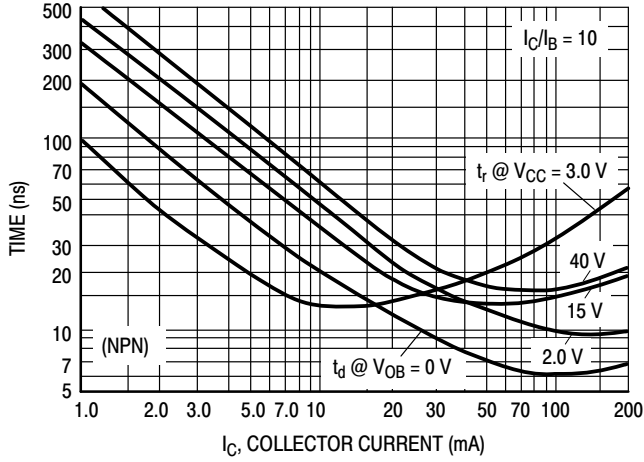

Figure 5. Turn-On Time

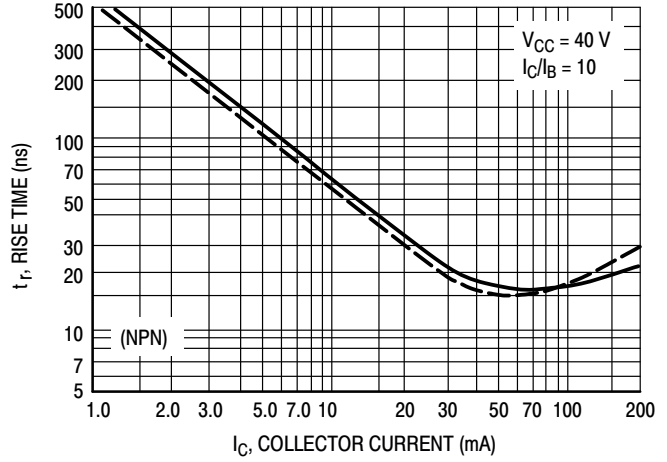

Figure 6. Rise Time

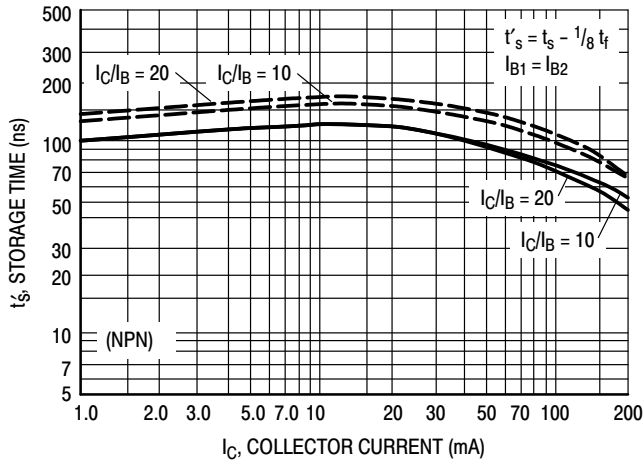

Figure 7. Storage Time

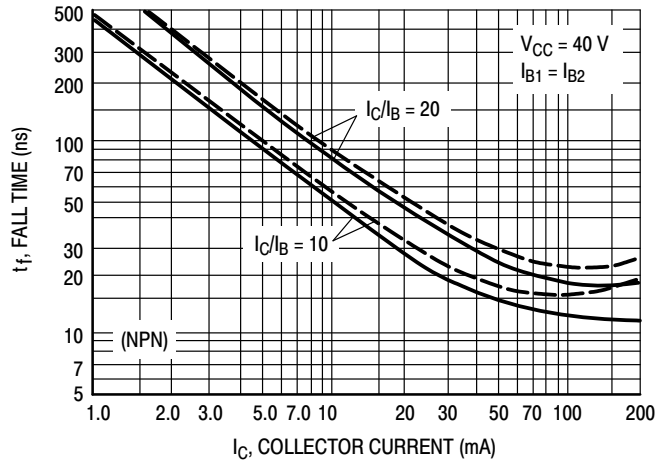

Figure 8. Fall Time

TYPICAL AUDIO SMALL-SIGNAL CHARACTERISTICS NOISE FIGURE VARIATIONS

($V_{CE} = 5.0$ Vdc, $T_A = 25^\circ\text{C}$, Bandwidth = 1.0 Hz)

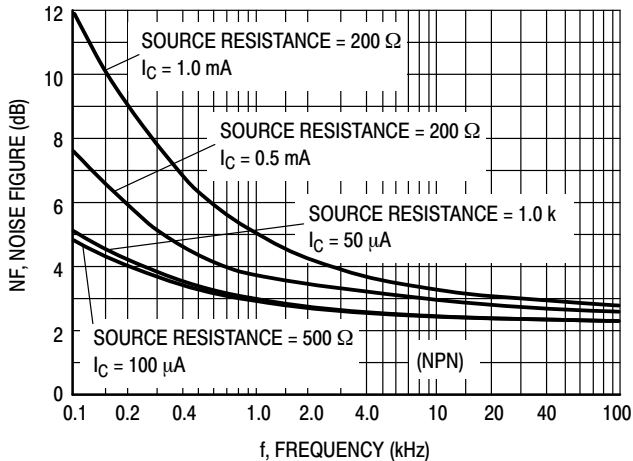

Figure 9. Noise Figure

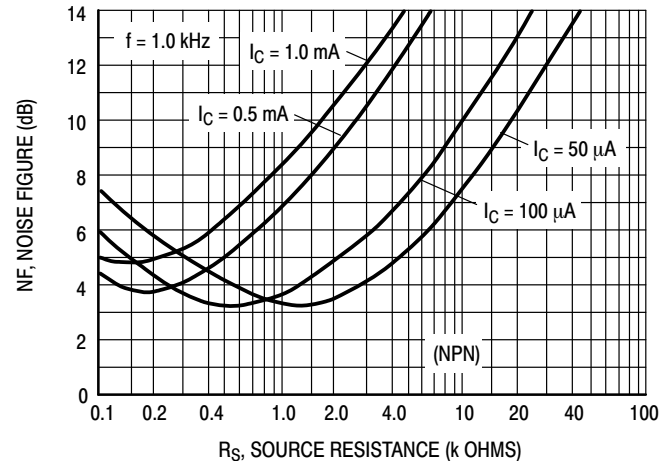

Figure 10. Noise Figure

MBT3946DW1T1G, SMBT3946DW1T1G

(NPN) h PARAMETERS

($V_{CE} = 10 \text{ Vdc}$, $f = 1.0 \text{ kHz}$, $T_A = 25^\circ\text{C}$)

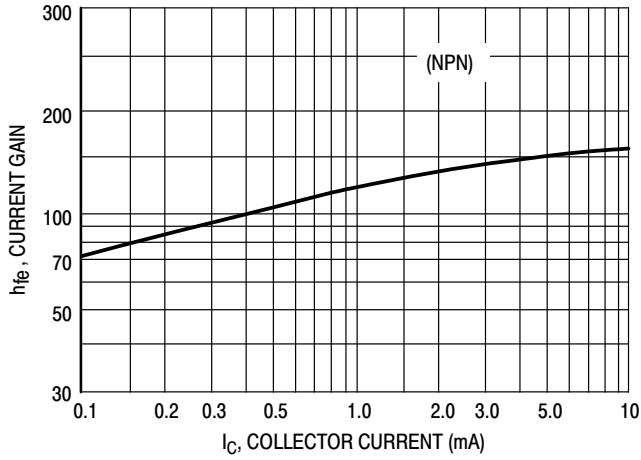

Figure 11. Current Gain

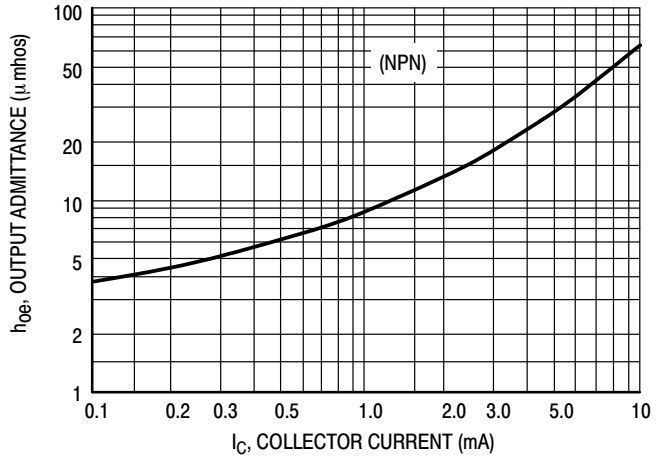

Figure 12. Output Admittance

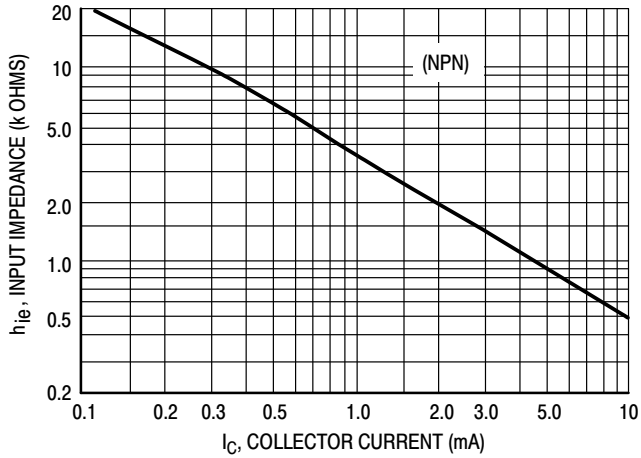

Figure 13. Input Impedance

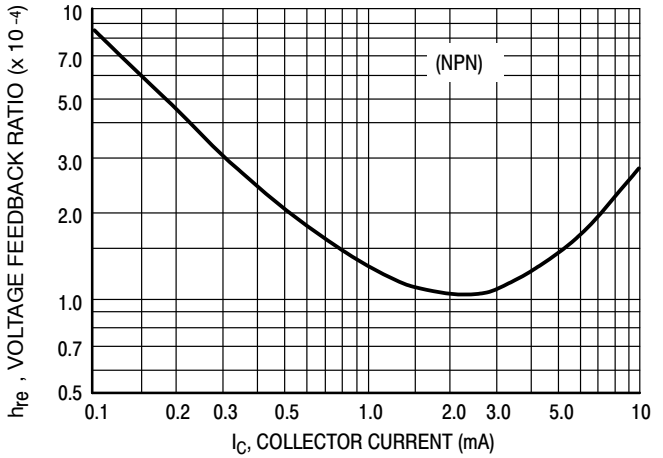

Figure 14. Voltage Feedback Ratio

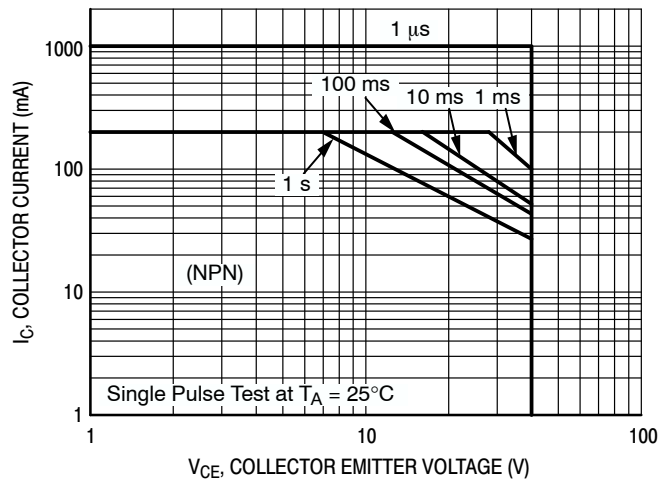

Figure 15. Safe Operating Area

MBT3946DW1T1G, SMBT3946DW1T1G

(NPN) TYPICAL STATIC CHARACTERISTICS



Figure 16. DC Current Gain

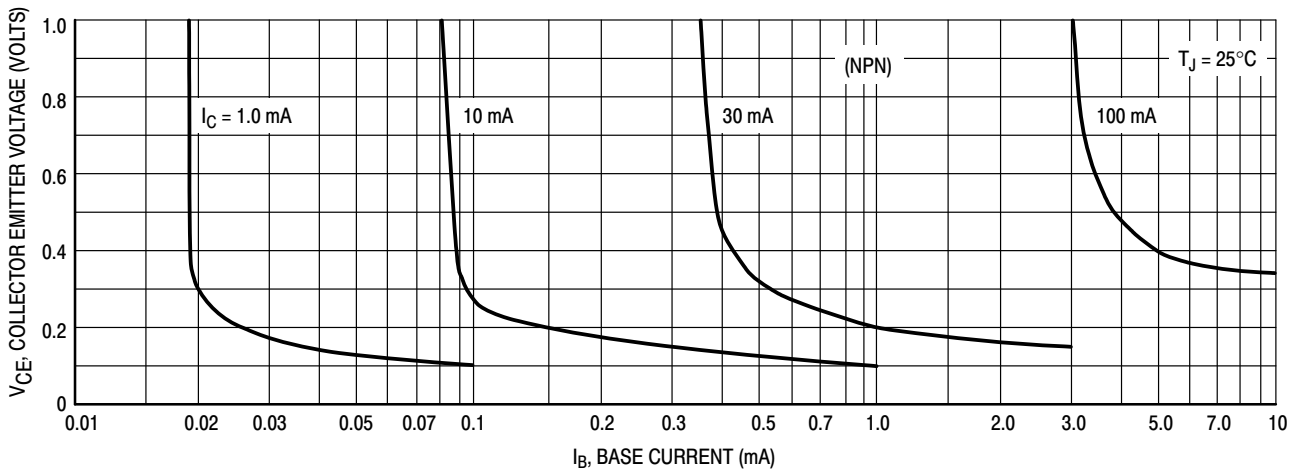

Figure 17. Collector Saturation Region

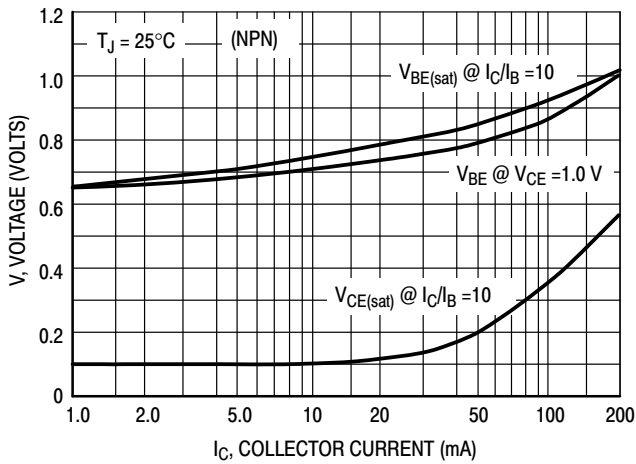

Figure 18. "ON" Voltages

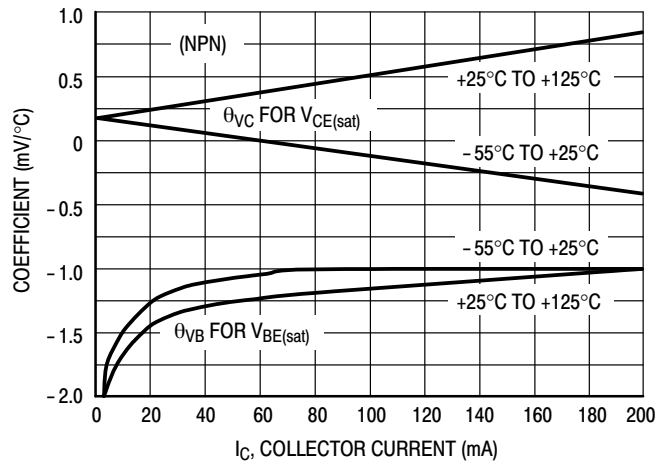

Figure 19. Temperature Coefficients

MBT3946DW1T1G, SMBT3946DW1T1G

(PNP)

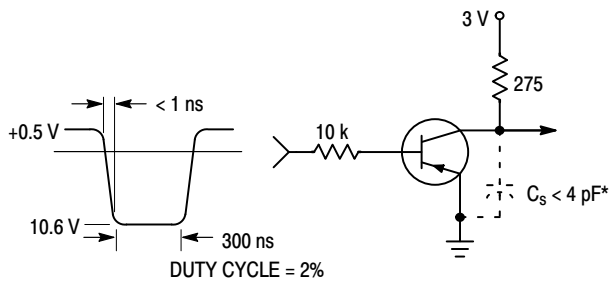

Figure 20. Delay and Rise Time Equivalent Test Circuit

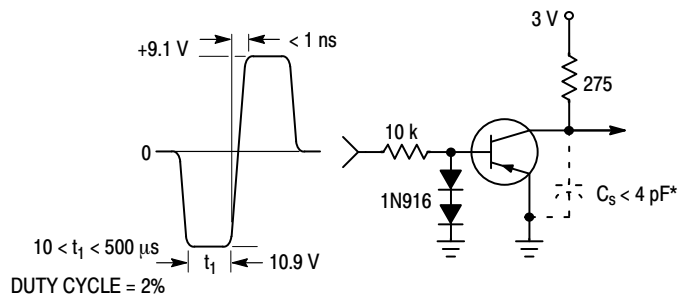

Figure 21. Storage and Fall Time Equivalent Test Circuit

* Total shunt capacitance of test jig and connectors

TYPICAL TRANSIENT CHARACTERISTICS

— $T_J = 25^\circ\text{C}$
 - - - $T_J = 125^\circ\text{C}$

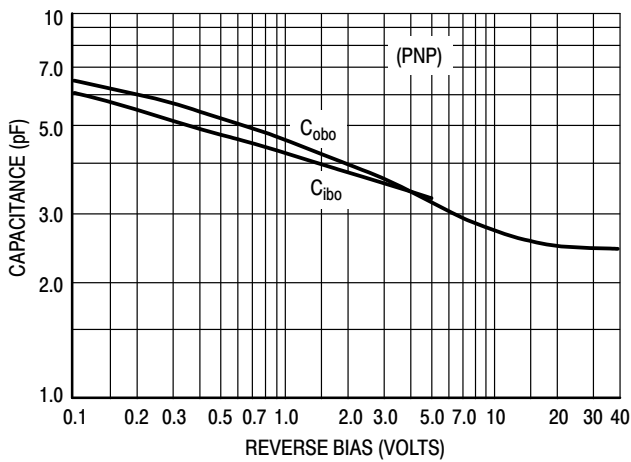

Figure 22. Capacitance

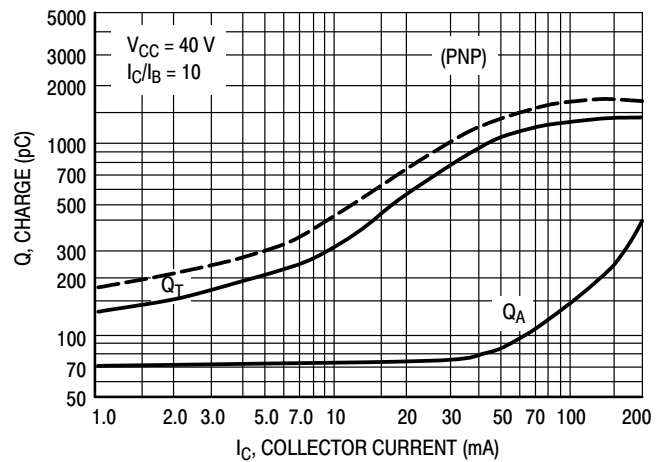

Figure 23. Charge Data

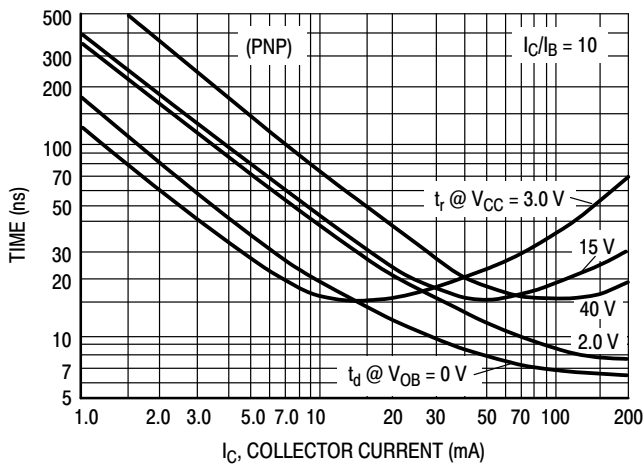

Figure 24. Turn-On Time

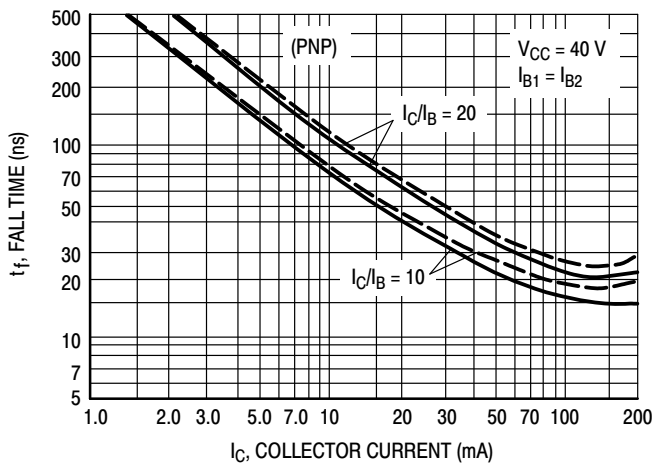

Figure 25. Fall Time

MBT3946DW1T1G, SMBT3946DW1T1G

(PNP)

TYPICAL AUDIO SMALL-SIGNAL CHARACTERISTICS NOISE FIGURE VARIATIONS

($V_{CE} = -5.0$ Vdc, $T_A = 25^\circ\text{C}$, Bandwidth = 1.0 Hz)



Figure 26.

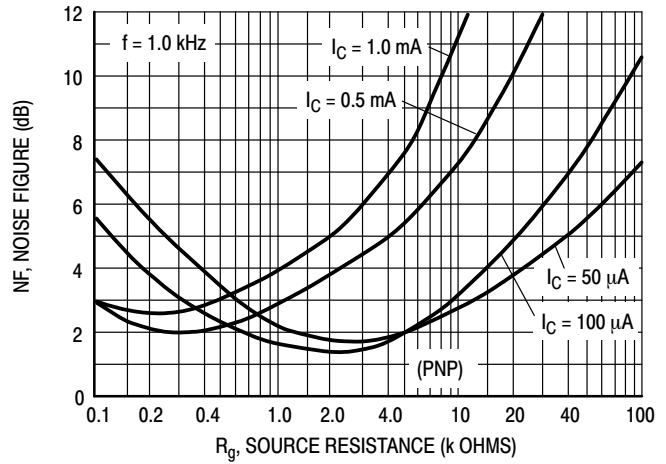

Figure 27.

h PARAMETERS

($V_{CE} = -10$ Vdc, $f = 1.0$ kHz, $T_A = 25^\circ\text{C}$)

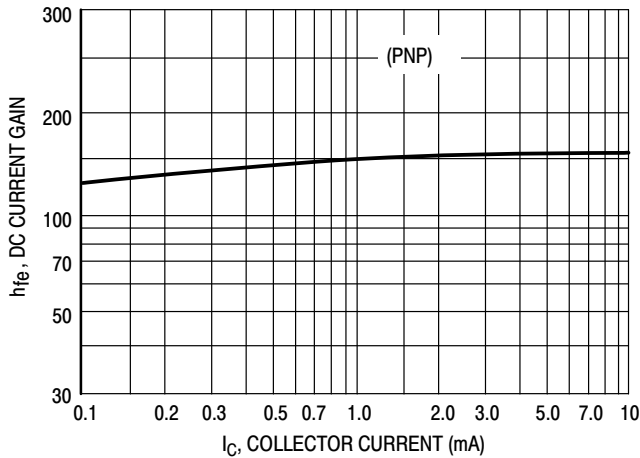

Figure 28. Current Gain

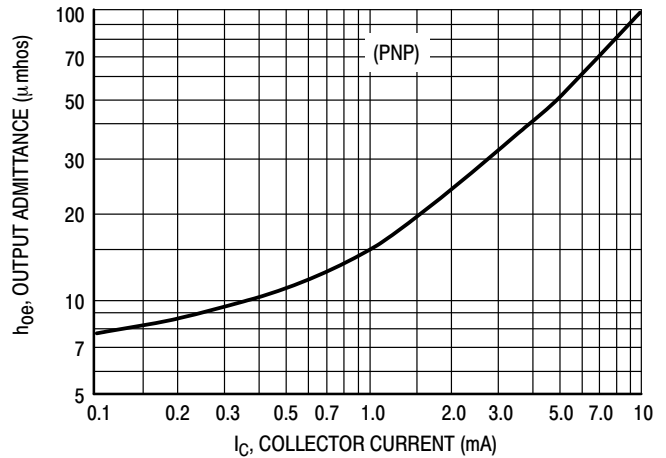

Figure 29. Output Admittance

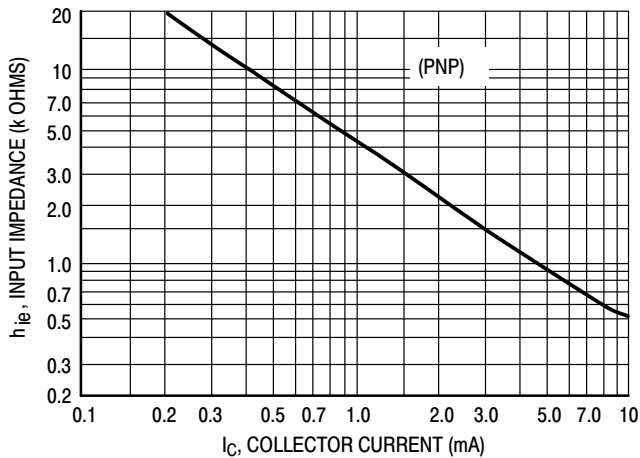

Figure 30. Input Impedance

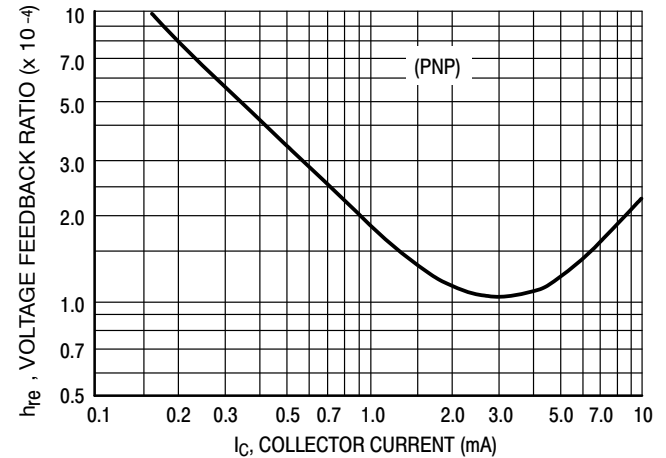

Figure 31. Voltage Feedback Ratio

MBT3946DW1T1G, SMT3946DW1T1G

(PNP)

TYPICAL STATIC CHARACTERISTICS

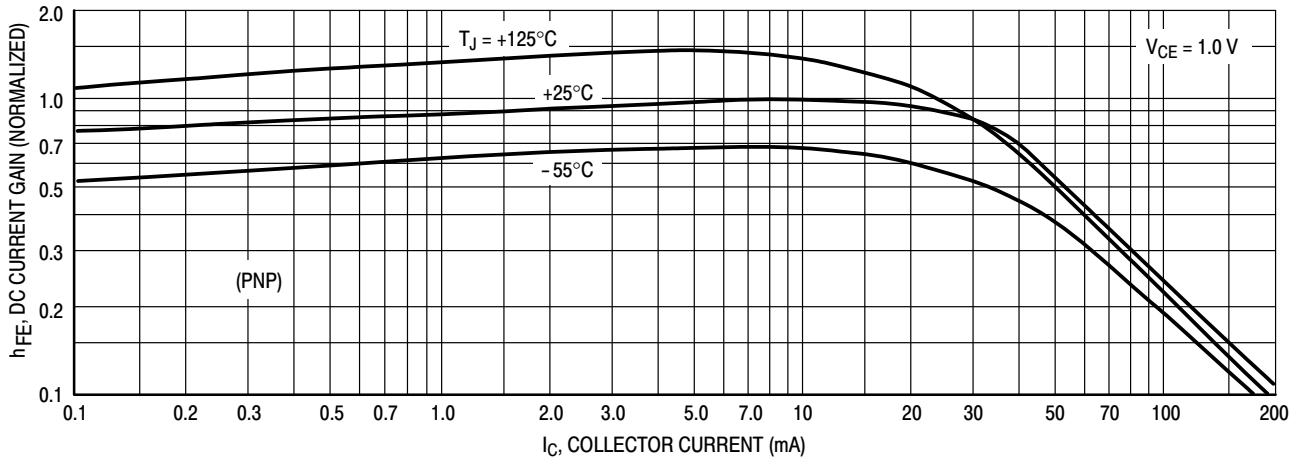

Figure 32. DC Current Gain

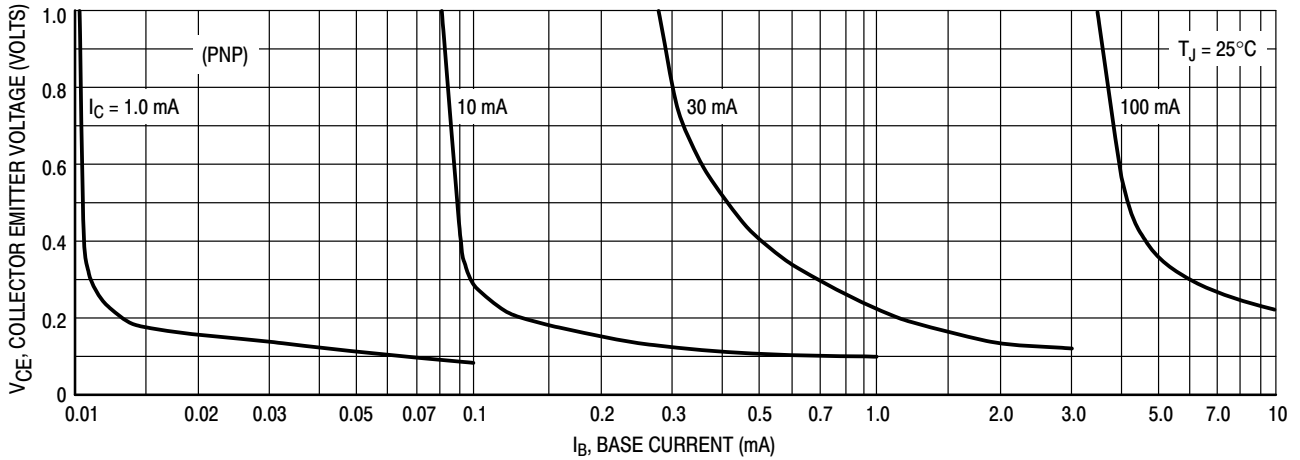

Figure 33. Collector Saturation Region

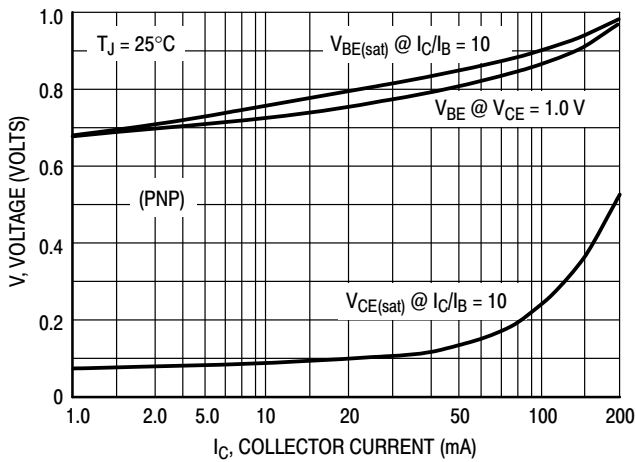

Figure 34. "ON" Voltages

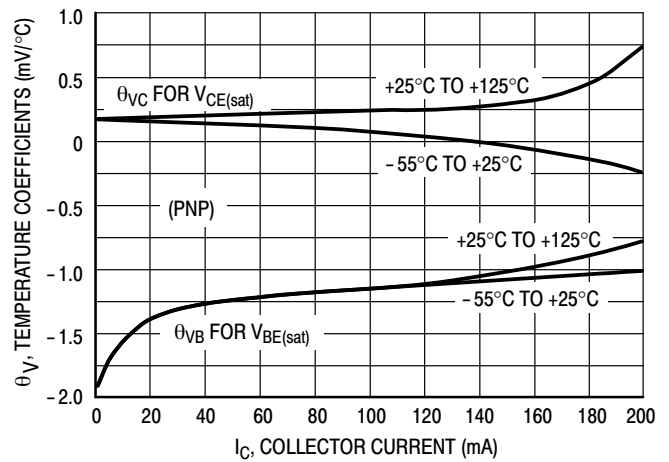

Figure 35. Temperature Coefficients

MBT3946DW1T1G, SMBT3946DW1T1G

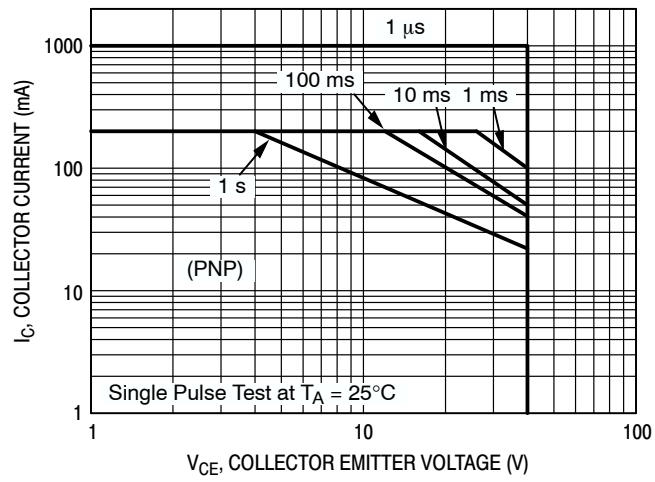
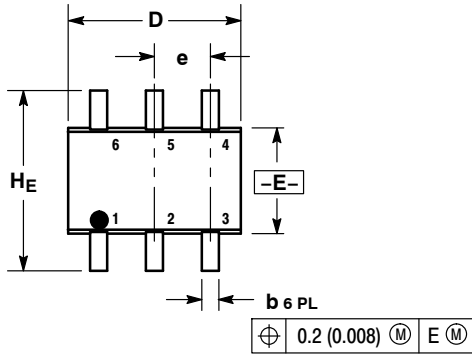

Figure 36. Safe Operating Area

MBT3946DW1T1G, SMBT3946DW1T1G

PACKAGE DIMENSIONS

SC-88/SC70-6/SOT-363
CASE 419B-02
ISSUE W



NOTES:

1. DIMENSIONING AND TOLERANCING PER ANSI Y14.5M, 1982.
2. CONTROLLING DIMENSION: INCH.
3. 419B-01 OBSOLETE, NEW STANDARD 419B-02.

DIM	MILLIMETERS			INCHES		
	MIN	NOM	MAX	MIN	NOM	MAX
A	0.80	0.95	1.10	0.031	0.037	0.043
A1	0.00	0.05	0.10	0.000	0.002	0.004
A3	0.20 REF			0.008 REF		
b	0.10	0.21	0.30	0.004	0.008	0.012
C	0.10	0.14	0.25	0.004	0.005	0.010
D	1.80	2.00	2.20	0.070	0.078	0.086
E	1.15	1.25	1.35	0.045	0.049	0.053
e	0.65 BSC			0.026 BSC		
L	0.10	0.20	0.30	0.004	0.008	0.012
H _E	2.00	2.10	2.20	0.078	0.082	0.086

STYLE 1:

1. EMITTER 2
2. BASE 2
3. COLLECTOR 1
4. EMITTER 1
5. BASE 1
6. COLLECTOR 2

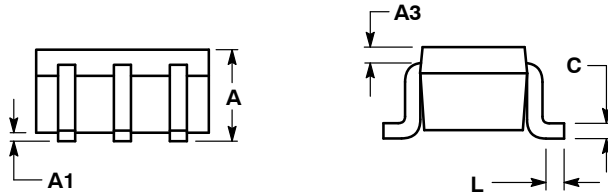

SOLDERING FOOTPRINT*

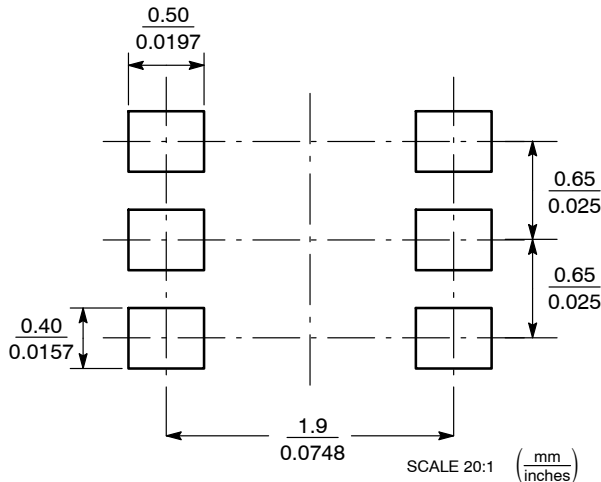

*For additional information on our Pb-Free strategy and soldering details, please download the ON Semiconductor Soldering and Mounting Techniques Reference Manual, SOLDERRM/D.

ON Semiconductor and are registered trademarks of Semiconductor Components Industries, LLC (SCILLC). SCILLC owns the rights to a number of patents, trademarks, copyrights, trade secrets, and other intellectual property. A listing of SCILLC's product/patent coverage may be accessed at www.onsemi.com/site/pdf/Patent-Marking.pdf. SCILLC reserves the right to make changes without further notice to any products herein. SCILLC makes no warranty, representation or guarantee regarding the suitability of its products for any particular purpose, nor does SCILLC assume any liability arising out of the application or use of any product or circuit, and specifically disclaims any and all liability, including without limitation special, consequential or incidental damages. "Typical" parameters which may be provided in SCILLC data sheets and/or specifications can and do vary in different applications and actual performance may vary over time. All operating parameters, including "Typicals" must be validated for each customer application by customer's technical experts. SCILLC does not convey any license under its patent rights nor the rights of others. SCILLC products are not designed, intended, or authorized for use as components in systems intended for surgical implant into the body, or other applications intended to support or sustain life, or for any other application in which the failure of the SCILLC product could create a situation where personal injury or death may occur. Should Buyer purchase or use SCILLC products for any such unintended or unauthorized application, Buyer shall indemnify and hold SCILLC and its officers, employees, subsidiaries, affiliates, and distributors harmless against all claims, costs, damages, and expenses, and reasonable attorney fees arising out of, directly or indirectly, any claim of personal injury or death associated with such unintended or unauthorized use, even if such claim alleges that SCILLC was negligent regarding the design or manufacture of the part. SCILLC is an Equal Opportunity/Affirmative Action Employer. This literature is subject to all applicable copyright laws and is not for resale in any manner.

PUBLICATION ORDERING INFORMATION

LITERATURE FULFILLMENT:
Literature Distribution Center for ON Semiconductor
P.O. Box 5163, Denver, Colorado 80217 USA
Phone: 303-675-2175 or 800-344-3860 Toll Free USA/Canada
Fax: 303-675-2176 or 800-344-3867 Toll Free USA/Canada
Email: orderlit@onsemi.com

N. American Technical Support: 800-282-9855 Toll Free
USA/Canada
Europe, Middle East and Africa Technical Support:
Phone: 421 33 790 2910
Japan Customer Focus Center
Phone: 81-3-5817-1050

ON Semiconductor Website: www.onsemi.com
Order Literature: <http://www.onsemi.com/orderlit>
For additional information, please contact your local Sales Representative

Mouser Electronics

Authorized Distributor

Click to View Pricing, Inventory, Delivery & Lifecycle Information:

[ON Semiconductor:](#)

[SMBT3946DW1T1G](#)