

THIS DRAWING IS UNPUBLISHED.

RELEASED FOR PUBLICATION

© COPYRIGHT

ALL RIGHTS RESERVED.

LOC	DIST
-	-

REVISIONS

P	LTR	DESCRIPTION	DATE	DWN	APVD
A		INITIAL RELEASE	08AUG2014	PS	JK

REFERENCE MATING INTERFACE PATTERN:
1,27 STAGGERED PITCH x 1,5 ROW-DISTANCE.

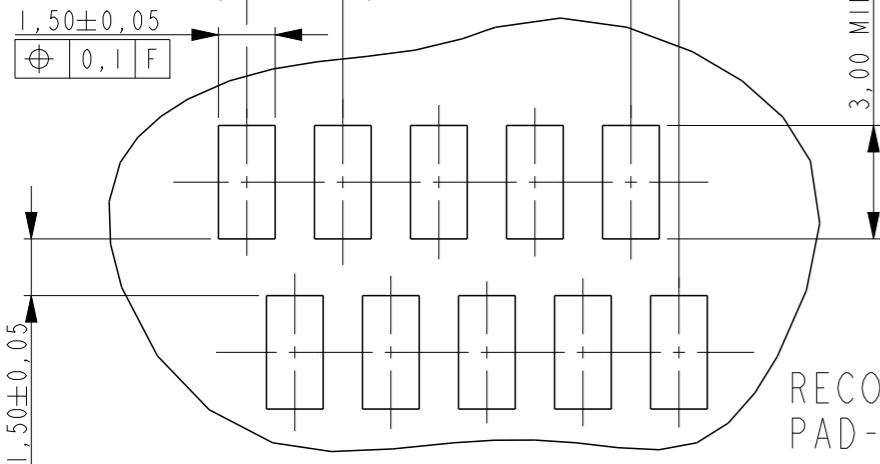
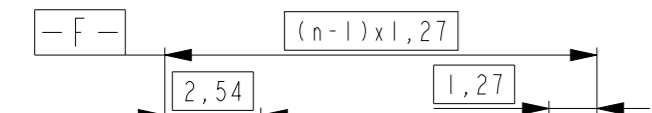
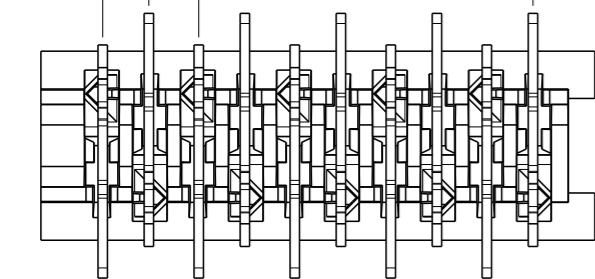
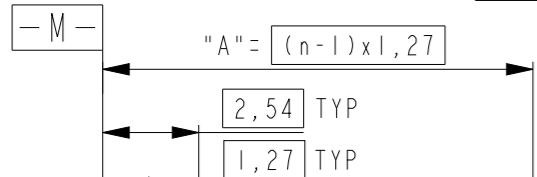
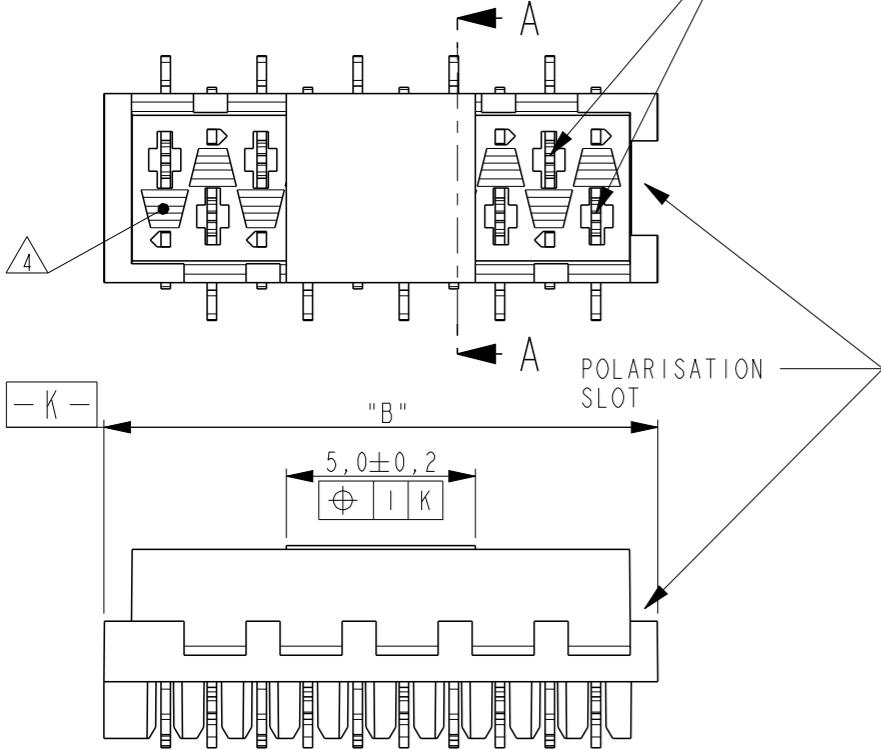

RECOMMENDED PC-BOARD
PAD-LAYOUT TOP VIEW

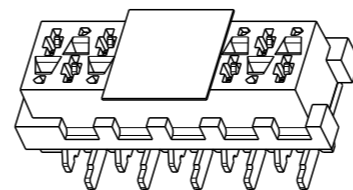
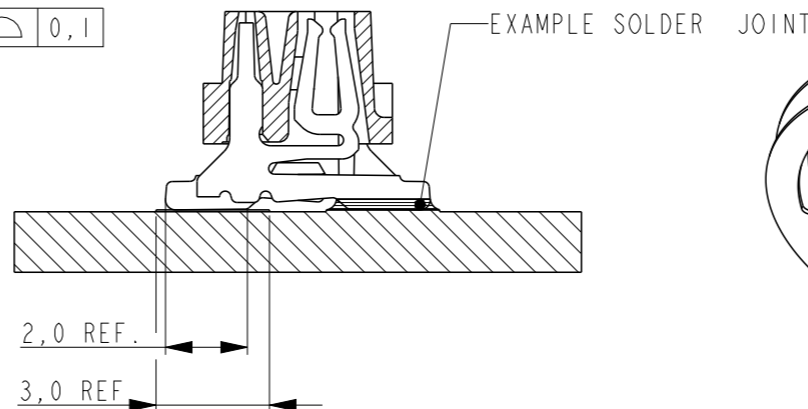
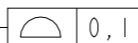
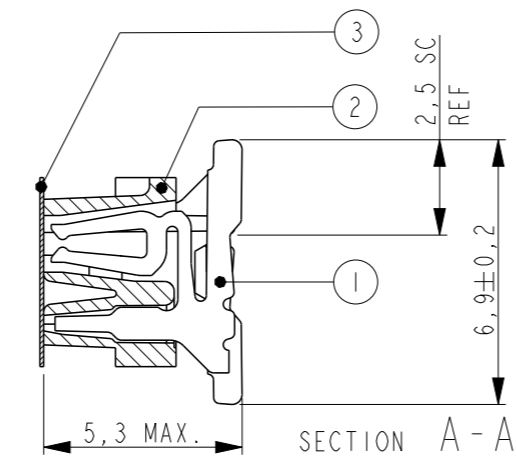

SCALE 3:1

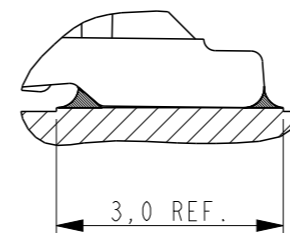

SOLDER DETAIL
SCALE 10:1

1 PARTNUMBER VAC. TAPE.	3 PARTNUMBER	NO. OF POS. "n"	"A"	"B" MAX.
7-2178711-4	2178711-4	4	3,81	7,1
7-2178711-6	2178711-6	6	6,35	9,7
7-2178711-8	2178711-8	8	8,89	12,2
8-2178711-0	1-2178711-0	10	11,43	14,7
8-2178711-2	1-2178711-2	12	13,97	17,3
8-2178711-4	1-2178711-4	14	16,51	19,8
8-2178711-6	1-2178711-6	16	19,05	22,4
8-2178711-8	1-2178711-8	18	21,59	24,9
9-2178711-0	2-2178711-0	20	24,13	27,5

NOTES:

- 1 TAPE FOR VACUUM P&P ONLY FOR DASHNUMBERS 7- /8- /9-
- 2 FOR PACKAGING SEE SHEET 2 OF 2
- 3 WITHOUT VACUUM TAPE.
- 4 CORING-OUTS FOR MANUFACTURING PURPOSE ONLY.
SHAPE MAY VARY, BUT IS NOT FUNCTIONAL FOR THE APPLICATION.
- 5 SHOWN IS A 10 POSITION CONNECTOR.

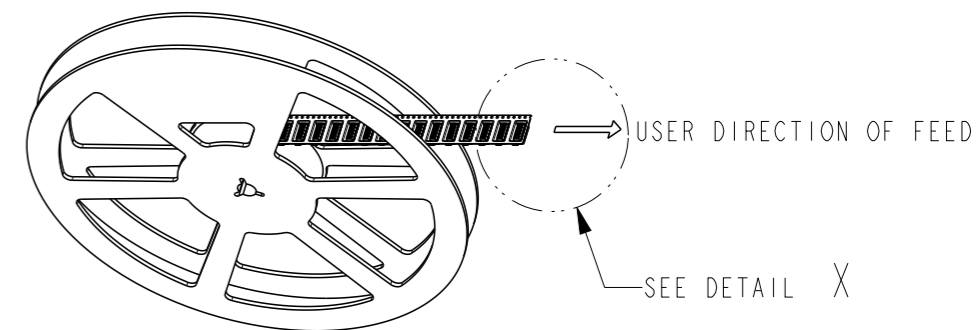

ACCORDING EIA-481/DIN IEC 286

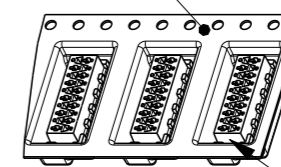

DETAIL X
SCALE 1:1

POLARIZATION-SLOT
ON THIS SIDE.

ITEM NO.	COMPONENT DESCRIPTION	MATERIAL	FINISH / COLOR
3	PICK & PLACE TAPE	KAPTON	AMBER TRANSPARENT
2	FEMALE HOUSING	POLYAMIDE 4/6,GF	BLACK
1	FEMALE CONTACT	TIN BRASS	3.0 - 5.0µm TIN OVER 0.5µm NICKEL

THIS DRAWING IS A CONTROLLED DOCUMENT.		DWN 30JUL2014 PRASHANTH
DIMENSIONS: mm		CHK 05AUG2014 PRASHANTH
TOLERANCES UNLESS OTHERWISE SPECIFIED:		APVD 05AUG2014 JAYANTH KUMAR
0 PLC	±-	PRODUCT SPEC
1 PLC	±-	108-32087
2 PLC	±-	APPLICATION SPEC
3 PLC	±-	114-13318
4 PLC	±-	WEIGHT -
ANGLES	±-	CUSTOMER DRAWING
FINISH	SEE TABLE	SCALE 5:1

NAME	Micro-MaTch VALUE LINE FEMALE-ON-BOARD, TOP ENTRY, SMD, CONNECTOR		
SIZE	CAGE CODE	DRAWING NO	RESTRICTED TO
A3	00779	C-2178711	-
SHEET 1 OF 2		REV A	



THIS DRAWING IS UNPUBLISHED.

RELEASED FOR PUBLICATION

© COPYRIGHT -

ALL RIGHTS RESERVED.

LOC - DIST -

REVISIONS

P LTR

DESCRIPTION

DATE

DWN

APVD

SEE SHEET 1

TAPE WIDTH 24 mm

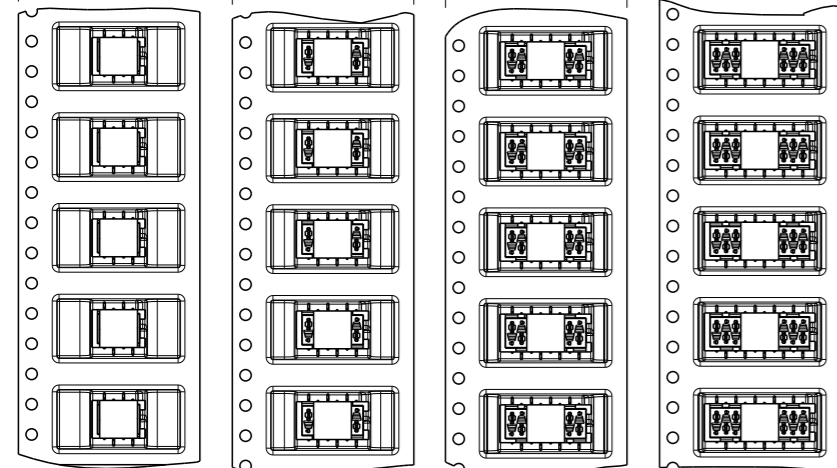

7-2178711-4 4 POSITION 2178711-4
7-2178711-6 6 POSITION 2178711-6
7-2178711-8 8 POSITION 2178711-8
8-2178711-0 10 POSITION 1-2178711-0

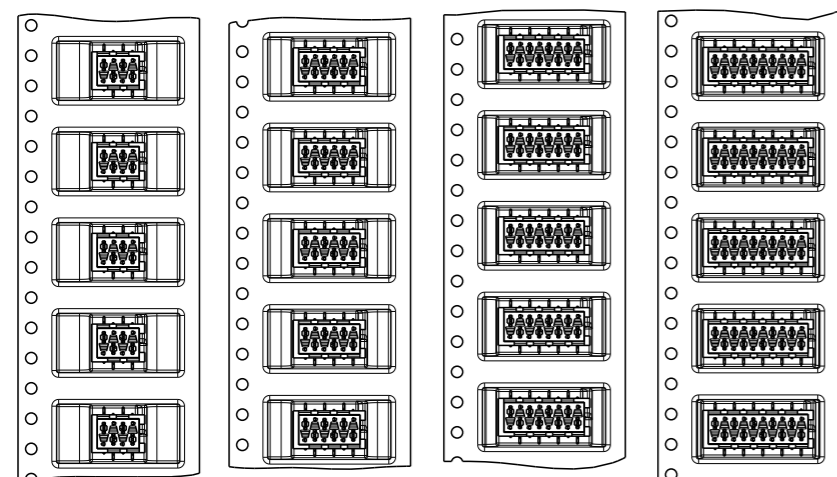

TAPE WIDTH 44 mm

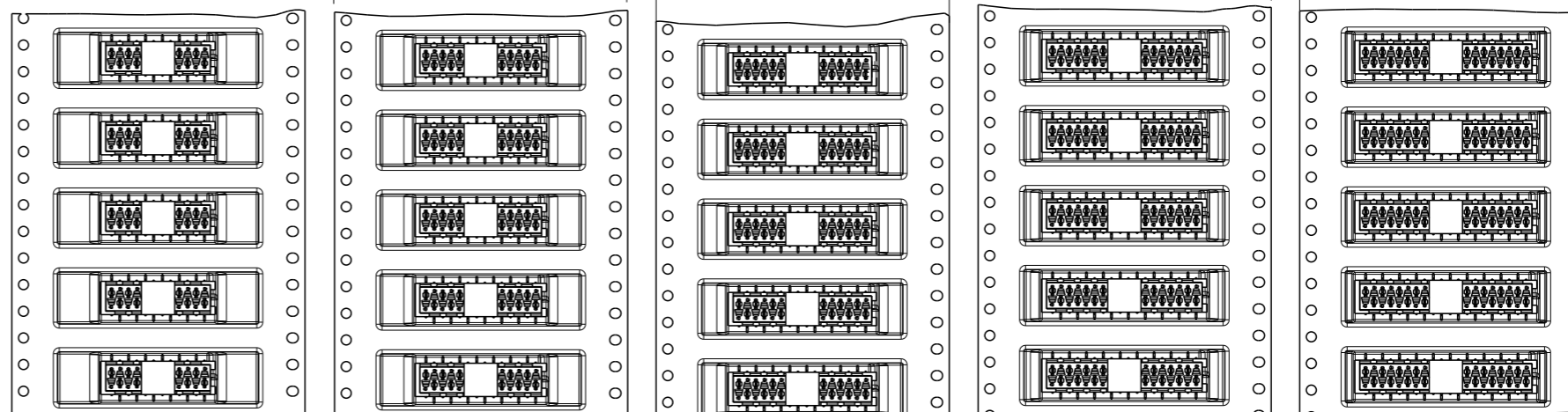

8-2178711-2 12 POSITION 1-2178711-2
8-2178711-4 14 POSITION 1-2178711-4
8-2178711-6 16 POSITION 1-2178711-6
8-2178711-8 18 POSITION 1-2178711-8
9-2178711-0 20 POSITION 2-2178711-0

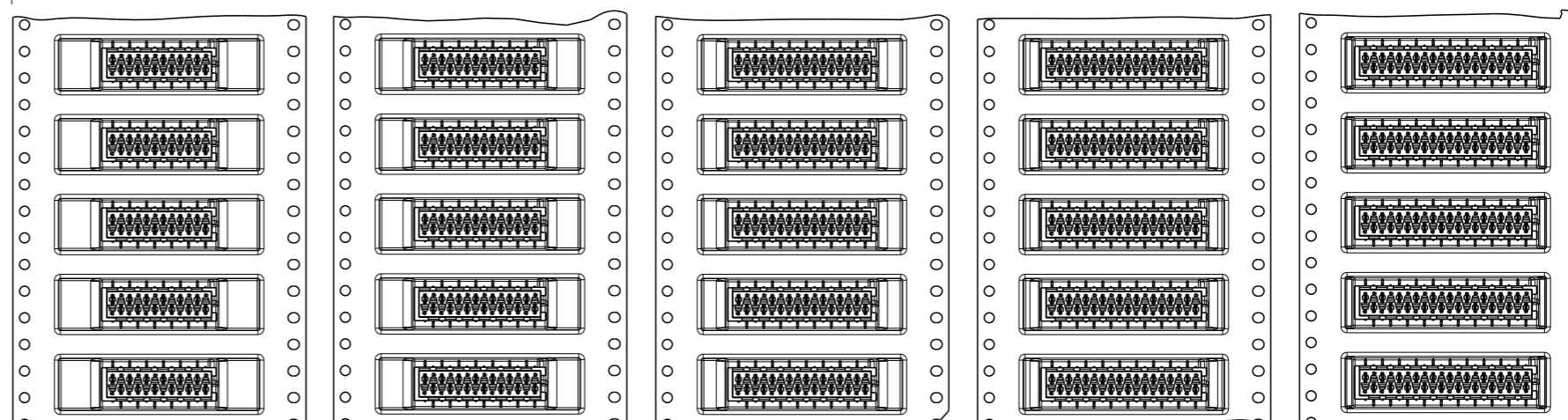

THIS DRAWING IS A CONTROLLED DOCUMENT.

DIMENSIONS: mm

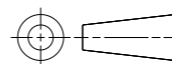

TOLERANCES UNLESS OTHERWISE SPECIFIED:

- 0 PLC ±-
1 PLC ±0.1
2 PLC ±0.05
3 PLC ±-
4 PLC ±-
ANGLES ±-
FINISH -

MATERIAL -

DWN PRASHANTH 25JUL2014
CHK PRASHANTH 05AUG2014
APVD JAYANTH KUMAR 05AUG2014
PRODUCT SPEC 108-32087
APPLICATION SPEC 114-13318
WEIGHT -

CUSTOMER DRAWING



Micro-MaTch VALUE LINE
FEMALE-ON-BOARD, TOP ENTRY,
SMD, CONNECTOR

SIZE CAGE CODE DRAWING NO RESTRICTED TO

A3 00779 C-2178711

SCALE 1:1 SHEET 2 OF 2 REV A

Mouser Electronics

Authorized Distributor

Click to View Pricing, Inventory, Delivery & Lifecycle Information:

[TE Connectivity:](#)

[9-2178711-0](#)