



### FEATURES

- ◆ Efficiency up to 89%
- ◆ Wide input range, 9V-36V
- ◆ Package with Industry Standard Pinout
- ◆ Package Dimension:  
25.4 x25.4 x10.2mm (1.0" x1.0" x0.40")(No HSK)
- ◆ Over voltage protection, hiccup mode
- ◆ Over current protection, hiccup mode
- ◆ Positive or Negative Remote ON/OFF
- ◆ Without tantalum capacitor inside module
- ◆ Operating Temperature range - 40°C to +85°C
- ◆ Input to Output Isolation: 1600VDC
- ◆ RoHS Compliant
- ◆ 3 Years Product Warranty
- ◆ Heat-sink is option
- ◆ UL60950, 2<sup>nd</sup> Edition, 2011-12-19 Recognized
- ◆ EN50155 compliance for Week 1618 datecode afterwards



The S24SE/S24DE series is miniature, isolated 15W DC/DC converters with 1600VDC isolation. The S24SE/S24DE family comes with a host of industry-standard features, such as over current protection, over voltage protection, over temperature protection and remote on/off. An optional heatsink is available for more extreme thermal requirements. All models have an ultra-wide 4:1 input voltage range (9V to 36V). With operating temperature of -40°C to +85°C, it is suitable for customers' critical applications, such as process control and automation, transportation, data communication and telecom equipment, test equipment, medical device and everywhere where space on the PCB is critical.

### Model List

Model Number	Input Voltage (Range) VDC	Output Voltage VDC	Output Current		Input Current (typ input voltage)		Load Regulation mV	Maxcapacitive Load uF	Efficiency (typ.) %
			Max.	Min.	@Max. Load	@No Load			
			mA	mA	mA(typ.)	mA(typ.)			
S24SE3R305	24 (9 ~ 36)	3.3V	4500	0	720	35	±10	10000	87%
S24SE05003		5.0V	3000	0	710	35	±10	10000	89%
S24SE12001		12V	1250	0	720	30	±12	470	87.5%
S24SE150R9		15V	1000	0	720	25	±15	470	87.5%
S24DE120R6		±12V	625	0	720	20	±120	±470	87.5%
S24DE150R5		±15V	500	0	720	30	±150	±470	87.5%

### Input Characteristics

Item	Model	Min.	Typ.	Max.	Unit
Input Surge Voltage (100 msec)	All Models			50	VDC
Input Turn-On Voltage Threshold	All Models	8	8.5	9	VDC
Input Turn-Off Voltage Threshold	All Models	7	7.5	8	VDC
Input Under-Voltage Lockout Hysteresis	All Models	0.4	1	1.7	VDC
Off-Converter Input Current	All Models		6		mA
Input reflected ripple current	All Models, with 12uH, 20MHz		5	20	mA
Reverse Polarity Input Current	All Models	---	---	0.3	A
ON/OFF Control, Logic High	All Models	2.4		10	VDC
ON/OFF Control, Logic Low	All Models	-0.7		0.8	VDC
Input Filter	All Models	Internal PI Filter			

### Output Characteristics

Item	Conditions	Min.	Typ.	Max.	Unit
Output Voltage Accuracy		---	±1.0	±2.0	%Vo
Output Voltage Balance	Dual Output, Balanced Loads	---	±1.0	±2.0	%Vo
Line Regulation	Single output		±0.1	±0.2	%Vo
	Dual output		±0.1	±0.5	%Vo
Cross Regulation	Dual output, Asymmetrical Load 25%-100% Full Load		±2	±3	%Vo
Total Output Voltage Range	Over Load, Line and Temperature	---	---	±3	%Vo
Ripple & Noise	12V, 15V, ±12V, ±15V	---	50	---	mV <sub>P-P</sub>
Ripple & Noise	3.3V, 5.0V		50	---	mV <sub>P-P</sub>
Dynamic load response	50%-75% full load, 0.1A/uS		3		%Vo
Output Over Current Protection	Output Voltage 10% Low, Hiccup	110		160	%Io,max
Short Output Protection	Long Term, Auto-recovery				
Output Over-Voltage Protection	Hiccup, Auto-recovery	115		150	%Vo
Output Trim Range	Single Output	-10		+10	%Vo

### General Characteristics

Item	Conditions	Min.	Typ.	Max.	Unit
I/O Isolation Voltage (rated)		---	---	1600	VDC
I/O Isolation Resistance		10	---	---	MΩ
I/O Isolation Capacitance			1100		pF
Switching Frequency			450		KHz

### Environmental Specifications

Parameter	Conditions	Min.	Max.	Unit
Operating Temperature Range (with Derating)	Ambient	-40	+85	°C
Case Temperature (9Vin / 24Vin / 36Vin)		---	+95 / +105 / +105	°C
NTC Shutdown Temperature			+125	°C
Storage Temperature Range		-55	+125	°C
Humidity (non condensing)		---	95	% rel. H
Cooling		Natural Convection		

### Thermal Derating Curves(No Heat Sink)

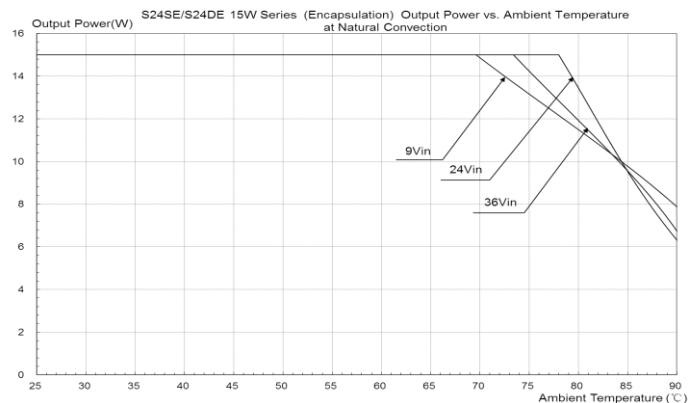

### Notes

- Specifications typical at Ta=+25°C, resistive load, nominal input voltage and rated output current unless otherwise noted.
- Ripple & Noise measurement bandwidth is 0-20MHz, with 10μF, tantalum capacitor and 1μF ceramic capacitor.
- All DC/DC converters should be externally fused at the front end for protection.
- Specifications are subject to change without notice.

### ELECTRICAL CHARACTERISTICS CURVES - S24SE3R305, 9-36VIN, 3.3V/4.5A

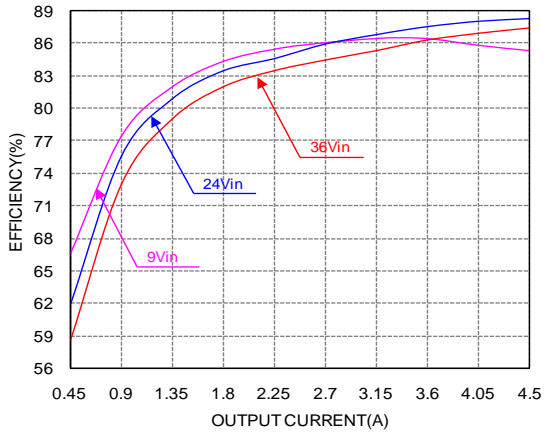

Efficiency vs. load current for various input voltage at 25°C.

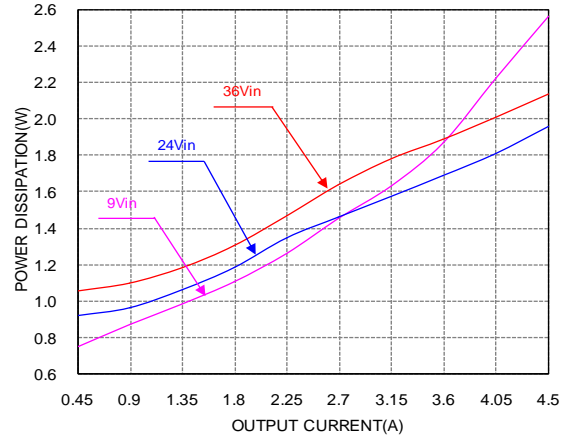

Power dissipation vs. load current at 25°C.

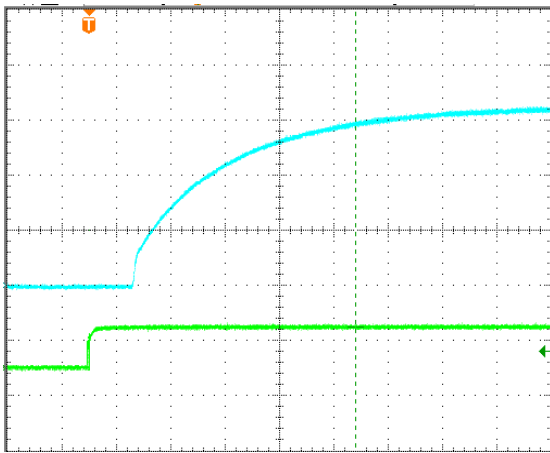

Turn-on transient at full load current (4ms/div).  
Top Trace: Vout; 1V/div; Bottom Trace: ON/OFF input: 5V/div.

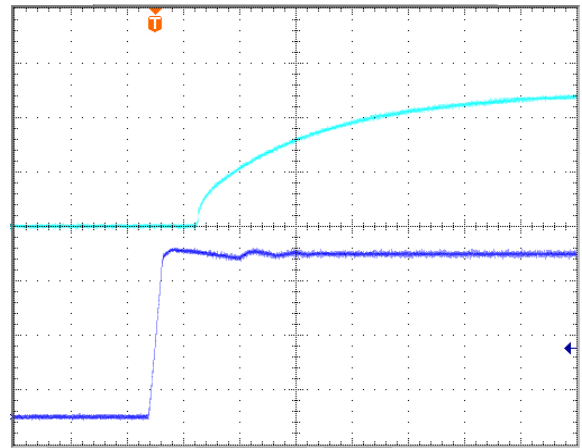

Turn-on transient at full load current (4ms/div).  
Top Trace: Vout; 1V/div; Bottom Trace: input voltage: 20V/div.

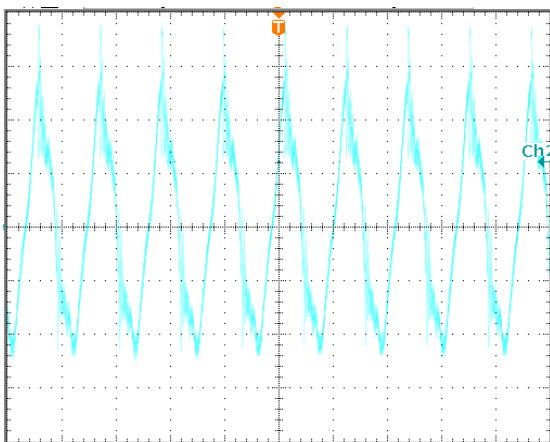

Output voltage ripple at nominal input voltage and max load current (5mV/div, 2us/div)  
Load cap: 10μF, tantalum capacitor and 1μF ceramic capacitor.  
Bandwidth: 20 MHz.

### ELECTRICAL CHARACTERISTICS CURVES - S24SE05003, 9-36VIN, 5.0V/3A

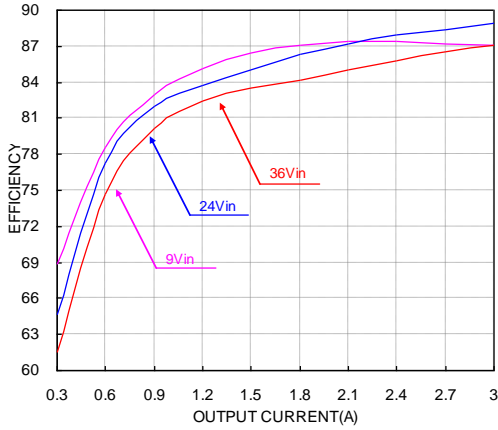

Efficiency vs. load current for various input voltage at 25°C.

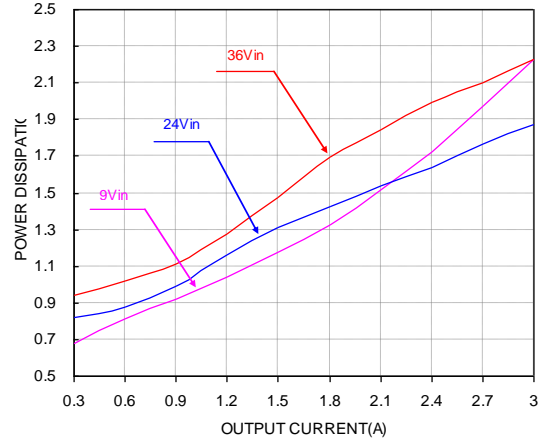

Power dissipation vs. load current at 25°C.

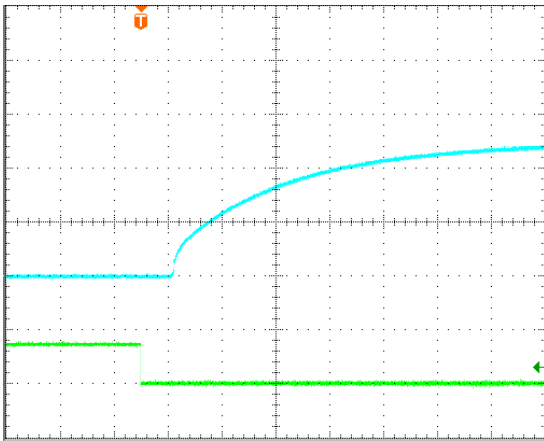

Turn-on transient at full load current (10ms/div).  
Top Trace: Vout; 2V/div; Bottom Trace: ON/OFF input: 5V/div.

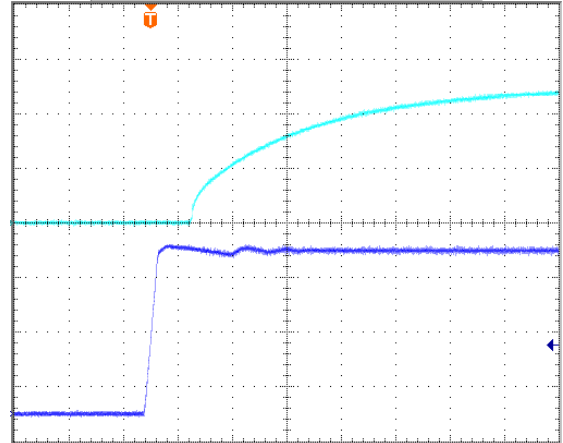

Turn-on transient at full load current (10 ms/div).  
Top Trace: Vout; 2V/div; Bottom Trace: input voltage: 8V/div.

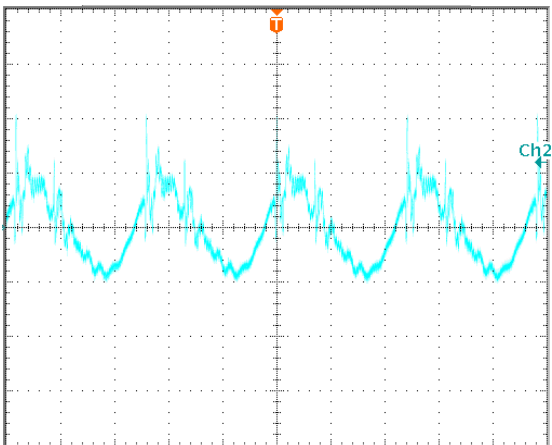

Output voltage ripple at nominal input voltage and max load current (20 mV/div, 2us/div)  
Load cap: 10µF, tantalum capacitor and 1µF ceramic capacitor.  
Bandwidth: 20 MHz.

### ELECTRICAL CHARACTERISTICS CURVES - S24SE12001, 9-36VIN, 12V/1.25A

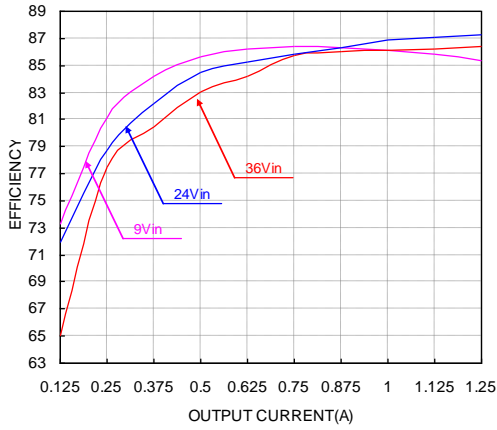

Efficiency vs. load current for various input voltage at 25°C.

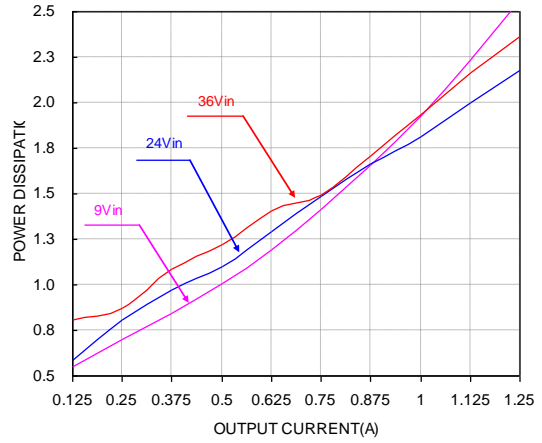

Power dissipation vs. load current at 25°C.

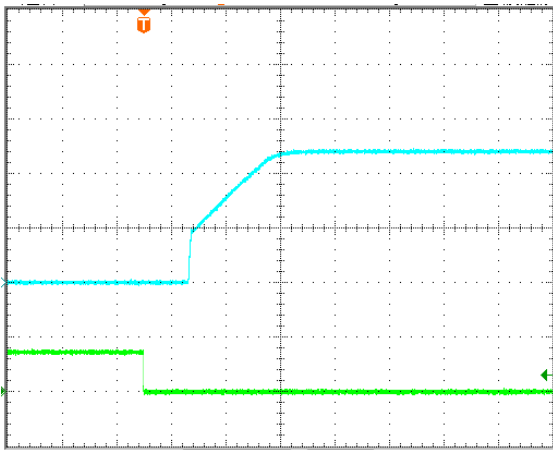

Turn-on transient at full load current (4ms/div).  
Top Trace: Vout; 5V/div; Bottom Trace: ON/OFF input: 5V/div.

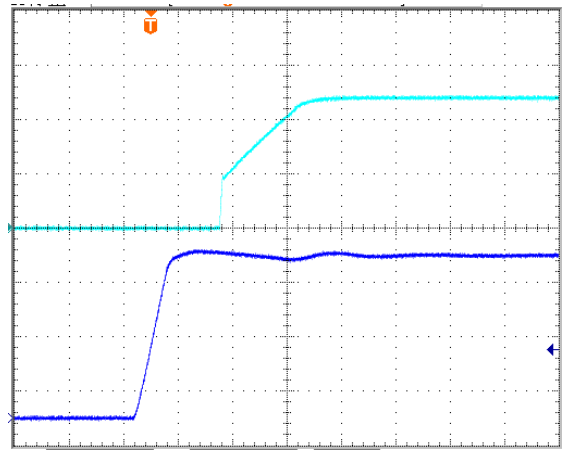

Turn-on transient at full load current (4 ms/div).  
Top Trace: Vout; 5V/div; Bottom Trace: input voltage: 8V/div.

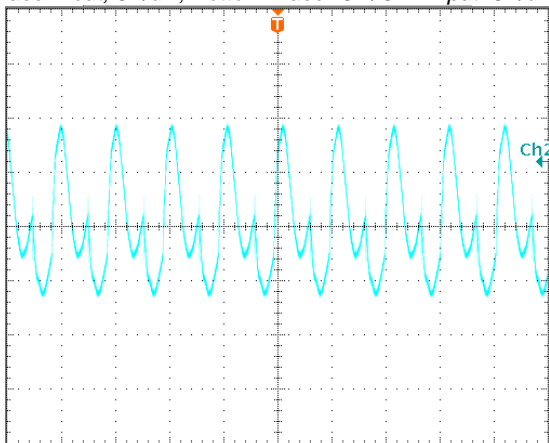

Output voltage ripple at nominal input voltage and max load current (10 mV/div, 2us/div)  
Load cap: 10μF, tantalum capacitor and 1μF ceramic capacitor.  
Bandwidth: 20 MHz.

### ELECTRICAL CHARACTERISTICS CURVES - S24SE150R9, 9-36VIN, 15V/1A

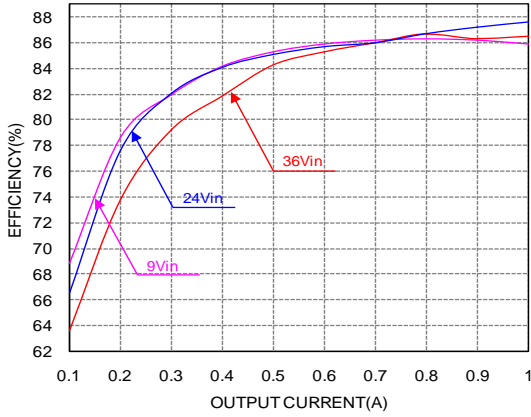

Efficiency vs. load current for various input voltage at 25°C.

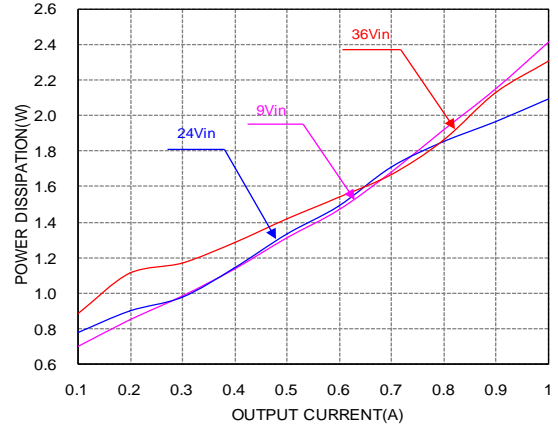

Power dissipation vs. load current at 25°C.

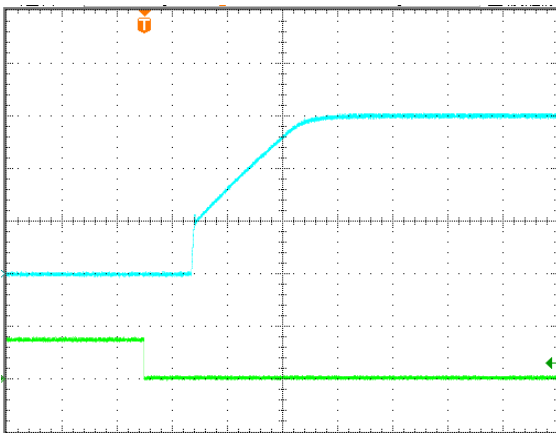

Turn-on transient at full load current (4ms/div).  
Top Trace: Vout; 5V/div; Bottom Trace: ON/OFF input: 5V/div.

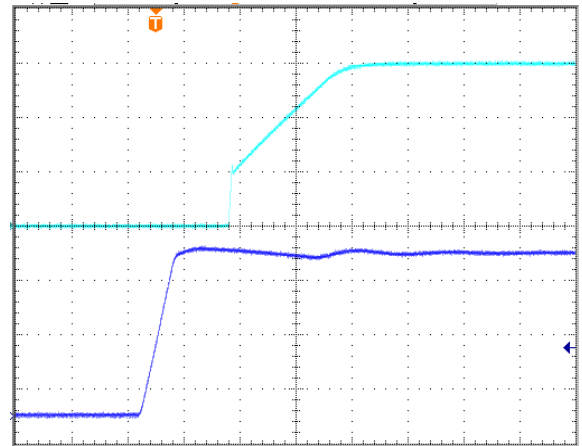

Turn-on transient at full load current (4ms/div).  
Top Trace: Vout; 5V/div; Bottom Trace: input voltage: 8V/div.

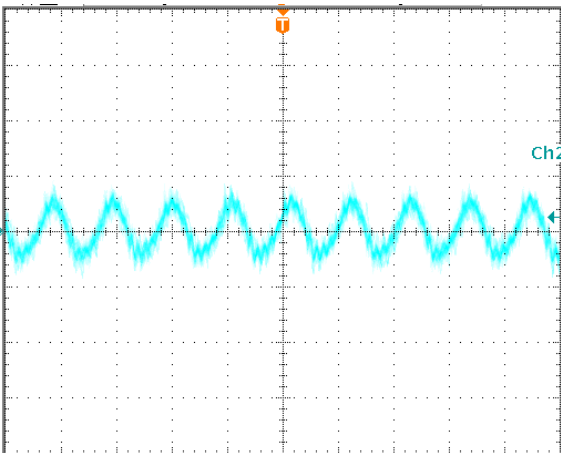

Output voltage ripple at nominal input voltage and max load current (4mV/div, 2us/div)  
Load cap: 10μF, tantalum capacitor and 1μF ceramic capacitor.  
Bandwidth: 20 MHz.

### ELECTRICAL CHARACTERISTICS CURVES - S24DE120R6, 9-36VIN, ±12V/0.625A

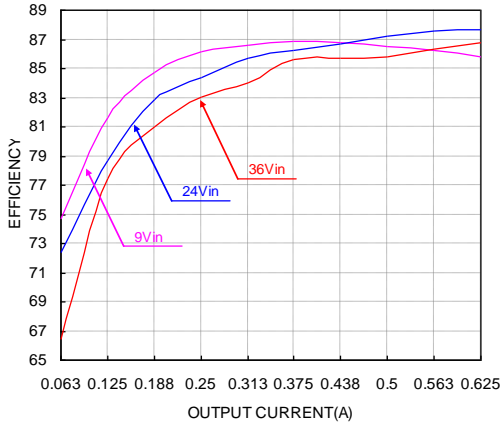

Efficiency vs. load current for various input voltage at 25°C.

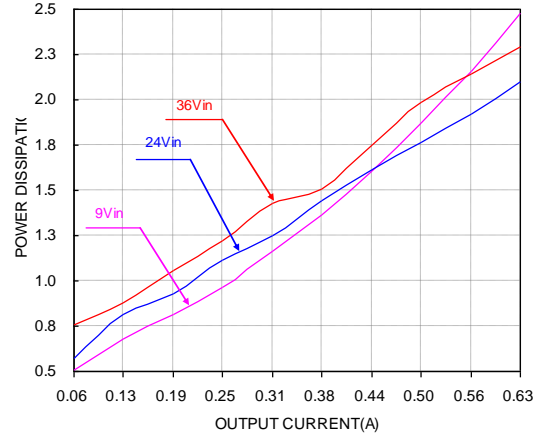

Power dissipation vs. load current at 25°C.

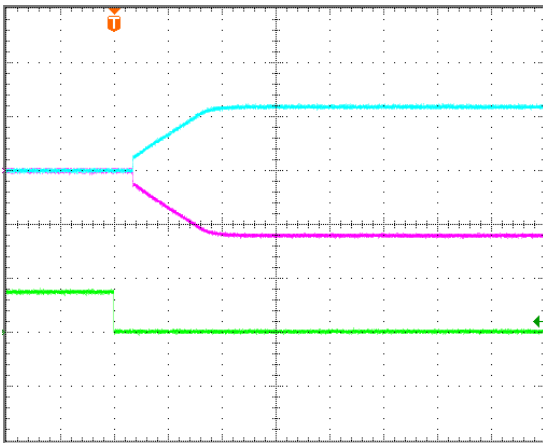

Turn-on transient at full load current (10ms/div).  
Top two Traces: Vout; 10V/div; Bottom Trace: ON/OFF input: 5V/div.

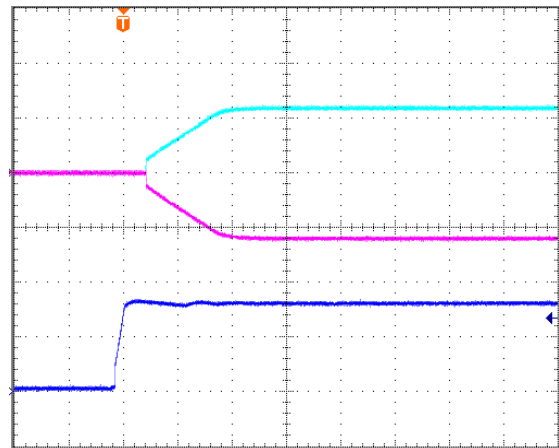

Turn-on transient at full load current (10 ms/div).  
Top two Traces: Vout; 10V/div; Bottom Trace: input voltage: 15V/div.

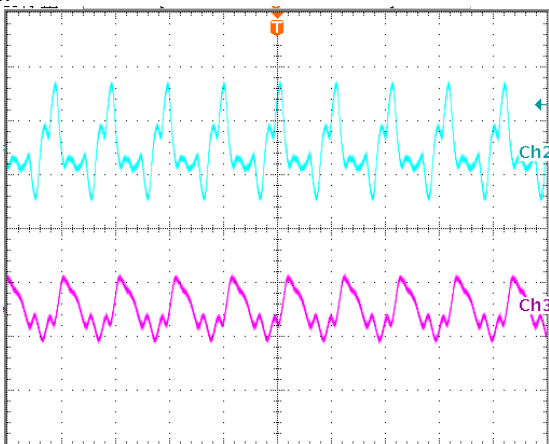

Output voltage ripple at nominal input voltage and max load current Top trace +12V, 10 mV/div, Bottom trace -12V, 20mV/div, 2us/div.  
Load cap: 10μF, tantalum capacitor and 1μF ceramic capacitor.  
Bandwidth: 20 MHz.

### ELECTRICAL CHARACTERISTICS CURVES - S24DE150R5, 9-36VIN, $\pm 15V/0.5A$

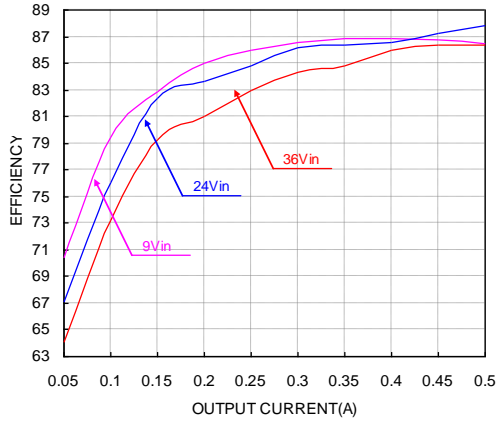

Efficiency vs. load current for various input voltage at 25°C.

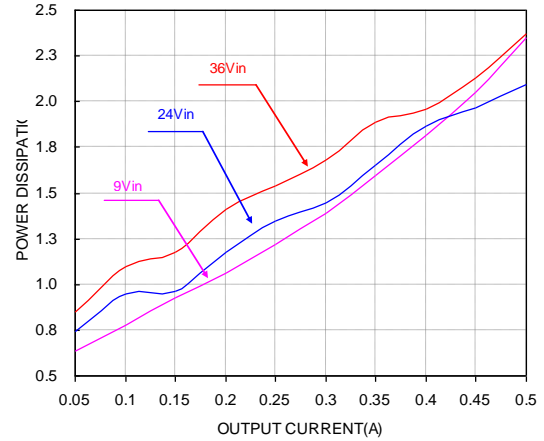

Power dissipation vs. load current at 25°C.

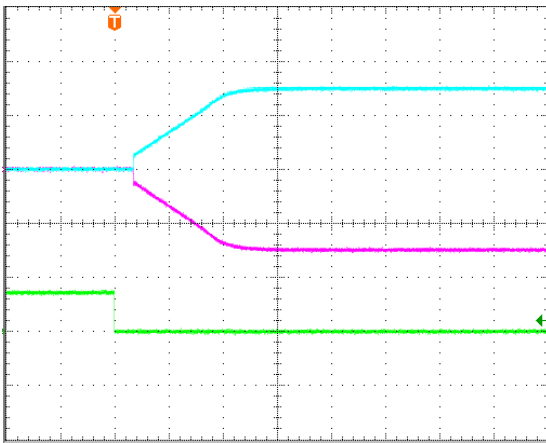

Turn-on transient at full load current (10ms/div).  
Top two traces: Vout; 10V/div; Bottom Trace: ON/OFF input: 5V/div.

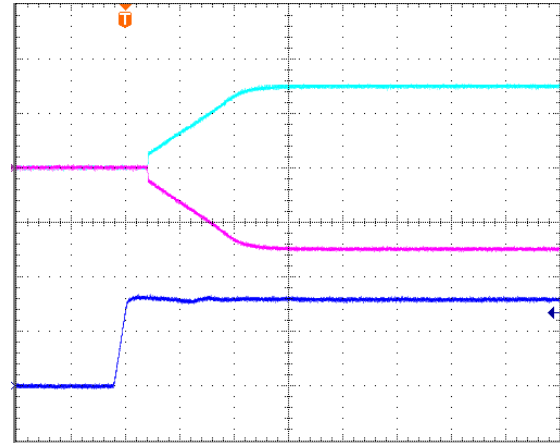

Turn-on transient at full load current (10 ms/div).  
Top two traces: Vout; 10V/div; Bottom Trace: input voltage: 15V/div.

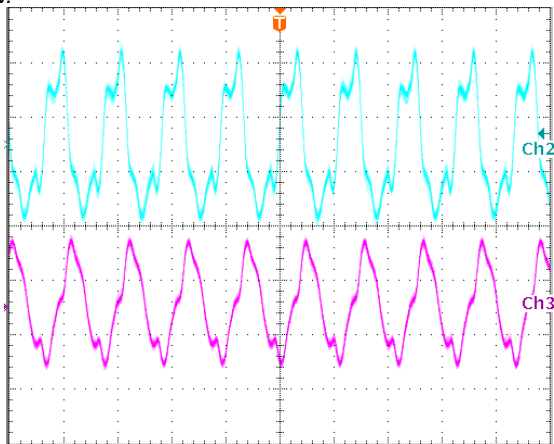

Output voltage ripple at nominal input voltage and max load current Top trace +15V, 10 mV/div, Bottom trace -15V, 20mV/div, 2us/div.

Load cap: 10 $\mu$ F, tantalum capacitor and 1 $\mu$ F ceramic capacitor.  
Bandwidth: 20 MHz.



### DESIGN CONSIDERATIONS

#### Input Source Impedance

The impedance of the input source connecting to the DC/DC power modules will interact with the modules and affect the stability. A low ac-impedance input source is recommended. If the source inductance is more than a few  $\mu\text{H}$ , we advise a  $47\mu\text{F}$  electrolytic capacitor mounted close to the input of the module to improve the stability.

#### Input Reflected Ripple Current

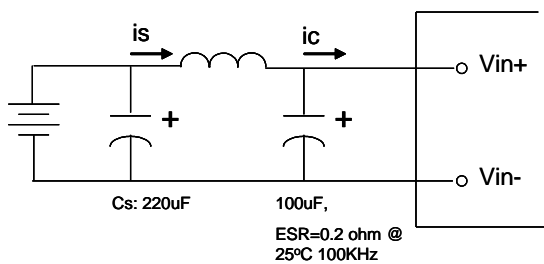

Test set-up diagram showing measurement points for Input Terminal Ripple Current and Input Reflected Ripple Current.

Measured input reflected-ripple current with a simulated source Inductance (LTEST) of  $12\mu\text{H}$ . Capacitor  $C_s$  offset possible battery impedance.

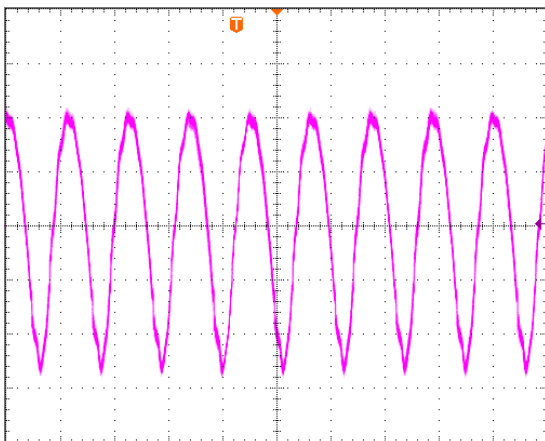

Input Terminal Ripple Current,  $i_c$ , at full rated output current and nominal input voltage with  $12\mu\text{H}$  source impedance and  $100\mu\text{F}$  electrolytic capacitor (25 mA/div, 2 us/div).

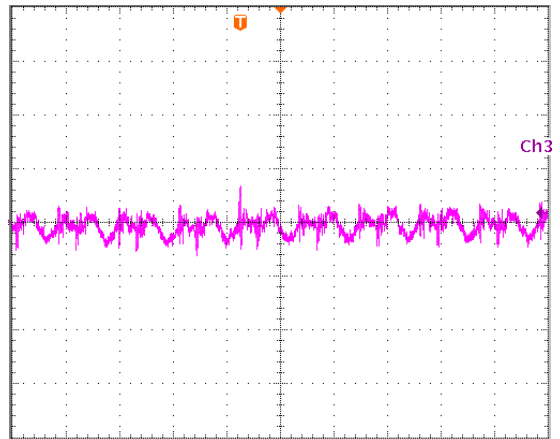

Input reflected ripple current,  $i_s$ , through a  $12\mu\text{H}$  source inductor at nominal input voltage and rated load current (5 mA/div, 2 us/div)

#### Output Ripple Noise

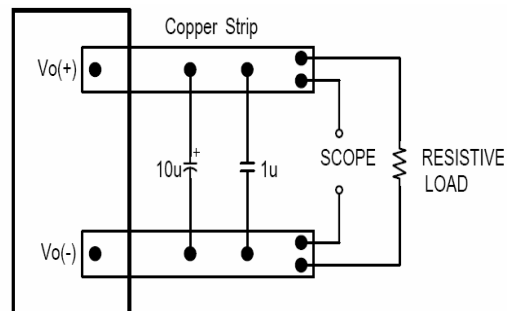

Output voltage ripple test setup.

Load capacitance:  $1\mu\text{F}$  ceramic capacitor and  $10\mu\text{F}$  tantalum capacitor. Bandwidth: 20 MHz. Scope measurements should be made using a BNC cable (length shorter than 20 inches). Position the load between 51 mm to 76 mm (2 inches to 3 inches) from the module.

### DESIGN CONSIDERATIONS

#### Layout and EMI considerations

Delta's DC/DC power modules are designed to operate in a wide variety of systems and applications. For design assistance with EMC compliance and related PWB layout issues, please contact Delta's technical support team. An external input filter module is available for easier EMC compliance design. Below is the reference design for an input filter to pass EN55022 (VDE0878) class A (both q. peak and average).

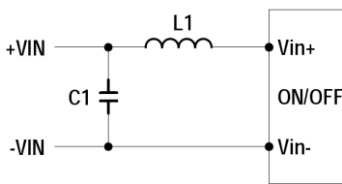

L1=1uH  
C1=47uF/50V, electrolytic capacitor

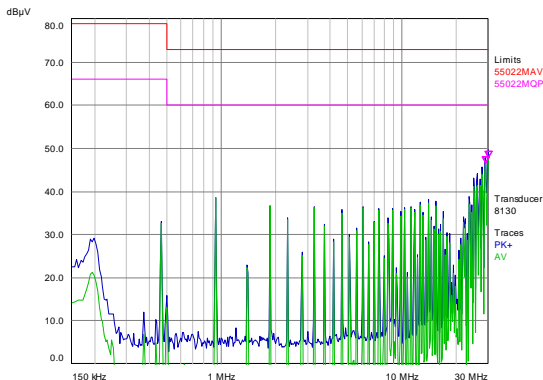

Test Result:

At T = +25°C , Typical input voltage and full load.

Green is quasi peak mode; Blue is average mode.

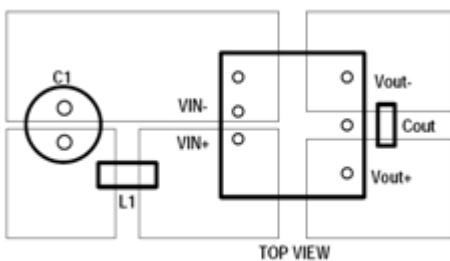

#### Recommended PCB Layout

It is suggested to use multiple layers PCB and large size copper on system board which connects to pins of module, that can achieve better thermal performance.

### FEATURES DESCRIPTIONS

#### Over-Current Protection

The modules include an internal output over-current protection circuit, which will endure current limiting for an unlimited duration during output overload. If the output current exceeds the OCP set point, the modules will shut down (hiccup mode).

The modules will try to restart after shutdown. If the overload condition still exists, the module will shut down again. This restart trial will continue until the overload condition is corrected.

#### Over-Voltage Protection

The modules include an internal output over-voltage protection circuit, which monitors the voltage on the output terminals. If this voltage exceeds the over-voltage set point, the modules will shut down, and then restart after a hiccup-time (hiccup mode).

If latch mode is needed, please contact with Delta.

#### Over-Temperature Protection

The over-temperature protection consists of circuitry that provides protection from thermal damage. If the temperature exceeds the over-temperature threshold the module will shut down. The module will restart after the temperature is within specification.

#### Remote On/Off

The remote on/off feature on the module can be either negative or positive logic depend on the part number options on the last page.

- ❖ For Negative logic version, turns the module on during a external logic low and off during a logic high. If the remote on/off feature is not used, please short the on/off pin to Vi (-).
- ❖ For Postive logic version, turns the modules on during a external logic high and off during a logic low. If the remote on/off feature is not used, please leave the on/off pin to floating.

Remote on/off can be controlled by an external switch between the on/off terminal and the Vi (-) terminal. The switch can be an open collector or open drain.

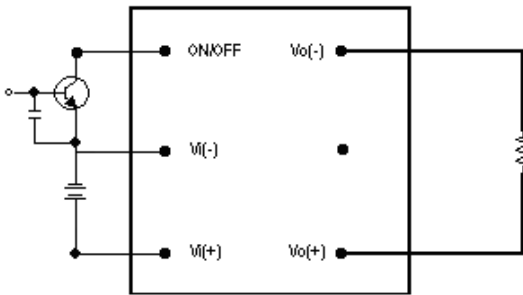

Remote on/off implementation

### Output Voltage Adjustment (TRIM)

Only single output modules have output adjust function.

To increase the output voltage set point, connect an external resistor between the TRIM pin and the Vout(-).

To decrease the output voltage set point, connect an external resistor between the TRIM pin and the Vout(+).

The maximum adjust range is  $\pm 10\%$ , the TRIM pin should be left open if this feature is not used.

For 3.3V single output (Kohm):

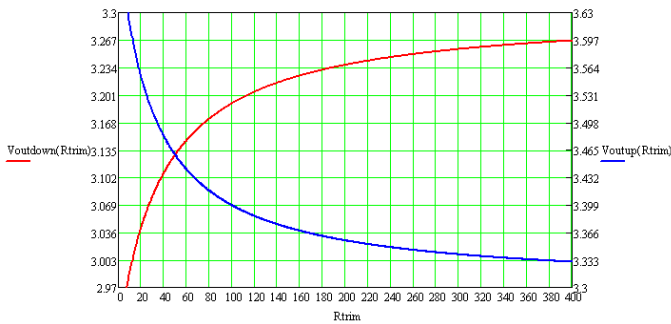

For 5V single output (Kohm):

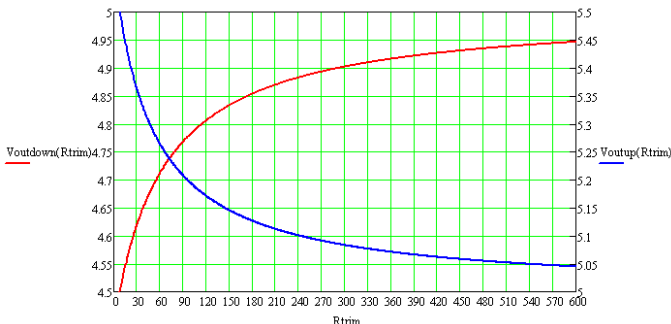

For 12V single output (Kohm):

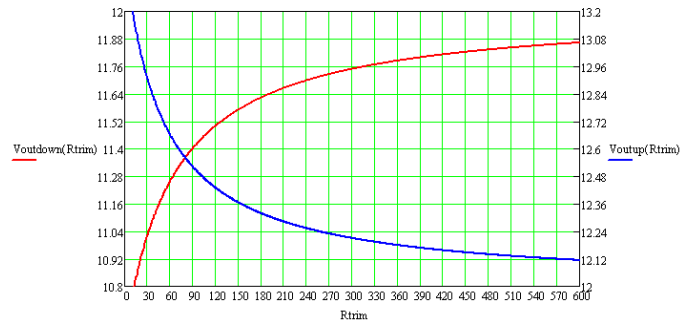

For 15V single output (Kohm):

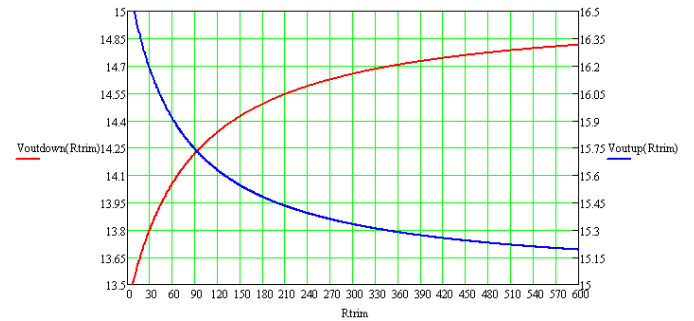

For example:

When need trim up to 3.4V, then the external resistor should be 100 Kohm between trim pin and Vout- pin.

When need trim down to 3.1V, then the external resistor should be 40Kohm between trim pin and Vout+ pin.

### THERMAL CONSIDERATIONS

Thermal de-rating curve is a standard for customer to make thermal evaluation and make sure the module's components are operated under allowed temperature. The module's cooling condition is natural convection. In thermal de-rating curve, if we know the module's input voltage and output power we can find the allowed maximum ambient temperature.

The module's case temperature is a reference to make thermal evaluation. If the case temperature exceed the allowed maximum value, the module may probably have thermal issue.

### Mechanical Drawing

#### Mechanical Dimensions

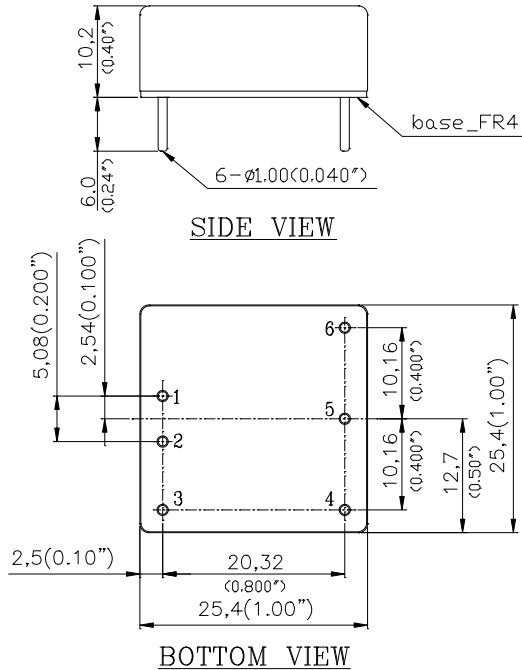

#### Pin Connections

Pin	Single Output Function	Dual Output Function
1	Vin+	Vin+
2	Vin-	Vin-
3	On/off	On/off
4	Vout-	Vout-
5	Trim	Common
6	Vout+	Vout+

#### Physical outline

Case Size: 25.4\*25.4\*9.5(1.0"\*1.0"\*0.38")

Case material: Al alloy, anodize black

Baseplate material: Non-conductive FR-4

Pin material: Brass; finish: Matte Tin plating and Nickel under plating

Pin length: refer part numbering system

Weight: 18.0grams

- All dimensions in mm (inches)
- Tolerance: X.X±0.5 (X.XX±0.02)  
X.XX±0.25 ( X.XXX±0.010)
- Pins Diameter : ±0.10(±0.004)

### Mechanical Drawing with heat sink(optional)

#### Mechanical Dimensions

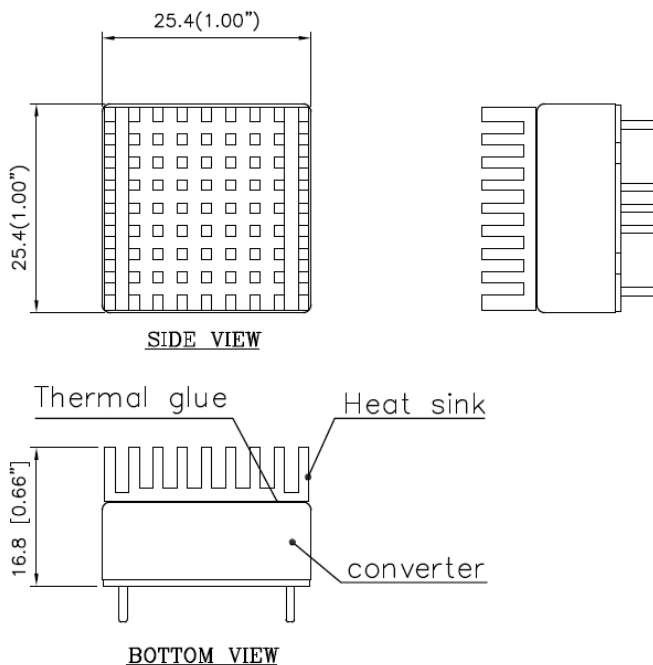

#### Physical Outline

1	Heat sink
	Material: Al-6063
	Finish: anodize black
	Weight: 4.0grams
2	Model weight: 22.2 grams

- All dimensions in mm (inches)
- Tolerance: X.X±0.5 (X.XX±0.02)  
X.XX±0.25 ( X.XXX±0.010)

#### Note:

1. add heat sink to help heat dissipation and increase reliability of convert operating at high ambient temperature
2. please refer derating curve while upgrade the operating temperature of converter

**Application notice:**

For modules with through-hole pins, they are intended for wave soldering assembly onto system boards; please do not subject such modules through reflow temperature profile.

Recommended layout refer below

### RECOMMENDED LAYOUT

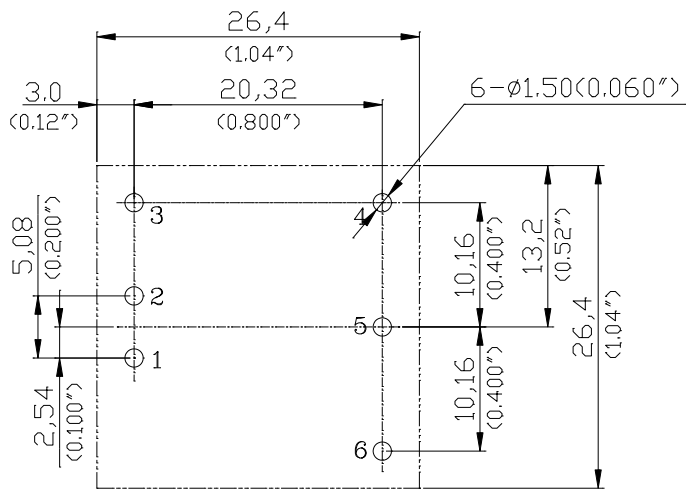

PIN	Single	Dual
1	Vin(+)	Vin(+)
2	Vin(-)	Vin(-)
3	ON/OFF	ON/OFF
4	Vout(-)	Vout(-)
5	Trim	Comm
6	Vout(+)	Vout(+)

### Part Numbering System

S	24	S	E	050	03	N	D	F	A
Form factor	Input voltage	Number of output	Product series	Output voltage	Output current	On/off logic	Pin length		Option Code
S	24 - 9~36V	S - Single D - Dual	E - Series No.	050 - 5.0V	03 - 3A	N - Negative	D - 0.24"	F - RoHS 6/6 (Lead Free)	A - Standard. (with metal case)
						P - Positive	T - 0.22"		H - With heat sink
							R - 0.17"		

**CONTACT:** [www.deltaww.com/dcdc](http://www.deltaww.com/dcdc)

**USA:**

Telephone:  
East Coast: 978-656-3993  
West Coast: 510-668-5100  
Fax: (978) 656 3964

**Email:** [dcdc@deltaww.com](mailto:dcdc@deltaww.com)

**Europe:**

Phone: +31-20-655-0967  
Fax: +31-20-655-0999

**Asia & the rest of world:**

Telephone: +886 3 4526107  
ext 6220~6224  
Fax: +886 3 4513485

**WARRANTY**

Delta offers a three (3) years limited warranty. Complete warranty information is listed on our web site or is available upon request from Delta.

Information furnished by Delta is believed to be accurate and reliable. However, no responsibility is assumed by Delta for its use, nor for any infringements of patents or other rights of third parties, which may result from its use. No license is granted by implication or otherwise under any patent or patent rights of Delta. Delta reserves the right to revise these specifications at any time, without notice.

# Mouser Electronics

Authorized Distributor

Click to View Pricing, Inventory, Delivery & Lifecycle Information:

## Delta Electronics:

[S24DE150R5PDFA](#) [S24SE3R305PDFA](#) [S24SE150R9PDFA](#) [S24SE05003PDFA](#) [S24SE12001PDFA](#)  
[S24DE120R6PDFA](#) [S24SE05003NDFA](#) [S24DE120R6NDFA](#) [S24SE12001NDFA](#) [S24DE150R5NDFA](#)  
[S24SE150R9NDFA](#) [S24SE3R305NDFA](#) [S24DE120R6NPFA](#) [S24DE120R6NTFA](#) [S24DE120R6PRFA](#)  
[S24DE120R6PTFA](#) [S24DE150R5NPFA](#) [S24SE3R305PTFA](#) [S24SE150R9NTFA](#) [S24SE150R9PRFA](#)  
[S24SE150R9PTFA](#) [S24SE3R305NPFA](#) [S24SE3R305NTFA](#) [S24SE3R305PRFA](#) [S24SE05003PTFA](#)  
[S24SE12001NPFA](#) [S24SE12001NTFA](#) [S24SE12001PRFA](#) [S24SE12001PTFA](#) [S24SE150R9NPFA](#)  
[S24DE150R5NTFA](#) [S24DE150R5PRFA](#) [S24DE150R5PTFA](#) [S24SE05003NPFA](#) [S24SE05003NTFA](#)  
[S24SE05003PRFA](#)