



200MHz, CMOS OPERATIONAL AMPLIFIER

FEATURES

- UNITY-GAIN BANDWIDTH: 450MHz
- WIDE BANDWIDTH: 200MHz GBW
- HIGH SLEW RATE: 360V/ μ s
- LOW NOISE: 5.8nV/ $\sqrt{\text{Hz}}$
- EXCELLENT VIDEO PERFORMANCE:
DIFF GAIN: 0.02%, DIFF PHASE: 0.05°
0.1dB GAIN FLATNESS: 75MHz
- INPUT RANGE INCLUDES GROUND
- RAIL-TO-RAIL OUTPUT (within 100mV)
- LOW INPUT BIAS CURRENT: 3pA
- THERMAL SHUTDOWN
- SINGLE-SUPPLY OPERATING RANGE: 2.5V to 5.5V
- *Micro*SIZE PACKAGES

APPLICATIONS

- VIDEO PROCESSING
- ULTRASOUND
- OPTICAL NETWORKING, TUNABLE LASERS
- PHOTODIODE TRANSIMPEDANCE AMPS
- ACTIVE FILTERS
- HIGH-SPEED INTEGRATORS
- ANALOG-TO-DIGITAL (A/D) CONVERTER
INPUT BUFFERS
- DIGITAL-TO-ANALOG (D/A) CONVERTER
OUTPUT AMPLIFIERS
- BARCODE SCANNERS
- COMMUNICATIONS

DESCRIPTION

The OPAx356 series high-speed, voltage-feedback CMOS operational amplifiers are designed for video and other applications requiring wide bandwidth. The OPAx356 is unity gain stable and can drive large output currents. Differential gain is 0.02% and differential phase is 0.05°. Quiescent current is only 8.3mA per channel.

OPAx356 is optimized for operation on single or dual supplies as low as 2.5V ($\pm 1.25\text{V}$) and up to 5.5V ($\pm 2.75\text{V}$). Common-mode input range for the OPAx356 extends 100mV below ground and up to 1.5V from V+. The output swing is within 100mV of the rails, supporting wide dynamic range.

The OPAx356 series is available in single (SOT23-5 and SO-8), and dual (MSOP-8 and SO-8) versions. Multichannel versions feature completely independent circuitry for lowest crosstalk and freedom from interaction. All are specified over the extended -40°C to $+125^{\circ}\text{C}$ range.

OPA356 RELATED PRODUCTS

FEATURES	PRODUCT
200MHz, Rail-to-Rail Output, CMOS, Shutdown	OPA355
38MHz, Rail-to-Rail Input/Output, CMOS	OPA350
75MHz, Rail-to-Rail Output	OPA631
150MHz, Rail-to-Rail Output	OPA634
Differential Input/Output, 3.3V Supply	THS412x

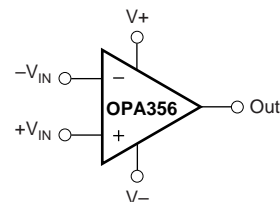

Please be aware that an important notice concerning availability, standard warranty, and use in critical applications of Texas Instruments semiconductor products and disclaimers thereto appears at the end of this data sheet.

ABSOLUTE MAXIMUM RATINGS⁽¹⁾

Supply Voltage, V+ to V-	7.5V
Signal Input Terminals, Voltage ⁽²⁾	(V-) - 0.5V to (V+) + 0.5V
Current ⁽²⁾	10mA
Output Short-Circuit ⁽³⁾	Continuous
Operating Temperature	-55°C to +150°C
Storage Temperature	-65°C to +150°C
Junction Temperature	+160°C
Lead Temperature (soldering, 10s)	+300°C

NOTE: (1) Stresses above these ratings may cause permanent damage. Exposure to absolute maximum conditions for extended periods may degrade device reliability. These are stress ratings only, and functional operation of the device at these or any other conditions beyond those specified is not implied. (2) Input terminals are diode-clamped to the power-supply rails. Input signals that can swing more than 0.5V beyond the supply rails should be current limited to 10mA or less. (3) Short-circuit to ground one amplifier per package.



ELECTROSTATIC DISCHARGE SENSITIVITY

This integrated circuit can be damaged by ESD. Texas Instruments recommends that all integrated circuits be handled with appropriate precautions. Failure to observe proper handling and installation procedures can cause damage.

ESD damage can range from subtle performance degradation to complete device failure. Precision integrated circuits may be more susceptible to damage because very small parametric changes could cause the device not to meet its published specifications.

PACKAGE/ORDERING INFORMATION

PRODUCT	PACKAGE-LEAD	PACKAGE DESIGNATOR ⁽¹⁾	SPECIFIED TEMPERATURE RANGE	PACKAGE MARKING	ORDERING NUMBER ⁽²⁾	TRANSPORT MEDIA, QUANTITY
OPA356AIDBV	SOT23-5	DBV	-40°C to +125°C	OAAI	OPA356AIDBVT	Tape and Reel, 250
"	"	"	"	"	OPA356AIDBVR	Tape and Reel, 3000
OPA356AID	SO-8	D	-40°C to +125°C	OPA356A	OPA356AID	Rails, 100
"	"	"	"	"	OPA356AIDR	Tape and Reel, 2500
OPA2356AIDGK	MSOP-8	DGK	-40°C to +125°C	AYI	OPA2356AIDGKT	Tape and Reel, 250
"	"	"	"	"	OPA2356AIDGKR	Tape and Reel, 2500
OPA2356AID	SO-8	D	-40°C to +125°C	OPA2356A	OPA2356AID	Rails, 100
"	"	"	"	"	OPA2356AIDR	Tape and Reel, 2500

NOTES: (1) For the most current specifications and package information, refer to our web site at www.ti.com. (2) Models labeled with "T" indicate smaller quantity tape and reel, "R" indicates large quantity tape and reel and "D" indicates rails of specified quantity.

PIN CONFIGURATIONS

Top View

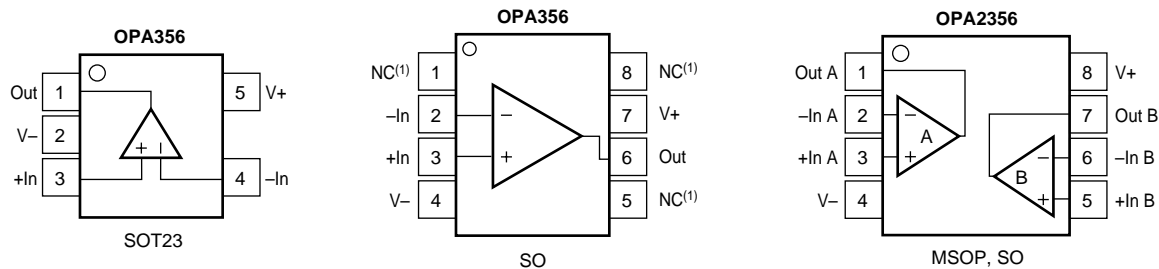

NOTE: (1) NC means no internal connection.

ELECTRICAL CHARACTERISTICS: $V_S = +2.7V$ to $+5.5V$ Single Supply

Boldface limits apply over the specified temperature range, $T_A = -40^\circ C$ to $+125^\circ C$.

At $T_A = +25^\circ C$, $R_F = 604\Omega$, $R_L = 150\Omega$, Connected to $V_S/2$, unless otherwise noted.

PARAMETER	CONDITION	OPA356AIDBV, AID, OPA2356AIDGK, AID			UNITS
		MIN	TYP	MAX	
OFFSET VOLTAGE					
Input Offset Voltage	V_{OS}		± 2	± 9	mV
vs Temperature	dV_{OS}/dT		± 7	± 15	mV/ $^\circ C$
vs Power Supply	PSRR	$V_S = +2.7V$ to $+5.5V$, $V_{CM} = V_S/2 - 0.15V$	± 80	± 350	$\mu V/V$
INPUT BIAS CURRENT					
Input Bias Current	I_B		3	± 50	pA
Input Offset Current	I_{OS}		± 1	± 50	pA
NOISE					
Input Noise Voltage Density	e_n	$f = 1MHz$	5.8		nV/\sqrt{Hz}
Current Noise Density	i_n	$f = 1MHz$	50		fA/\sqrt{Hz}
INPUT VOLTAGE RANGE					
Common-Mode Voltage Range	V_{CM}		$(V-) - 0.1$	$(V+) - 1.5$	V
Common-Mode Rejection Ratio	CMRR	$V_S = +5.5V$, $-0.1V < V_{CM} < +4.0V$	66	80	dB
		Specified Temperature Range	66		dB
INPUT IMPEDANCE					
Differential			$10^{13} \parallel 1.5$		$\Omega \parallel pF$
Common-Mode			$10^{13} \parallel 1.5$		$\Omega \parallel pF$
OPEN-LOOP GAIN					
	OPA356	$V_S = +5V$, $0.3V < V_O < 4.7V$	84	92	dB
	OPA2356	$V_S = +5V$, $0.3V < V_O < 4.7V$	80		dB
		$V_S = +5V$, $0.4V < V_O < 4.6V$	80		dB
FREQUENCY RESPONSE					
Small-Signal Bandwidth	f_{-3dB}	$G = +1$, $V_O = 100mVp-p$, $R_F = 0\Omega$	450		MHz
	f_{-3dB}	$G = +2$, $V_O = 100mVp-p$, $R_L = 50\Omega$	100		MHz
	f_{-3dB}	$G = +2$, $V_O = 100mVp-p$, $R_L = 150\Omega$	170		MHz
	f_{-3dB}	$G = +2$, $V_O = 100mVp-p$, $R_L = 1k\Omega$	200		MHz
Gain-Bandwidth Product	GBW	$G = +10$, $R_L = 1k\Omega$	200		MHz
Bandwidth for 0.1dB Gain Flatness	$f_{0.1dB}$	$G = +2$, $V_O = 100mVp-p$, $R_F = 560\Omega$	75		MHz
Slew Rate	SR	$V_S = +5V$, $G = +2$, 4V Output Step	300/-360		V/ μs
Rise-and-Fall Time		$G = +2$, $V_O = 200mVp-p$, 10% to 90%	2.4		ns
		$G = +2$, $V_O = 2Vp-p$, 10% to 90%	8		ns
Settling Time, 0.1%		$V_S = +5V$, $G = +2$, 2V Output Step	30		ns
0.01%		$V_S = +5V$, $G = +2$, 2V Output Step	120		ns
Overload Recovery Time		$V_{IN} \cdot Gain = V_S$	8		ns
Harmonic Distortion					
2 nd Harmonic		$G = +2$, $f = 1MHz$, $V_O = 2Vp-p$, $R_L = 200\Omega$	-81		dBc
3 rd Harmonic		$G = +2$, $f = 1MHz$, $V_O = 2Vp-p$, $R_L = 200\Omega$	-93		dBc
Differential Gain Error		NTSC, $R_L = 150\Omega$	0.02		%
Differential Phase Error		NTSC, $R_L = 150\Omega$	0.05		degrees
Channel-to-Channel Crosstalk	OPA2356	$f = 5MHz$	-90		dB
OUTPUT					
Voltage Output Swing from Rail		$V_S = +5V$, $R_L = 150\Omega$, $A_{OL} > 84dB$	0.2	0.3	V
Voltage Output Swing from Rail		$V_S = +5V$, $R_L = 1k\Omega$	0.1		V
Voltage Output Swing from Rail		$I_O = \pm 100mA$	0.8	1	V
Output Current, Continuous ⁽¹⁾	I_O		± 60		mA
Maximum Output Current, Peak ⁽¹⁾	I_O	$V_S = +5V$	± 100		mA
Maximum Output Current, Peak ⁽¹⁾	I_O	$V_S = +3V$		± 80	mA
Short Circuit Current				+250/-200	mA
Closed-Loop Output Impedance		$f < 100kHz$		0.02	Ω
POWER SUPPLY					
Specified Voltage Range	V_S		2.7	5.5	V
Operating Voltage Range				2.5 to 5.5	V
Quiescent Current (per amplifier)	I_Q	$V_S = +5V$, $I_O = 0$		8.3	mA
		Specified Temperature Range		14	mA

ELECTRICAL CHARACTERISTICS: $V_S = +2.7V$ to $+5.5V$ Single Supply (Cont.)

Boldface limits apply over the specified temperature range, $T_A = -40^{\circ}C$ to $+125^{\circ}C$.

At $T_A = +25^{\circ}C$, $R_F = 604\Omega$, $R_L = 150\Omega$, Connected to $V_S/2$, unless otherwise noted.

PARAMETER	CONDITION	OPA356AIDBV, AID, OPA2356AIDGK, AID			UNITS
		MIN	TYP	MAX	
THERMAL SHUTDOWN					
Junction Temperature					$^{\circ}C$
Shutdown			160		$^{\circ}C$
Reset from Shutdown			140		$^{\circ}C$
TEMPERATURE RANGE					
Specified Range		-40		125	$^{\circ}C$
Operating Range		-55		150	$^{\circ}C$
Storage Range		-65		150	$^{\circ}C$
Thermal Resistance	θ_{JA}				$^{\circ}C/W$
SOT23-5, MSOP-8			150		$^{\circ}C/W$
SO-8			125		$^{\circ}C/W$

NOTES: (1) See typical characteristic "Output Voltage Swing vs Output Current".

TYPICAL CHARACTERISTICS

At $T_A = +25^\circ\text{C}$ and $V_S = 5\text{V}$, $G = +2$, $R_F = 604\Omega$, $R_L = 150\Omega$ connected to $V_S/2$, unless otherwise noted.

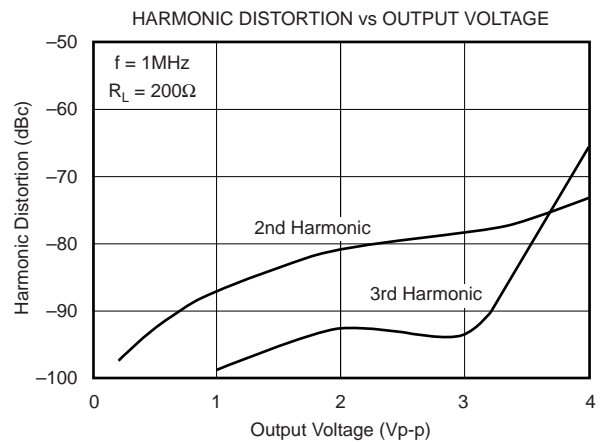
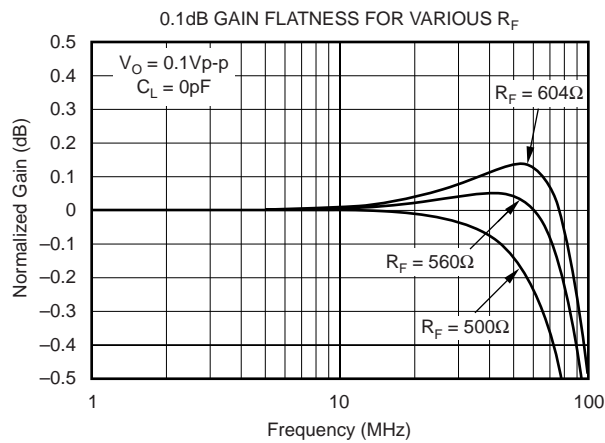
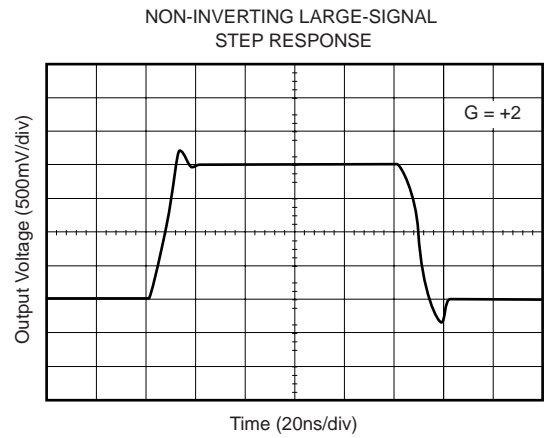
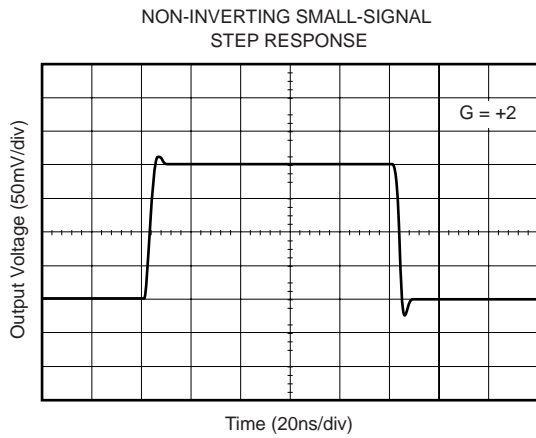
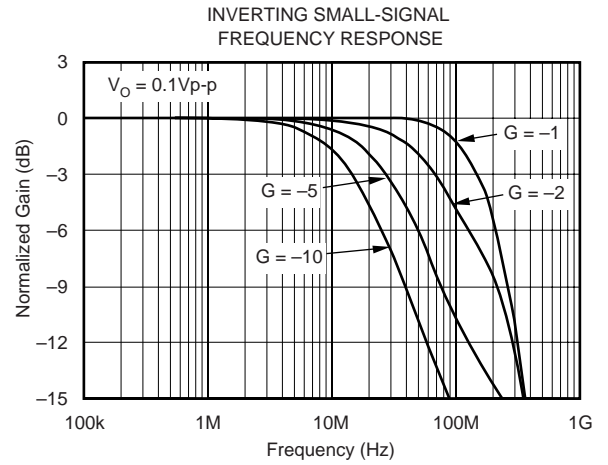
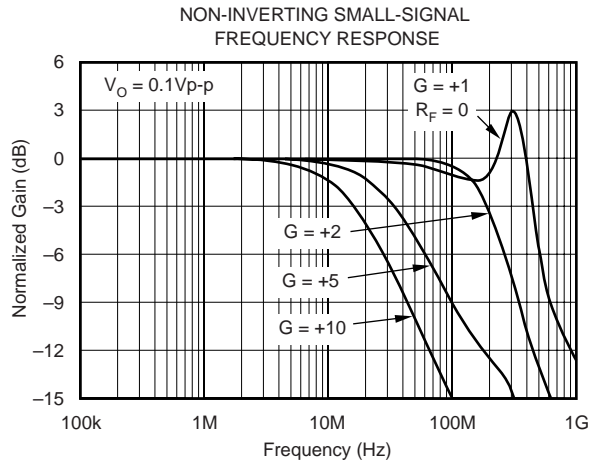

TYPICAL CHARACTERISTICS (Cont.)

At $T_A = +25^\circ\text{C}$ and $V_S = 5\text{V}$, $G = +2$, $R_F = 604\Omega$, $R_L = 150\Omega$ connected to $V_S/2$, unless otherwise noted.

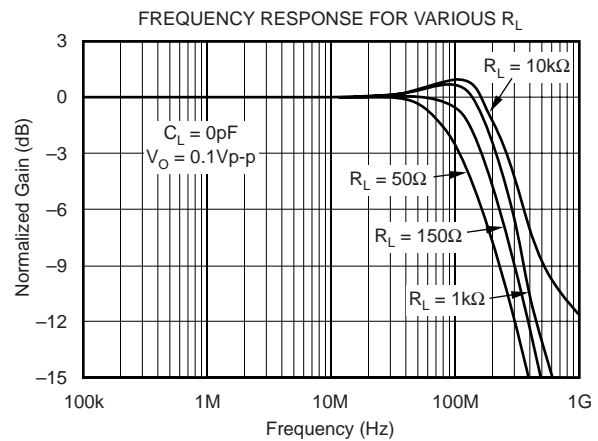
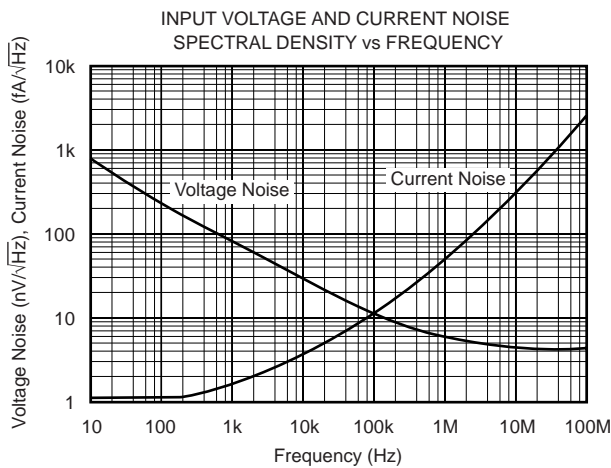
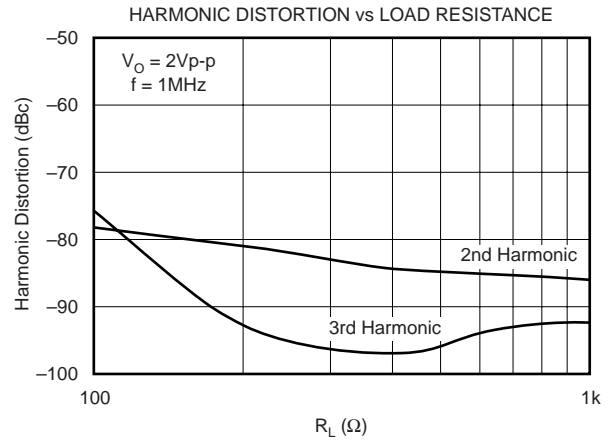
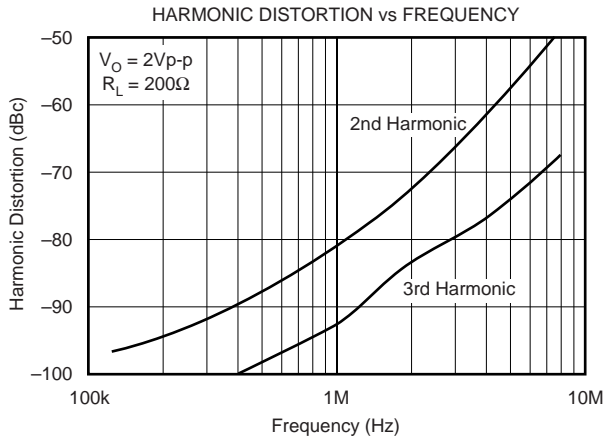
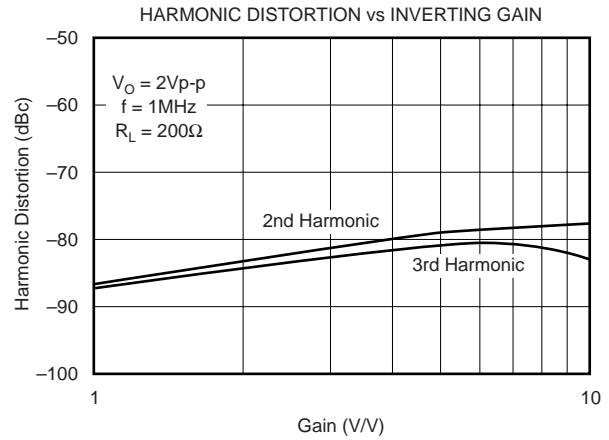
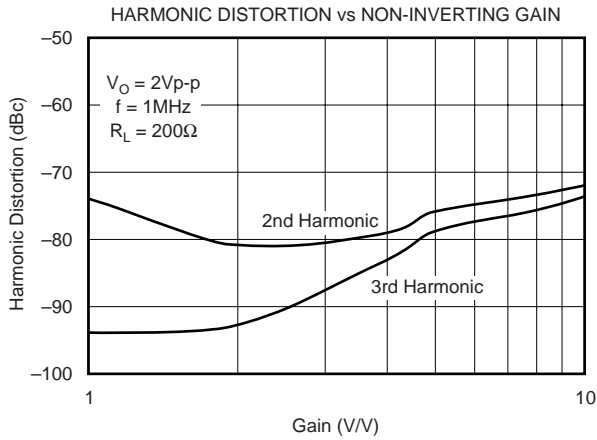

TYPICAL CHARACTERISTICS (Cont.)

At $T_A = +25^\circ\text{C}$ and $V_S = 5\text{V}$, $G = +2$, $R_F = 604\Omega$, $R_L = 150\Omega$ connected to $V_S/2$, unless otherwise noted.

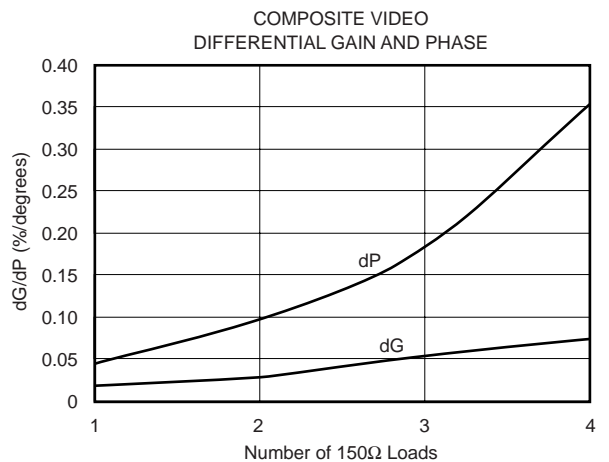
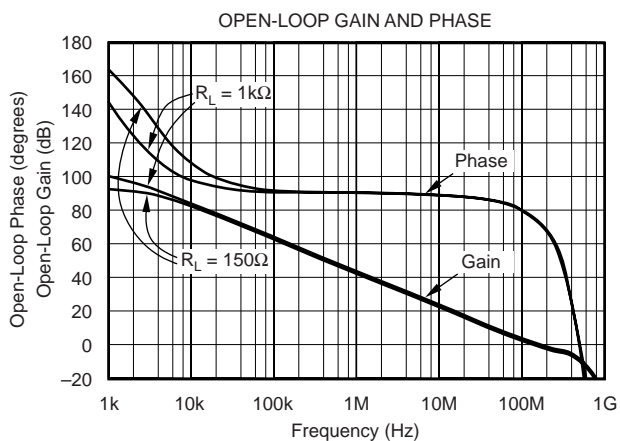
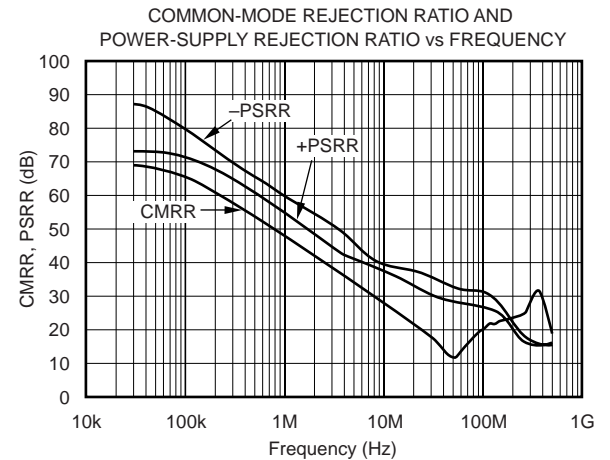
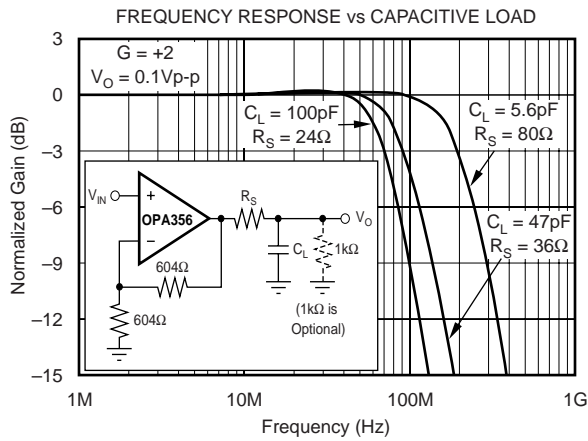
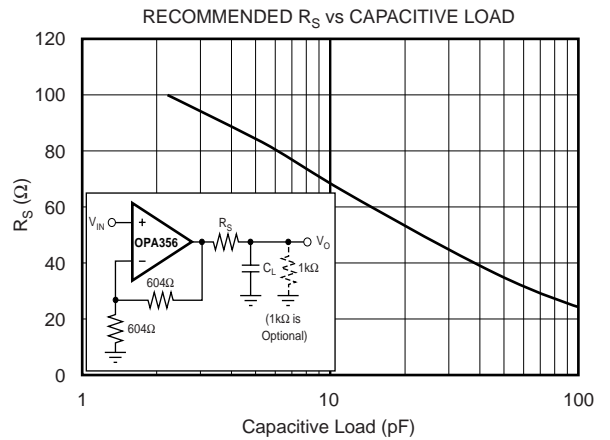
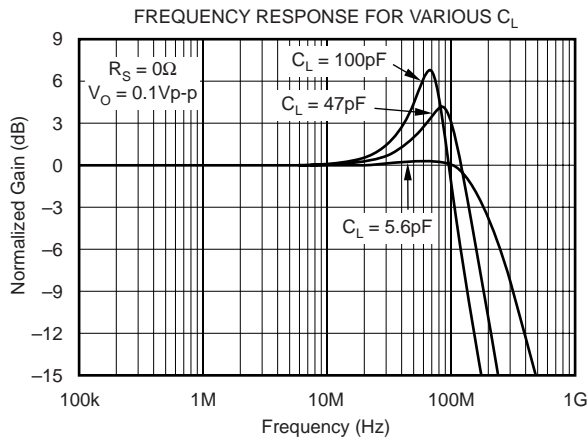

TYPICAL CHARACTERISTICS (Cont.)

At $T_A = +25^\circ\text{C}$ and $V_S = 5\text{V}$, $G = +2$, $R_F = 604\Omega$, $R_L = 150\Omega$ connected to $V_S/2$, unless otherwise noted.

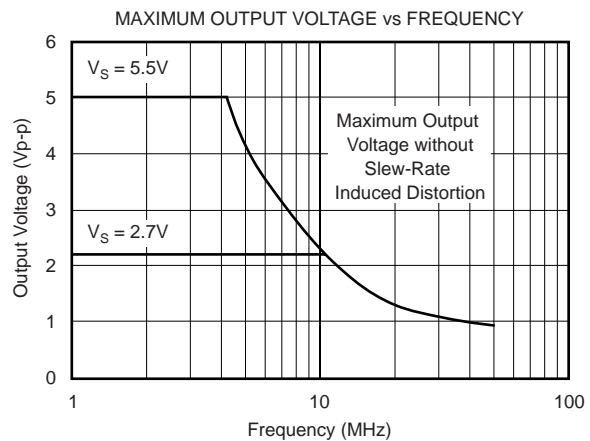
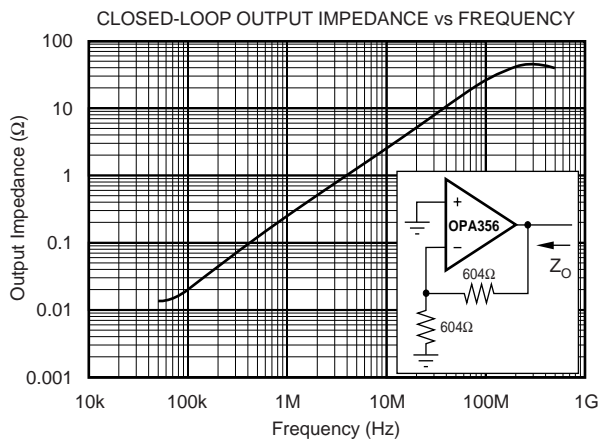
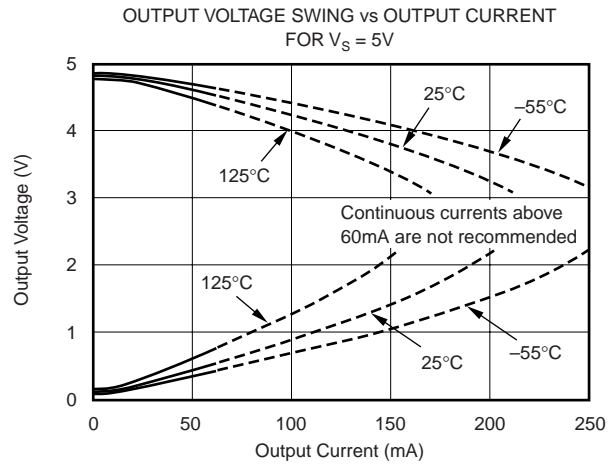
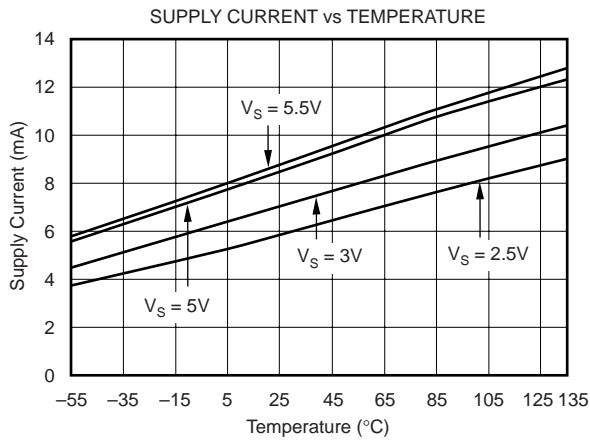
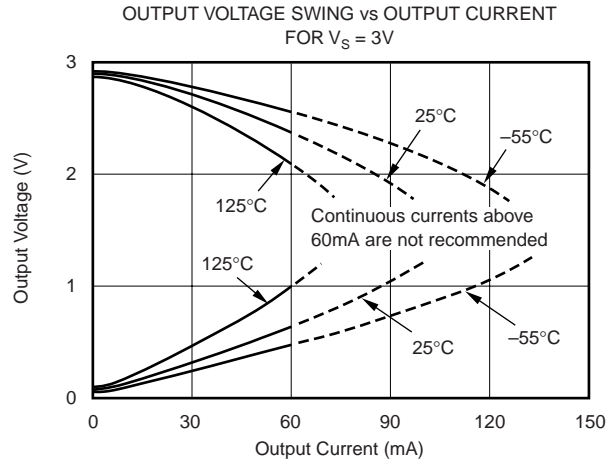
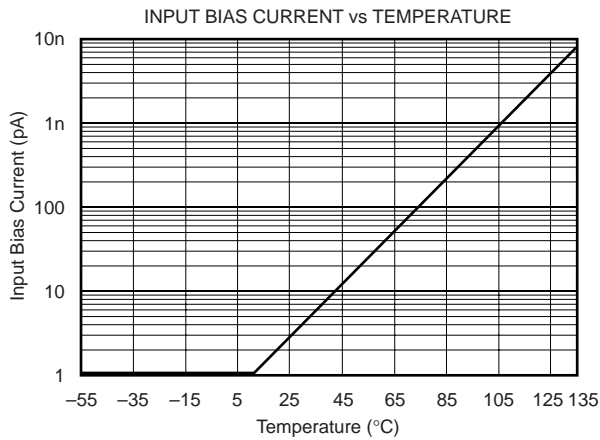

TYPICAL CHARACTERISTICS (Cont.)

At $T_A = +25^\circ\text{C}$ and $V_S = 5\text{V}$, $G = +2$, $R_F = 604\Omega$, $R_L = 150\Omega$ connected to $V_S/2$, unless otherwise noted.

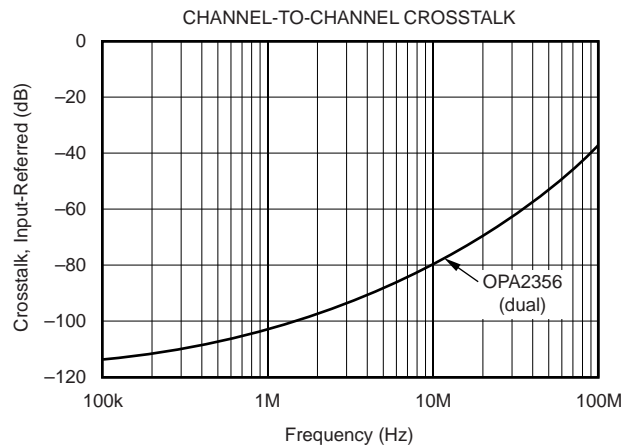
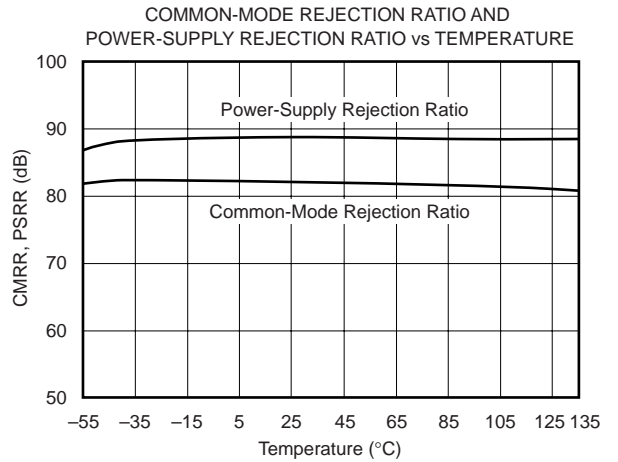
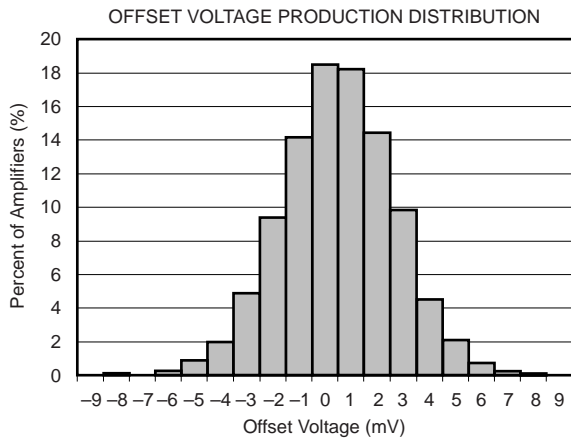
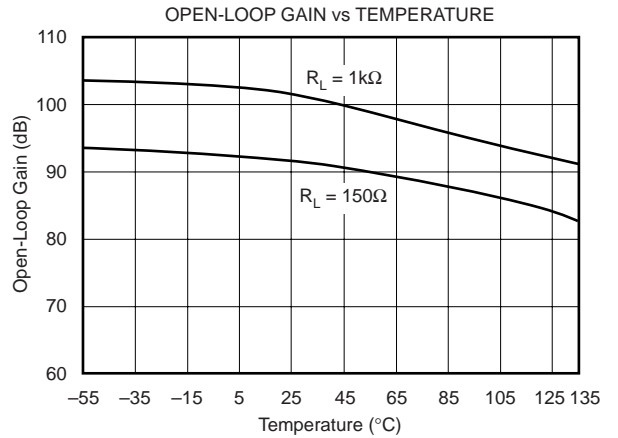
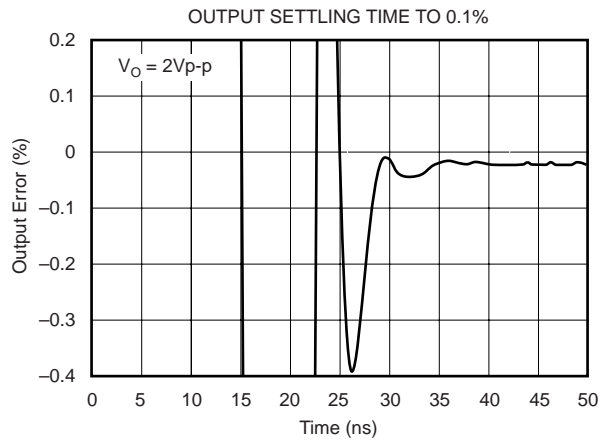

APPLICATIONS INFORMATION

The OPAx356 series is a CMOS, high-speed, voltage feed-back, operational amplifier designed for video and other general-purpose applications. It is available as a single or dual op amp.

The amplifier features a 200MHz gain bandwidth and 360V/ μ s slew rate, but it is unity-gain stable and can be operated as a +1V/V voltage follower.

Its input common-mode voltage range includes ground, allowing the OPAx356 to be used in virtually any single-supply application up to a supply voltage of +5.5V.

PCB LAYOUT

Good high-frequency PC board layout techniques should be employed for the OPAx356. Generous use of ground planes, short direct signal traces, and a suitable bypass capacitor located at the V+ pin will assure clean, stable operation. Large areas of copper also provide a means of dissipating heat that is generated within the amplifier in normal operation.

Sockets are definitely not recommended for use with any high-speed amplifier.

A 10 μ F ceramic bypass capacitor is the minimum recommended value; adding a 1 μ F or larger tantalum capacitor in parallel can be beneficial when driving a low-resistance load. Providing adequate bypass capacitance is essential to achieving very low harmonic and intermodulation distortion.

OPERATING VOLTAGE

The OPAx356 is specified over a power-supply range of +2.7V to +5.5V (± 1.35 to ± 2.75 V). However, the supply voltage may range from +2.5V to +5.5V (± 1.25 V to ± 2.75 V). Supply voltages higher than 7.5V (absolute maximum) can permanently damage the amplifier.

Parameters that vary significantly over supply voltage or temperature are shown in the "Typical Characteristics" section of this data sheet.

OUTPUT DRIVE

The OPAx356 output stage is capable of driving a standard back-terminated 75 Ω video cable. By back-terminating a transmission line, it does not exhibit a capacitive load to its driver. A properly back-terminated 75 Ω cable does not appear as capacitance; it presents only a 150 Ω resistive load to the OPAx356 output.

The output stage can supply high short-circuit current (typically over 200mA). Therefore, an on-chip thermal shutdown circuit is provided to protect the OPAx356 from dangerously high junction temperatures. At 160 $^{\circ}$ C, the protection circuit will shut down the amplifier. Normal operation will resume when the junction temperature cools to below 140 $^{\circ}$ C.

NOTE: It is not recommended to run a continuous DC current in excess of ± 60 mA. Refer to the graph of "Output Voltage Swing vs Output Current", shown in the "Typical Characteristics" section of this data sheet.

INPUT AND ESD PROTECTION

All OPAx356 pins are static protected with internal ESD protection diodes tied to the supplies, as shown in Figure 1.

These diodes will provide overdrive protection if the current is externally limited to 10mA by the source or by a resistor.

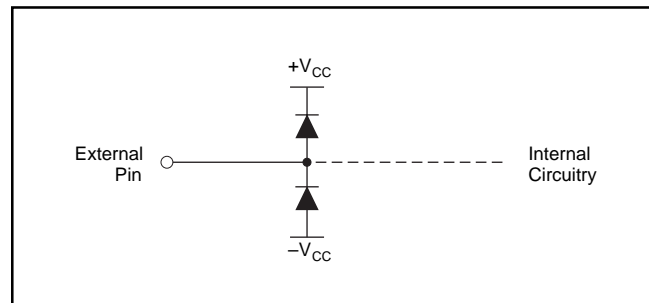
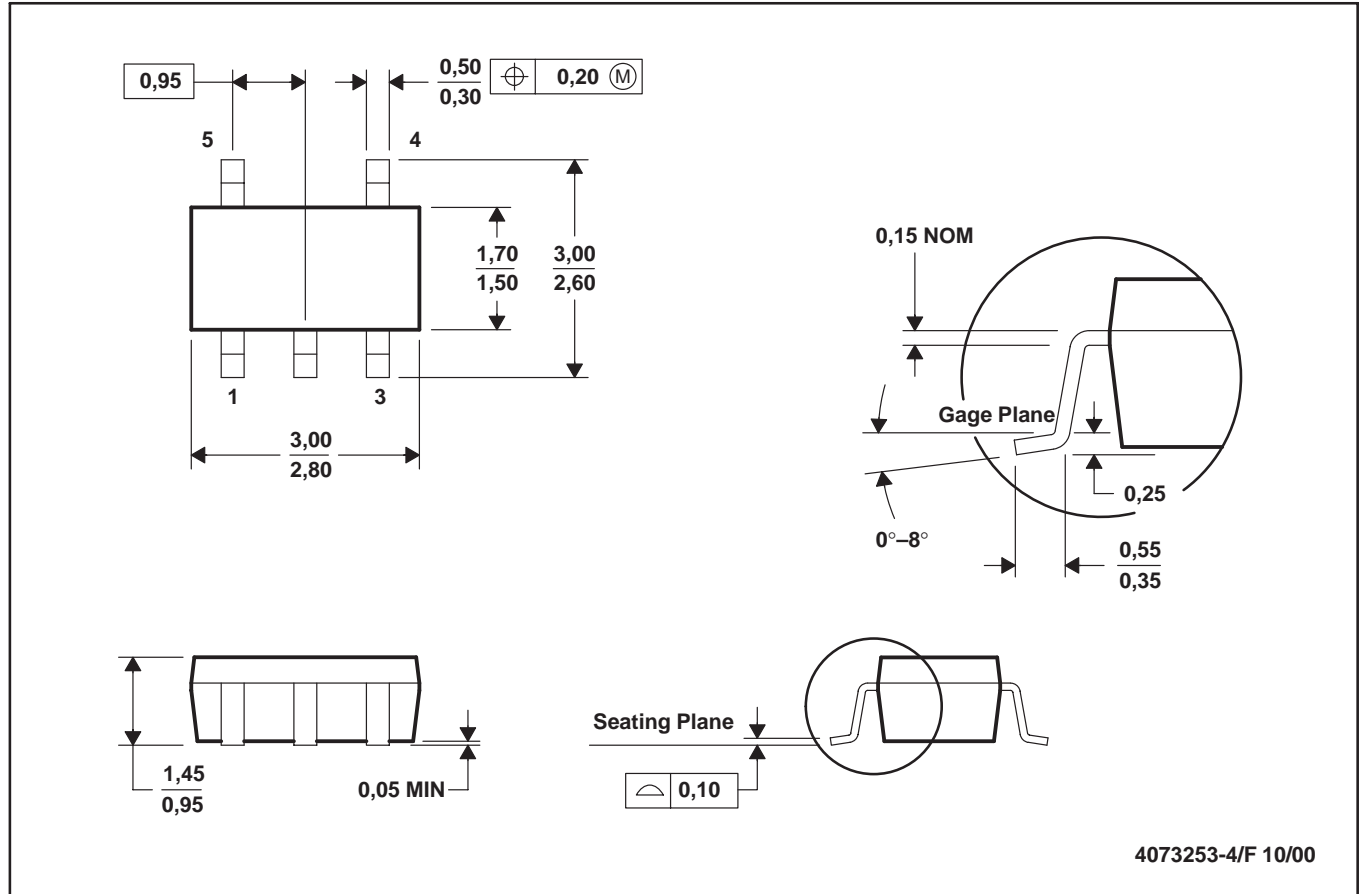

FIGURE 1. Internal ESD Protection.

DBV (R-PDSO-G5)

PLASTIC SMALL-OUTLINE



- NOTES:
- A. All linear dimensions are in millimeters.
 - B. This drawing is subject to change without notice.
 - C. Body dimensions do not include mold flash or protrusion.
 - D. Falls within JEDEC MO-178

DGK (R-PDSO-G8)

PLASTIC SMALL-OUTLINE PACKAGE

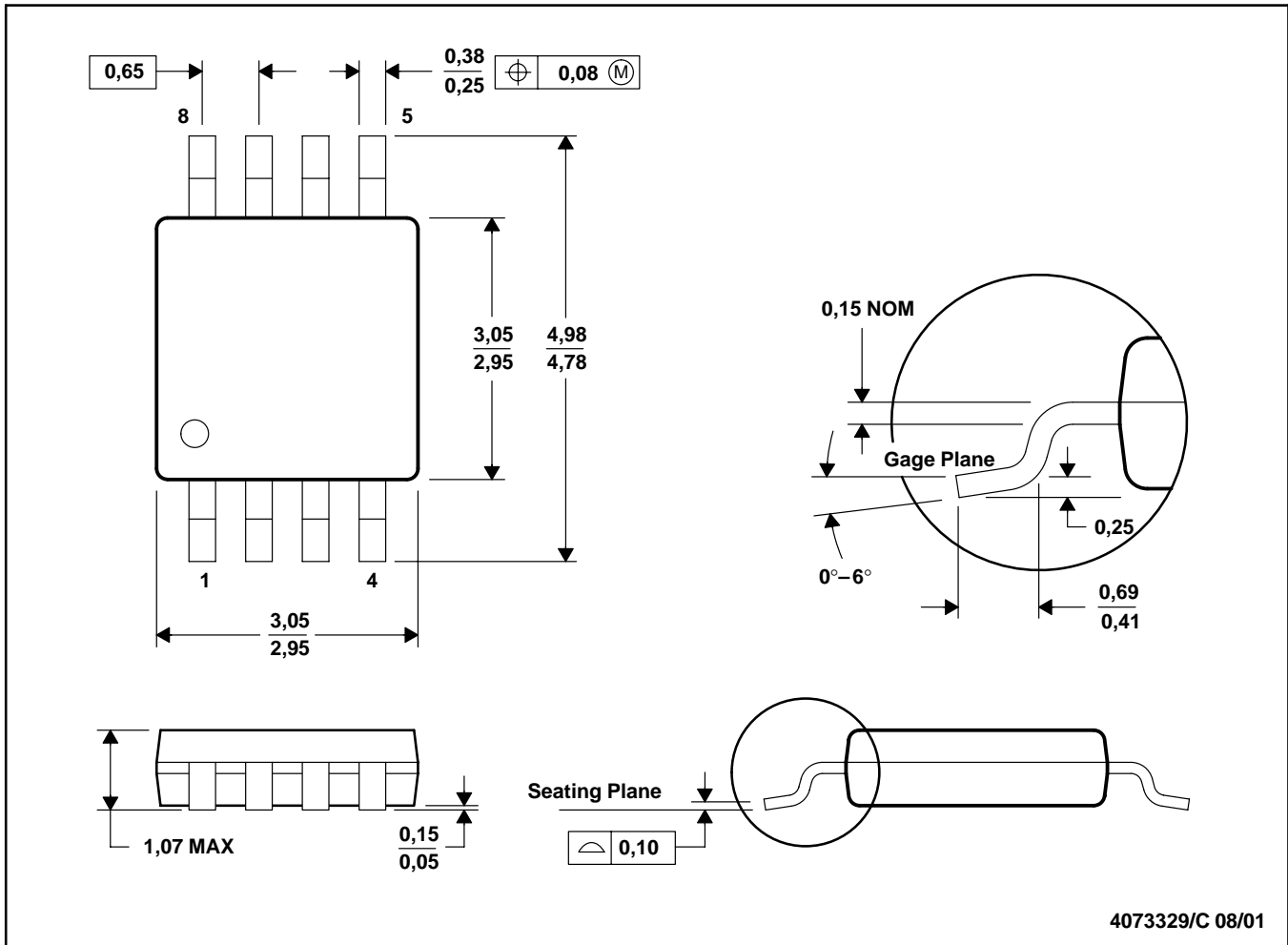

- NOTES:
- A. All linear dimensions are in millimeters.
 - B. This drawing is subject to change without notice.
 - C. Body dimensions do not include mold flash or protrusion.
 - D. Falls within JEDEC MO-187

D (R-PDSO-G**)

PLASTIC SMALL-OUTLINE PACKAGE

8 PINS SHOWN

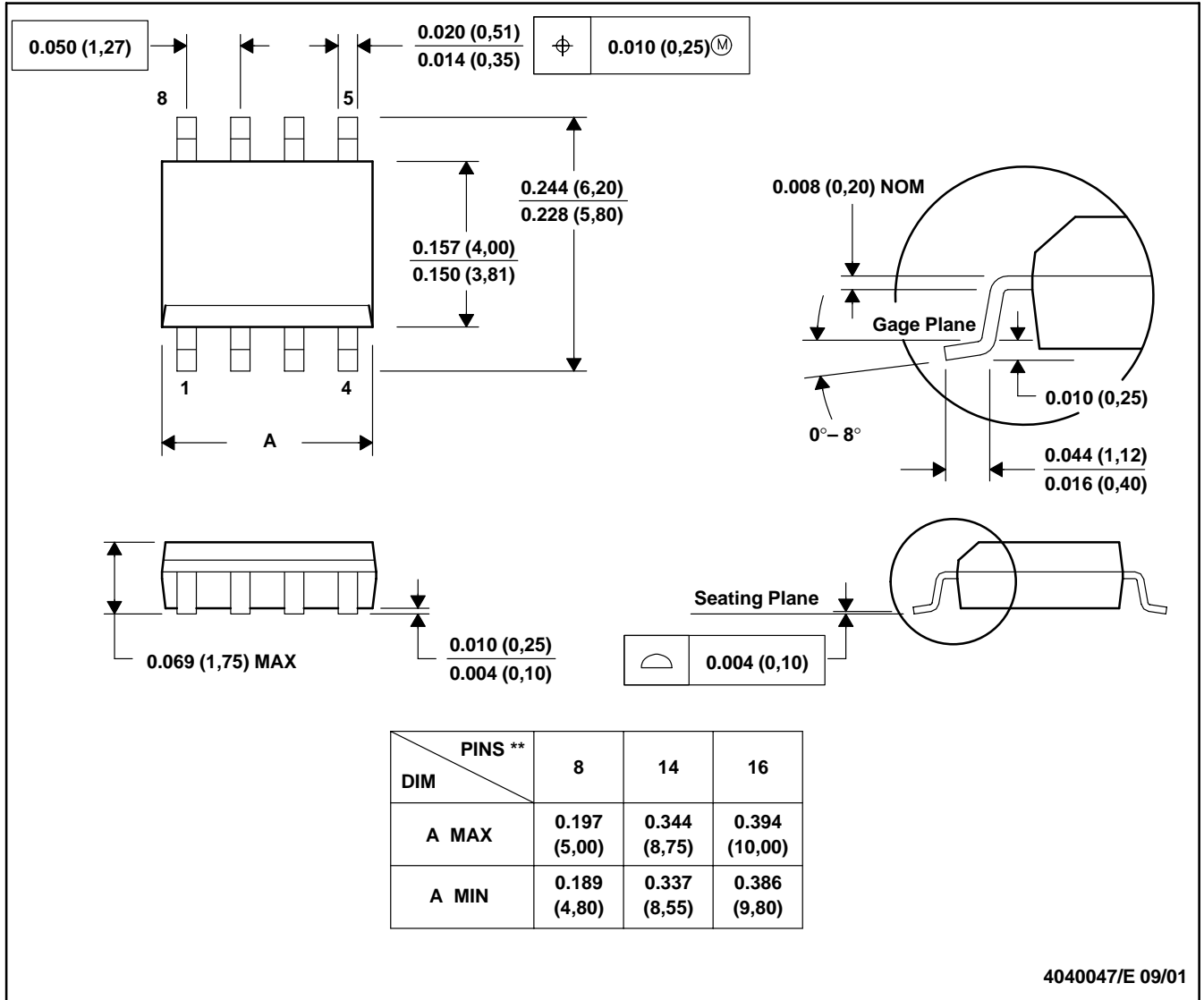

- NOTES: A. All linear dimensions are in inches (millimeters).
 B. This drawing is subject to change without notice.
 C. Body dimensions do not include mold flash or protrusion, not to exceed 0.006 (0,15).
 D. Falls within JEDEC MS-012

PACKAGING INFORMATION

Orderable Device	Status (1)	Package Type	Package Drawing	Pins	Package Qty	Eco Plan (2)	Lead/Ball Finish (6)	MSL Peak Temp (3)	Op Temp (°C)	Device Marking (4/5)	Samples
OPA2356AID	ACTIVE	SOIC	D	8	75	Green (RoHS & no Sb/Br)	NIPDAU	Level-2-260C-1 YEAR	-40 to 125	OPA 2356A	Samples
OPA2356AIDG4	ACTIVE	SOIC	D	8	75	Green (RoHS & no Sb/Br)	NIPDAU	Level-2-260C-1 YEAR	-40 to 125	OPA 2356A	Samples
OPA2356AIDGKR	ACTIVE	VSSOP	DGK	8	2500	Green (RoHS & no Sb/Br)	NIPDAUAG	Level-2-260C-1 YEAR	-40 to 125	AYI	Samples
OPA2356AIDGKT	ACTIVE	VSSOP	DGK	8	250	Green (RoHS & no Sb/Br)	NIPDAUAG	Level-2-260C-1 YEAR	-40 to 125	AYI	Samples
OPA2356AIDGKTG4	ACTIVE	VSSOP	DGK	8	250	Green (RoHS & no Sb/Br)	NIPDAUAG	Level-2-260C-1 YEAR	-40 to 125	AYI	Samples
OPA2356AIDR	ACTIVE	SOIC	D	8	2500	Green (RoHS & no Sb/Br)	NIPDAU	Level-2-260C-1 YEAR	-40 to 125	OPA 2356A	Samples
OPA356AID	ACTIVE	SOIC	D	8	75	Green (RoHS & no Sb/Br)	NIPDAU	Level-2-260C-1 YEAR	-40 to 125	OPA 356A	Samples
OPA356AIDBVR	ACTIVE	SOT-23	DBV	5	3000	Green (RoHS & no Sb/Br)	NIPDAU	Level-2-260C-1 YEAR	-40 to 125	OAAI	Samples
OPA356AIDBVT	ACTIVE	SOT-23	DBV	5	250	Green (RoHS & no Sb/Br)	NIPDAU	Level-2-260C-1 YEAR	-40 to 125	OAAI	Samples
OPA356AIDBVTG4	ACTIVE	SOT-23	DBV	5	250	Green (RoHS & no Sb/Br)	NIPDAU	Level-2-260C-1 YEAR	-40 to 125	OAAI	Samples
OPA356AIDG4	ACTIVE	SOIC	D	8	75	Green (RoHS & no Sb/Br)	NIPDAU	Level-2-260C-1 YEAR	-40 to 125	OPA 356A	Samples
OPA356AIDR	ACTIVE	SOIC	D	8	2500	Green (RoHS & no Sb/Br)	NIPDAU	Level-2-260C-1 YEAR	-40 to 125	OPA 356A	Samples

(1) The marketing status values are defined as follows:

ACTIVE: Product device recommended for new designs.

LIFEBUY: TI has announced that the device will be discontinued, and a lifetime-buy period is in effect.

NRND: Not recommended for new designs. Device is in production to support existing customers, but TI does not recommend using this part in a new design.

PREVIEW: Device has been announced but is not in production. Samples may or may not be available.

OBSELETE: TI has discontinued the production of the device.

(2) **RoHS:** TI defines "RoHS" to mean semiconductor products that are compliant with the current EU RoHS requirements for all 10 RoHS substances, including the requirement that RoHS substance do not exceed 0.1% by weight in homogeneous materials. Where designed to be soldered at high temperatures, "RoHS" products are suitable for use in specified lead-free processes. TI may reference these types of products as "Pb-Free".

RoHS Exempt: TI defines "RoHS Exempt" to mean products that contain lead but are compliant with EU RoHS pursuant to a specific EU RoHS exemption.

Green: TI defines "Green" to mean the content of Chlorine (Cl) and Bromine (Br) based flame retardants meet JS709B low halogen requirements of ≤ 1000 ppm threshold. Antimony trioxide based flame retardants must also meet the ≤ 1000 ppm threshold requirement.

(3) MSL, Peak Temp. - The Moisture Sensitivity Level rating according to the JEDEC industry standard classifications, and peak solder temperature.

(4) There may be additional marking, which relates to the logo, the lot trace code information, or the environmental category on the device.

(5) Multiple Device Markings will be inside parentheses. Only one Device Marking contained in parentheses and separated by a "~" will appear on a device. If a line is indented then it is a continuation of the previous line and the two combined represent the entire Device Marking for that device.

(6) Lead/Ball Finish - Orderable Devices may have multiple material finish options. Finish options are separated by a vertical ruled line. Lead/Ball Finish values may wrap to two lines if the finish value exceeds the maximum column width.

Important Information and Disclaimer: The information provided on this page represents TI's knowledge and belief as of the date that it is provided. TI bases its knowledge and belief on information provided by third parties, and makes no representation or warranty as to the accuracy of such information. Efforts are underway to better integrate information from third parties. TI has taken and continues to take reasonable steps to provide representative and accurate information but may not have conducted destructive testing or chemical analysis on incoming materials and chemicals. TI and TI suppliers consider certain information to be proprietary, and thus CAS numbers and other limited information may not be available for release.

In no event shall TI's liability arising out of such information exceed the total purchase price of the TI part(s) at issue in this document sold by TI to Customer on an annual basis.

OTHER QUALIFIED VERSIONS OF OPA2356, OPA356 :

- Automotive: [OPA356-Q1](#)
- Enhanced Product: [OPA2356-EP](#)

NOTE: Qualified Version Definitions:

- Automotive - Q100 devices qualified for high-reliability automotive applications targeting zero defects
- Enhanced Product - Supports Defense, Aerospace and Medical Applications

TAPE AND REEL INFORMATION

QUADRANT ASSIGNMENTS FOR PIN 1 ORIENTATION IN TAPE

*All dimensions are nominal

Device	Package Type	Package Drawing	Pins	SPQ	Reel Diameter (mm)	Reel Width W1 (mm)	A0 (mm)	B0 (mm)	K0 (mm)	P1 (mm)	W (mm)	Pin1 Quadrant
OPA2356AIDGKR	VSSOP	DGK	8	2500	330.0	12.4	5.3	3.4	1.4	8.0	12.0	Q1
OPA2356AIDGKT	VSSOP	DGK	8	250	180.0	12.4	5.3	3.4	1.4	8.0	12.0	Q1
OPA2356AIDR	SOIC	D	8	2500	330.0	12.4	6.4	5.2	2.1	8.0	12.0	Q1
OPA356AIDBVR	SOT-23	DBV	5	3000	178.0	8.4	3.3	3.2	1.4	4.0	8.0	Q3
OPA356AIDBVT	SOT-23	DBV	5	250	178.0	8.4	3.3	3.2	1.4	4.0	8.0	Q3
OPA356AIDR	SOIC	D	8	2500	330.0	12.4	6.4	5.2	2.1	8.0	12.0	Q1

TAPE AND REEL BOX DIMENSIONS

*All dimensions are nominal

Device	Package Type	Package Drawing	Pins	SPQ	Length (mm)	Width (mm)	Height (mm)
OPA2356AIDGKR	VSSOP	DGK	8	2500	367.0	367.0	35.0
OPA2356AIDGKT	VSSOP	DGK	8	250	210.0	185.0	35.0
OPA2356AIDR	SOIC	D	8	2500	367.0	367.0	35.0
OPA356AIDBVR	SOT-23	DBV	5	3000	445.0	220.0	345.0
OPA356AIDBVT	SOT-23	DBV	5	250	445.0	220.0	345.0
OPA356AIDR	SOIC	D	8	2500	367.0	367.0	35.0

IMPORTANT NOTICE AND DISCLAIMER

TI PROVIDES TECHNICAL AND RELIABILITY DATA (INCLUDING DATASHEETS), DESIGN RESOURCES (INCLUDING REFERENCE DESIGNS), APPLICATION OR OTHER DESIGN ADVICE, WEB TOOLS, SAFETY INFORMATION, AND OTHER RESOURCES "AS IS" AND WITH ALL FAULTS, AND DISCLAIMS ALL WARRANTIES, EXPRESS AND IMPLIED, INCLUDING WITHOUT LIMITATION ANY IMPLIED WARRANTIES OF MERCHANTABILITY, FITNESS FOR A PARTICULAR PURPOSE OR NON-INFRINGEMENT OF THIRD PARTY INTELLECTUAL PROPERTY RIGHTS.

These resources are intended for skilled developers designing with TI products. You are solely responsible for (1) selecting the appropriate TI products for your application, (2) designing, validating and testing your application, and (3) ensuring your application meets applicable standards, and any other safety, security, or other requirements. These resources are subject to change without notice. TI grants you permission to use these resources only for development of an application that uses the TI products described in the resource. Other reproduction and display of these resources is prohibited. No license is granted to any other TI intellectual property right or to any third party intellectual property right. TI disclaims responsibility for, and you will fully indemnify TI and its representatives against, any claims, damages, costs, losses, and liabilities arising out of your use of these resources.

TI's products are provided subject to TI's Terms of Sale (www.ti.com/legal/termsofsale.html) or other applicable terms available either on ti.com or provided in conjunction with such TI products. TI's provision of these resources does not expand or otherwise alter TI's applicable warranties or warranty disclaimers for TI products.

Mailing Address: Texas Instruments, Post Office Box 655303, Dallas, Texas 75265
Copyright © 2020, Texas Instruments Incorporated