

EVALUATION KIT
AVAILABLE

0 to 16V, Hot-Swap Controller with 10-Bit Current, Voltage Monitor, and 4 LED Drivers

MAX5978

General Description

The MAX5978 hot-swap controller provides complete protection for systems with a supply voltage from 0 to 16V. The device includes four programmable LED outputs.

The IC provides two programmable levels of overcurrent circuit-breaker protection: a fast-trip threshold for a fast turn-off, and a lower slow-trip threshold for a delayed turn-off. The maximum overcurrent circuit-breaker threshold range is set with a trilevel logic input (IRNG), or by programming through the I²C interface.

The IC is an advanced hot-swap controller that monitors voltage and current with an internal 10-bit ADC, which is continuously multiplexed to convert the output voltage and current at 10ksps. Each 10-bit sample is stored in an internal circular buffer so that 50 past samples of each signal can be read back through the I²C interface at any time or after a fault condition.

The device includes five user-programmable digital comparators to implement overcurrent warning and two levels of overvoltage/undervoltage detection. When measured values violate the programmable limits, an external ALERT output is asserted. In addition to the ALERT signal, the IC can be programmed to deassert the power-good signal and/or turn off the external MOSFET.

The IC features four I/Os that can be independently configured as general-purpose input/outputs (GPIOs) or as open-drain LED drivers with programmable blinking. These four I/Os can be configured for any mix of LED driver or GPIO function.

The device is available in a 32-pin thin QFN-EP package and operates over the -40°C to +85°C extended temperature range.

Ordering Information

PART	TEMP RANGE	PIN-PACKAGE
MAX5978ETJ+	-40°C to +85°C	32 TQFN-EP*

+Denotes a lead(Pb)-free/RoHS-compliant package.

*EP = Exposed pad.

Features

- ◆ Hot-Swap Controller Operates from 0 to 16V
- ◆ 10-Bit ADC Monitors Load Voltage and Current
- ◆ Circular Buffers Store 5ms of Current and Voltage Measurements
- ◆ Internal Charge Pump Generates n-Channel MOSFET Gate Drive
- ◆ Internal 500mA Gate Pulldown Current for Fast Shutdown
- ◆ VariableSpeed/Bilevel™ Circuit-Breaker Protection
- ◆ Precision-Voltage Enable Input
- ◆ Alert Output Indicates Fault and Warning Conditions
- ◆ Open-Drain Power-Good Output with Programmable Polarity
- ◆ Open-Drain Fault Output
- ◆ Four Open-Drain General-Purpose Outputs Sink 25mA to Directly Drive LEDs
- ◆ Programmable LED Flashing Function
- ◆ Latched-Off Fault Management
- ◆ 400kHz I²C Interface
- ◆ Small, 5mm x 5mm, 32-Pin TQFN-EP Package

Applications

Blade Servers
 DC Power Metering
 Disk Drives/DASD/Storage Systems
 Soft-Switch for ASICs, FPGAs, and Microcontrollers
 Network Switches/Routers

VariableSpeed/Bilevel is a trademark of Maxim Integrated Products, Inc.



0 to 16V, Hot-Swap Controller with 10-Bit Current, Voltage Monitor, and 4 LED Drivers

ABSOLUTE MAXIMUM RATINGS

IN, SENSE, MON, GATE to AGND	-0.3V to +30V
LED_ to AGND	-0.3V to +16V
PG, ON, ALERT, FAULT, SDA, SCL to AGND	-0.3V to +6V
REG, DREG, IRNG, MODE, PROT, A_ to AGND ...	-0.3V to +4V
REG to DREG	-0.3V to +0.3V
HWEN, POL to AGND	-0.3V to (VREG + 0.3V)
GATE to MON	-0.3V to +6V
GND, DGND to AGND	-0.3V to +0.3V
SDA, ALERT Current	-20mA to +50mA
LED_ Current	-20mA to +100mA
GATE, MON, GND Current	750mA

All Other Pins Input/Output Current	20mA
Continuous Power Dissipation (T _A = +70°C)*	
32-Pin TQFN (derate 34.5mW/°C above +70°C).....	2759mW*
Junction-to-Ambient Thermal Resistance (θ _{JA}) (Note 1).....	+29°C/W
Operating Temperature Range	-40°C to +85°C
Junction Temperature	+150°C
Storage Temperature Range	-65°C to +150°C
Lead Temperature (soldering, 10s)	+300°C
Soldering Temperature (reflow)	+260°C

* As per JEDEC51 Standard (Multilayer Board).

Note 1: Package thermal resistances were obtained using the method described in JEDEC specification JESD51-7, using a four-layer board. For detailed information on package thermal considerations, refer to www.maxim-ic.com/thermal-tutorial.

Stresses beyond those listed under "Absolute Maximum Ratings" may cause permanent damage to the device. These are stress ratings only, and functional operation of the device at these or any other conditions beyond those indicated in the operational sections of the specifications is not implied. Exposure to absolute maximum rating conditions for extended periods may affect device reliability.

ELECTRICAL CHARACTERISTICS

(V_{IN} = 2.7V to 16V, T_A = -40°C to +85°C, unless otherwise noted. Typical values are at V_{IN} = 3.3V and T_A = +25°C.) (Note 2)

PARAMETER	SYMBOL	CONDITIONS	MIN	TYP	MAX	UNITS
Supply Input Voltage Range	V _{IN}		2.7		16	V
Hot-Swap Voltage Range			0		16	V
Supply Current	I _{IN}			2.5	4	mA
Internal LDO Output Voltage	REG	I _{REG} = 0 to 5mA, V _{IN} = 2.7V to 16V	2.49	2.53	2.6	V
Undervoltage Lockout	UVLO	V _{IN} rising			2.6	V
Undervoltage-Lockout Hysteresis	UVLOHYS			100		mV
CURRENT-MONITORING FUNCTION						
MON, SENSE Input Voltage Range			0		16	V
SENSE Input Current		V _{SENSE} , V _{MON} = 16V		32	75	μA
MON Input Current		V _{SENSE} , V _{MON} = 16V		180	280	μA
Current Measurement LSB Voltage		25mV range		24.34		μV
		50mV range		48.39		
		100mV range		96.77		
Current Measurement Error (25mV Range)	V _{MON} = 0V	V _{SENSE} - V _{MON} = 5mV	-6.57		+6.22	%FS
		V _{SENSE} - V _{MON} = 20mV	-6.71		+6.82	
	V _{MON} = 2.5V to 16V	V _{SENSE} - V _{MON} = 5mV	-9.71		+8.92	
		V _{SENSE} - V _{MON} = 20mV	-10.24		+9.36	
Current Measurement Error (50mV Range)	V _{MON} = 0V	V _{SENSE} - V _{MON} = 10mV	-4.24		+3.78	%FS
		V _{SENSE} - V _{MON} = 40mV	-4.53		+5.36	
	V _{MON} = 2.5V to 16V	V _{SENSE} - V _{MON} = 10mV	-4.50		+4.00	
		V _{SENSE} - V _{MON} = 40mV	-4.20		+4.50	

0 to 16V, Hot-Swap Controller with 10-Bit Current, Voltage Monitor, and 4 LED Drivers

MAX5978

ELECTRICAL CHARACTERISTICS (continued)

($V_{IN} = 2.7V$ to $16V$, $T_A = -40^{\circ}C$ to $+85^{\circ}C$, unless otherwise noted. Typical values are at $V_{IN} = 3.3V$ and $T_A = +25^{\circ}C$.) (Note 2)

PARAMETER	SYMBOL	CONDITIONS	MIN	TYP	MAX	UNITS
Current Measurement Error (100mV Range)	$V_{MON} = 0V$	$V_{SENSE} - V_{MON} = 20mV$	-2.70		+2.43	%FS
		$V_{SENSE} - V_{MON} = 80mV$	-3.63		+4.56	
	$V_{MON} = 2.5V$ to $16V$	$V_{SENSE} - V_{MON} = 20mV$	-3.14		+3.19	
		$V_{SENSE} - V_{MON} = 80mV$	-3.80		+3.93	
Fast Current-Limit Threshold Error (25mV Range)	$V_{MON} = 0V$	Circuit breaker, DAC = 102	-2.106		+0.888	mV
		Circuit breaker, DAC = 255	-2.986		+0.641	
	$V_{MON} = 2.5V$ to $16V$	Circuit breaker, DAC = 102	-3.000		+1.000	
		Circuit breaker, DAC = 255	-3.500		+1.500	
Fast Current-Limit Threshold Error (50mV Range)	$V_{MON} = 0V$	Circuit breaker, DAC = 102	-3.1188		+0.926	mV
		Circuit breaker, DAC = 255	-4.873		+0.3421	
	$V_{MON} = 2.5V$ to $16V$	Circuit breaker, DAC = 102	-3.2668		+0.9228	
		Circuit breaker, DAC = 255	-4.7		+1.0212	
Fast Current-Limit Threshold Error (100mV Range)	$V_{MON} = 0V$	Circuit breaker, DAC = 102	-4.7987		+1.1812	mV
		Circuit breaker, DAC = 255	-8.9236		+0.202	
	$V_{MON} = 2.5V$ to $16V$	Circuit breaker, DAC = 102	-4.9991		+0.6374	
		Circuit breaker, DAC = 255	-8.262		+1	
Slow Current-Limit Threshold Error (25mV Range)	$V_{MON} = 0V$	Circuit breaker, DAC = 102	-1.7965		+1.5496	mV
		Circuit breaker, DAC = 255	-1.86		+1.5916	
	$V_{MON} = 2.5V$ to $16V$	Circuit breaker, DAC = 102	-2.149		+1.9868	
		Circuit breaker, DAC = 255	-2.2285		+1.9982	
Slow Current-Limit Threshold Error (50mV Range)	$V_{MON} = 0V$	Circuit breaker, DAC = 102	-2.3992		+1.8723	mV
		Circuit breaker, DAC = 255	-2.5146		+2.1711	
	$V_{MON} = 2.5V$ to $16V$	Circuit breaker, DAC = 102	-2.4716		+2.181	
		Circuit breaker, DAC = 255	-2.7421		+2.1152	
Slow Current-Limit Threshold Error (100mV Range)	$V_{MON} = 0V$	Circuit breaker, DAC = 102	-3.3412		+2.989	mV
		Circuit breaker, DAC = 255	-3.8762		+3.6789	
	$V_{MON} = 2.5V$ to $16V$	Circuit breaker, DAC = 102	-3.2084		+2.7798	
		Circuit breaker, DAC = 255	-3.8424		+2.6483	
Fast Circuit-Breaker Response Time	t_{FCB}	Overdrive = 10% of current-sense range		2		μs
Slow Current-Limit Response Time	t_{SCB}	Overdrive = 4% of current-sense range		2.4		ms
		Overdrive = 8% of current-sense range		1.2		
		Overdrive = 16% of current-sense range		0.8		
THREE-STATE INPUTS						
A1, A0, IRNG, MODE, PROT Low Current	I_{IN_LOW}	Input voltage = 0.4V	-40			μA
A1, A0, IRNG, MODE, PROT High Current	I_{IN_HIGH}	Input voltage = $V_{REG} - 0.2V$			40	μA
A1, A0, IRNG, MODE, PROT Open Current	I_{FLOAT}	Maximum source/sink current for open state	-4		+4	μA
A1, A0, IRNG, MODE, PROT Low Voltage		Relative to AGND			0.4	V

0 to 16V, Hot-Swap Controller with 10-Bit Current, Voltage Monitor, and 4 LED Drivers

ELECTRICAL CHARACTERISTICS (continued)

($V_{IN} = 2.7V$ to $16V$, $T_A = -40^{\circ}C$ to $+85^{\circ}C$, unless otherwise noted. Typical values are at $V_{IN} = 3.3V$ and $T_A = +25^{\circ}C$.) (Note 2)

PARAMETER	SYMBOL	CONDITIONS	MIN	TYP	MAX	UNITS
A1, A0, IRNG, MODE, PROT High Voltage		Relative to V_{REG}	-0.24			V
TWO-STATE INPUTS						
HWEN, POL Input Logic Low Voltage					0.4	V
HWEN, POL Input Logic High Voltage			$V_{REG} - 0.4$			V
HWEN, POL Input Current			-1		+1	μA
ON Input Voltage	V_{ON}		0.582	0.592	0.602	V
ON Input Hysteresis	V_{ONHYS}			4		%
ON Input Current			-100		+100	nA
TIMING						
MON-to-PG Delay		Register configurable (see Tables 30a and 30b)		50		ms
				100		
				200		
				400		
CHARGE PUMP (GATE)						
Charge-Pump Output Voltage		Relative to V_{MON} , $I_{GATE} = 0V$	4.5	5.3	5.5	V
Charge-Pump Output Source Current			4	5	6	μA
GATE Discharge Current		$V_{GATE} - V_{MON} = 2V$		500		mA
OUTPUT (FAULT, PG, ALERT)						
Output-Voltage Low		$I_{SINK} = 3.2mA$			0.2	V
Output Leakage Current					1	μA
LED INPUT/OUTPUT						
LED_ Input Threshold Low Level	V_{IL}				0.4	V
LED_ Input Threshold High Level	V_{IH}		1.4			V
LED_ Output Low	V_{OH}	$I_{LED_} = 25mA$			0.7	V
LED_ Input Leakage Current (Open Drain)	I_{GPIO_IX}	$V_{LED_} = 16V$	-1		+1	μA
LED_ Weak Pullup Current	I_{PU_WEAK}	$V_{LED_} = V_{IN} - 0.65V$	2			μA
ADC PERFORMANCE						
Resolution				10		Bits
Maximum Integral Nonlinearity	INL			1		LSB
ADC Total Monitoring Cycle Time			95	100	110	μs

0 to 16V, Hot-Swap Controller with 10-Bit Current, Voltage Monitor, and 4 LED Drivers

MAX5978

ELECTRICAL CHARACTERISTICS (continued)

($V_{IN} = 2.7V$ to $16V$, $T_A = -40^{\circ}C$ to $+85^{\circ}C$, unless otherwise noted. Typical values are at $V_{IN} = 3.3V$ and $T_A = +25^{\circ}C$.) (Note 2)

PARAMETER	SYMBOL	CONDITIONS	MIN	TYP	MAX	UNITS
MON LSB Voltage		16V range	15.23	15.49	15.69	mV
		8V range	7.655	7.743	7.811	
		4V range	3.811	3.875	3.933	
		2V range	1.899	1.934	1.966	
MON Code 000H to 001H Transition Voltage		16V range	10	25	41	mV
		8V range	4.7	12	21	
		4V range	2	6	12	
		2V range	0.5	3	5.5	
I²C INTERFACE						
Serial-Clock Frequency	f _{SCL}				400	kHz
Bus Free Time Between STOP and START Conditions	t _{BUF}		1.3			μs
START Condition Setup Time	t _{SU:STA}		0.6			μs
START Condition Hold Time	t _{HD:STA}		0.6			μs
STOP Condition Setup Time	t _{SU:STO}		0.6			μs
Clock High Period	t _{HIGH}		0.6			μs
Clock Low Period	t _{LOW}		1.3			μs
Data Setup Time	t _{SU:DAT}		100			ns
Data Hold Time	t _{HD:DAT}	Transmit	100			ns
		Receive	300		900	
Output Fall Time	t _{OF}	C _{BUS} = 10pF to 400pF			250	ns
Pulse Width of Spike Suppressed	t _{SP}			50		ns
SDA, SCL Input High Voltage	V _{IH}		1.8			V
SDA, SCL Input Low Voltage	V _{IL}				0.8	V
SDA, SCL Input Hysteresis	V _{HYST}			0.22		V
SDA, SCL Input Current			-1		+1	μA
SDA, SCL Input Capacitance				15		pF
SDA Output Voltage	V _{OL}	I _{SINK} = 4mA			0.4	V

Note 2: All devices 100% production tested at $T_A = +25^{\circ}C$. Limits over the temperature range are guaranteed by design.

0 to 16V, Hot-Swap Controller with 10-Bit Current, Voltage Monitor, and 4 LED Drivers

Typical Operating Characteristics

($V_{IN} = 3.3V$, $T_A = +25^\circ C$, unless otherwise noted.)

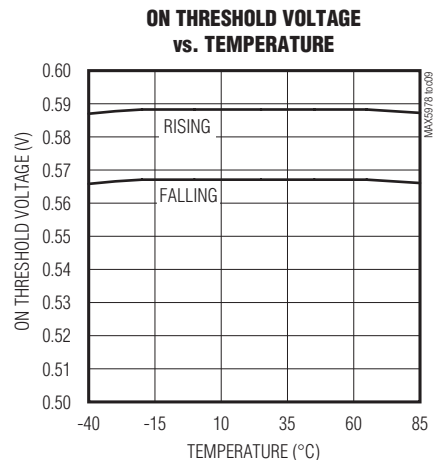
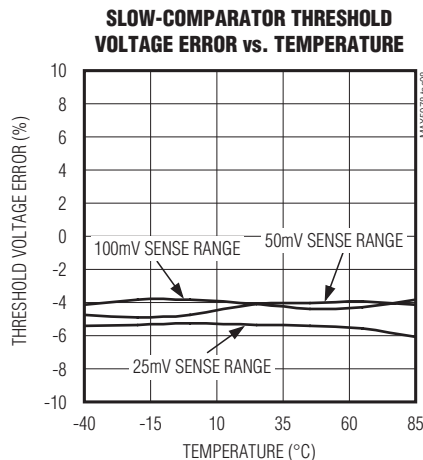
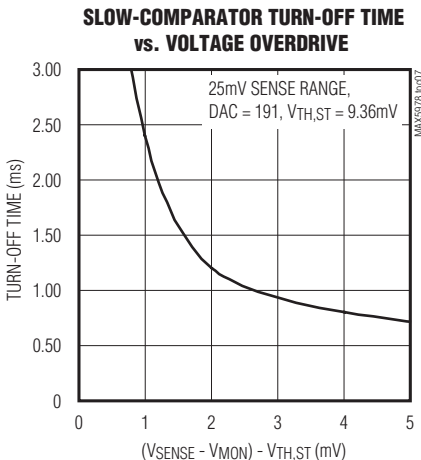
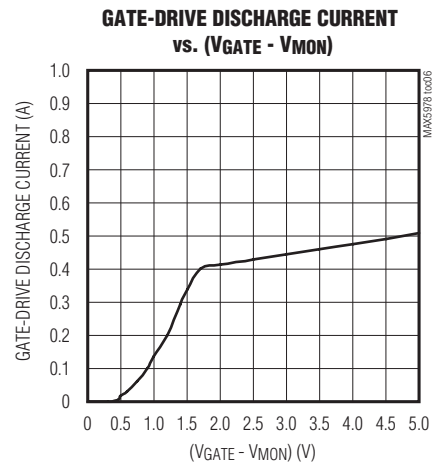
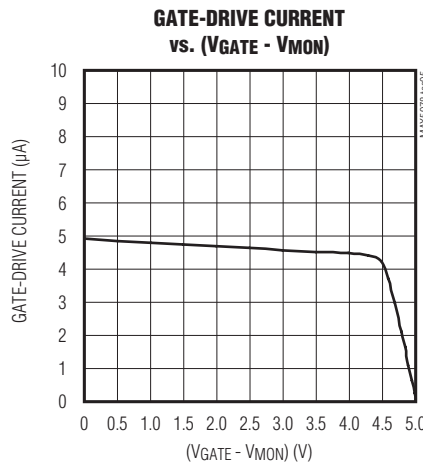
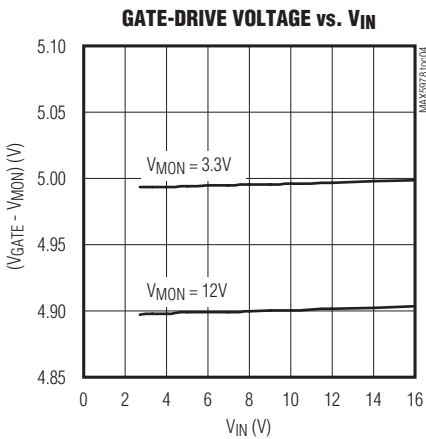
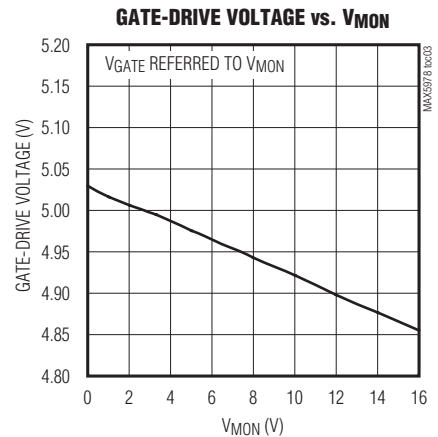
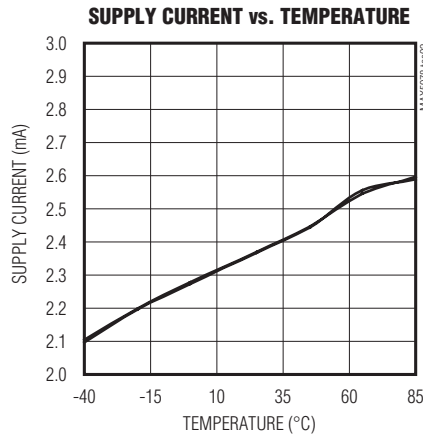
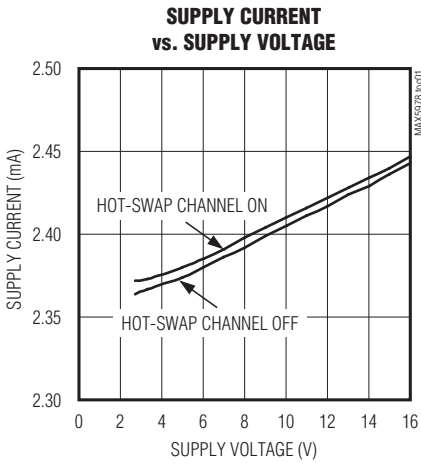

0 to 16V, Hot-Swap Controller with 10-Bit Current, Voltage Monitor, and 4 LED Drivers

Typical Operating Characteristics (continued)

($V_{IN} = 3.3V$, $T_A = +25^\circ C$, unless otherwise noted.)

MAX5978

STARTUP WAVEFORM

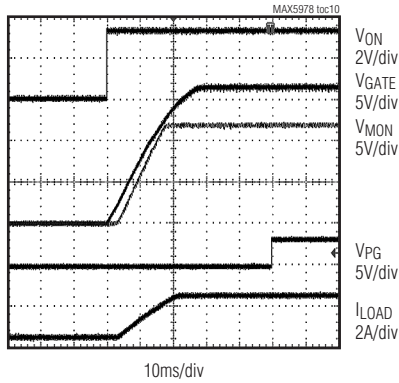

TURN-OFF WAVEFORM (SLOW-COMPARATOR FAULT)

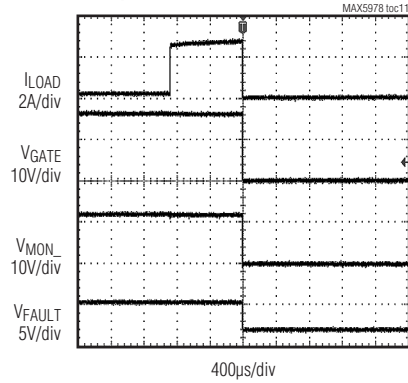

TURN-OFF WAVEFORM (FAST-COMPARATOR FAULT/SHORT-CIRCUIT RESPONSE)

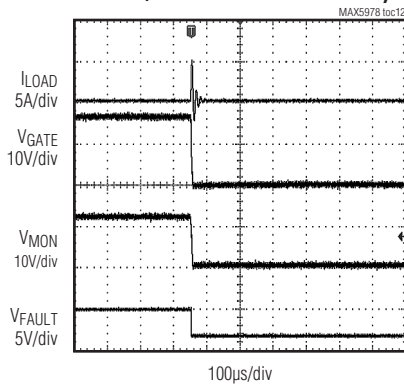

VOLTAGE BUFFER vs. TIME

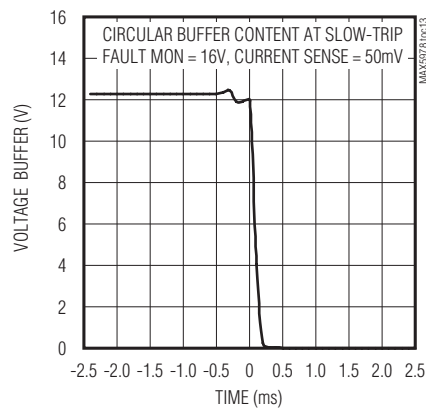

SLOW-COMPARATOR FAULT EVENT

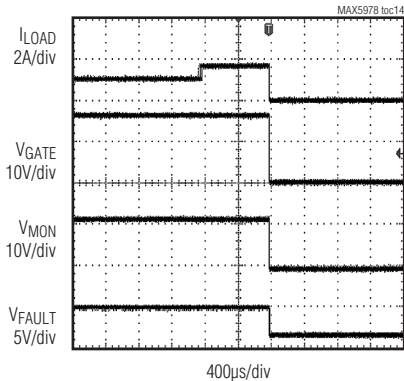

VOLTAGE ADC ACCURACY vs. MON VOLTAGE

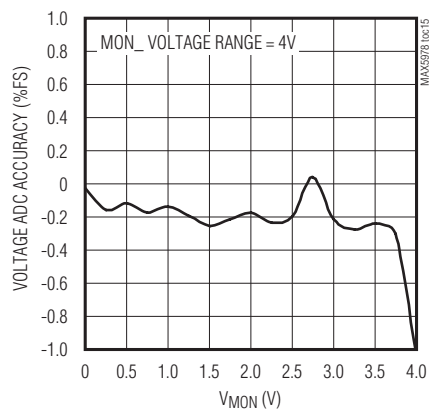

0 to 16V, Hot-Swap Controller with 10-Bit Current, Voltage Monitor, and 4 LED Drivers

Typical Operating Characteristics (continued)

($V_{IN} = 3.3V$, $T_A = +25^\circ C$, unless otherwise noted.)

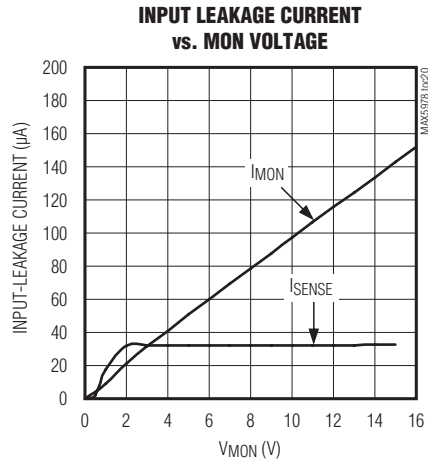
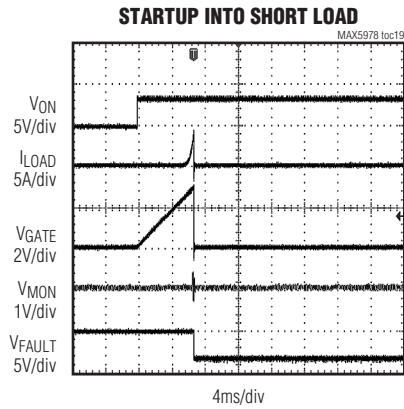
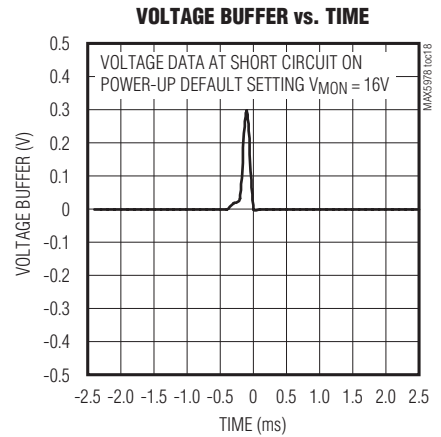
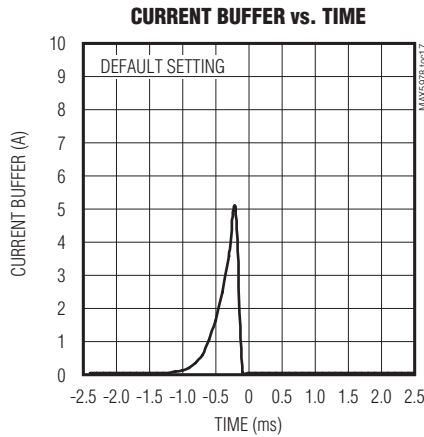
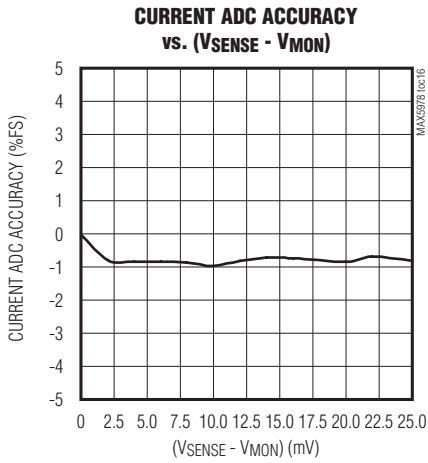

0 to 16V, Hot-Swap Controller with 10-Bit Current, Voltage Monitor, and 4 LED Drivers

MAX5978

Pin Configuration

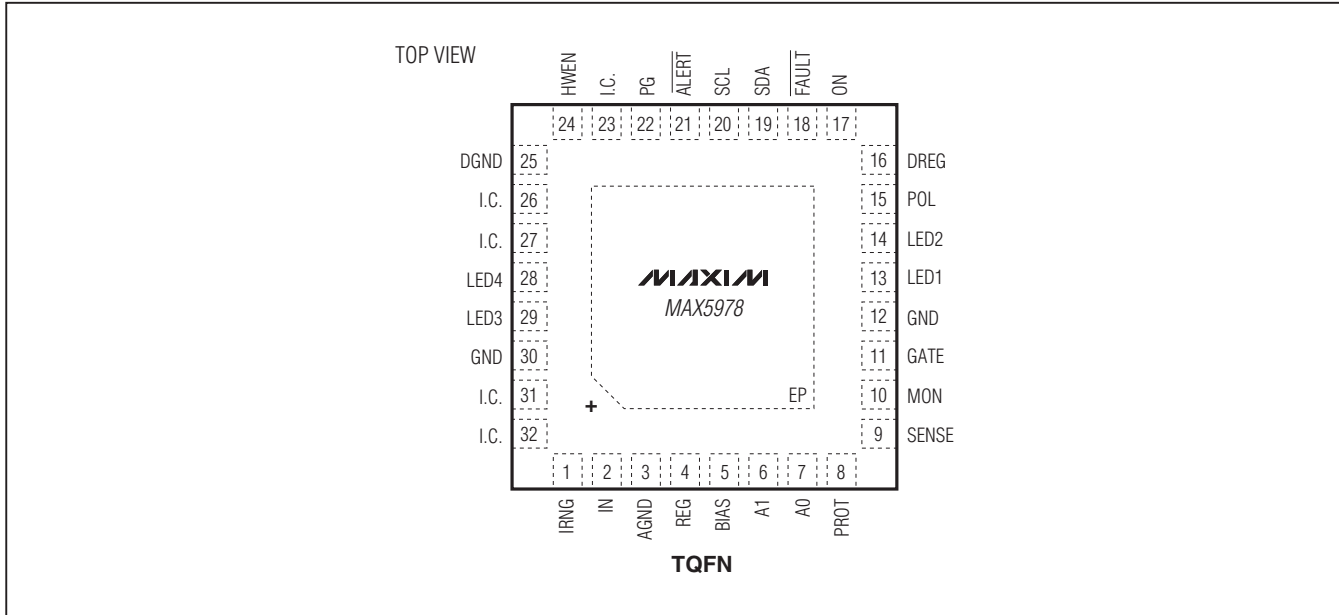

Pin Description

PIN	NAME	FUNCTION
1	IRNG	Three-State Current-Sense Range Selection Input. Set the circuit-breaker threshold range by connecting to DGND, DREG, or leave unconnected.
2	IN	Power-Supply Input. Connect to a voltage from 2.7V to 16V. Bypass IN to AGND with a 1 μ F ceramic capacitor.
3	AGND	Analog Ground. Connect all GND and DGND to AGND externally using a star connection.
4	REG	Internal Regulator Output. Bypass REG to ground with a 1 μ F ceramic capacitor. Connect only to DREG and logic-input pullup resistors. Do not use to power external circuitry.
5	BIAS	BIAS Input. Connect BIAS to REG.
6	A1	Three-State I ² C Address Input 1
7	A0	Three-State I ² C Address Input 0
8	PROT	Protection Behavior Input. Three-state input sets one of three different response options for undervoltage and overvoltage events.
9	SENSE	Current-Sense Input. Connect SENSE to the source of an external MOSFET and to one end of RSENSE.
10	MON	Voltage-Monitoring Input
11	GATE	Gate-Drive Output. Connect to the gate of an external n-channel MOSFET.
12	GND	Gate-Discharge Current Ground Return. Connect all GND and DGND to AGND externally using a star connection.
13	LED1	LED1 Driver
14	LED2	LED2 Driver

0 to 16V, Hot-Swap Controller with 10-Bit Current, Voltage Monitor, and 4 LED Drivers

Pin Description (continued)

PIN	NAME	FUNCTION
15	POL	Polarity Select Input. Connect POL to DREG for an active-high power-good (PG) output, or connect POL to GND for active-low PG output.
16	DREG	Logic Power-Supply Input. Connect to REG externally through a 10 Ω resistor and bypass to DGND with a 1 μ F ceramic capacitor.
17	ON	Precision Turn-On Input
18	$\overline{\text{FAULT}}$	Active-Low Open-Drain Fault Output. $\overline{\text{FAULT}}$ asserts low if an overcurrent event occurs.
19	SDA	I ² C Serial Data Input/Output
20	SCL	I ² C Serial Clock Input
21	$\overline{\text{ALERT}}$	Open-Drain Alert Output. $\overline{\text{ALERT}}$ goes low during a fault to notify the system of an impending failure.
22	PG	Open-Drain Power-Good Output
23, 26, 27, 31, 32	I.C.	Internally Connected. Connect to ground.
24	HWEN	Hardware Enable Input. Connect to REG or DGND. State is read upon power-up as V_{IN} crosses the UVLO threshold and sets enable register bits with this value. After UVLO, this input becomes inactive until power is cycled.
25	DGND	Digital Ground. Connect all GND and DGND to AGND externally using a star connection.
28	LED4	LED Driver 4
29	LED3	LED Driver 3
30	GND	Ground
—	EP	Exposed Pad. EP is internally grounded. Connect EP to the ground plane using a star connection.

0 to 16V, Hot-Swap Controller with 10-Bit Current, Voltage Monitor, and 4 LED Drivers

Typical Operating Circuit

MAX5978

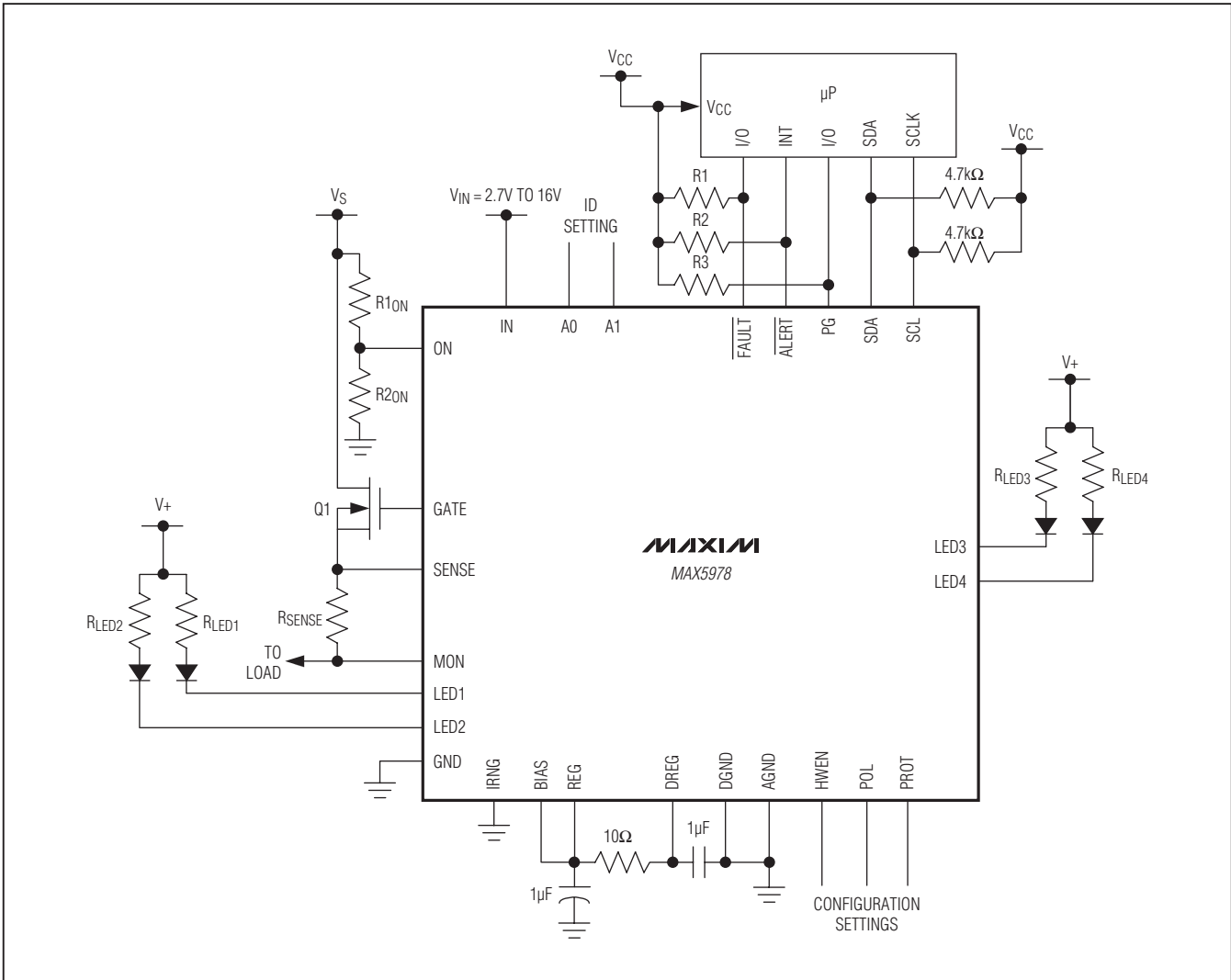

0 to 16V, Hot-Swap Controller with 10-Bit Current, Voltage Monitor, and 4 LED Drivers

Functional Diagram

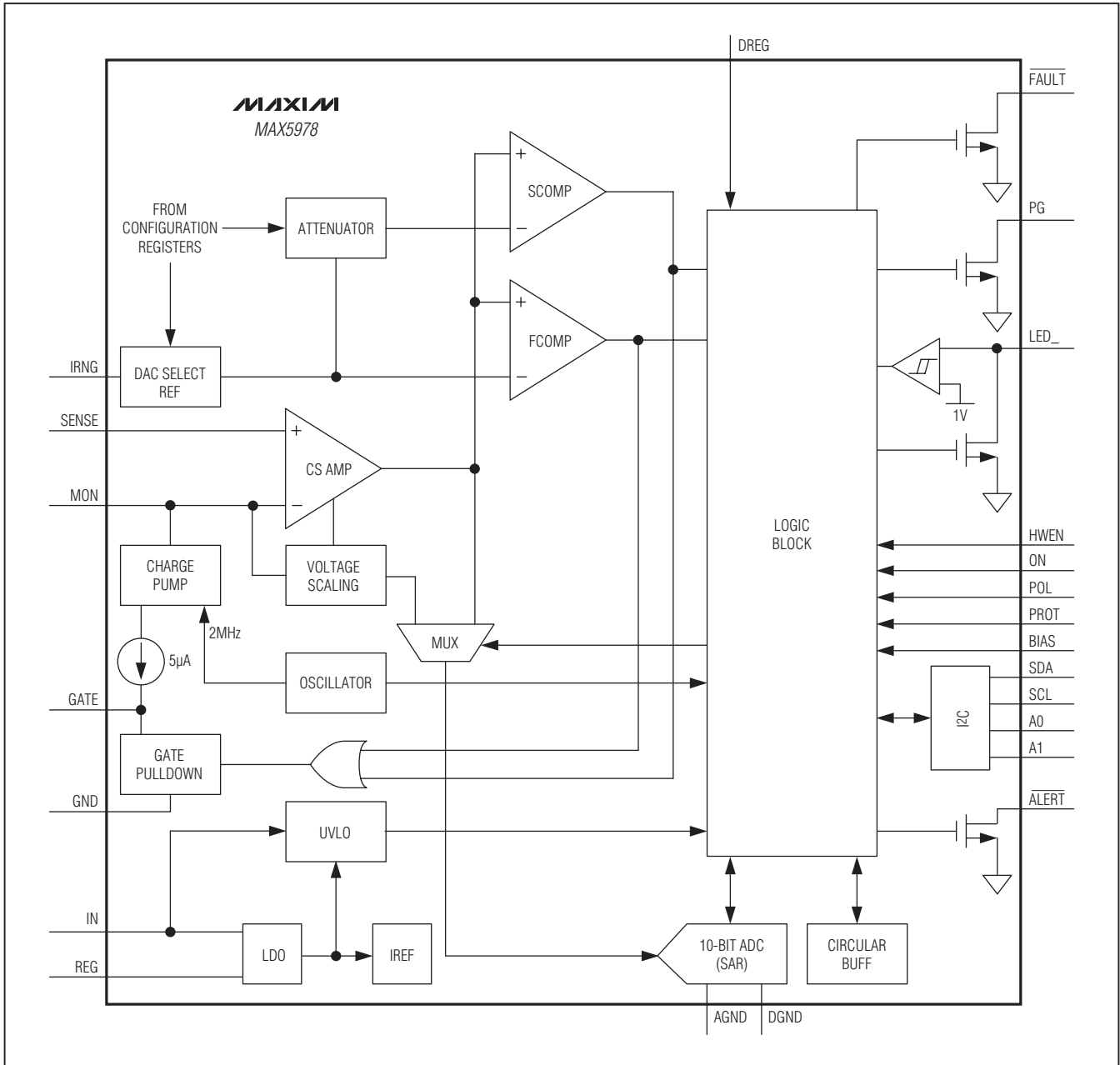

0 to 16V, Hot-Swap Controller with 10-Bit Current, Voltage Monitor, and 4 LED Drivers

Detailed Description

The MAX5978 includes a set of registers that are accessed through the I²C interface. Some of the registers are read only and some of the registers are read and write registers that can be updated to configure the device for a specific operation. See Tables 1a and 1b for the register maps.

Hot-Swap Channel On-Off Control

Depending on the configuration of the EN1 and EN2 bits, when V_{IN} is above the V_{UVLO} threshold and the ON input reaches its internal threshold, the device turns on the external n-channel MOSFET for the hot-swap channel, allowing power to flow to the load. The channel is enabled depending on the output of a majority function.

EN1, EN2, and ON are the inputs to the majority function and the channel is enabled when two or more of these inputs are 1:

$$(\text{Channel enabled}) = (\text{EN1} \times \text{EN2}) + (\text{EN1} \times \text{ON}) + (\text{EN2} \times \text{ON})$$

Inputs ON and EN2 can be set externally; the initial state of the EN2 bit in register chxen is set by the state of the HWEN input when V_{IN} rises above V_{UVLO}. The ON input connects to an internal precision analog comparators with a 0.6V threshold. Whenever V_{ON} is above 0.6V, the ON bit in register status1[0] is set to 1. Inputs EN1 and EN2 can be set using the I²C interface; the EN1 bit has a default value of 0. This makes it possible to enable or disable the hot-swap channel with or without using the I²C interface (see Tables 2, 3a, and 3b).

Table 1a. Register Address Map (Channel Specific)

REGISTER NAME	DESCRIPTION	REGISTER NUMBER	RESET VALUE	READ/ WRITE
adc_cs_msb	High 8 bits ([9:2]) of latest current-signal ADC result	0x00	0x00	R
adc_cs_lsb	Low 2 bits ([1:0]) of latest current-signal ADC result	0x01	0x00	R
adc_mon_msb	High 8 bits ([9:2]) of latest voltage-signal ADC result	0x02	0x00	R
adc_mon_lsb	Low 2 bits ([1:0]) of latest voltage-signal ADC result	0x03	0x00	R
min_cs_msb	High 8 bits ([9:2]) of current-signal minimum value	0x08	0xFF	R
min_cs_lsb	Low 2 bits ([1:0]) of current-signal minimum value	0x09	0x03	R
max_cs_msb	High 8 bits ([9:2]) of current-signal maximum value	0x0A	0x00	R
max_cs_lsb	Low 2 bits ([1:0]) of current-signal maximum value	0x0B	0x00	R
min_mon_msb	High 8 bits ([9:2]) of voltage-signal minimum value	0x0C	0xFF	R
min_mon_lsb	Low 2 bits ([1:0]) of voltage-signal minimum value	0x0D	0x03	R
max_mon_msb	High 8 bits ([9:2]) of voltage-signal maximum value	0x0E	0x00	R
max_mon_lsb	Low 2 bits ([1:0]) of voltage-signal maximum value	0x0F	0x00	R
uv1th_msb	High 8 bits ([9:2]) of undervoltage warning (UV1) threshold	0x1A	0x00	R/W
uv1th_lsb	Low 2 bits ([1:0]) of undervoltage warning (UV1) threshold	0x1B	0x00	R/W
uv2th_msb	High 8 bits ([9:2]) of undervoltage critical (UV2) threshold	0x1C	0x00	R/W
uv2th_lsb	Low 2 bits ([1:0]) of undervoltage critical (UV2) threshold	0x1D	0x00	R/W
ov1thr_msb	High 8 bits ([9:2]) of overvoltage warning (OV1) threshold	0x1E	0xFF	R/W
ov1thr_lsb	Low 2 bits ([1:0]) of overvoltage warning (OV1) threshold	0x1F	0x03	R/W
ov2thr_msb	High 8 bits ([9:2]) of overvoltage critical (OV2) threshold	0x20	0xFF	R/W
ov2thr_lsb	Low 2 bits ([1:0]) of overvoltage critical (OV2) threshold	0x21	0x03	R/W
oithr_msb	High 8 bits ([9:2]) of overcurrent warning threshold	0x22	0xFF	R/W
oithr_lsb	Low 2 bits ([1:0]) of overcurrent warning threshold	0x23	0x03	R/W
dac_fast	Fast-comparator threshold DAC setting	0x2E	0xBF	R/W
cbuf_ba_v	Base address for block read of 50-sample voltage-signal data buffer	0x46	—	R
cbuf_ba_i	Base address for block read of 50-sample current-signal data buffer	0x47	—	R

0 to 16V, Hot-Swap Controller with 10-Bit Current, Voltage Monitor, and 4 LED Drivers

Table 1b. Register Address Map (General)

REGISTER NAME	DESCRIPTION	ADDRESS (HEX CODE)	RESET VALUE	READ/ WRITE
mon_range	MON input range setting	0x18	0x00	R/W
cbuf_chx_store	Selective enabling of circular buffer	0x19	0x0F	R/W
ifast2slow	Current threshold fast-to-slow ratio setting	0x30	0x0F	R/W
status0	Slow-trip and fast-trip comparators status register	0x31	0x00	R
status1	PROT, MODE, and ON inputs status register	0x32	—	R
status2	Fast-trip threshold maximum range setting bits, from IRNG three-state input	0x33	—	R/W
status3	LATCH, POL, $\overline{\text{ALERT}}$, and PG status register	0x34	—	R
fault0	Status register for undervoltage detection (warning or critical)	0x35	0x00	R/C
fault1	Status register for overvoltage detection (warning or critical)	0x36	0x00	R/C
fault2	Status register for overcurrent detection (warning)	0x37	0x00	R/C
pgdly	Delay setting between MON measurement and PG assertion	0x38	0x00	R/W
fokey	Load register with 0xA5 to enable force-on function	0x39	0x00	R/W
foset	Register that enables force-on function	0x3A	0x00	R/W
chxen	Channel enable bits	0x3B	—	R/W
dgl_i	OC deglitch enable bits	0x3C	0x00	R/W
dgl_uv	UV deglitch enable bits	0x3D	0x00	R/W
dgl_ov	OV deglitch enable bits	0x3E	0x00	R/W
cbufrd_hibyonly	Circular buffers readout mode: 8 bit or 10 bit	0x3F	0x0F	R/W
cbuf_dly_stop	Circular buffer stop delay; number of samples recorded to the circular buffer after channel shutdown	0x40	0x19	R/W
peak_log_rst	Reset control bits for peak-detection registers	0x41	0x00	R/W
peak_log_hold	Hold control bits for peak-detection registers	0x42	0x00	R/W
LED_flash	LED flash/GPIO enable register	0x43	0x0F	R/W
LED_ph_pu	LED phase/weak pullup enable register	0x44	0x00	R/W
LED_state	LED pins voltage state register (LED pins set open)	0x45	—	R

Table 2. chxen Register Format

Description:		Channel enable bits							
Register Title:		chxen							
Register Address:		0x3B							
R	R	R	R	R/W	R/W	R/W	R/W	RESET VALUE	
—	—	—	—	Unused	Unused	EN2	EN1	—	
Bit 7	Bit 6	Bit 5	Bit 4	Bit 3	Bit 2	Bit 1	Bit 0	—	

0 to 16V, Hot-Swap Controller with 10-Bit Current, Voltage Monitor, and 4 LED Drivers

Table 3a. Register Function

REGISTER ADDRESS	BIT RANGE	DESCRIPTION
0x32	[1:0]	ON input state
		1 = ON above 600mV channel enable threshold
		0 = ON below 600mV channel enable threshold
		Bit 0: ON input state
		Bit 1: unused
	[4]	Unused
	[7:6]	Voltage critical behavior (PROT input)
		00 = Assert $\overline{\text{ALERT}}$ upon UV/OV critical (same as UV/OV warning behavior)
		01 = Assert $\overline{\text{ALERT}}$ and deassert PG upon UV/OV critical
		10 = Assert $\overline{\text{ALERT}}$, deassert PG, and shut down channel upon UV/OV critical
11 = (Not possible)		

Table 3b. status1 Register Format

Description:		Fault-detection behavior (three-state PROT input) and ON input status register						
Register Title:		status1						
Register Address:		0x32						
R	R	R	R	R	R	R	R	RESET VALUE
prot[1]	prot[0]	—	Unused	—	—	Unused	ON	—
Bit 7	Bit 6	Bit 5	Bit 4	Bit 3	Bit 2	Bit 1	Bit 0	—

Figure 1 shows the detailed logic operation of the hot-swap enable signals EN1, EN2, and ON, as well as the effect of various fault conditions.

An input undervoltage threshold control for enabling the hot-swap channel can be implemented by placing a resistive divider between the drain of the hot-swap MOSFET and ground, with the midpoint connected to ON. The turn-on threshold voltage for the channel is then:

$$V_{EN} = 0.6V \times (R1 + R2)/R2$$

The maximum rating for the ON input is 6V; do not exceed this value.

Startup

When all conditions for channel turn-on are met, the external n-channel MOSFET switch is fully enhanced with a typical gate-to-source voltage of 5V to ensure a low drain-to-source resistance. The charge pump at the GATE driver sources 5 μ A to control the output voltage turn-on voltage slew rate. An external capacitor can be added from GATE to GND to further reduce the

voltage slew rate. Placing a 1k Ω resistor in series with this capacitance prevents the added capacitance from increasing the gate turn-off time. Total inrush current is the load current summed with the product of the gate-voltage slew rate dV/dt and the load capacitance.

To determine the output dV/dt during startup, divide the GATE pullup current I_{G(UP)} by the gate-to-ground capacitance. The voltage at the source of the external MOSFET follows the gate voltage, so the load dV/dt is the same as the gate dV/dt. Inrush current is the product of the dV/dt and the load capacitance. The time to start up t_{SU} is the hot-swap voltage V_S divided by the output dV/dt.

Be sure to choose an external MOSFET that can handle the power dissipated during startup. The inrush current is roughly constant during startup and the voltage drop across the MOSFET (drain to source) decreases linearly as the load capacitance charges. The resulting power dissipation is, therefore, roughly equivalent to a single pulse of magnitude (V_S x inrush current)/2 and

0 to 16V, Hot-Swap Controller with 10-Bit Current, Voltage Monitor, and 4 LED Drivers

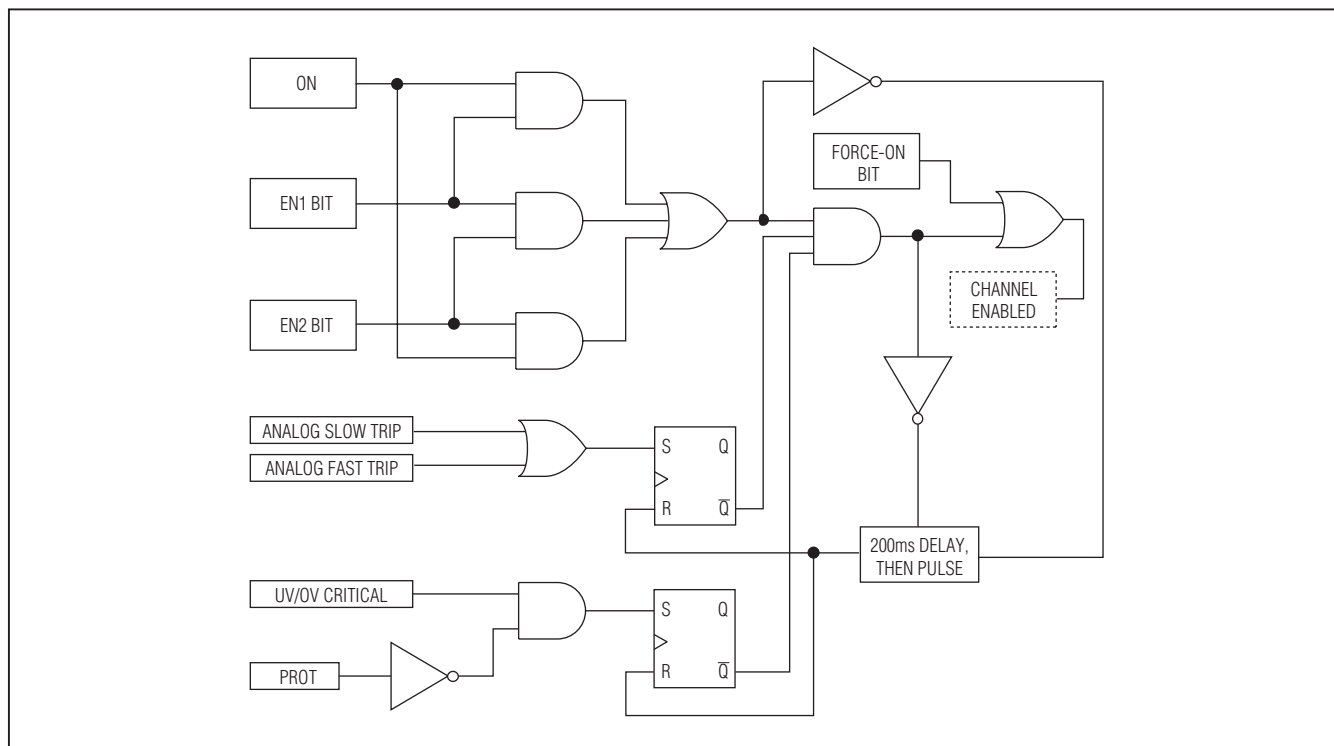

Figure 1. Channel On-Off Control Logic Functional Schematic

duration t_{SU} . Refer to the thermal resistance charts in the MOSFET data sheet to determine the junction temperature rise during startup, and ensure that this does not exceed the maximum junction temperature for worst-case ambient conditions.

Circuit-Breaker Protection

As the channel is turned on and during normal operation, two analog comparators are used to detect an overcurrent condition by sensing the voltage across an external resistor connected between SENSE and MON. If the voltage across the sense resistor is less than the slow-trip and fast-trip circuit-breaker thresholds, the GATE output remains high. If either of the thresholds is exceeded due to an overcurrent condition, the gate of the MOSFET is pulled down to MON by an internal 500mA current source.

The higher of the two comparator thresholds, the fast trip, is set by an internal 8-bit DAC (see Table 7), within one of three configurable full-scale current-sense

ranges: 25mV, 50mV, or 100mV (see Tables 6a and 6b). The 8-bit fast-trip threshold DAC can be programmed from 40% to 100% of the selected full-scale current-sense range. The slow-trip threshold follows the fast-trip threshold as one of four programmable ratios, set by the ifast2slow register (see Tables 4a and 4b).

The fast-trip threshold is always higher than the slow-trip threshold, and the fast-trip comparator responds very quickly to protect the system against sudden, severe overcurrent events. The slower response of the slow-trip comparator varies depending upon the amount of overdrive beyond the slow-trip threshold. If the overdrive is small and short lived, the comparator will not shut down the affected channel. As the overcurrent event increases in magnitude, the response time of the slow-trip comparator decreases. This scheme provides good noise rejection and spurious overcurrent transients near the slow-trip threshold, while aggressively protecting the system against larger overcurrent events that occur as a result of a load fault.

0 to 16V, Hot-Swap Controller with 10-Bit Current, Voltage Monitor, and 4 LED Drivers

Table 4a. ifast2slow Register Format

Description:		Current threshold fast-to-slow setting bits						RESET VALUE
Register Title:		ifast2slow						
Register Address:		0x30						
R	R	R	R	R/W	R/W	R/W	R/W	
—	—	—	—	Unused	Unused	FS1	FS0	0x0F
Bit 7	Bit 6	Bit 5	Bit 4	Bit 3	Bit 2	Bit 1	Bit 0	—

Table 4b. Setting Fast-Trip to Slow-Trip Threshold Ratio

FS1	FS0	FAST-TRIP TO SLOW-TRIP RATIO (%)
0	0	125
0	1	150
1	0	175
1	1	200

Setting Circuit-Breaker Thresholds

To select and set the device slow-trip and fast-trip comparator thresholds, use the following procedure:

- 1) Select one of four ratios between the fast-trip threshold and the slow-trip threshold: 200%, 175%, 150%, or 125%. A system that experiences brief but large transient load currents should use a higher ratio, whereas a system that operates continuously at higher average load currents might benefit from a smaller ratio to ensure adequate protection. The ratio is set by writing to the ifast2slow register. (The default setting on power-up is 200%.)
- 2) Determine the slow-trip threshold $V_{TH,ST}$ based on the anticipated maximum continuous load current during normal operation, and the value of the current-sense resistor. The slow-trip threshold should include some margin (possibly 20%) above the maximum load current to prevent spurious circuit-breaker shutdown and to accommodate passive component tolerances:

$$V_{TH,ST} = R_{SENSE} \times I_{LOAD,MAX} \times 120\%$$

- 3) Calculate the necessary fast-trip threshold $V_{TH,FT}$ based on the ratio set in step 1:

$$V_{TH,FT} = V_{TH,ST} \times (\text{ifast2slow ratio})$$

- 4) Select one of the three maximum current-sense ranges: 25mV, 50mV, or 100mV. The current-sense

range is initially set upon power-up by the state of the IRNG input, but can be altered at any time by writing to the status2 register. For maximum accuracy and best measurement resolution, select the lowest current-sense range that is larger than the $V_{TH,FT}$ value calculated in step 3.

- 5) Program the fast-trip and slow-trip thresholds by writing an 8-bit value to the dac_fast register. This 8-bit value is determined from the desired $V_{TH,ST}$ value that was calculated in step 2, the threshold ratio from step 1, and the current-sense range from step 4:

$$DAC = V_{TH,ST} \times 255 \times (\text{ifast2slow ratio}) / (\text{IRNG current-sense range})$$

The device provides a great deal of system flexibility because the current-sense range, DAC setting, and threshold ratio can be changed “on the fly” for systems that must protect a wide range of interchangeable load devices, or for systems that control the allocation of power to smart loads. Table 5 shows the specified ranges for the fast-trip and slow-trip thresholds for all combinations of current-sense range and threshold ratio.

When an overcurrent event causes the device to shut down the power channel, the open-drain $\overline{\text{FAULT}}$ output alerts the system. Figure 2 shows the operation and fault-management flowchart.

0 to 16V, Hot-Swap Controller with 10-Bit Current, Voltage Monitor, and 4 LED Drivers

Table 5. Specified Current-Sense and Circuit-Breaker Threshold Ranges

IRNG INPUT	DAC OUTPUT RANGE (DEFAULT = FULL SCALE) (mV)	FAST-TRIP THRESHOLD RANGE (mV)	GAIN (2 BIT) (VFAST/VsLOW) ifast2slow (DEFAULT = 11)	SLOW-TRIP THRESHOLD RANGE (mV)
Low	10 to 25	10 to 25	00 (125%)	8.00 to 20.00
			01 (150%)	6.67 to 16.67
			10 (175%)	5.71 to 14.29
			11 (200%)	5.00 to 12.50
High	20 to 50	20 to 50	00 (125%)	16.00 to 40.00
			01 (150%)	13.33 to 33.33
			10 (175%)	11.48 to 28.57
			11 (200%)	10.00 to 25.00
Unconnected	40 to 100	40 to 100	00 (125%)	32.00 to 80.00
			01 (150%)	26.67 to 66.67
			10 (175%)	22.86 to 57.14
			11 (200%)	20.00 to 50.00

Table 6a. IRNG Input Status Register Format

Description:								Fast-trip threshold maximum range-setting bits, from IRNG three-state input
Register Title:								status2
Register Address:								0x33
R	R	R	R	R/W	R/W	R/W	R/W	RESET VALUE
—	—	—	—	Unused	Unused	IRNG1	IRNG0	—
Bit 7	Bit 6	Bit 5	Bit 4	Bit 3	Bit 2	Bit 1	Bit 0	—

Table 6b. Setting Current-Sense Range

IRNG PIN STATE	IRNG1	IRNG0	MAXIMUM CURRENT-SENSE SIGNAL (mV)
Low	1	0	25
High	0	1	50
Open	0	0	100

Table 7. dac_ch_ Register Format

Description:								Fast-comparator threshold DAC setting
Register Title:								dac_fast
Register Addresses:								0x2E
R/W	R/W	R/W	R/W	R/W	R/W	R/W	R/W	RESET VALUE
DAC[7]	DAC[6]	DAC[5]	DAC[4]	DAC[3]	DAC[2]	DAC[1]	DAC[0]	0xBF
Bit 7	Bit 6	Bit 5	Bit 4	Bit 3	Bit 2	Bit 1	Bit 0	—

0 to 16V, Hot-Swap Controller with 10-Bit Current, Voltage Monitor, and 4 LED Drivers

MAX5978

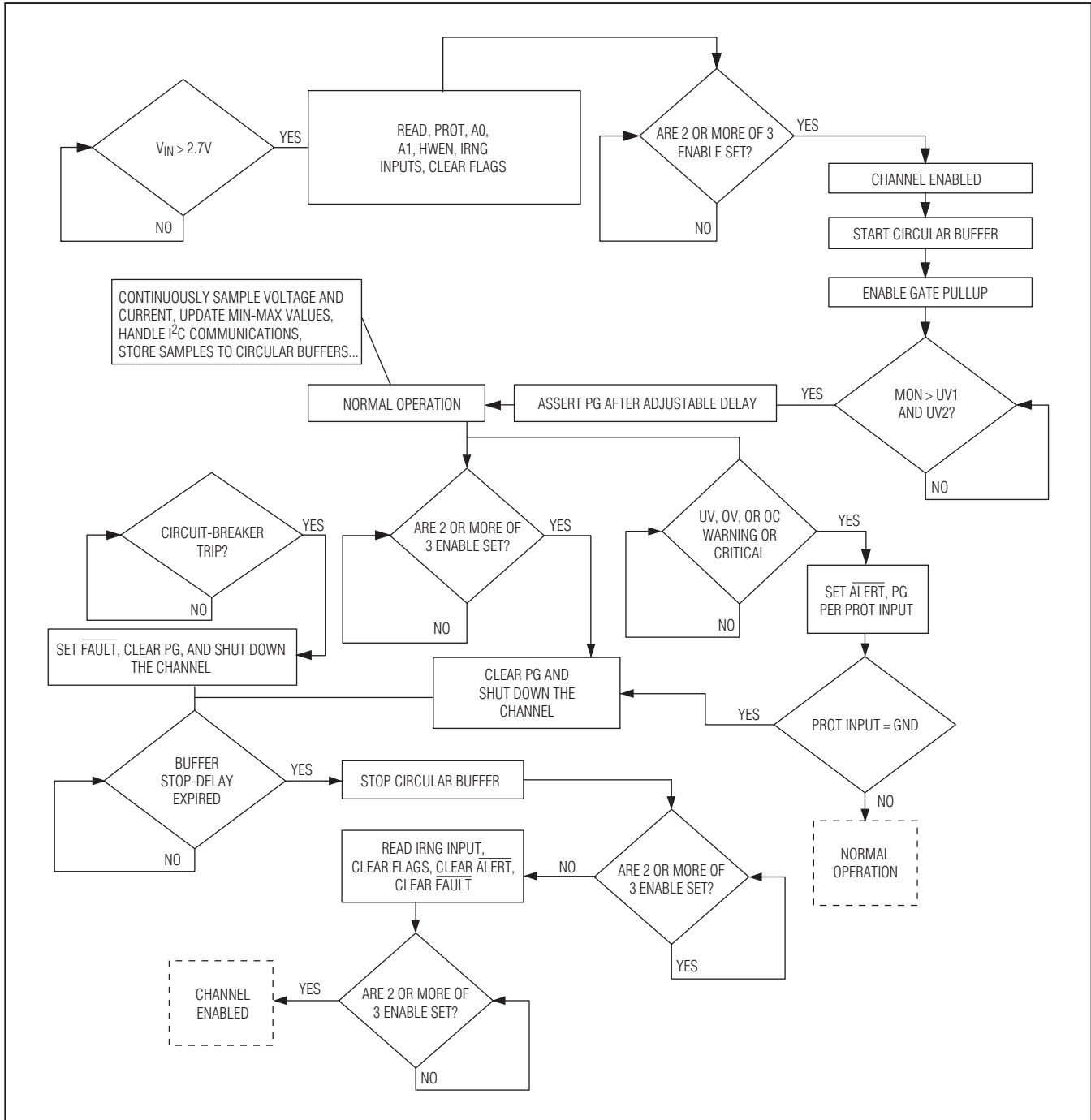

Figure 2. Operation and Fault-Management Flowchart for Hot-Swap Channel

0 to 16V, Hot-Swap Controller with 10-Bit Current, Voltage Monitor, and 4 LED Drivers

Digital Current Monitoring

The current-sense signal is sampled by the internal 10-bit, 10ksps ADC, and the most recent results are stored in registers for retrieval through the I²C interface. The current conversion values are 10 bits wide, with the 8 high-order bits written to one 8-bit register and the 2 low-order bits written to the next-higher 8-bit register address (Tables 8 and 9). This allows use of just the high-order byte in applications where 10-bit precision is not required. This split 8-bit/2-bit storage scheme is used

throughout the device for ADC conversion results and digital comparator thresholds.

Once the PG output is asserted, the current-sense samples are continuously compared to the programmable overcurrent warning register value. If the measured current value exceeds the warning level, the $\overline{\text{ALERT}}$ output is asserted. The device response to this digital comparator is not altered by the setting of the PROT input (Tables 10 and 11).

Table 8. ADC Current-Conversion Results Register Format (High-Order Bits)

Description:		Most recent current-conversion result, high-order bits [9:2]						
Register Title:		adc_cs_msb						
Register Addresses:		0x00						
R	R	R	R	R	R	R	R	RESET VALUE
inew_9	inew_8	inew_7	inew_6	inew_5	inew_4	inew_3	inew_2	0x00
Bit 7	Bit 6	Bit 5	Bit 4	Bit 3	Bit 2	Bit 1	Bit 0	—

Table 9. ADC Current-Conversion Results Register Format (Low-Order Bits)

Description:		Most recent current-conversion result, low-order bits [0:1]						
Register Title:		adc_cs_lsb						
Register Addresses:		0x01						
R	R	R	R	R	R	R	R	RESET VALUE
—	—	—	—	—	—	inew_1	inew_0	0x00
Bit 7	Bit 6	Bit 5	Bit 4	Bit 3	Bit 2	Bit 1	Bit 0	—

Table 10. Overcurrent Warning Threshold Register Format (High-Order Bits)

Description:		Overcurrent warning threshold high-order bits [9:2]						
Register Title:		oithr_msb						
Register Addresses:		0x22						
R/W	R/W	R/W	R/W	R/W	R/W	R/W	R/W	RESET VALUE
oi_9	oi_8	oi_7	oi_6	oi_5	oi_4	oi_3	oi_2	0xFF
Bit 7	Bit 6	Bit 5	Bit 4	Bit 3	Bit 2	Bit 1	Bit 0	—

Table 11. Overcurrent Warning Threshold Register Format (Low-Order Bits)

Description:		Overcurrent warning threshold low-order bits [1:0]						
Register Title:		oithr_lsb						
Register Addresses:		0x23						
R/W	R/W	R/W	R/W	R/W	R/W	R/W	R/W	RESET VALUE
—	—	—	—	—	—	oi_1	oi_0	0x03
Bit 7	Bit 6	Bit 5	Bit 4	Bit 3	Bit 2	Bit 1	Bit 0	—

0 to 16V, Hot-Swap Controller with 10-Bit Current, Voltage Monitor, and 4 LED Drivers

Minimum and Maximum Value Detection for Current-Measurement Values

Current-sense measurement values from the ADC are continuously compared with the contents of minimum- and maximum-value registers, and if the most recent measurement exceeds the stored maximum, or is less than the stored minimum, the corresponding register

is updated with the new value. These “peak-detection” registers are read/write accessible through the I²C interface (Tables 12–15). The minimum-value registers are reset to 0xFF and the maximum-value registers are reset to 0x00. These reset values are loaded upon startup of the channel or at any time as commanded by register peak_log_rst (Table 35).

Table 12. ADC Minimum Current-Conversion Register Format (High-Order Bits)

Description:		Minimum current-conversion result high-order bits [9:2]						
Register Title:		min_cs_msb						
Register Addresses:		0x08						
R	R	R	R	R	R	R	R	RESET VALUE
imin_9	imin_8	imin_7	imin_6	imin_5	imin_4	imin_3	imin_2	0xFF
Bit 7	Bit 6	Bit 5	Bit 4	Bit 3	Bit 2	Bit 1	Bit 0	—

Table 13. ADC Minimum Current-Conversion Register Format (Low-Order Bits)

Description:		Minimum current-conversion result low-order bits [1:0]						
Register Title:		min_cs_lsb						
Register Addresses:		0x09						
R	R	R	R	R	R	R	R	RESET VALUE
—	—	—	—	—	—	imin_1	imin_0	0x03
Bit 7	Bit 6	Bit 5	Bit 4	Bit 3	Bit 2	Bit 1	Bit 0	—

Table 14. ADC Maximum Current-Conversion Register Format (High-Order Bits)

Description:		Maximum current-conversion result high-order bits [9:2]						
Register Title:		max_cs_msb						
Register Addresses:		0x0A						
R	R	R	R	R	R	R	R	RESET VALUE
imax_9	imax_8	imax_7	imax_6	imax_5	imax_4	imax_3	imax_2	0x00
Bit 7	Bit 6	Bit 5	Bit 4	Bit 3	Bit 2	Bit 1	Bit 0	—

Table 15. ADC Maximum Current-Conversion Register Format (Low-Order Bits)

Description:		Maximum current-conversion result low-order bits [1:0]						
Register Title:		max_cs_lsb						
Register Addresses:		0x0B						
R	R	R	R	R	R	R	R	RESET VALUE
—	—	—	—	—	—	imax_1	imax_0	0x00
Bit 7	Bit 6	Bit 5	Bit 4	Bit 3	Bit 2	Bit 1	Bit 0	—

0 to 16V, Hot-Swap Controller with 10-Bit Current, Voltage Monitor, and 4 LED Drivers

Digital Voltage Monitoring and Power-Good Output

The voltage at the load (MON input) is sampled by the internal ADC. The MON full-scale voltage can be set to 16V, 8V, 4V, or 2V by writing to register `mon_range`. The default range is 16V (Tables 16 and 17).

The most recent voltage-conversion results can be read from the `adc_mon_msb` and `adc_mon_lsb` registers (see Tables 18 and 19).

Digital Undervoltage- and Overvoltage-Detection Thresholds

The most recent voltage values are continuously compared to four programmable limits, comprising two undervoltage (UV) levels (see Tables 20 to 23) and two overvoltage (OV) levels (see Tables 24 to 27).

If PG is asserted and the voltage is outside the warning limits, the $\overline{\text{ALERT}}$ output is asserted low. Depending on the status of the `prot[]` bits in register `status1[7:6]`, the

Table 16. ADC Voltage Monitor Settings Register Format

Description:		ADC voltage monitor full-scale range settings (for MON input)						RESET VALUE
Register Title:		<code>mon_range</code>						0x00
Register Addresses:		0x18						—
R/W	R/W	R/W	R/W	R/W	R/W	R/W	R/W	RESET VALUE
—	—	—	—	Unused	Unused	MON_rng1	MON_rng0	0x00
Bit 7	Bit 6	Bit 5	Bit 4	Bit 3	Bit 2	Bit 1	Bit 0	—

Table 17. ADC Full-Scale Voltage Setting

MON_rng1	MON_rng0	ADC FULL-SCALE VOLTAGE (V)
0	0	16
0	1	8
1	0	4
1	1	2

Table 18. ADC Voltage-Conversion Result Register Format (High-Order Bits)

Description:		Most recent voltage-conversion result, high-order bits [9:2]						RESET VALUE
Register Title:		<code>adc_mon_msb</code>						0x00
Register Addresses:		0x02						—
R	R	R	R	R	R	R	R	RESET VALUE
vnew_9	vnew_8	vnew_7	vnew_6	vnew_5	vnew_4	vnew_3	vnew_2	0x00
Bit 7	Bit 6	Bit 5	Bit 4	Bit 3	Bit 2	Bit 1	Bit 0	—

Table 19. ADC Voltage-Conversion Result Register Format (Low-Order Bits)

Description:		Most recent voltage-conversion result, low-order bits [1:0]						RESET VALUE
Register Title:		<code>adc_mon_lsb</code>						0x00
Register Addresses:		0x03						—
R	R	R	R	R	R	R	R	RESET VALUE
—	—	—	—	—	—	vnew_1	vnew_0	0x00
Bit 7	Bit 6	Bit 5	Bit 4	Bit 3	Bit 2	Bit 1	Bit 0	—

0 to 16V, Hot-Swap Controller with 10-Bit Current, Voltage Monitor, and 4 LED Drivers

device can also deassert the PG output or turn off the external MOSFET when the voltage is outside the critical limits (see Figure 3). Table 28 shows the behavior for the three possible states of the PROT input. Note that the PROT input does not affect the device response to the UV or OV warning digital comparators; it only determines the system response to the critical digital comparators (see Tables 3a, 3b, and 28).

In a typical application, the UV1 and OV1 thresholds would be set closer to the nominal output voltage, and the UV2 and OV2 thresholds would be set further from nominal. This provides a “progressive” response to a voltage excursion. However, the thresholds can be configured in any arrangement or combination as desired to suit a given application.

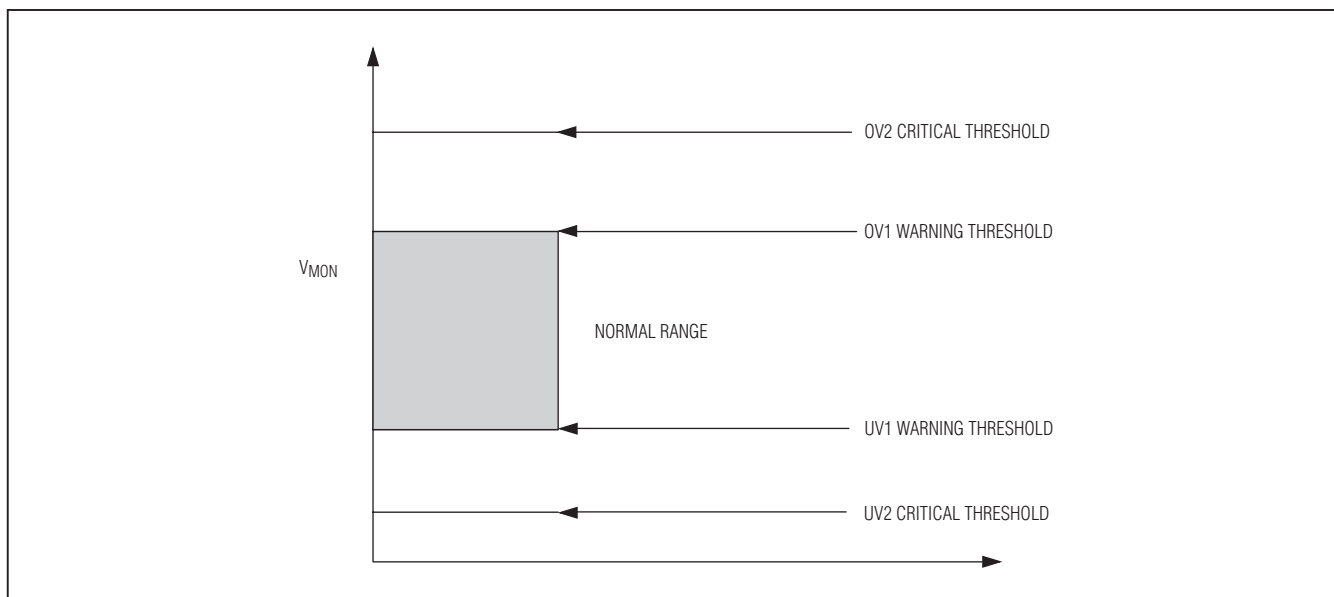

Figure 3. Graphical Representation of Typical UV and OV Thresholds Configuration

Table 20. Undervoltage Warning Threshold Register Format (High-Order Bits)

Description:		Undervoltage warning threshold high-order bits [9:2]						RESET VALUE
Register Title:		uv1th_msb						
Register Addresses:		0x1A						
R/W	R/W	R/W	R/W	R/W	R/W	R/W	R/W	
uv1_9	uv1_8	uv1_7	uv1_6	uv1_5	uv1_4	uv1_3	uv1_2	0x00
Bit 7	Bit 6	Bit 5	Bit 4	Bit 3	Bit 2	Bit 1	Bit 0	—

Table 21. Undervoltage Warning Threshold Register Format (Low-Order Bits)

Description:		Undervoltage warning threshold low-order bits [1:0]						RESET VALUE
Register Titles:		uv1th_lsb						
Register Addresses:		0x1B						
R	R	R	R	R	R	R/W	R/W	
—	—	—	—	—	—	uv1_1	uv1_0	0x00
Bit 7	Bit 6	Bit 5	Bit 4	Bit 3	Bit 2	Bit 1	Bit 0	—

0 to 16V, Hot-Swap Controller with 10-Bit Current, Voltage Monitor, and 4 LED Drivers

Table 22. Undervoltage Critical Threshold Register Format (High-Order Bits)

Description:		Undervoltage critical threshold high-order bits [9:2]						
Register Title:		uv2th_msb						
Register Addresses:		0x1C						
R/W	R/W	R/W	R/W	R/W	R/W	R/W	R/W	RESET VALUE
uv2_9	uv2_8	uv2_7	uv2_6	uv2_5	uv2_4	uv2_3	uv2_2	0x00
Bit 7	Bit 6	Bit 5	Bit 4	Bit 3	Bit 2	Bit 1	Bit 0	—

Table 23. Undervoltage Critical Threshold Register Format (Low-Order Bits)

Description:		Undervoltage critical threshold low-order bits [1:0]						
Register Title:		uv2th_lsb						
Register Addresses:		0x1D						
R	R	R	R	R	R	R/W	R/W	RESET VALUE
—	—	—	—	—	—	uv2_1	uv2_0	0x00
Bit 7	Bit 6	Bit 5	Bit 4	Bit 3	Bit 2	Bit 1	Bit 0	—

Table 24. Overvoltage Warning Threshold Register Format (High-Order Bits)

Description:		Overvoltage warning threshold high-order bits [9:2]						
Register Title:		ov1thr_msb						
Register Addresses:		0x1E						
R/W	R/W	R/W	R/W	R/W	R/W	R/W	R/W	RESET VALUE
ov1_9	ov1_8	ov1_7	ov1_6	ov1_5	ov1_4	ov1_3	ov1_2	0xFF
Bit 7	Bit 6	Bit 5	Bit 4	Bit 3	Bit 2	Bit 1	Bit 0	—

Table 25. Overvoltage Warning Threshold Register Format (Low-Order Bits)

Description:		Overvoltage warning threshold low-order bits [1:0]						
Register Title:		ov1thr_lsb						
Register Addresses:		0x1F						
R	R	R	R	R	R	R/W	R/W	RESET VALUE
—	—	—	—	—	—	ov1_1	ov1_0	0x03
Bit 7	Bit 6	Bit 5	Bit 4	Bit 3	Bit 2	Bit 1	Bit 0	—

Table 26. Overvoltage Critical Threshold Register Format (High-Order Bits)

Description:		Overvoltage critical threshold high-order bits [9:2]						
Register Title:		ov2thr_msb						
Register Addresses:		0x20						
R/W	R/W	R/W	R/W	R/W	R/W	R/W	R/W	RESET VALUE
ov2_9	ov2_8	ov2_7	ov2_6	ov2_5	ov2_4	ov2_3	ov2_2	0xFF
Bit 7	Bit 6	Bit 5	Bit 4	Bit 3	Bit 2	Bit 1	Bit 0	—

0 to 16V, Hot-Swap Controller with 10-Bit Current, Voltage Monitor, and 4 LED Drivers

Table 27. Overvoltage Critical Threshold Register Format (Low-Order Bits)

Description:		Overvoltage critical threshold low-order bits [1:0]							
Register Title:		ov2thr_lsb							
Register Addresses:		0x21							
R	R	R	R	R	R/W	R/W	R/W	RESET VALUE	
—	—	—	—	—	—	ov2_1	ov2_0	0x03	
Bit 7	Bit 6	Bit 5	Bit 4	Bit 3	Bit 2	Bit 1	Bit 0	—	

Table 28. PROT Input and prot[] Bits

PROT INPUT STATE	prot[1]	prot[0]	UV/OV WARNING ACTION	UV/OV CRITICAL ACTION
Low	0	0	Assert $\overline{\text{ALERT}}$	Assert $\overline{\text{ALERT}}$, clear PG, shut down channel
High	0	1	Assert $\overline{\text{ALERT}}$	Assert $\overline{\text{ALERT}}$, clear PG
Unconnected	1	0	Assert $\overline{\text{ALERT}}$	Assert $\overline{\text{ALERT}}$

Table 29. status3 Register Format

Description:		Power-good status register: POL, ALERT, and power-good bits							
Register Title:		status3							
Register Address:		0x34							
R	R	R	R/W	R	R	R	R	RESET VALUE	
—	—	POL	ALERT	—	—	Unused	pg[0]	—	
Bit 7	Bit 6	Bit 5	Bit 4	Bit 3	Bit 2	Bit 1	Bit 0	—	

Table 30a. Power-Good Assertion Delay-Time Register Format

Description:		Power-good assertion delay-time register							
Register Title:		pgdly							
Register Address:		0x38							
R	R	R	R	R/W	R/W	R/W	R/W	RESET VALUE	
—	—	—	—	Unused	Unused	pgdly1	pgdly0	0x00	
Bit 7	Bit 6	Bit 5	Bit 4	Bit 3	Bit 2	Bit 1	Bit 0	—	

Table 30b. Power-Good Assertion Delay

pgdly1	pgdly0	PG ASSERTION DELAY (ms)
0	0	50
0	1	100
1	0	200
1	1	400

Power-Good Detection and PG Output

The PG output is asserted when the voltage at MON is between the undervoltage and overvoltage critical limits. The status of the power-good signal is maintained in register status3[0]. A value of 1 in the pg[] bit indicates

a power-good condition, regardless of the POL setting, which only affects the PG output pin polarity. The open-drain PG output can be configured for active-high or active-low status indication by the state of the POL input (see Table 29).

The POL input sets the value of status3[5], which is a read-only bit; the state of the POL input can be changed at any time during operation and the polarity of the PG output changes accordingly.

The assertion of the PG output is delayed by a user-selectable time delay of 50ms, 100ms, 200ms, or 400ms (see Tables 30a and 30b).

0 to 16V, Hot-Swap Controller with 10-Bit Current, Voltage Monitor, and 4 LED Drivers

Minimum and Maximum Value Detection for Voltage-Measurement Values

All voltage-measurement values are compared with the contents of minimum- and maximum-value registers, and if the most recent measurement exceeds the stored maximum or is less than the stored minimum, the corresponding register is updated with the new value. These

peak-detection registers are read accessible through the I²C interface (see Tables 31 to 34). The minimum-value registers are reset to 0xFF, and the maximum-value registers are reset to 0x00. These reset values are loaded upon startup or at any time as commanded by register peak_log_rst (see Table 35).

Table 31. ADC Minimum Voltage Conversion Register Format (High-Order Bits)

Description:		Minimum voltage conversion result, high-order bits [9:2]						RESET VALUE
Register Title:		min_mon_msb						
Register Addresses:		0x0C						
R	R	R	R	R	R	R	R	
vmin_9	vmin_8	vmin_7	vmin_6	vmin_5	vmin_4	vmin_3	vmin_2	0xFF
Bit 7	Bit 6	Bit 5	Bit 4	Bit 3	Bit 2	Bit 1	Bit 0	—

Table 32. ADC Minimum Voltage-Conversion Register Format (Low-Order Bits)

Description:		Minimum voltage-conversion result, low-order bits [1:0]						RESET VALUE
Register Title:		min_mon_lsb						
Register Addresses:		0x0D						
R	R	R	R	R	R	R	R	
—	—	—	—	—	—	vmin_1	vmin_0	0x03
Bit 7	Bit 6	Bit 5	Bit 4	Bit 3	Bit 2	Bit 1	Bit 0	—

Table 33. ADC Maximum Voltage-Conversion Register Format (High-Order Bits)

Description:		Maximum voltage-conversion result, high-order bits [9:2]						RESET VALUE
Register Title:		max_mon_msb						
Register Addresses:		0x0E						
R	R	R	R	R	R	R	R	
vmax_9	vmax_8	vmax_7	vmax_6	vmax_5	vmax_4	vmax_3	vmax_2	0x00
Bit 7	Bit 6	Bit 5	Bit 4	Bit 3	Bit 2	Bit 1	Bit 0	—

Table 34. ADC Maximum Voltage-Conversion Register Format (Low-Order Bits)

Description:		Maximum voltage-conversion result, low-order bits [1:0]						RESET VALUE
Register Title:		max_mon_lsb						
Register Addresses:		0x0F						
R	R	R	R	R	R	R	R	
—	—	—	—	—	—	vmax_1	vmax_0	0x00
Bit 7	Bit 6	Bit 5	Bit 4	Bit 3	Bit 2	Bit 1	Bit 0	—

0 to 16V, Hot-Swap Controller with 10-Bit Current, Voltage Monitor, and 4 LED Drivers

Using the Voltage and Current Peak-Detection Registers

The voltage and current minimum- and maximum-value records in register locations 0x08 through 0x17 can be reset by writing a 1 to the appropriate location in register peak_log_rst (see Table 35). The minimum-value registers are reset to 0xFF, and the maximum-value registers are reset to 0x00.

As long as a bit in peak_log_rst is 1, the corresponding peak-detection registers are disabled and are “cleared” to their power-up reset values. The voltage and current

minimum- and maximum-detection register contents can be “held” by setting bits in register peak_log_hold (see Table 36). Writing a 1 to a location in peak_log_hold locks the register contents for the corresponding signal and stops the min/max detection and logging; writing a 0 enables the detection and logging. Note that the peak-detection registers cannot be cleared while they are held by register peak_log_hold.

The combination of these two control registers allows the user to monitor voltage and current peak-to-peak values during a particular time period.

Table 35. Peak-Detection Reset-Control Register Format

Description:		Reset control bits for peak-detection registers							
Register Title:		peak_log_rst							
Register Address:		0x41							
R	R	R	R	R/W	R/W	R/W	R/W	RESET VALUE	
—	—	—	—	Unused	Unused	v_rst	i_rst	0x00	
Bit 7	Bit 6	Bit 5	Bit 4	Bit 3	Bit 2	Bit 1	Bit 0	—	

Table 36. Peak-Detection Hold-Control Register Format

Description:		Hold control bits for peak-detection registers							
Register Title:		peak_log_hold							
Register Address:		0x42							
R	R	R	R	R/W	R/W	R/W	R/W	RESET VALUE	
—	—	—	—	Unused	Unused	Ch0_v_hld	Ch0_i_hld	0x00	
Bit 7	Bit 6	Bit 5	Bit 4	Bit 3	Bit 2	Bit 1	Bit 0	—	

0 to 16V, Hot-Swap Controller with 10-Bit Current, Voltage Monitor, and 4 LED Drivers

Table 37. OI Warning Comparators Deglitch Enable Register Format

Description:		Deglitch enable register for overcurrent warning digital comparators								
Register Title:		dgl_i								
Register Address:		0x3C								
R	R	R	R	R	R	R/W	R/W	RESET VALUE		
—	—	—	—	—	—	Unused	dgl_i	0x00		
Bit 7	Bit 6	Bit 5	Bit 4	Bit 3	Bit 2	Bit 1	Bit 0	—		

Table 38. UV Warning and Critical Comparators Deglitch Enable Register Format

Description:		Deglitch enable register for undervoltage warning and critical digital comparators								
Register Title:		dgl_uv								
Register Address:		0x3D								
R	R	R	R	R/W	R/W	R/W	R/W	RESET VALUE		
—	—	—	—	Unused	Unused	dgl_uv2	dgl_uv1	0x00		
Bit 7	Bit 6	Bit 5	Bit 4	Bit 3	Bit 2	Bit 1	Bit 0	—		

Table 39. OV Warning and Critical Comparators Deglitch Enable Register Format

Description:		Deglitch enable register for overvoltage warning and critical digital comparators								
Register Title:		dgl_ov								
Register Address:		0x3E								
R	R	R	R	R/W	R/W	R/W	R/W	RESET VALUE		
—	—	—	—	Unused	Unused	dgl_ov2	dgl_ov1	0x00		
Bit 7	Bit 6	Bit 5	Bit 4	Bit 3	Bit 2	Bit 1	Bit 0	—		

Deglitching of Digital Comparators

The five digital comparators (undervoltage/overvoltage warning and critical, overcurrent warning) all have a user-selectable deglitching feature that requires two consecutive positive compares before the device takes action as determined by the particular compare and the setting of the PROT input.

The deglitching functions are enabled or disabled by registers dgl_i, dgl_uv, and dgl_ov (Tables 37, 38, and 39). Writing a 1 to the appropriate bit location in these registers enables the deglitch function for the corresponding digital comparator.

Circular Buffer

The device features two 10-bit “circular buffers” (in volatile memory) that contain a history of the 50 most-recent voltage and current digital-conversion results. These circular buffers can be read back through the I²C interface.

The recording of new data to the buffer for a given signal is stopped under any of the following conditions:

- The hot-swap channel is shut down because of a fault condition.
- A read of the circular buffer base address is performed through the I²C interface.
- The hot-swap channel is turned off by a combination of the EN1, EN2, or ON signals.

The buffers allow the user to recall the voltage and current waveforms for analysis and troubleshooting. The buffer contents are accessed through the I²C interface at two fixed addresses in the device register address space (see Table 40).

Each buffer can also be stopped under user control by register cbuf_chx_store (see Table 41).

0 to 16V, Hot-Swap Controller with 10-Bit Current, Voltage Monitor, and 4 LED Drivers

The contents of a buffer can be retrieved as a block read of either fifty 10-bit values (spanning 2 bytes each) or of 50 high-order bytes, depending on the per-signal bit settings of register `cbufrd_hibyonly` (see Table 42).

If the circular buffer contents are retrieved as 10-bit data, the first byte read-out is the high-order 8 bits of the 10-bit sample, and the second byte read-out contains the 2 least-significant bits (LSBs) of the sample. This is repeated for each of the 50 samples in the buffer. Thus, 2 bytes must be read for each 10-bit sample retrieved. Conversely, if the buffer contents are retrieved as 8-bit data, then each byte read-out contains the 8 MSBs of each successive sample. It is important to remember that in 10-bit mode, 100 bytes must be read to extract the entire buffer contents, but in 8-bit mode, only 50 bytes must be read.

The circular buffer system has a user-programmable “stop delay” that specifies a certain number of sample cycles to continue recording to the buffer after a shutdown occurs. This delay value is stored in register `cbuf_dly_stop[5:0]` (see Table 43).

The default (reset) value of the buffer stop delay is 25 samples, which means that an equal number of samples are stored in the buffer preceding and following the moment of the shutdown event. The buffer stop delay is analogous to an oscilloscope trigger delay because it allows the device to record what happened both immediately before and after a shutdown. In other words, when the contents of a circular buffer are read out of the device, the shutdown event is by default located in the middle of the recorded data. The balance of data before and after an event can be altered by writing a different value (between 0 and 50) to the buffer stop-delay register.

Latched-Off Fault Management

In the event of an overcurrent, undervoltage, or overvoltage condition that results in the shutdown of the hot-swap channel, the device remains latched off.

To restart the latched-off channel, the user must either cycle power to the IN input, or toggle the ON pin, EN1 bit, or the EN2 bit.

Table 40. Circular Buffer Read Addresses

ADDRESS	NAME	DESCRIPTION
0x46	<code>cbuf_ba_v</code>	Base address for voltage buffer block read
0x47	<code>cbuf_ba_i</code>	Base address for current buffer block read

Table 41. Circular Buffer Control Register Format

Description:		Circular buffer run-stop control register (per-buffer control: 1 = run, 0 = stop)						RESET VALUE	
Register Title:		<code>cbuf_chx_store</code>							
Register Address:		0x19							
R	R	R	R	R/W	R/W	R/W	R/W	RESET VALUE	
—	—	—	—	Unused	Unused	Ch0_i_run	Ch0_v_run		0x0F
Bit 7	Bit 6	Bit 5	Bit 4	Bit 3	Bit 2	Bit 1	Bit 0		—

Table 42. Circular Buffer Resolution Register Format

Description:		Circular buffer read-out resolution: high-order byte only, or 8-2 split 10-bit data (per-buffer control: 1 = high-order byte output, 0 = full-resolution 10-bit output)						RESET VALUE	
Register Title:		<code>cbufrd_hibyonly</code>							
Register Address:		0x3F							
R	R	R	R	R/W	R/W	R/W	R/W	RESET VALUE	
—	—	—	—	Unused	Unused	i_res	v_res		0x0F
Bit 7	Bit 6	Bit 5	Bit 4	Bit 3	Bit 2	Bit 1	Bit 0		—

0 to 16V, Hot-Swap Controller with 10-Bit Current, Voltage Monitor, and 4 LED Drivers

Table 43. Circular Buffer Stop-Delay Register Format

Description:		Circular buffer stop delay: any integer number between 0 and 50 samples that are to be recorded to a buffer after a shutdown event, before the buffer stops storing new data						RESET VALUE
Register Title:		cbuf_dly_stop						
Register Address:		0x40						
R	R	R/W	R/W	R/W	R/W	R/W	R/W	RESET VALUE
0	0	Stop_dly[5]	Stop_dly[4]	Stop_dly[3]	Stop_dly[2]	Stop_dly[1]	Stop_dly[0]	0x19
Bit 7	Bit 6	Bit 5	Bit 4	Bit 3	Bit 2	Bit 1	Bit 0	—

Table 44. Force-On Control Register Format

Description:		Force-on control register						RESET VALUE
Register Title:		foset						
Register Address:		0x3A						
R	R	R	R	R	R	R/W	R/W	RESET VALUE
0	0	0	0	0	0	Unused	fo	0x00
Bit 7	Bit 6	Bit 5	Bit 4	Bit 3	Bit 2	Bit 1	Bit 0	—

Table 45. Force-On Key Register Format

Description:		Force-on key register (must contain 0xA5 to unlock force-on feature)						RESET VALUE
Register Title:		fokey						
Register Address:		0x39						
R/W	R/W	R/W	R/W	R/W	R/W	R/W	R/W	RESET VALUE
fokey[7]	fokey[6]	fokey[5]	fokey[4]	fokey[3]	fokey[2]	fokey[1]	fokey[0]	0x00
Bit 7	Bit 6	Bit 5	Bit 4	Bit 3	Bit 2	Bit 1	Bit 0	—

Force-On Function

When the force-on bit is set to 1 in register foset[0] (see Table 44), the channel is enabled regardless of the ON pin voltage or the EN1 and EN2 bits in register chxn. In forced-on operation, all functions operate normally with the notable exception that the channel does not shut down due to any fault conditions that may arise.

There is a force-on key register fokey that must be set to 0xA5 in order for the force-on function to become active (see Table 45). If this register contains any value other

than 0xA5, writing 1 to the force-on bits in register foset has no effect. This provides protection against accidental force-on operation that might otherwise be caused by an erroneous I²C write.

Fault Logging and Indications

The device provides detailed information about any fault conditions that have occurred. The FAULT output specifically indicates a circuit-breaker shutdown event, while the ALERT output is asserted whenever a problem has occurred that requires attention or interaction.

0 to 16V, Hot-Swap Controller with 10-Bit Current, Voltage Monitor, and 4 LED Drivers

Fault Dependency

If a fault event occurs (digital UV warning/critical, digital OV warning/critical, or digital overcurrent warning), the fault is logged by setting a corresponding bit in registers fault0, fault1, or fault2 (see Tables 46, 47, and 48).

Likewise, circuit-breaker shutdown events are logged in register status0[7:0] (see Table 49).

IFAULTS indicates the overcurrent status from slow comparator. IFAULTF indicates overcurrent status from fast comparator. The status of $\overline{\text{FAULT}}$ reflects the OR operation of IFAULTS and IFAULTF.

These fault register bits latch upon a fault condition, and must be reset manually by restarting as described in the *Latched-Off Fault Management* section.

Table 46. Undervoltage Status Register Format

Description:		Undervoltage digital-compare status register (warning [0] and critical [4] undervoltage event-detection status)						RESET VALUE
Register Title:		fault0						0x00
Register Address:		0x35						—
R	R	R/C	R/C	R	R	R/C	R/C	
—	—	Unused	uv1	—	—	Unused	uv1	
Bit 7	Bit 6	Bit 5	Bit 4	Bit 3	Bit 2	Bit 1	Bit 0	

Table 47. Overvoltage Status Register Format

Description:		Overvoltage digital-compare status register (warning [0] and critical [4] overvoltage event-detection status)						RESET VALUE
Register Title:		fault1						0x00
Register Address:		0x36						—
R	R	R/C	R/C	R	R	R/C	R/C	
—	—	Unused	ov2	—	—	Unused	ov1	
Bit 7	Bit 6	Bit 5	Bit 4	Bit 3	Bit 2	Bit 1	Bit 0	

Table 48. Overcurrent Warning Status Register Format

Description:		Overcurrent digital-compare status register (overcurrent warning event-detection status)						RESET VALUE
Register Title:		fault2						0x00
Register Address:		0x37						—
R	R	R	R	R	R	R/C	R/C	
—	—	—	—	—	—	Unused	oi	
Bit 7	Bit 6	Bit 5	Bit 4	Bit 3	Bit 2	Bit 1	Bit 0	

Table 49. Circuit-Breaker Event Logging Register Format

Description:		Circuit-breaker slow- and fast-trip event logging						RESET VALUE
Register Title:		status0						0x00
Register Address:		0x31						—
R	R	R	R	R	R	R	R	
—	—	Unused	IFAULTS	—	—	Unused	IFAULTF	
Bit 7	Bit 6	Bit 5	Bit 4	Bit 3	Bit 2	Bit 1	Bit 0	

0 to 16V, Hot-Swap Controller with 10-Bit Current, Voltage Monitor, and 4 LED Drivers

FAULT Output

When an overcurrent event (fast trip or slow trip) causes the device to shut down the hot-swap channel, an open-drain $\overline{\text{FAULT}}$ output is asserted low. Note that the $\overline{\text{FAULT}}$ output is not asserted for shutdowns caused by critical undervoltage or overvoltage events.

The $\overline{\text{FAULT}}$ output is cleared when the channel is disabled by pulling ON low or by clearing the bits in register chxen.

ALERT Output

$\overline{\text{ALERT}}$ is an open-drain output that is asserted low any time that a fault or other condition requiring attention has occurred. The state of the $\overline{\text{ALERT}}$ output is also indicated by status3[4].

The $\overline{\text{ALERT}}$ output is the logical NOR of registers 0x31, 0x35, 0x36, and 0x37, so when the $\overline{\text{ALERT}}$ output goes low, the system microcontroller should query these registers through the I²C interface to determine the cause of the $\overline{\text{ALERT}}$ assertion.

LED Set Registers

The device has four open-drain LED drivers/user-programmable GPIOs. When programmed as LED drivers, each driver can sink up to 25mA of current. Table 50 shows the register that enables the drivers as either LED drivers or GPIOs.

When any of the LED_ Set bit in the register is set to 1, the corresponding open-drain LED driver is turned off. The LED_Flash bits enable each corresponding LED driver to flash on and off at 1Hz frequency regardless of the condition of the corresponding LED_ Set bit.

Bits 7–4 in Table 51 set the LED flashing drivers to be either in-phase or out-of-phase with the internal 1Hz clock. Bits 3–0 enable the 4μA pullup current to the corresponding output.

Table 52 shows the LED state register. The LED state register is a read-only register. When the LEDs are disabled, the pins are configured as GPIOs. Applying an external voltage below 0.4V sets the GPIOs low and, applying an external voltage above 1.4V, sets the GPIOs high.

Table 50. LED_Flash/GPIO Enable Register

Description:		LED_flash/GPIO enable register						
Register Title:		LED_flash						
Register Address:		0x43						
R/W	R/W	R/W	R/W	R/W	R/W	R/W	R/W	RESET VALUE
LED4 Flash	LED3 Flash	LED2 Flash	LED1 Flash	LED4 Set	LED3 Set	LED2 Set	LED1 Set	0x0F
Bit 7	Bit 6	Bit 5	Bit 4	Bit 3	Bit 2	Bit 1	Bit 0	—

Table 51. LED Phase/Weak Pullup Enable Register

Description:		LED phase/weak pullup enable						
Register Title:		LED_ph_pu						
Register Address:		0x44						
R/W	R/W	R/W	R/W	R/W	R/W	R/W	R/W	RESET VALUE
LED4 Phase	LED3 Phase	LED2 Phase	LED1 Phase	LED4 Weak PU	LED3 Weak PU	LED2 Weak PU	LED1 Weak PU	0x00
Bit 7	Bit 6	Bit 5	Bit 4	Bit 3	Bit 2	Bit 1	Bit 0	—

0 to 16V, Hot-Swap Controller with 10-Bit Current, Voltage Monitor, and 4 LED Drivers

Table 52. LED State Register

Description:		LED state register						
Register Title:		LED_state						
Register Address:		0x45						
R	R	R	R	R	R	R	R	RESET VALUE
—	—	—	—	LED4 Voltage	LED3 Voltage	LED2 Voltage	LED1 Voltage	—
Bit 7	Bit 6	Bit 5	Bit 4	Bit 3	Bit 2	Bit 1	Bit 0	—

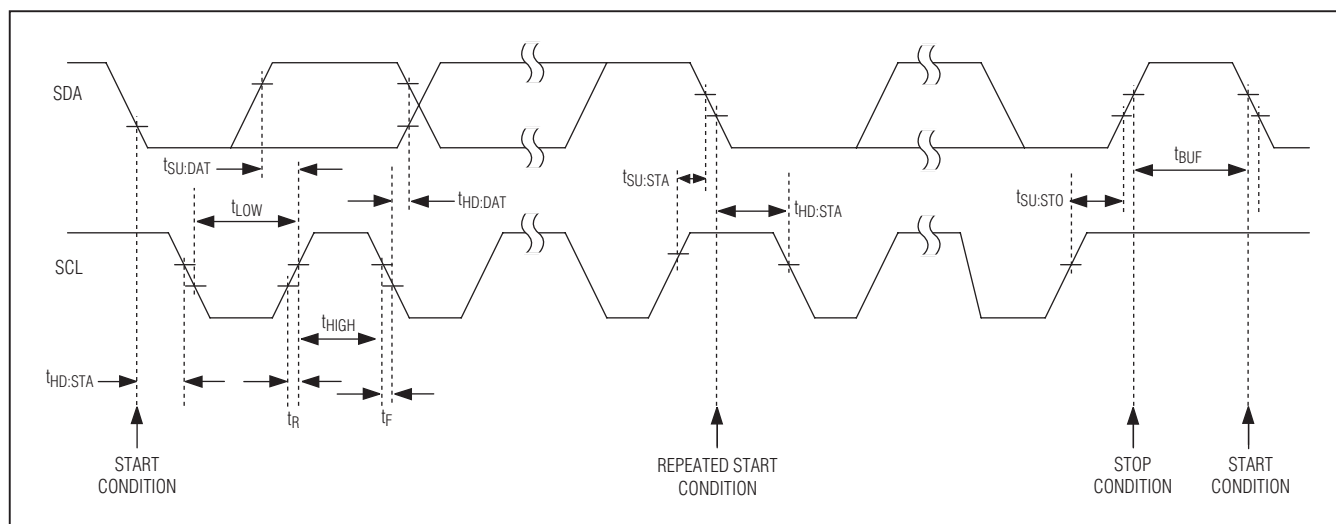

Figure 4. Serial-Interface Timing Details

I²C Serial Interface

The device features an I²C-compatible serial interface consisting of a serial data line (SDA) and a serial clock line (SCL). SDA and SCL allow bidirectional communication between the device and the master device at clock rates from 100kHz to 400kHz. The I²C bus can have several devices (e.g., more than one device, or other I²C devices in addition to the device) attached simultaneously. The A0 and A1 inputs set one of nine possible I²C addresses (see Table 53).

The 2-wire communication is fully compatible with existing 2-wire serial interface systems; Figure 4 shows the interface timing diagram. The device is a transmit/receive slave-only device, relying upon a master device

to generate a clock signal. The master device (typically a microcontroller) initiates data transfer on the bus and generates SCL to permit that transfer.

A master device communicates to the device by transmitting the proper address followed by command and/or data words. Each transmit sequence is framed by a START (S) or Repeated START (SR) condition and a STOP (P) condition. Each word transmitted over the bus is 8 bits long and is always followed by an acknowledge pulse.

SCL is a logic input, while SDA is a logic input/open-drain output. SCL and SDA both require external pullup resistors to generate the logic-high voltage. Use 4.7kΩ for most applications.

0 to 16V, Hot-Swap Controller with 10-Bit Current, Voltage Monitor, and 4 LED Drivers

Table 53. Device Slave Address Settings

ADDRESS INPUT STATE		I ² C ADDRESS BITS							
A1	A0	ADDR 7	ADDR 6	ADDR 5	ADDR 4	ADDR 3	ADDR 2	ADDR 1	ADDR 0
Low	Low	0	1	1	1	0	1	0	R/W
Low	High	0	1	1	1	0	0	1	R/W
Low	Open	0	1	1	1	0	0	0	R/W
High	Low	0	1	1	0	1	1	0	R/W
High	High	0	1	1	0	1	0	1	R/W
High	Open	0	1	1	0	1	0	0	R/W
Open	Low	0	1	1	0	0	1	0	R/W
Open	High	0	1	1	0	0	0	1	R/W
Open	Open	0	1	1	0	0	0	0	R/W

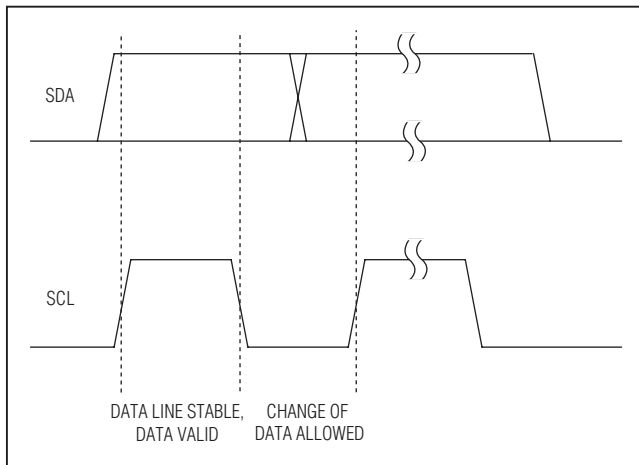

Figure 5. Bit Transfer

Bit Transfer

Each clock pulse transfers 1 data bit. The data on SDA must remain stable while SCL is high (see Figure 5); otherwise, the device registers a START or STOP condition (see Figure 6) from the master. SDA and SCL idle high when the bus is not busy.

START and STOP Conditions

Both SCL and SDA idle high when the bus is not busy. A master device signals the beginning of a transmission with a START condition (see Figure 3) by transitioning SDA from high to low while SCL is high. The master device issues a STOP condition (see Figure 6) by transitioning SDA from low to high while SCL is high. A STOP condition frees the bus for another transmission. The bus remains active if a Repeated START condition is generated, such as in the block read protocol (see Figure 7).

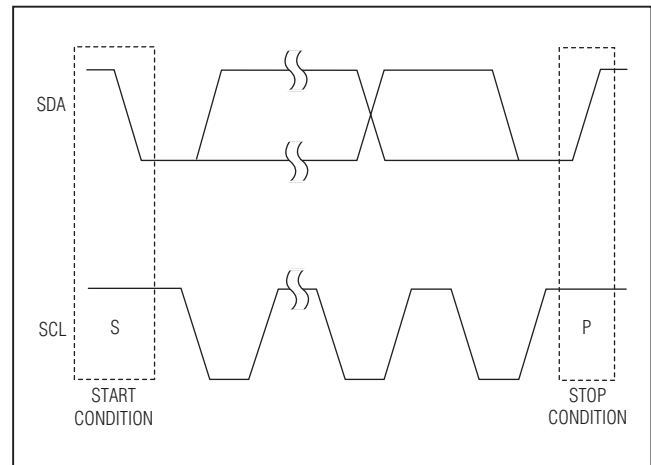

Figure 6. START and STOP Conditions

Early STOP Conditions

The device recognizes a STOP condition at any point during transmission except if a STOP condition occurs in the same high pulse as a START condition. This condition is not a legal I²C format. At least one clock pulse must separate any START and STOP condition.

Repeated START Conditions

A Repeated START (SR) condition may indicate a change of data direction on the bus. Such a change occurs when a command word is required to initiate a read operation (see Figure 4). SR may also be used when the bus master is writing to several I²C devices and does not want to relinquish control of the bus. The device serial interface supports continuous write operations with or without an SR condition separating them. Continuous read operations require SR conditions because of the change in direction of data flow.

0 to 16V, Hot-Swap Controller with 10-Bit Current, Voltage Monitor, and 4 LED Drivers

SEND BYTE FORMAT

S	ADDRESS	$\overline{\text{WR}}$	ACK	DATA	ACK	P
	7 BITS	0		8 BITS		

SLAVE ADDRESS—EQUIVALENT TO CHIP-SELECT LINE OF A 3-WIRE INTERFACE.
 DATA BYTE—PRESETS THE INTERNAL ADDRESS POINTER.

WRITE WORD FORMAT

S	ADDRESS	$\overline{\text{WR}}$	ACK	COMMAND	ACK	DATA	ACK	DATA	ACK	P
	7 BITS	0		8 BITS		8 BITS		8 BITS		

SLAVE ADDRESS—EQUIVALENT TO CHIP-SELECT LINE OF A 3-WIRE INTERFACE.
 COMMAND BYTE—MSB OF THE EEPROM REGISTER BEING WRITTEN.
 DATA BYTE—FIRST BYTE IS THE LSB OF THE EEPROM ADDRESS. SECOND BYTE IS THE ACTUAL DATA.

RECEIVE BYTE FORMAT

S	ADDRESS	$\overline{\text{WR}}$	ACK	DATA	$\overline{\text{ACK}}$	P
	7 BITS	1		8 BITS		

SLAVE ADDRESS—EQUIVALENT TO CHIP-SELECT LINE OF A 3-WIRE INTERFACE.
 DATA BYTE—READS DATA FROM THE REGISTER COMMANDED BY THE LAST READ BYTE OR WRITE BYTE TRANSMISSION. ALSO DEPENDENT ON A SEND BYTE.

WRITE BYTE FORMAT

S	ADDRESS	$\overline{\text{WR}}$	ACK	COMMAND	ACK	DATA	ACK	P
	7 BITS	0		8 BITS		8 BITS		

SLAVE ADDRESS—EQUIVALENT TO CHIP-SELECT LINE OF A 3-WIRE INTERFACE.
 COMMAND BYTE—SELECTS REGISTER BEING WRITTEN.
 DATA BYTE—DATA GOES INTO THE REGISTER SET BY THE COMMAND BYTE IF THE COMMAND IS BELOW 50h. IF THE COMMAND IS 80h, 81h, or 82h, THE DATA BYTE PRESETS THE LSB OF AN EEPROM ADDRESS.

BLOCK WRITE FORMAT

S	ADDRESS	$\overline{\text{WR}}$	ACK	COMMAND	ACK	BYTE COUNT = N	ACK	DATA BYTE 1	ACK	DATA BYTE ...	ACK	DATA BYTE N	ACK	P
	7 BITS	0		8 BITS		8 BITS		8 BITS		8 BITS		8 BITS		

SLAVE ADDRESS—EQUIVALENT TO CHIP-SELECT LINE OF A 3-WIRE INTERFACE.
 COMMAND BYTE—PREPARES DEVICE FOR BLOCK OPERATION.
 DATA BYTE—DATA GOES INTO THE REGISTER SET BY THE COMMAND BYTE.

BLOCK READ FORMAT

S	ADDRESS	$\overline{\text{WR}}$	ACK	COMMAND	ACK	Sr	ADDRESS	$\overline{\text{WR}}$	ACK	BYTE COUNT = 16	ACK	DATA BYTE 1	ACK	DATA BYTE ...	ACK	DATA BYTE N	ACK	P
	7 BITS	0		8 BITS			7 BITS	1		10h		8 BITS		8 BITS		8 BITS		

SLAVE ADDRESS—EQUIVALENT TO CHIP-SELECT LINE OF A 3-WIRE INTERFACE.
 COMMAND BYTE—PREPARES DEVICE FOR BLOCK OPERATION.
 SLAVE ADDRESS—EQUIVALENT TO CHIP-SELECT LINE OF A 3-WIRE INTERFACE.
 DATA BYTE—DATA GOES INTO THE REGISTER SET BY THE COMMAND BYTE.

S = START CONDITION SHADED = SLAVE TRANSMISSION
 P = STOP CONDITION Sr = REPEATED START CONDITION

Figure 7. SMBus/I²C Protocols

0 to 16V, Hot-Swap Controller with 10-Bit Current, Voltage Monitor, and 4 LED Drivers

Acknowledge

The acknowledge bit (ACK) is the 9th bit attached to any 8-bit data word. The receiving device always generates an ACK. The device generates an ACK when receiving an address or data by pulling SDA low during the 9th clock period (see Figure 8). When transmitting data, such as when the master device reads data back from the device, the device waits for the master device to generate an ACK. Monitoring ACK allows for detection of unsuccessful data transfers. An unsuccessful data transfer occurs if the receiving device is busy or if a system fault has occurred. In the event of an unsuccessful data transfer, the bus master should reattempt communication at a later time. The device generates a NACK after the slave address during a software reboot or when receiving an illegal memory address.

Send Byte

The send byte protocol allows the master device to send 1 byte of data to the slave device (see Figure 7). The send byte presets a register pointer address for a subsequent read or write. The slave sends a NACK instead of an ACK if the master tries to send an address that is not allowed. If the master sends a STOP condition, the internal address pointer does not change. The send byte procedure follows:

- 1) The master sends a START condition.
- 2) The master sends the 7-bit slave address and a write bit (low).

- 3) The addressed slave asserts an ACK on SDA.
- 4) The master sends an 8-bit data byte.
- 5) The addressed slave asserts an ACK on SDA.
- 6) The master sends a STOP condition.

Write Byte

The write byte/word protocol allows the master device to write a single byte in the register bank or to write to a series of sequential register addresses. The write byte procedure follows:

- 1) The master sends a START condition.
- 2) The master sends the 7-bit slave address and a write bit (low).
- 3) The addressed slave asserts an ACK on SDA.
- 4) The master sends an 8-bit command code.
- 5) The addressed slave asserts an ACK on SDA.
- 6) The master sends an 8-bit data byte.
- 7) The addressed slave asserts an ACK on SDA.
- 8) The addressed slave increments its internal address pointer.
- 9) The master sends a STOP condition or repeats steps 6, 7, and 8.

To write a single byte to the register bank, only the 8-bit command code and a single 8-bit data byte are sent. The data byte is written to the register bank if the command code is valid.

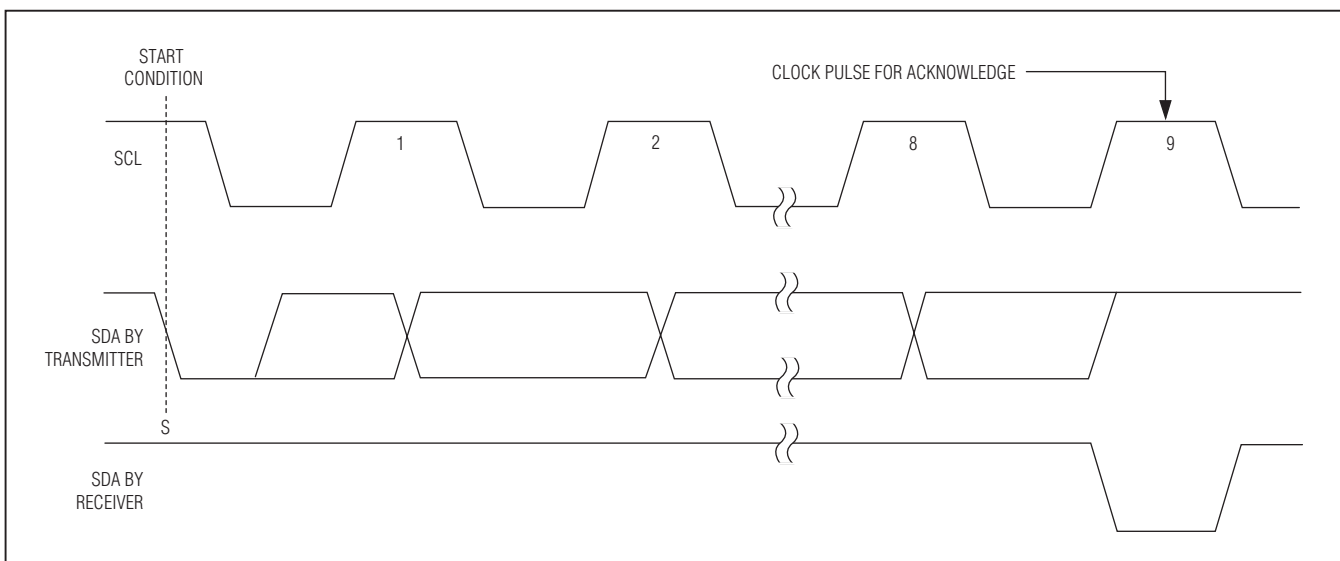

Figure 8. Acknowledge

0 to 16V, Hot-Swap Controller with 10-Bit Current, Voltage Monitor, and 4 LED Drivers

Table 54. Circular Buffer Readout Sequence

READ-OUT ORDER	1ST OUT	2ND OUT	...	48TH OUT	49TH OUT	50TH OUT
Chronological Number	1	2	...	48	49	0

The slave generates a NACK at step 5 if the command code is invalid. The command code must be in the 0x00 to 0x45 range. The internal address pointer returns to 0x00 after incrementing from the highest register address.

Receive Byte

The receive-byte protocol allows the master device to read the register content of the device (see Figure 7). The EEPROM or register address must be preset with a send-byte protocol first. Once the read is complete, the internal pointer increases by one. Repeating the receive byte protocol reads the contents of the next address. The receive-byte procedure follows:

- 1) The master sends a START condition.
- 2) The master sends the 7-bit slave address and a read bit (high).
- 3) The addressed slave asserts an ACK on SDA.
- 4) The slave sends 8 data bits.
- 5) The slave increments its internal address pointer.
- 6) The master asserts an ACK on SDA and repeats steps 4, 5 or asserts a NACK and generates a STOP condition.

The internal address pointer returns to 0x00 after incrementing from the highest register address.

Address Pointers

Use the send-byte protocol to set the register address pointers before read and write operations. For the configuration registers, valid address pointers range from 0x00 to 0x45, and the circular buffer addresses are 0x46 to 0x49. Register addresses outside this range result in a NACK being issued from the device.

Circular Buffer Read

The circular buffer read operation is similar to the receive-byte operation. The read operation is triggered after any one of the circular buffer base addresses is loaded. During a circular buffer read, although all is transparent from the external world, internally the autoincrement function in the I²C controller is disabled. Thus, it is possible to read one of the circular buffer blocks with a burst read without changing the virtual internal address corresponding to the base address. Once the master issues a NACK, the circular reading stops, and the default functions of the I²C slave bus controller are restored.

In 8-bit read mode, every I²C read operation shifts out a single sample from the circular buffer. In 10-bit mode, two subsequent I²C read operations shift out a single 10-bit sample from the circular buffer, with the high-order byte read first, followed by a byte containing the right-shifted 2 least-significant bits. Once the master issues a NACK, the read circular buffer operation terminates and normal I²C operation returns.

The data in the circular buffers is read back with the next-to-oldest sample first, followed by progressively more recent samples until the most recent sample is retrieved, followed finally by the oldest sample (see Table 54).

Chip Information

PROCESS: BiCMOS

Package Information

For the latest package outline information and land patterns, go to www.maxim-ic.com/packages. Note that a "+", "#", or "-" in the package code indicates RoHS status only. Package drawings may show a different suffix character, but the drawing pertains to the package regardless of RoHS status.

PACKAGE TYPE	PACKAGE CODE	OUTLINE NO.	LAND PATTERN NO.
32 TQFN-EP	T3255+4	21-0140	90-0012

0 to 16V, Hot-Swap Controller with 10-Bit Current, Voltage Monitor, and 4 LED Drivers

Revision History

REVISION NUMBER	REVISION DATE	DESCRIPTION	PAGES CHANGED
0	7/10	Initial release	—

Maxim cannot assume responsibility for use of any circuitry other than circuitry entirely embodied in a Maxim product. No circuit patent licenses are implied. Maxim reserves the right to change the circuitry and specifications without notice at any time.

38 _____ **Maxim Integrated Products, 120 San Gabriel Drive, Sunnyvale, CA 94086 408-737-7600**

Mouser Electronics

Authorized Distributor

Click to View Pricing, Inventory, Delivery & Lifecycle Information:

[Maxim Integrated:](#)

[MAX5978ETJ+](#) [MAX5978ETJ+T](#)