

LOC	DIST	REVISIONS					
		P	LTN	DESCRIPTION	DATE	DWN	APVD
ES	00	G9		ADD NEW DASH NUMBER 2-9	04MAY2012	CZ	SZ
		H2		REV PER ECR-12-020199	22NOV2012	CZ	SZ
		H4		ADDED THE NEW DASH NUMBER -33	28DEC2012	ML	SZ

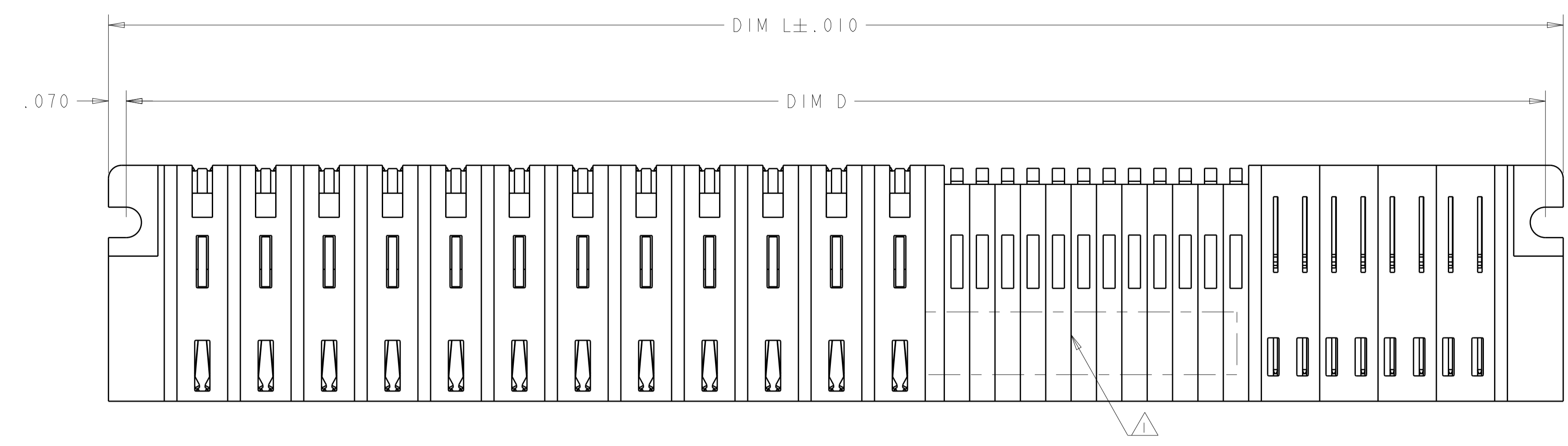

- 1 "AMP", PART NUMBER, AND DATECODE TO BE MARKED IN AREA SHOWN. PARTS UNDER 2.00 LONG MAY BE MARKED ON BOTH SIDES.
- 2 MATERIAL:  
HOUSING - GLASS FILLED HIGH TEMP THERMO PLASTIC, BLACK, UL94 V-0  
SIGNAL CONTACT - COPPER ALLOY  
POWER CONTACT - HIGH CONDUCTIVITY COPPER ALLOY.
- 3 CONTACT PLATING - NOBLE METAL PLATING ON CONTACT FUNCTIONAL AREA OF POWER AND SIGNAL CONTACTS
- 4 MECHANICAL CONNECTOR KEEP OUT ZONE.
- 5 DATUM AND BASIC DIMENSIONS ESTABLISHED BY CUSTOMER.
- 6 PCB - HOLE DIAMETERS ARE FINISHED HOLE SIZE.
- 7 PCB - .0453±.0010 DRILLED HOLES PLATED WITH .0003 MIN Sn OVER .001 TO .003 Cu PLATING TO ACHIEVE A .040 DIA HOLE.
- 8 TO GENERAL POWER CONTACT (WITHOUT LP POWER CONTACT), VARIABLE DIMENSIONS PLEASE SEE SHEET 2.
- 9 PLEASE REFER TO PAGE 5 FOR DETAIL DIMENSIONS.
- 10 PLEASE REFER TO PAGE 7 FOR SPECIAL DIMENSIONS.
- 11 FOR LP/S/P CONFIGURATION, OR SPECIAL DIMENSIONS FOR PART 2-6450840-1, PLEASE REFER TO SHEET 2.

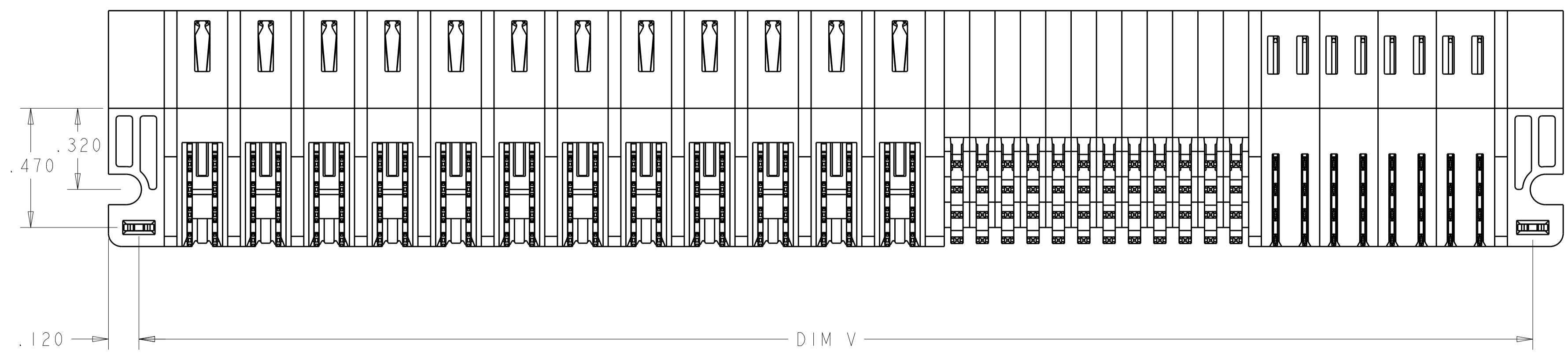
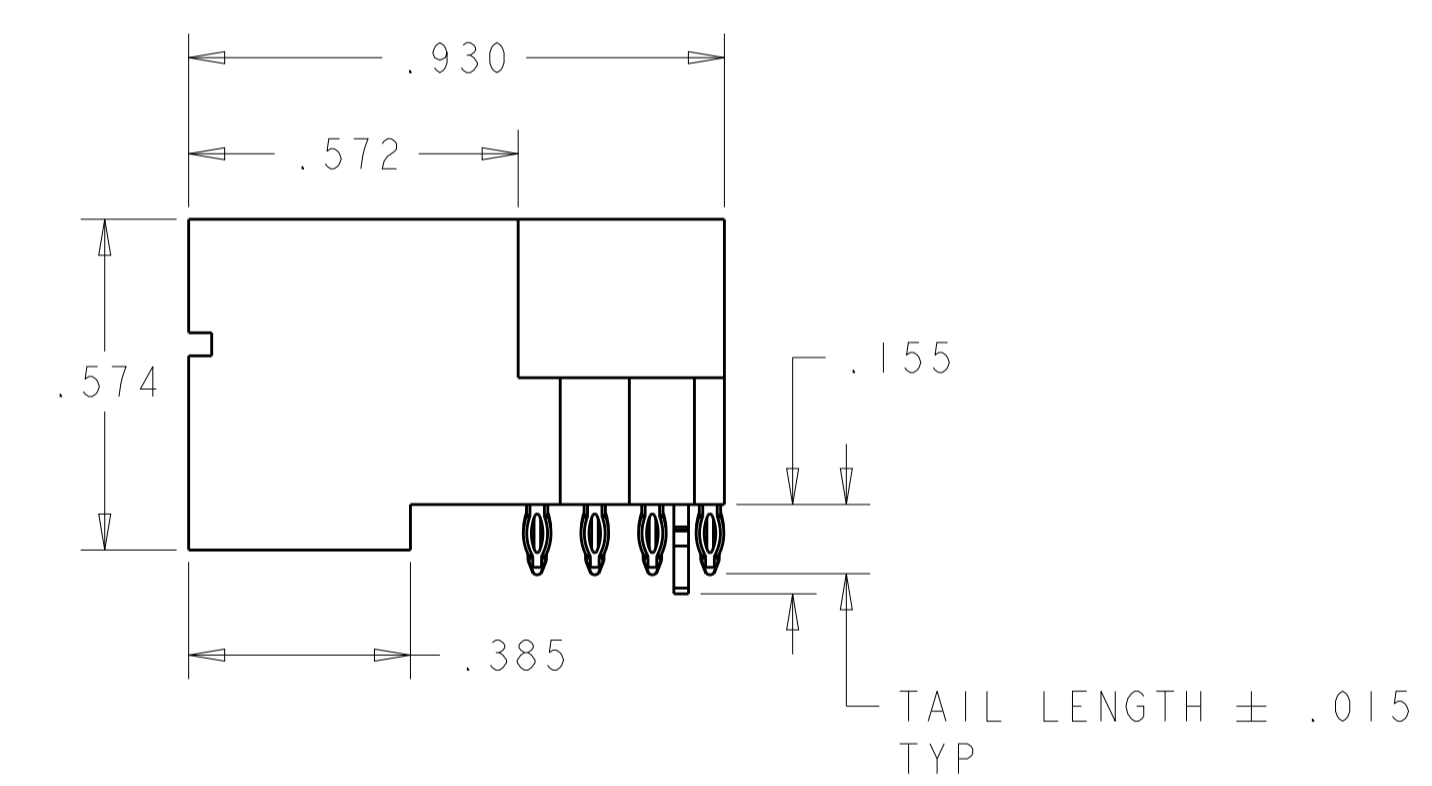
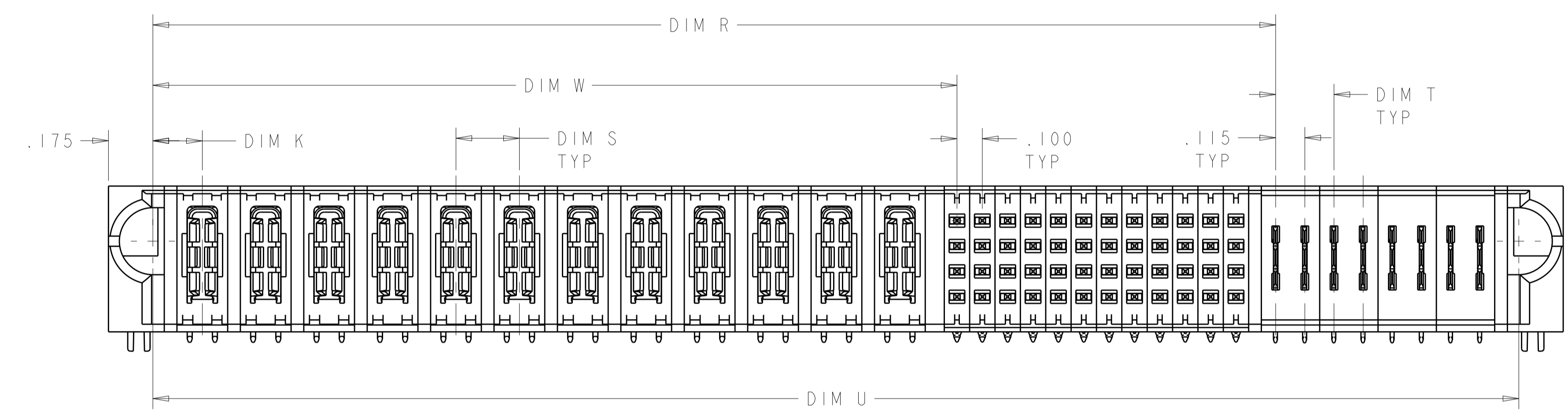

THIS DRAWING IS A CONTROLLED DOCUMENT.		DWN ALEX SHOAL CHK Sunny Zhao	14DEC2007 20DEC2007		NAME RIGHT ANGLE HEADER W/ LP CONTACT AND SHORT END MODULES MULTI-BEAM XLE	
DIMENSIONS: INCHES		TOLERANCES UNLESS OTHERWISE SPECIFIED:			PRODUCT SPEC	
		0 PLC ±	1 PLC ±.01	108-2292		SIZE A100779
MATERIAL		2 PLC ±.005	3 PLC ±.0050	APPLICATION SPEC		CAGE CODE DRAWING NO C=6450840
FINISH		4 PLC ±.0050	ANGLES ±.7°	114-13251		RESTRICTED TO
: 2		: 3		WEIGHT		SCALE 4:1 SHEET 1 OF 16 REV H4
Customer Drawing				Customer Drawing		

THIS DRAWING IS UNPUBLISHED. RELEASED FOR PUBLICATION 20  
 © COPYRIGHT 20 BY TE CONNECTIVITY ALL RIGHTS RESERVED.

LOC	DIST	REVISIONS					
		P	LTN	DESCRIPTION	DATE	DWN	APVD
ES	00	-		SEE SHEET 1	-	-	-

H3	.250	2.315	1.535	.860	2.205	.230	2.415	2.555	.1275	6LP + 24S + 3P	3-6450840-3
H2	-	1.135	.8075	.375	1.025	-	1.235	1.375	.1025	2LP + 16S + 2LP	3-6450840-1
	.250	2.300	1.520	.845	2.190	.250	2.400	2.540	.170	3P + 24S + 3P	2-6450840-9
	.250	3.800	2.270	1.595	3.690	.250	3.900	4.040	.170	6P + 24S + 6P	2-6450840-7
	.250	4.400	2.370	2.095	4.290	.250	4.500	4.640	.170	8P + 8S + 8P	1-6450840-6
	.250	1.700	1.145	.645	1.590	.250	1.800	1.940	.195	2P + 16S + 2P	2-6450840-5
	.250	6.000	3.970	2.095	5.890	.250	6.100	6.240	.170	8P + 72S + 8P	2-6450840-3
	.250	2.500	1.470	1.095	2.390	.250	2.600	2.740	.170	4P + 12S + 4P	2-6450840-2
	.230	5.585	1.5025	.645	5.475	.250	5.685	5.825	.170	2P + 32S + 4LP + 14P	2-6450840-1
	.250	3.520	2.990	2.265	3.410	.230	3.620	3.760	.1525	18LP + 24S + 2P	2-6450840-0
	-	1.300	1.020	.345	1.190	-	1.400	1.540	.170	1P + 24S + 1P	1-6450840-5
	.200	3.300	2.020	1.345	3.190	.200	3.400	3.540	.170	6HDP + 24S + 6HDP	1-6450840-2
	.200	2.400	1.520	.945	2.290	.200	2.500	2.640	.170	4HDP + 20S + 4HDP	1-6450840-1
	.250	2.400	1.370	1.095	2.290	.250	2.500	2.640	.170	4P + 8S + 4P	1-6450840-0
	.200	2.100	1.220	.945	1.990	.200	2.200	2.340	.170	4HDP + 8S + 4HDP	6450840-9
	-	-	-	-	-	-	-	-	-	4P+16S+24S+2HDP	6450840-8
	-	1.300	1.020	.345	1.190	-	1.400	1.540	.170	1P + 24S + 1P	6450840-7
	-	2.480	2.1525	1.345	2.370	.250	2.580	2.720	.170	5P + 32S + 2LP	6450840-6
	.250	3.400	2.120	1.395	3.290	.250	3.500	3.640	.170	5P + 24S + 5P	6450840-5
	.200	5.150	2.670	1.345	5.040	.300	5.250	5.390	.195	4ACP + 48S + 12HDP	6450840-4
	.230	5.495	4.4275	3.170	5.385	.250	5.595	5.735	.195	12P + 48S + 8LP	6450840-3
	-	2.315	-	-	2.205	-	2.415	2.555	.170	3P+ 1LP + 24S + 3HDP	6450840-2
	DIM T	DIM V	DIM R	DIM W	DIM U	DIM S	DIM D	DIM L	DIM K	DESCRIPTION	PART NUMBER

THIS DRAWING IS A CONTROLLED DOCUMENT.		DWN ALEX SHOAL CHK Sunny Zhao	14DEC2007 20DEC2007	 TE Connectivity NAME RIGHT ANGLE HEADER W/ LP CONTACT AND SHORT END MODULES MULTI-BEAM XLE
DIMENSIONS: INCHES		TOLERANCES UNLESS OTHERWISE SPECIFIED:	PRODUCT SPEC 108-2292 APPLICATION SPEC 114-13251	
0 PLC ±. 1 PLC ±.01 2 PLC ±.01 3 PLC ±.005 4 PLC ±.0050 ANGLES ±.0°		APVD Sunny Zhao	SIZE A100779	RESTRICTED TO
MATERIAL		FINISH	WEIGHT	SCALE 1:1 SHEET 2 OF 16 REV H4
		Customer Drawing		

LOC	DIST	REVISIONS					
		P.	LTN	DESCRIPTION	DATE	DMN	APVD
ES	00	-	-	SEE SHEET 1	-	-	-

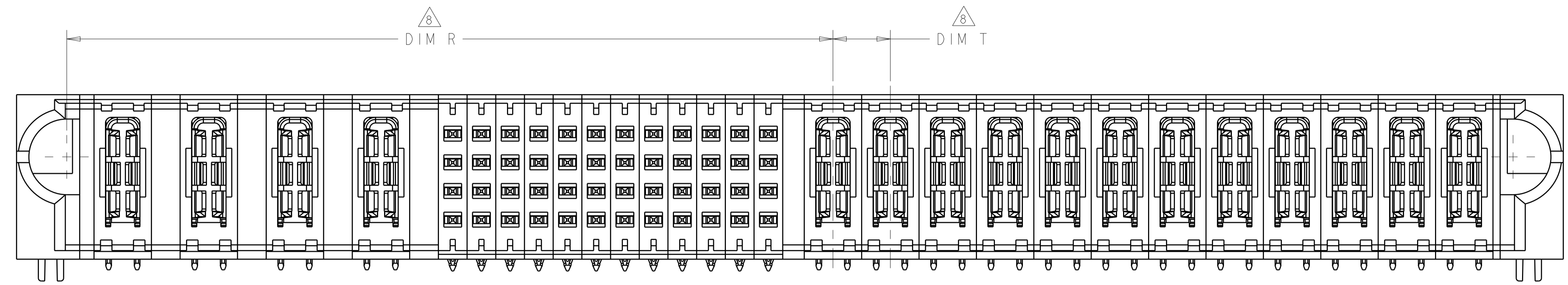

FOR P/S/P CONFIGURATION  
 UNSPECIFIED DIM REFER TO SHEET 1  
 SCALE 4:1

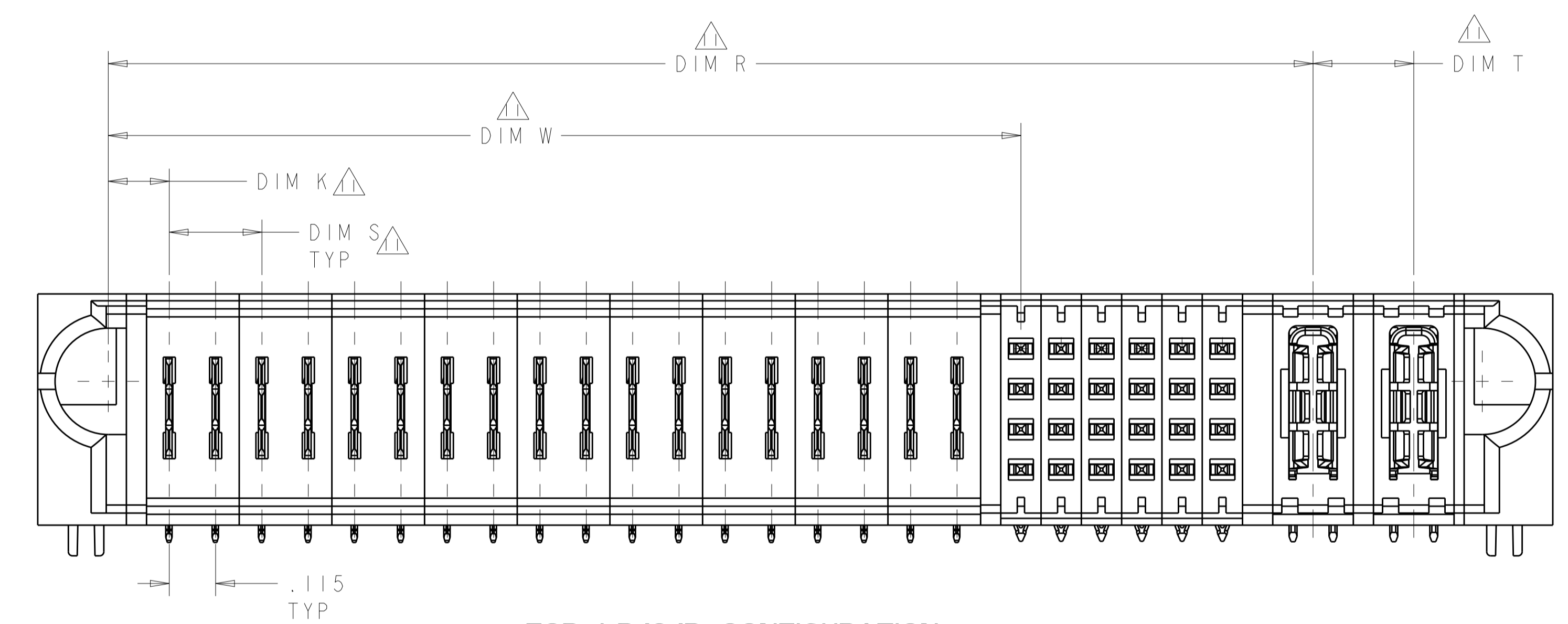

FOR LP/S/P CONFIGURATION  
 UNSPECIFIED DIM REFER TO SHEET 1

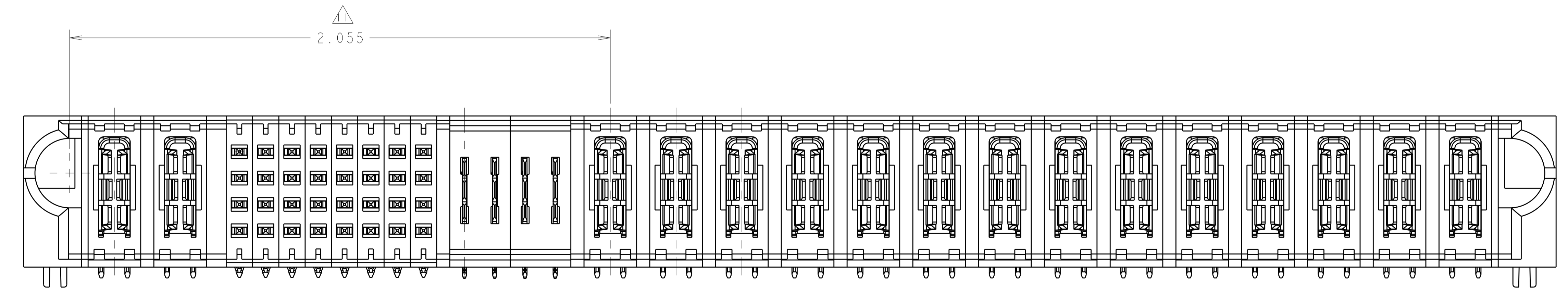

FOR PART 2-6450840-1 ONLY

THIS DRAWING IS A CONTROLLED DOCUMENT.		OWN: ALEX SHOAL 14DEC2007	 TE Connectivity NAME: RIGHT ANGLE HEADER W/ LP CONTACT AND SHORT END MODULES MULTI-BEAM XLE
DIMENSIONS: INCHES		CHK: Sunny Zhao 20DEC2007	
TOLERANCES UNLESS OTHERWISE SPECIFIED:		APVD: Sunny Zhao 20DEC2007	
0 PLC ±. 1 PLC ±.01 2 PLC ±.01 3 PLC ±.005 4 PLC ±.0050 ANGLES ±.0°		PRODUCT SPEC: 108-2292 APPLICATION SPEC: 114-13251 WEIGHT: - FINISH: -	
MATERIAL: -		SIZE: A100779	CAGE CODE: C=6450840 CUSTOMER DRAWING: - SCALE: 1:1 SHEET: 3 OF 16 REV: H4



LOC	DIST	REVISIONS			
P	LTN	DESCRIPTION	DATE	OWN	APVD
ES	00	SEE SHEET 1			

PART NUMBER	ROWS	POWER					SIGNAL						POWER				
		P1	P2	P3	P4	P5	1	2	3	4	5	6	P6	P7	P8	P9	P10
6450840-5	D						Z5	Z5	Z5	Z5	Z5	Z5					
	C						Y5	Y5	Y5	Y5	Y5	Y5					
	B	TT	TT	TT	TT	TT	R5	R5	R5	R5	R5	R5	TT	TT	TT	TT	TT
	A						O5	O5	O5	O5	O5	O5					
5P + 24S + 5P																	

PART NUMBER	ROWS	POWER					SIGNAL								POWER	
		P1	P2	P3	P4	P5	1	2	3	4	5	6	7	8	LP1	LP2
6450840-6	D						Z5	Z5	Z5	Z5	Z5	Z5	Z5	Z5	Z1	
	C						Y5	Y5	Y5	Y5	Y5	Y5	Y5	Y5		
	B	TT	TT	TT	TT	TT	R5	R5	R5	R5	R5	R5	R5		LT	
	A	HD					O5	O5	O5	O5	O5	O5	O5		HD	
5P + 32S + 2LP																

NO CONTACT LOADED

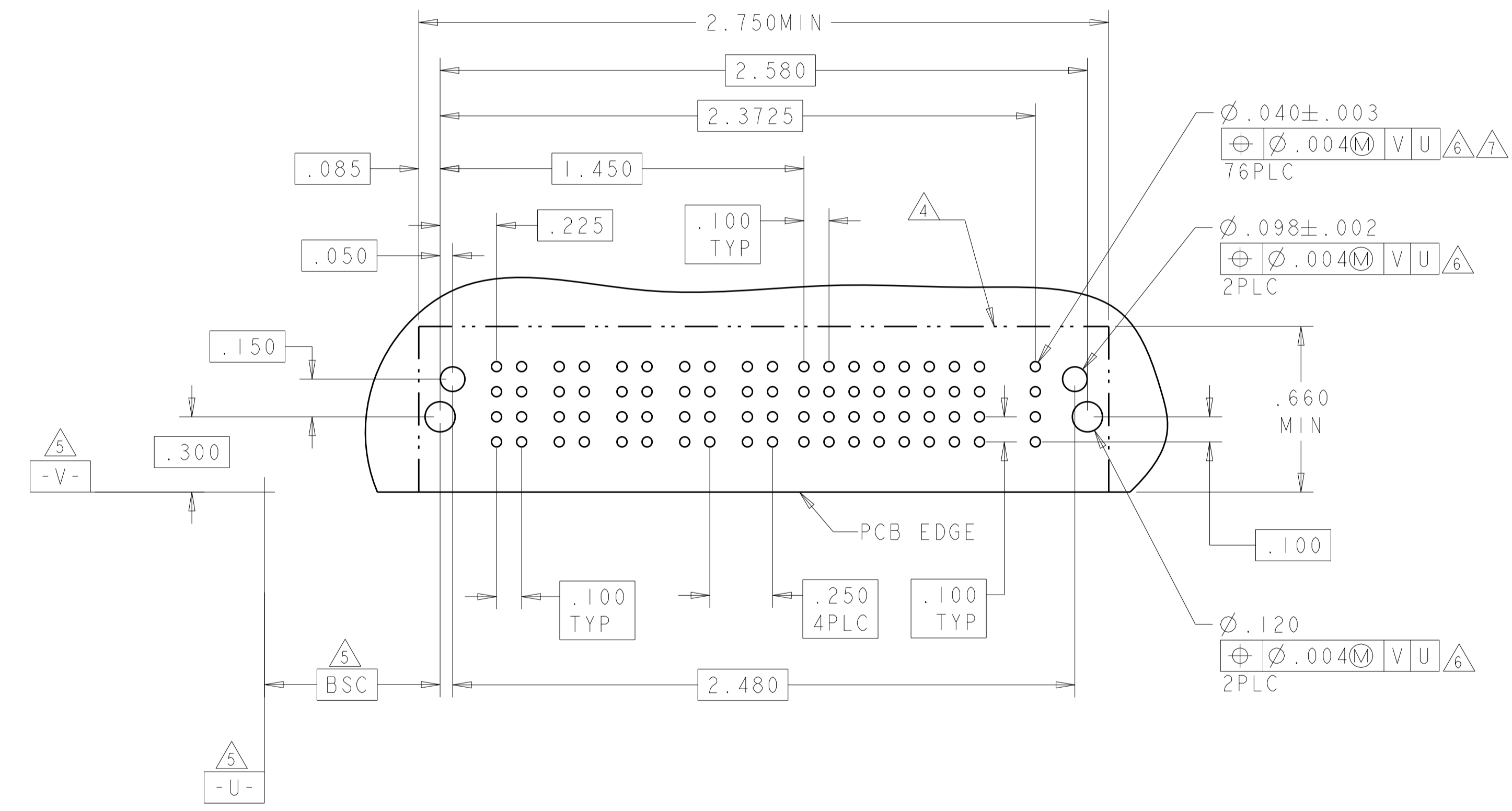
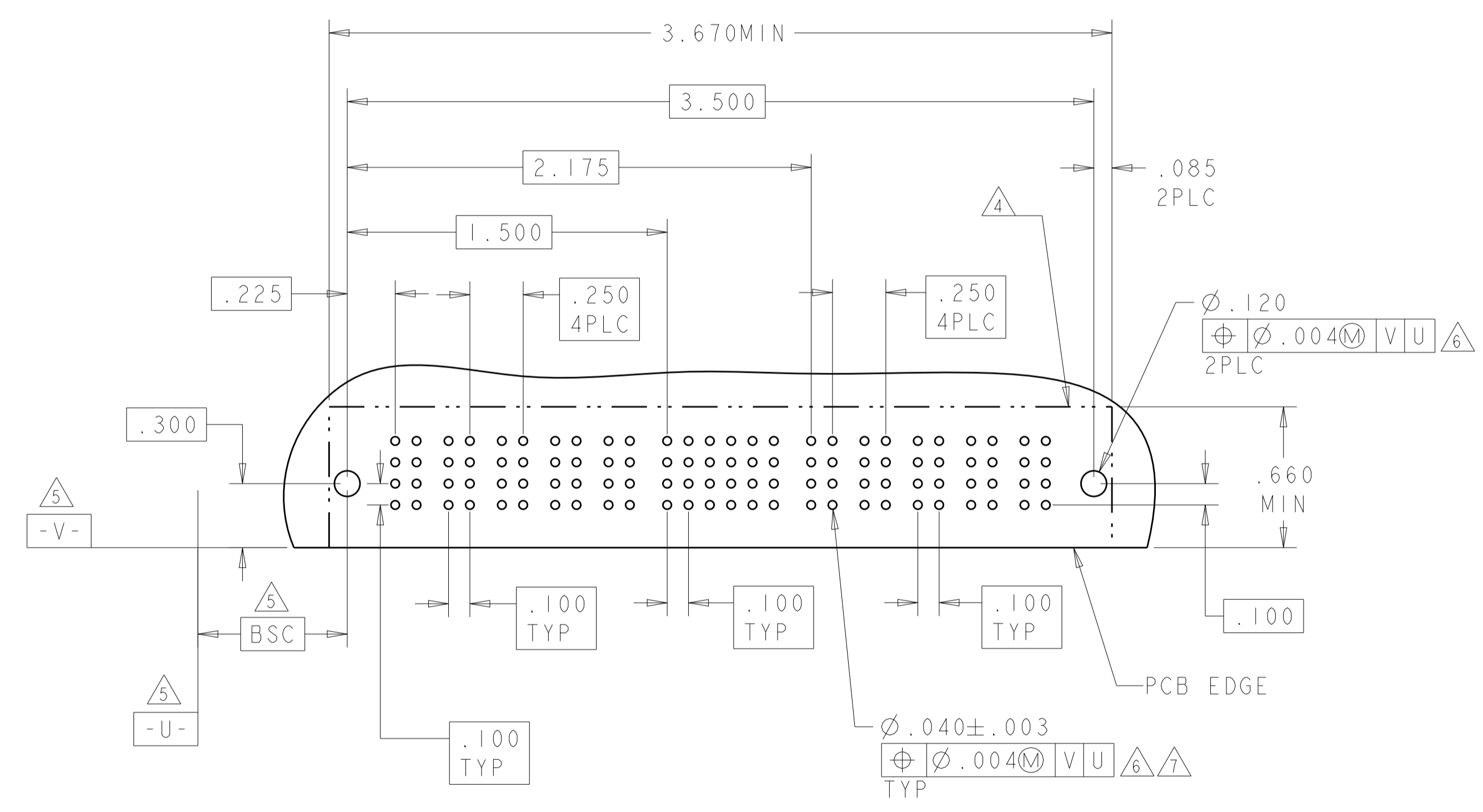

THIS DRAWING IS A CONTROLLED DOCUMENT.

DIMENSIONS: INCHES	TOLERANCES UNLESS OTHERWISE SPECIFIED: 0 PLC ±. 2 PLC ±.01 3 PLC ±.005 4 PLC ±.0050 ANGLES ±.7°	OWN: ALEX SHOAL 14DEC2007 CHK: Sunny Zhao 20DEC2007 APVD: Sunny Zhao 20DEC2007	NAME: RIGHT ANGLE HEADER W/ LP CONTACT AND SHORT END MODULES MULTI-BEAM XLE
MATERIAL: -	FINISH: -	PRODUCT SPEC: 108-2292 APPLICATION SPEC: 114-13251 WEIGHT: -	SIZE: A1 CAGE CODE: 00779 DRAWING NO: 6450840
Customer Drawing		SCALE: 1:1	SHEET 5 OF 16 REV: H4

4805 (3/11)

LOC	DIST	REV	DATE	APPD
ES	00			

REVISIONS		DATE	OWN	APPD
P	LTM			
- SEE SHEET 1				

PART NUMBER	ROWS	POWER	SIGNAL						POWER		
			P1	1	2	3	4	5		6	P2
6450840-7	D C B A	TT	HD	Z5	Z5	Z5	Z5	Z5	Z5	TT	HD
				Y5	Y5	Y5	Y5	Y5	Y5		
				R5	R5	R5	R1	R5	R5		
				O5	O5	O5	O5	O5	O5		
IP + 24S + IP											

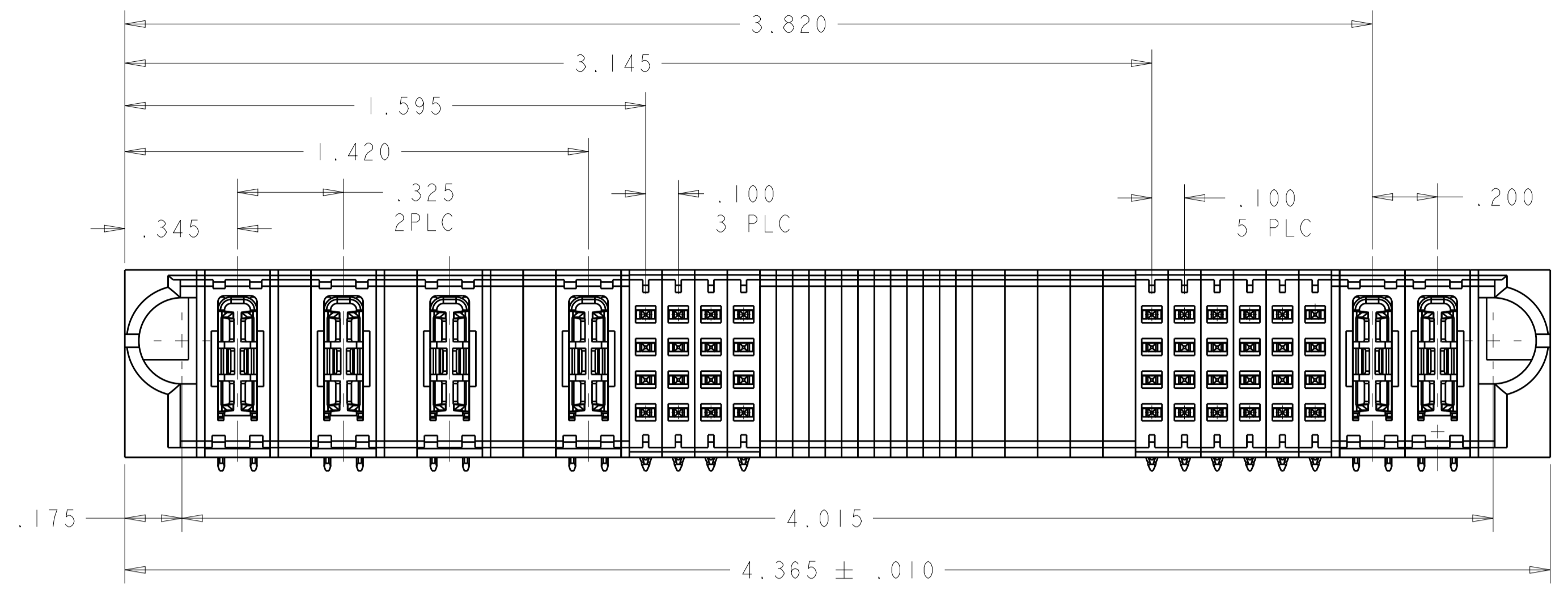

PART NUMBER: 6450840-8

PART NUMBER	ROWS	POWER				SIGNAL				BLANK	SIGNAL				POWER		
		P1	P2	P3	P4	1	2	3	4		5	6	7	8	9	10	P5
6450840-8	D C B A	TT	TT	TT	TT	Z5	Z5	Z5	Z5	BLANK	Z5	Z5	Z5	Z5	TT	TT	
						Y5	Y5	Y5	Y5		Y5	Y5					
						R5	R5	R5	R5		R5	R5					
						O5	O5	O5	O5		O5	O5					
4P + 16S + 24S + 2HDP																	

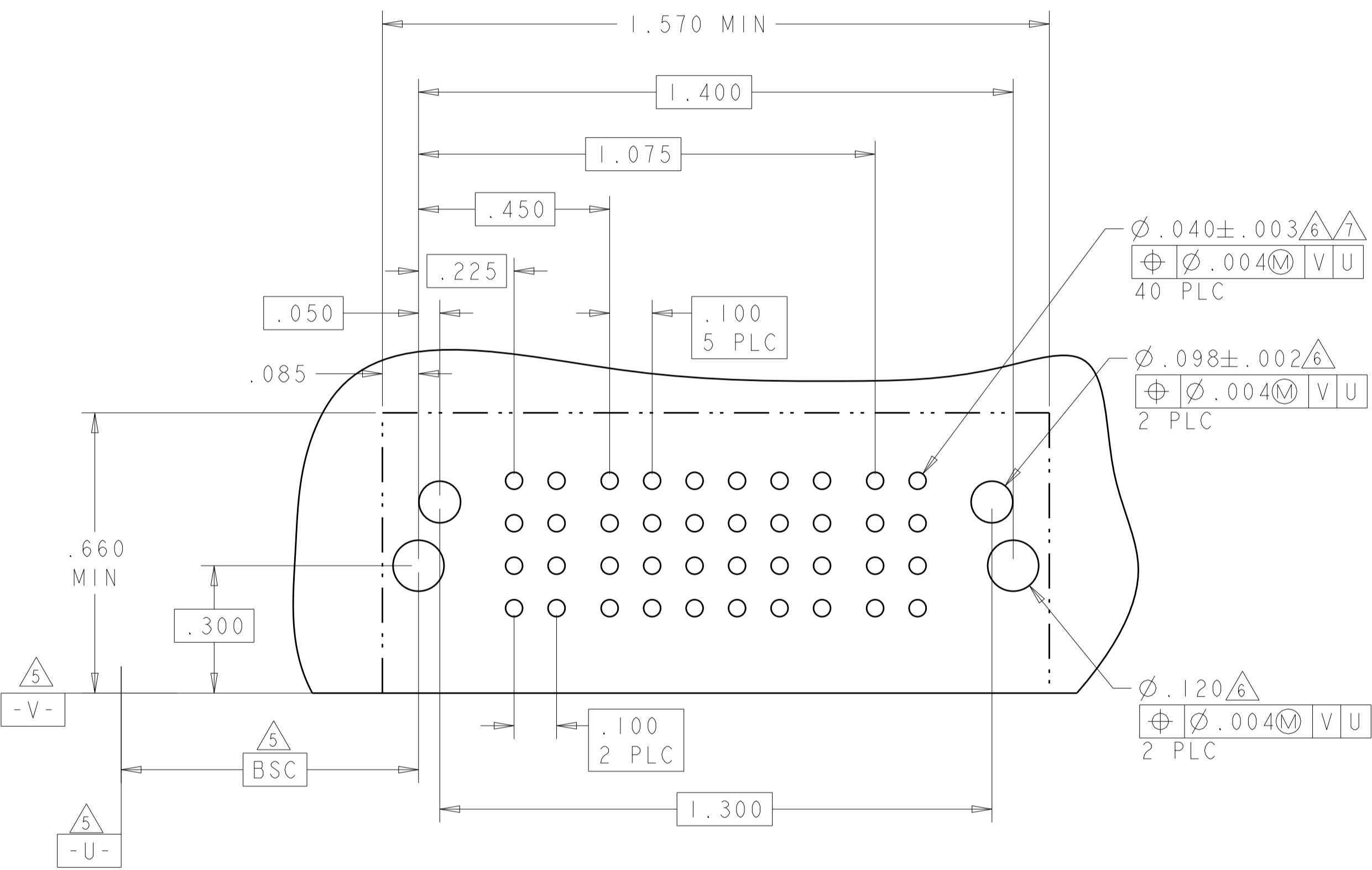

PART NUMBER	ROWS	POWER	SIGNAL						POWER		
			P1	1	2	3	4	5		6	P2
1-6450840-5	D C B A	TT	HD	Z5	Z5	Z5	Z5	Z5	Z5	TT	HD
				Y5	Y5	Y5	Y5	Y5	Y5		
				R5	R5	R5	R5	R5	R5		
				O5	O5	O1	O5	O5	O5		
IP + 24S + IP											

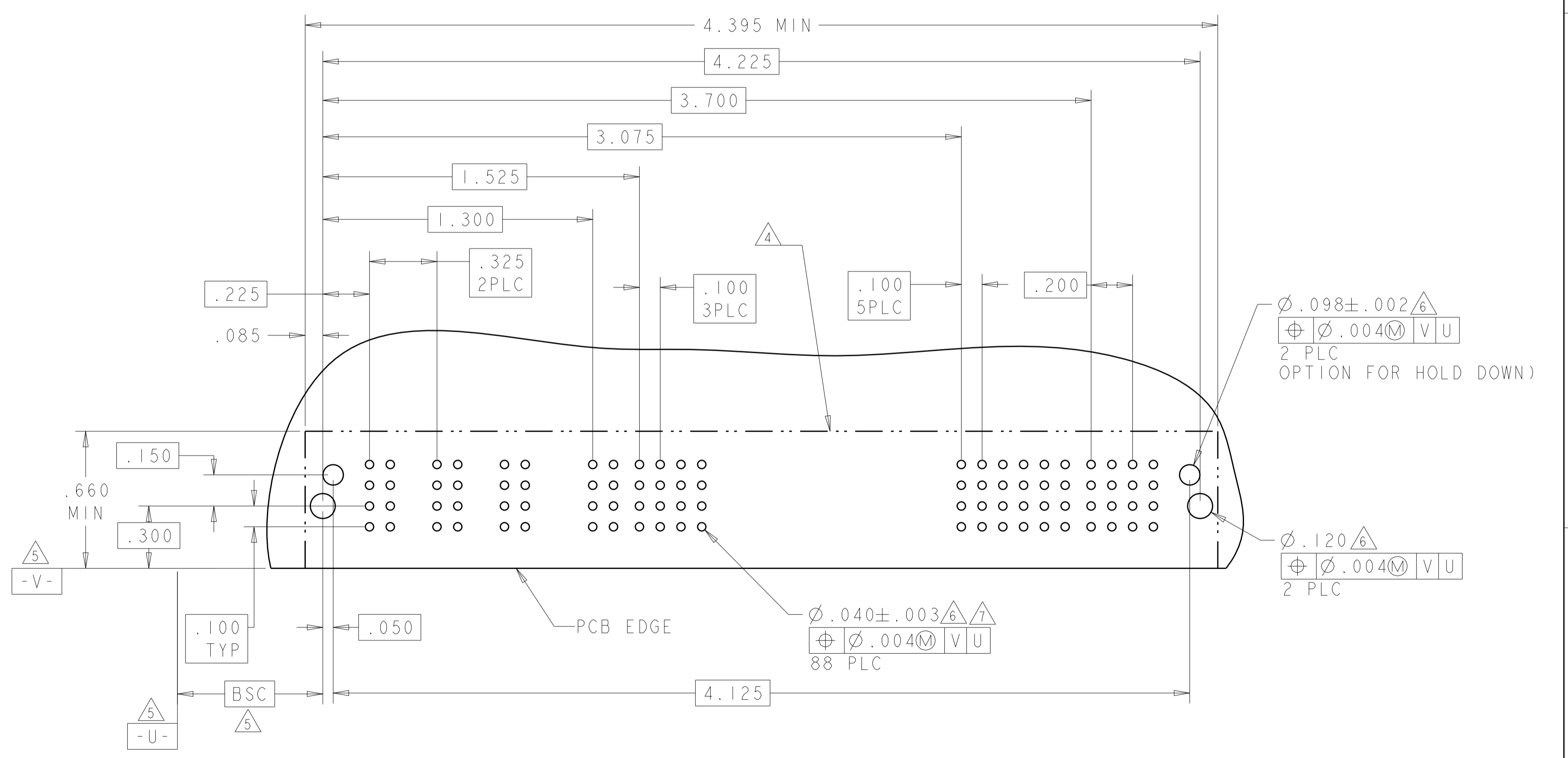

LAYOUT OF 1-6450840-5 IS SAME AS 6450840-7.

THIS DRAWING IS A CONTROLLED DOCUMENT.		OWN: ALEX SHOAL 14DEC2007	TE Connectivity
DIMENSIONS: INCHES		CHK: Sunny Zhao 20DEC2007	
TOLERANCES UNLESS OTHERWISE SPECIFIED:		APVD: Sunny Zhao 20DEC2007	NAME: RIGHT ANGLE HEADER W/ LP CONTACT AND SHORT END MODULES MULTI-BEAM XLE
0 PLC ±. 1 PLC ±.01 2 PLC ±.01 3 PLC ±.005 4 PLC ±.005 ANGLES ±.0050		PRODUCT SPEC: 108-2292	SIZE: A1
MATERIAL: FINISH:		APPLICATION SPEC: 114-13251	CAGE CODE: 6450840
		WEIGHT: Customer Drawing	RESTRICTED TO: H4
		SCALE: 1:1	SHEET 6 OF 16

LOC	DIST	REV	DATE	APPD
ES	00			
		REVISIONS		
		DESCRIPTION	DATE	APPD
		SEE SHEET 1		

PART NUMBER	ROWS	POWER				SIGNAL	POWER					
		P1	P2	P3	P4	1   2	P5	P6	P7	P8		
6450840-9	D C B A	HD	TT	TT	TT	TT	Z5	Z5	TT	TT	TT	TT
							Y5	Y5				
							R5	R5				
							O5	O5				
4HDP + 8S + 4HDP												

PART NUMBER	ROWS	POWER				SIGNAL	POWER					
		P1	P2	P3	P4	1   2	P5	P6	P7	P8		
1-6450840-0	D C B A	HD	TT	TT	TT	TT	Z5	Z5	TT	TT	TT	TT
							Y5	Y5				
							R5	R5				
							O5	O5				
4P + 8S + 4P												

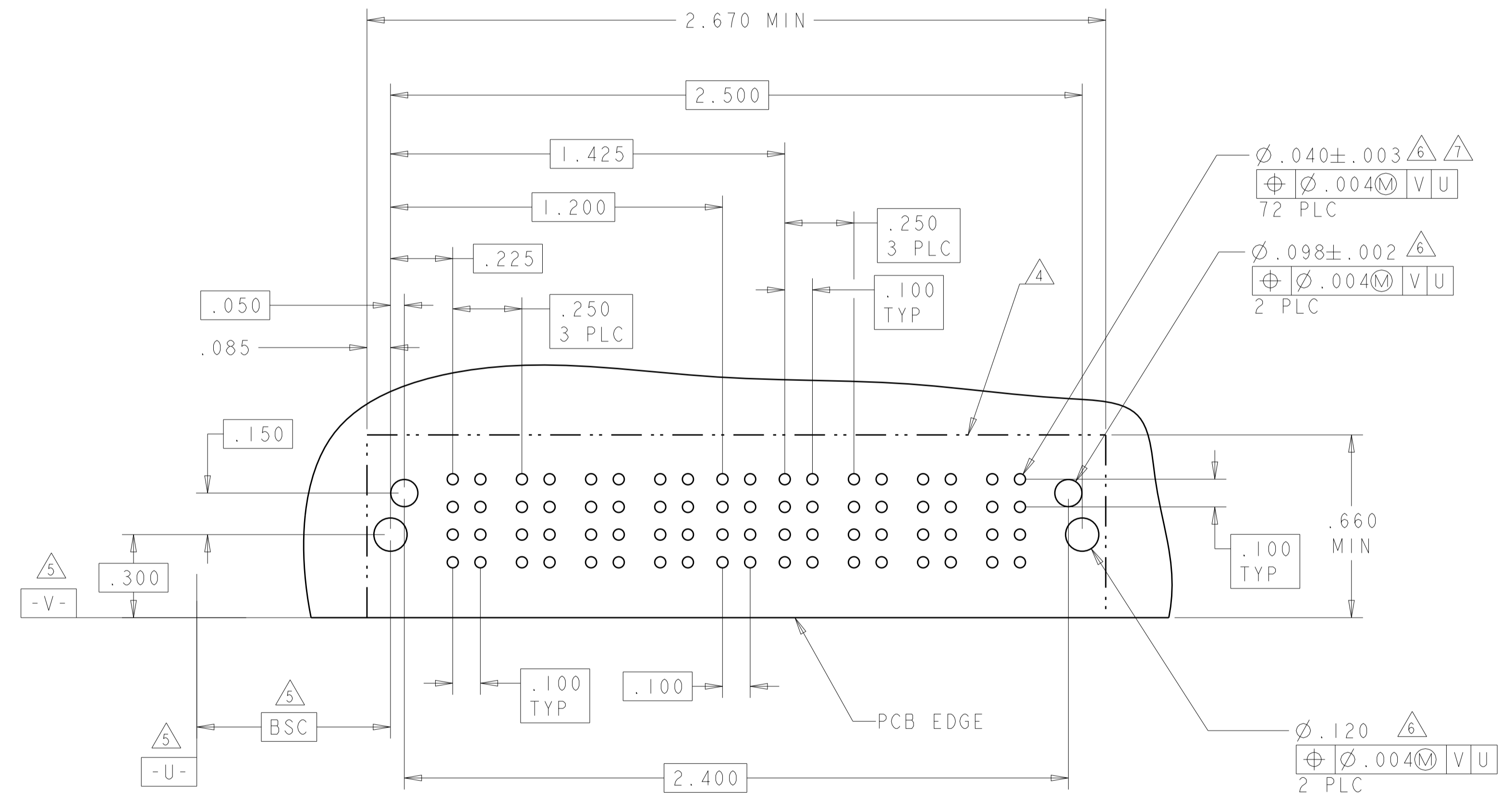
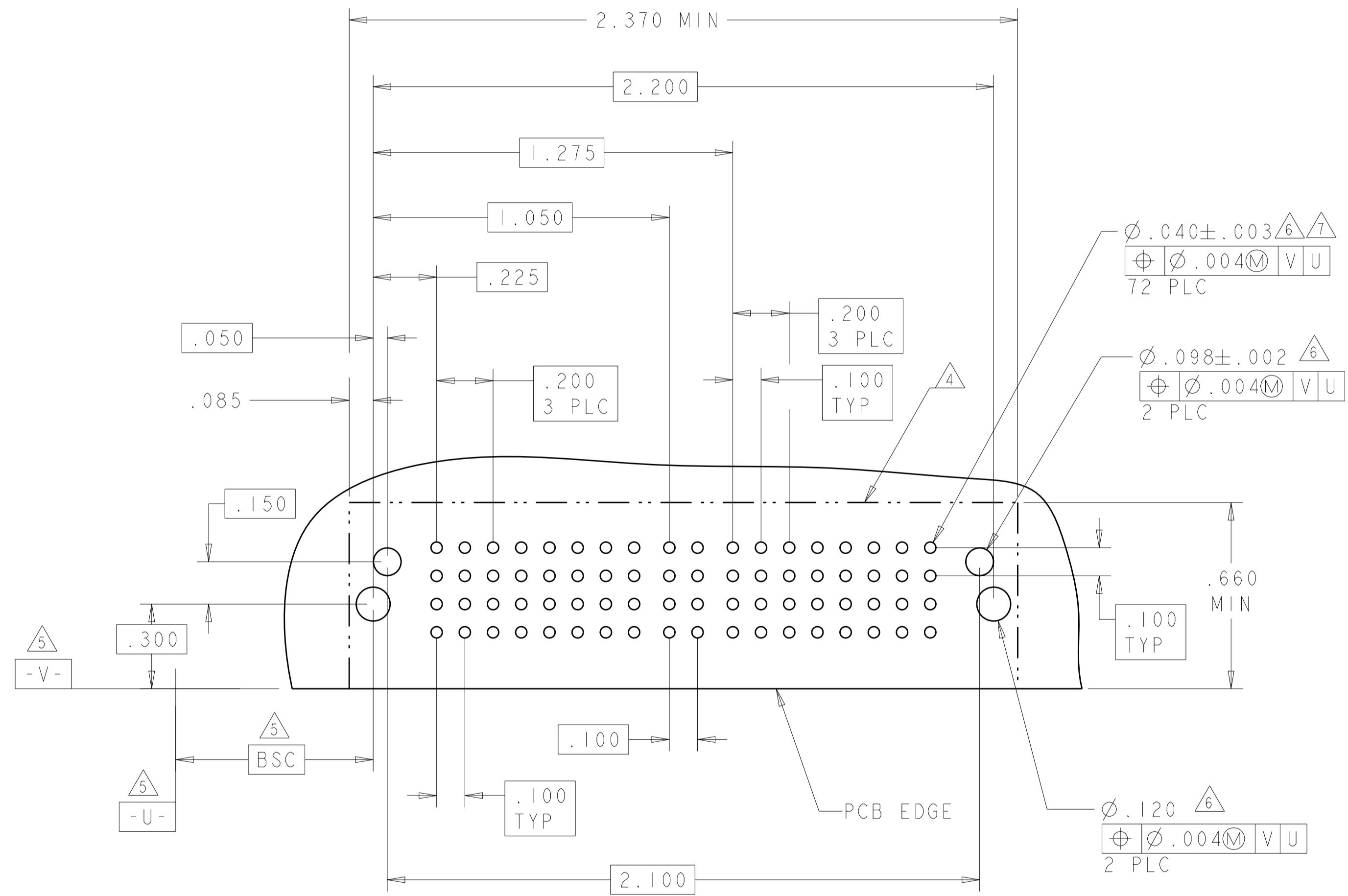

THIS DRAWING IS A CONTROLLED DOCUMENT.

DIMENSIONS: INCHES	TOLERANCES UNLESS OTHERWISE SPECIFIED: 0 PLC ±. 1 PLC ±.01 2 PLC ±.01 3 PLC ±.005 4 PLC ±.0050 ANGLES ±.7°	FINISH	FINISH
-----------------------	--	--------	--------

OWN: ALEX SHOAL 14DEC2007	CHK: Sunny Zhao 20DEC2007	APVD: Sunny Zhao 20DEC2007
PRODUCT SPEC: 108-2292	APPLICATION SPEC: 114-13251	WEIGHT: -
Customer Drawing		

**STE** TE Connectivity

NAME: RIGHT ANGLE HEADER W/ LP CONTACT AND SHORT END MODULES MULTI-BEAM XLE

SIZE: A1 00779 C=6450840

SCALE: 1:1 SHEET 7 OF 16 REV: H4





LOC	DIST	REVISIONS					
		P	LTN	DESCRIPTION	DATE	OWN	APVD
ES	00	-	-	SEE SHEET 1	-	-	-

PART NUMBER	ROWS	POWER						SIGNAL						POWER											
		P1	P2	P3	P4	P5	P6	1	2	3	4	5	6	P7	P8	P9	P10	P11	P12						
1-6450840-2	D	TT	TT	TT	TT	TT	TT	Z5	Z5	Z5	Z5	Z5	Z5	TT	TT	TT	TT	TT	TT						
	Y5							Y5	Y5	Y5	Y5	Y5													
	R5							R5	R5	R5	R5	R5													
	O5							O5	O5	O5	O5	O5													
6HDP + 24S + 6HDP																									

PART NUMBER	ROWS	LOW POWER																SIGNAL						POWER					
		LP1	LP2	LP3	LP4	LP5	LP6	LP7	LP8	LP9	LP10	LP11	LP12	LP13	LP14	LP15	LP16	LP17	LP18	1	2	3	4	5	6	P1	P2		
2-6450840-0	D	LT	LT	LT	LT	LT	LT	LT	LT	LT	LT	LT	LT	LT	LT	LT	LT	LT	LT	Z5	Z5	Z5	Z5	Z5	Z5	TT	TT		
	Y5																			Y5	Y5	Y5	Y5	Y5					
	R5																			R5	R5	R5	R5	R5					
	O5																			O5	O5	O5	O5	O5					
18LP + 24S + 2P																													

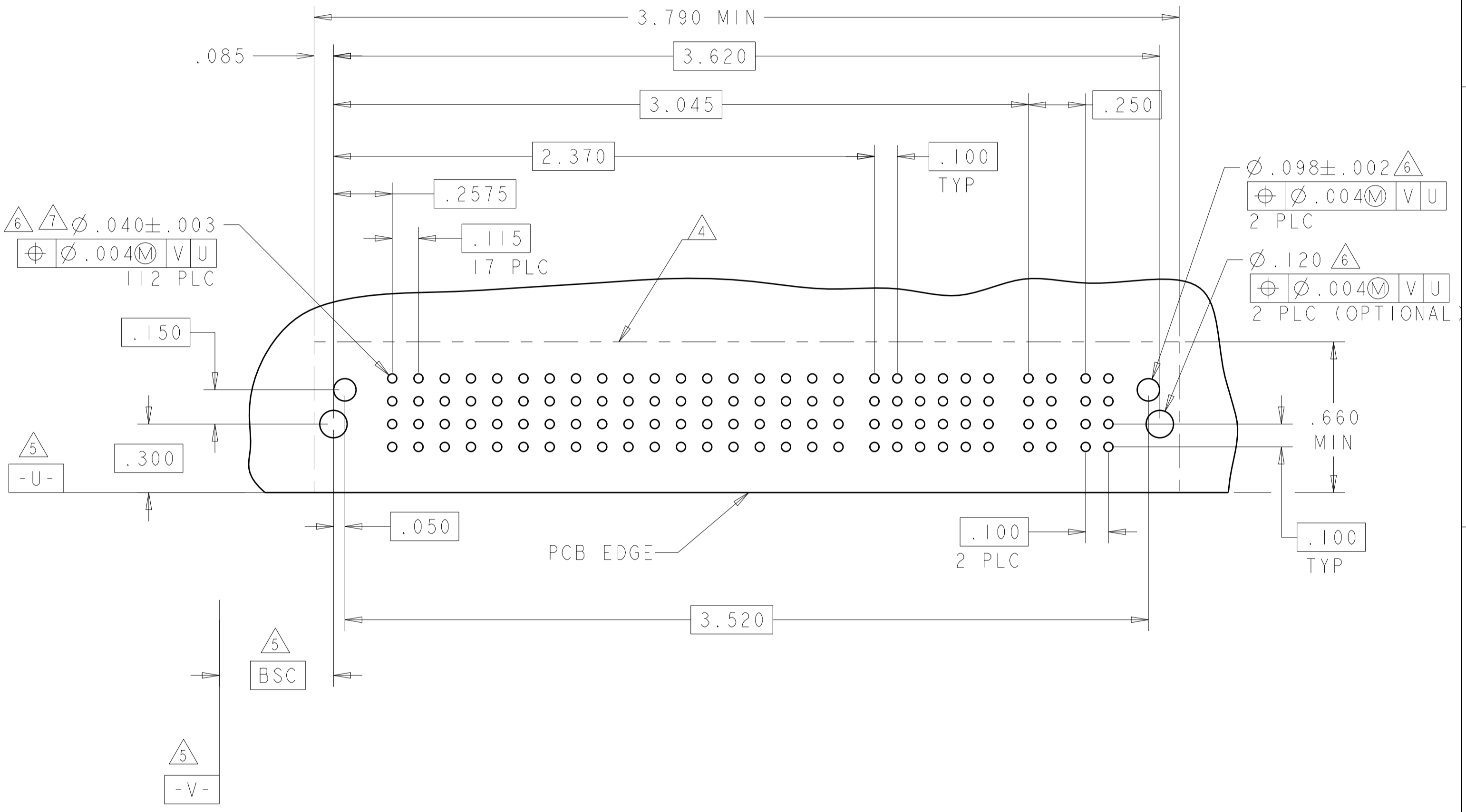
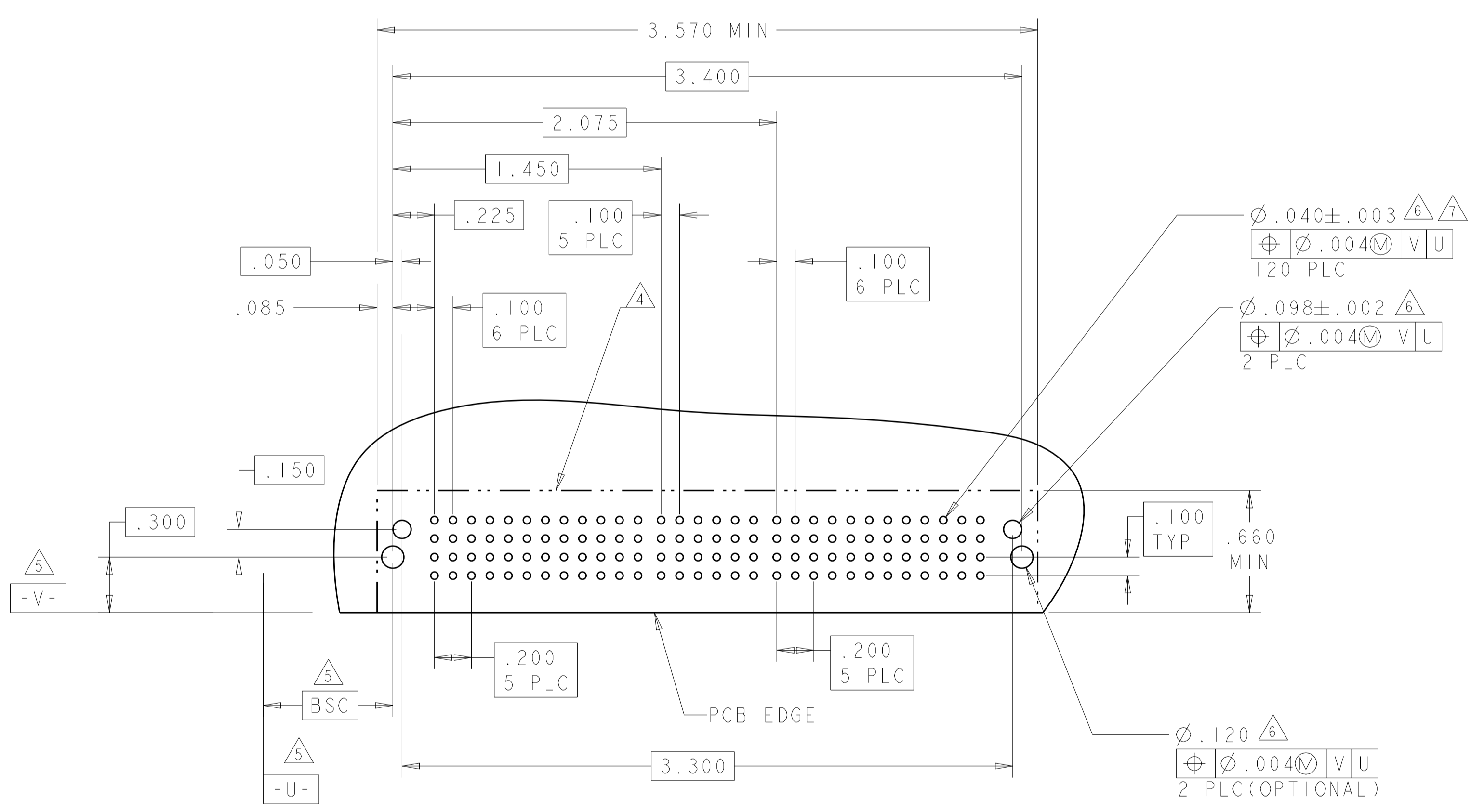

THIS DRAWING IS A CONTROLLED DOCUMENT. OWN: ALEX SHOAL 14DEC2007  
 CHK: Sunny Zhao 20DEC2007  
 APVD: Sunny Zhao 20DEC2007

**TE** Connectivity

NAME: RIGHT ANGLE HEADER W/ LP CONTACT AND SHORT END MODULES MULTI-BEAM XLE

PRODUCT SPEC: 108-2292  
 APPLICATION SPEC: 114-13251  
 WEIGHT: -

Customer Drawing

SCALE: 1:1 SHEET 9 OF 16 REV: H4

LOC	DIST	REVISIONS					
		P	LTN	DESCRIPTION	DATE	DMN	APVD
ES	00	-	-	SEE SHEET 1	-	-	-

PART NUMBER	ROWS	POWER								SIGNAL		POWER							
		P1	P2	P3	P4	P5	P6	P7	P8	1	2	P9	P10	P11	P12	P13	P14	P15	P16
1-6450840-6	D C B A	TT	TT	TT	TT	TT	TT	TT	TT	Z5	Z5	TT	TT	TT	TT	TT	TT	TT	TT
										Y5	Y5								
										R5	R5								
8P + 8S + 8P																			

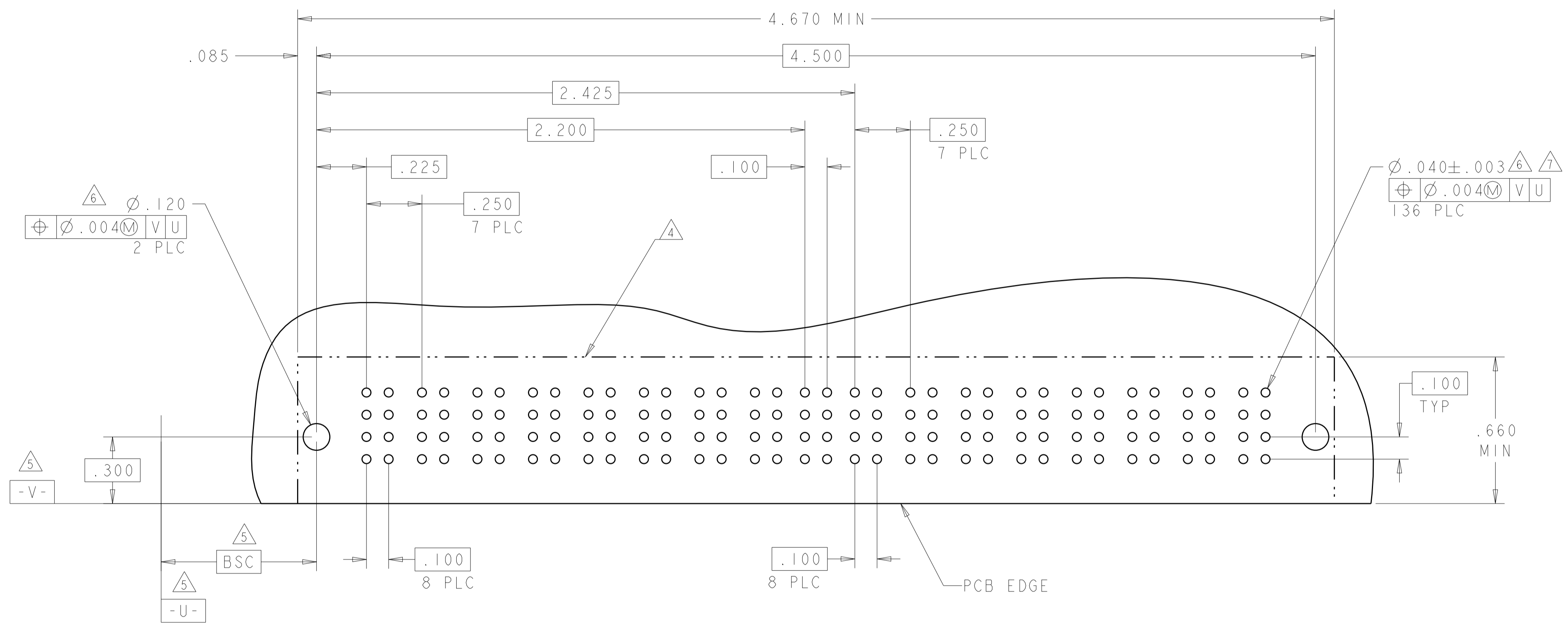

THIS DRAWING IS A CONTROLLED DOCUMENT.		DMN	ALEX SHOAL	14DEC2007	
DIMENSIONS: INCHES		CHK	Sunny Zhao	20DEC2007	
TOLERANCES UNLESS OTHERWISE SPECIFIED:		APVD	Sunny Zhao	20DEC2007	NAME
0 PLC	±	PRODUCT SPEC		RIGHT ANGLE HEADER	
1 PLC	±.01	APPLICATION SPEC		W/ LP CONTACT AND SHORT END MODULES	
2 PLC	±.005	SIZE		MULTI-BEAM XLE	
3 PLC	±.0050	CAGE CODE		DRAWING NO	
4 PLC	±.0050	WEIGHT		A100779C=6450840	
ANGLES	±.7°	MATERIAL		RESTRICTED TO	
FINISH	-	Customer Drawing		SCALE	1:1
				SHEET	10 OF 16
				REV	H4

LOC	DIST	REVISIONS					
		P	LTN	DESCRIPTION	DATE	OWN	APVD
ES	00	-	-	SEE SHEET 1	-	-	-

PART NUMBER	ROWS	POWER		SIGNAL								LOW POWER				POWER															
		P1	P2	1	2	3	4	5	6	7	8	LP1	LP2	LP3	LP4	P3	P4	P5	P6	P7	P8	P9	P10	P11	P12	P13	P14	P15	P16		
2-6450840-1	D	TT	TT	Z5	Z5	Z5	Z5	Z5	Z5	Z5	Z5																				
	C			Y5	Y5	Y5	Y5	Y5	Y5	Y5	Y5																				
	B			R5	R5	R5	R5	R5	R5	R5	R5																				
	A			O5	O5	O5	O5	O5	O5	O5	O5																				

2P + 32S + 4LP + 14P

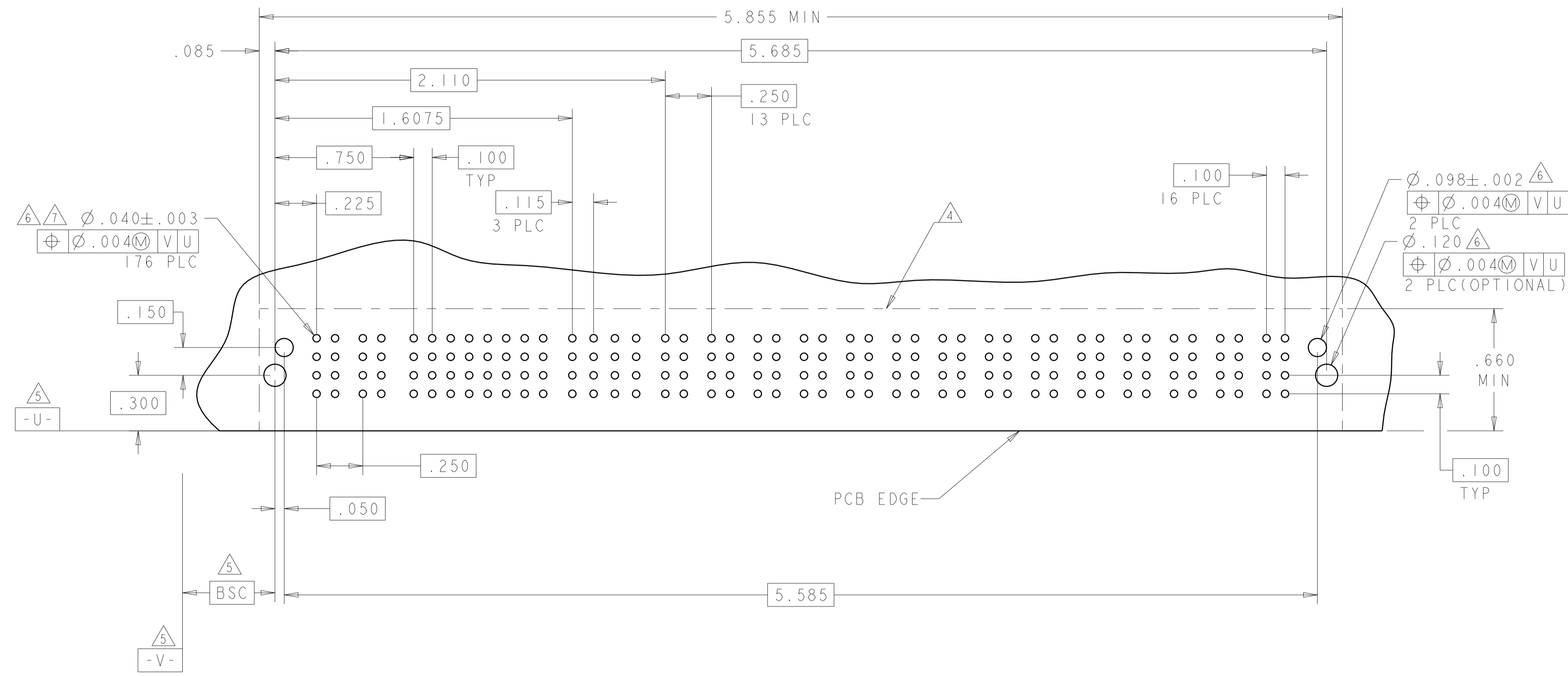

THIS DRAWING IS A CONTROLLED DOCUMENT.

DWN: ALEX SHOAL 14DEC2007	CHK: Sunny Zhao 20DEC2007	APVD: Sunny Zhao 20DEC2007	NAME: RIGHT ANGLE HEADER W/ LP CONTACT AND SHORT END MODULES MULTI-BEAM XLE
DIMENSIONS: INCHES	TOLERANCES UNLESS OTHERWISE SPECIFIED:	PRODUCT SPEC: 108-2292	APPLICATION SPEC: 114-13251
0 PLC ±	1 PLC ±.01	2 PLC ±.01	3 PLC ±.005
4 PLC ±.0050	ANGLES ±.2°	WEIGHT: -	RESTRICTED TO: -
MATERIAL: -	FINISH: -	SCALE: 1:1	SHEET 11 OF 16

Customer Drawing





LOC	DIST	REVISIONS			
ES	00	REV	DATE	BY	APPD
		-	SEE SHEET 1	-	-

PART NUMBER	ROWS	POWER						SIGNAL						POWER					
		P1	P2	P3	P4	P5	P6	1	2	3	4	5	6	P7	P8	P9	P10	P11	P12
2-6450840-7	D							Z5	Z5	Z5	Z5	Z5	Z5						
	C							Y5	Y5	Y5	Y5	Y5	Y5						
	B							R5	R5	R5	R5	R5	R5						
	A	HD						O1	O5	O5	O5	O5	O5						
6P + 24S + 6P																			

G7

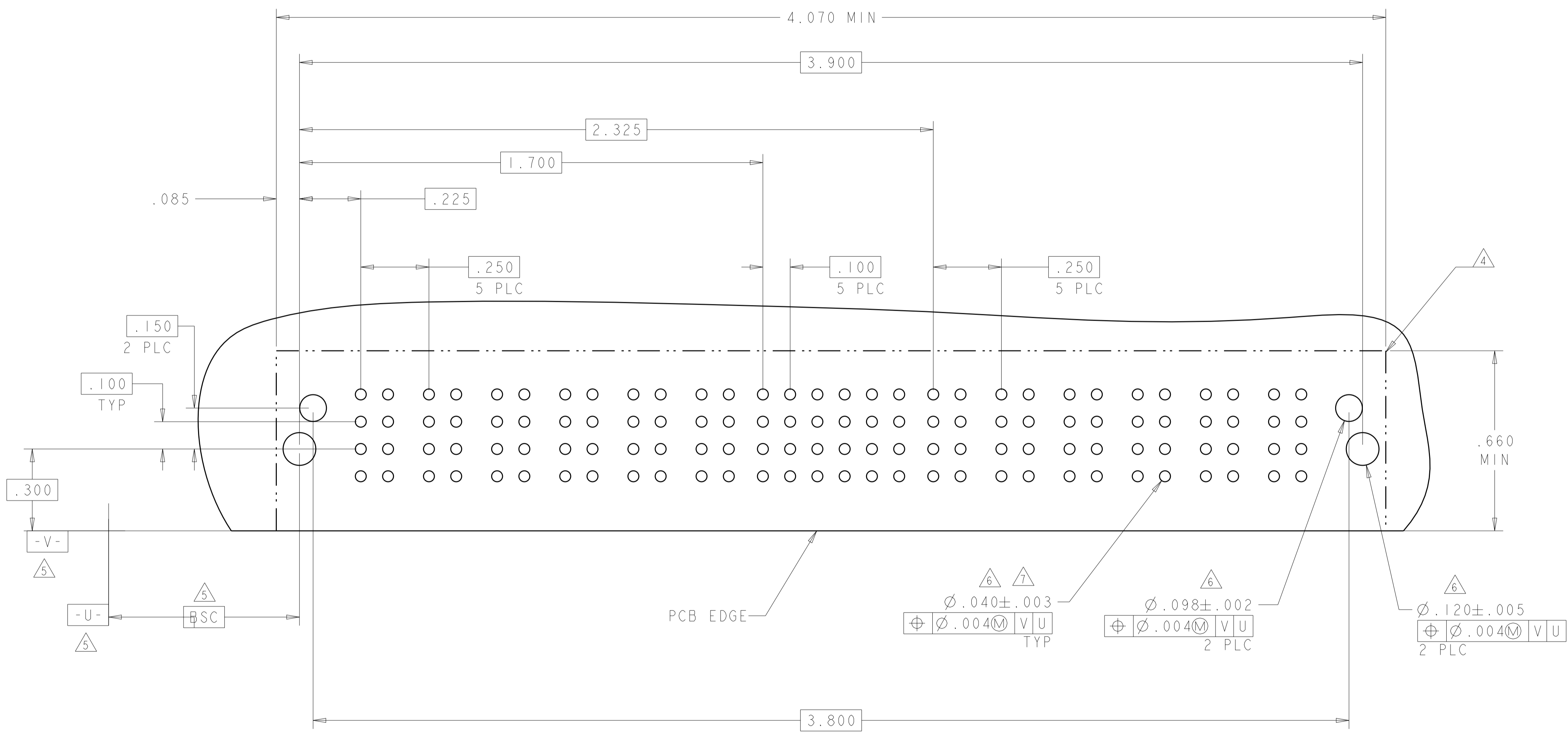

THIS DRAWING IS A CONTROLLED DOCUMENT.		OWN: ALEX SHOAL 14DEC2007													
DIMENSIONS: INCHES		CHK: Sunny Zhao 20DEC2007													
TOLERANCES UNLESS OTHERWISE SPECIFIED:		APVD: Sunny Zhao 20DEC2007	NAME: RIGHT ANGLE HEADER W/ LP CONTACT AND SHORT END MODULES MULTI-BEAM XLE												
<table border="1"> <tr><td>0 PLC</td><td>±</td></tr> <tr><td>1 PLC</td><td>±.01</td></tr> <tr><td>2 PLC</td><td>±.01</td></tr> <tr><td>3 PLC</td><td>±.005</td></tr> <tr><td>4 PLC</td><td>±.0050</td></tr> <tr><td>ANGLES</td><td>±.2°</td></tr> </table>		0 PLC	±	1 PLC	±.01	2 PLC	±.01	3 PLC	±.005	4 PLC	±.0050	ANGLES	±.2°	PRODUCT SPEC: 108-2292	SIZE: A100779
0 PLC	±														
1 PLC	±.01														
2 PLC	±.01														
3 PLC	±.005														
4 PLC	±.0050														
ANGLES	±.2°														
MATERIAL: -		APPLICATION SPEC: 114-13251	DRAWING NO: C=6450840												
FINISH: -		WEIGHT: -	RESTRICTED TO: -												
Customer Drawing		SCALE: 1:1	SHEET 14 OF 16 REV: H4												



LOC	DIST	REVISIONS					
		P	LTN	DESCRIPTION	DATE	DMN	APVD
ES	00	-	-	SEE SHEET 1	-	-	-

PART NUMBER	ROWS	POWER						SIGNAL						POWER				
		LP1	LP2	LP3	LP4	LP5	LP6	1	2	3	4	5	6	P1	P2	P3		
3-6450840-3	D C B A	[HD]	[LT]	[LT]	[LT]	[LT]	[LT]	[LT]	Z5	Z5	Z5	Z5	Z5	Z5	[TT]	[TT]	[TT]	[HD]
			[LT]	[LT]	[LT]	[LT]	[LT]	[LT]	Y5	Y5	Y5	Y5	Y5	Y5	[TT]	[TT]	[TT]	
			[LT]	[LT]	[LT]	[LT]	[LT]	[LT]	R5	R5	R5	R5	R5	R5	[TT]	[TT]	[TT]	
6LP + 24S + 3P								O5	O5	O5	O5	O5	O5					

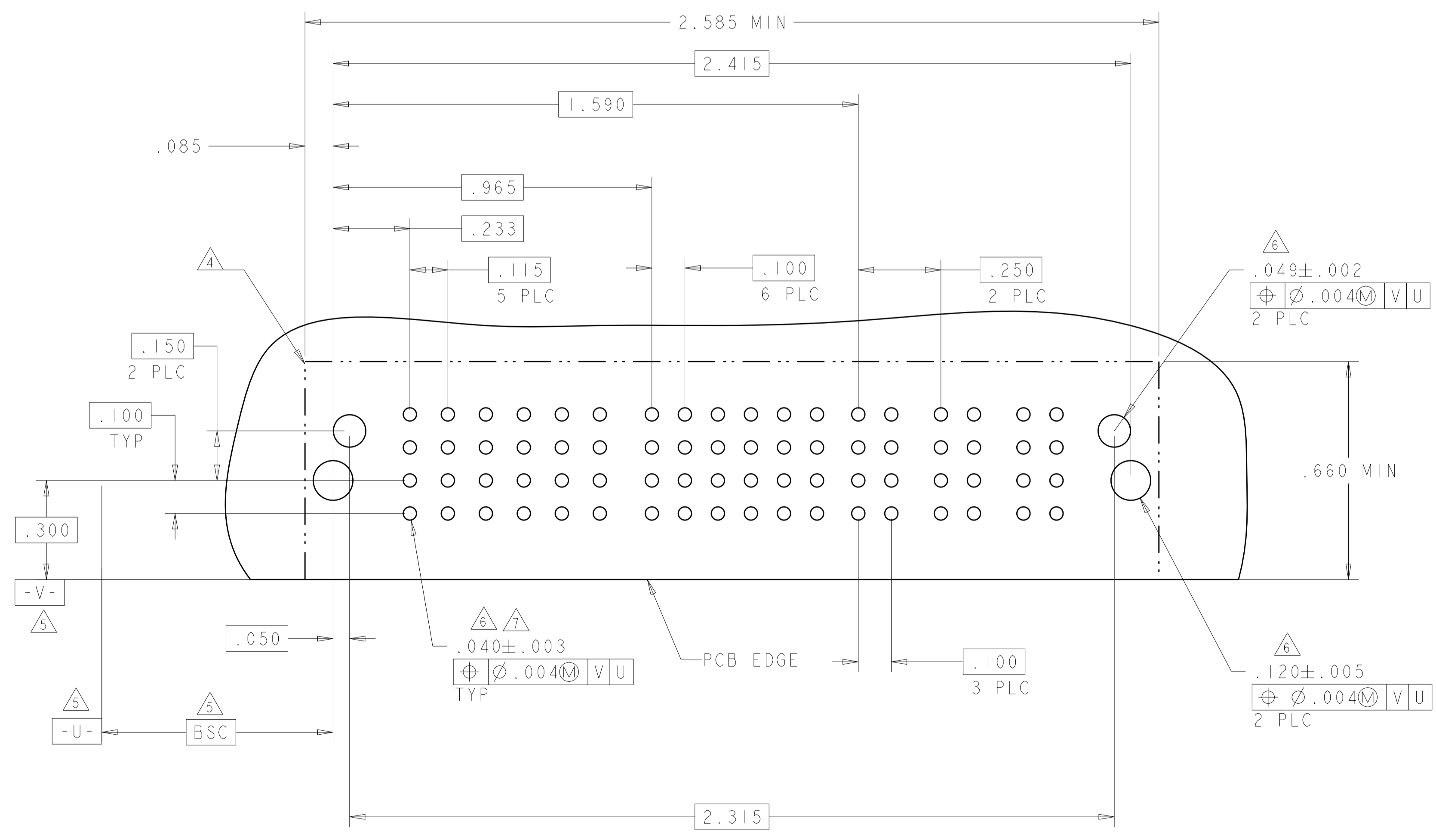

THIS DRAWING IS A CONTROLLED DOCUMENT.		DMN: ALEX SHOAL 14DEC2007	TE Connectivity														
DIMENSIONS: INCHES		CHK: Sunny Zhao 20DEC2007															
TOLERANCES UNLESS OTHERWISE SPECIFIED:		APVD: Sunny Zhao 20DEC2007	NAME: RIGHT ANGLE HEADER W/ LP CONTACT AND SHORT END MODULES MULTI-BEAM XLE														
<table border="1"> <tr><td>0 PLC</td><td>±.</td></tr> <tr><td>1 PLC</td><td>±.01</td></tr> <tr><td>2 PLC</td><td>±.01</td></tr> <tr><td>3 PLC</td><td>±.005</td></tr> <tr><td>4 PLC</td><td>±.0050</td></tr> <tr><td>ANGLES</td><td>±.2°</td></tr> <tr><td>FINISH</td><td></td></tr> </table>		0 PLC	±.	1 PLC	±.01	2 PLC	±.01	3 PLC	±.005	4 PLC	±.0050	ANGLES	±.2°	FINISH		PRODUCT SPEC: 108-2292	SIZE: A100779
0 PLC	±.																
1 PLC	±.01																
2 PLC	±.01																
3 PLC	±.005																
4 PLC	±.0050																
ANGLES	±.2°																
FINISH																	
MATERIAL: -		APPLICATION SPEC: 114-13251	CAGE CODE: C=6450840														
WEIGHT: -		RESTRICTED TO: -	SCALE: 1:1 SHEET 16 OF 16 REV: H4														
Customer Drawing																	



# Mouser Electronics

Authorized Distributor

Click to View Pricing, Inventory, Delivery & Lifecycle Information:

[TE Connectivity:](#)

[2-6450840-1](#)