

THIS DRAWING IS UNPUBLISHED.

RELEASED FOR PUBLICATION

2011

© COPYRIGHT 2011

ALL RIGHTS RESERVED.

LOC AI DIST -

REVISIONS

P	LTR	DESCRIPTION	DATE	DWN	APVD
	A	REVISED PER ECO-12-002880	14FEB12	KH	MS

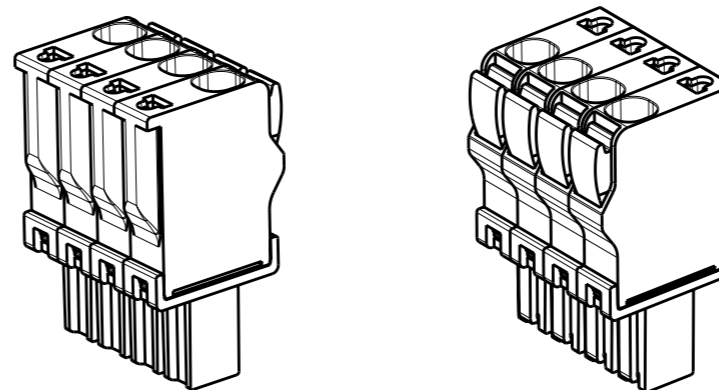
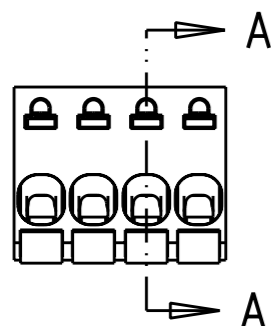
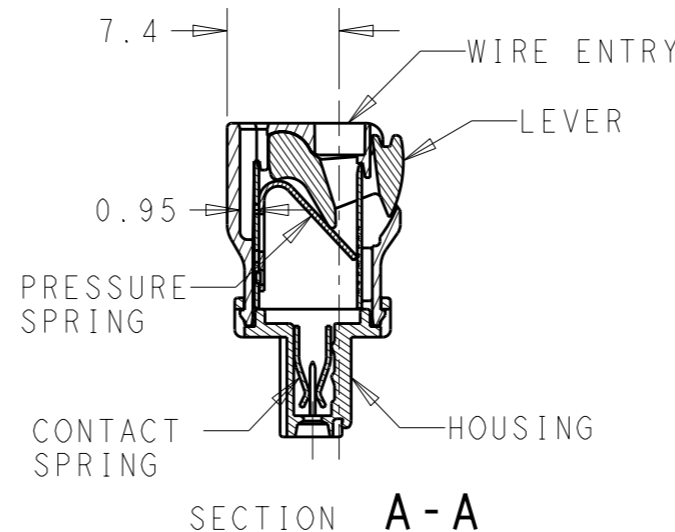
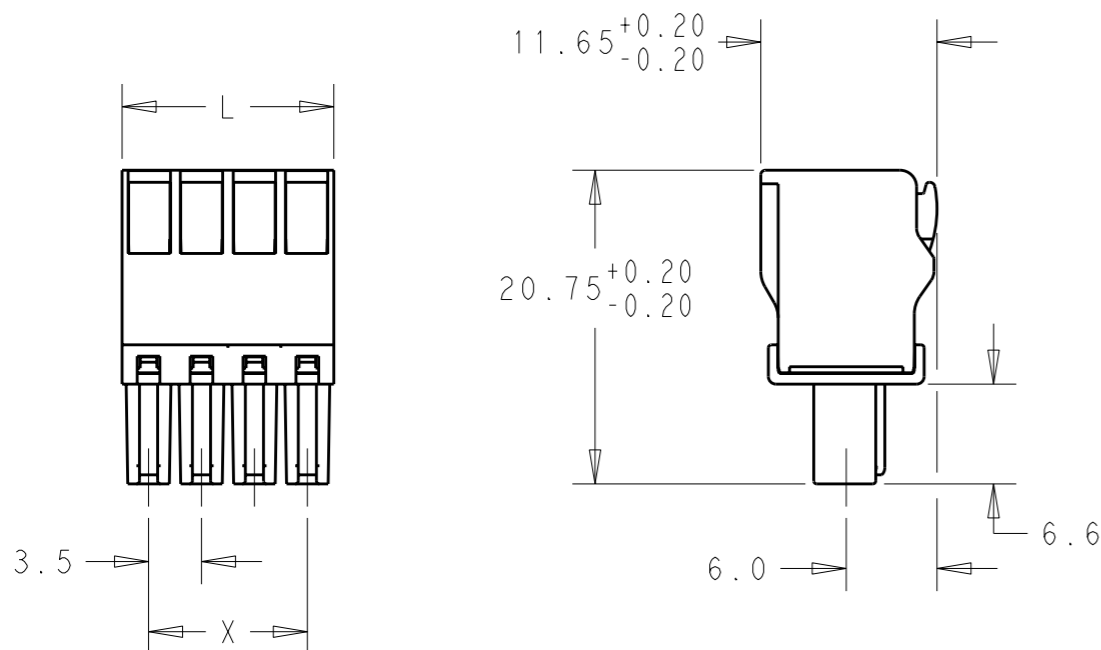

MATERIALS
 HOUSING-POLYAMIDE, COLOR-GREEN
 LEVER-POLYAMIDE, COLOR ORANGE
 CONTACT SPRING-COPPER ALLOY-LEAD FREE TIN PLATED
 CLAMPING SPRING-STEEL

MECHANICAL
 INSERTION FORCE PER POLE- 3 NEWTON MAX
 WITHDRAWAL FORCE PER POLE- 1.5 NEWTON MIN
 STRIPPING LENGTH- 10.5 TO 11.5 MM
 OPERATING TEMPERATURE--40°C TO +110°C

ELECTRICAL
 WIRE SIZE= 30 TO 14 AWG SOLID OR STRANDED
 VOLTAGE RATING- 300 VOLTS
 CURRENT RATING- 11 AMP STRANDED; 9AMP SOLID
 CONTACT RESISTANCE-15 MILLOHM MAX
 INSULATION RESISTANCE-10⁹ OHMS MIN (500V DC)

84.00	87.50	25	2-1986692-5
80.50	84.00	24	2-1986692-4
77.00	80.50	23	2-1986692-3
73.50	77.00	22	2-1986692-2
70.00	73.50	21	2-1986692-1
66.50	70.00	20	2-1986692-0
63.00	66.50	19	1-1986692-9
59.50	63.00	18	1-1986692-8
56.00	59.50	17	1-1986692-7
52.50	56.00	16	1-1986692-6
49.00	52.50	15	1-1986692-5
45.50	49.00	14	1-1986692-4
42.00	45.50	13	1-1986692-3
38.50	42.00	12	1-1986692-2
35.00	38.50	11	1-1986692-1
31.50	35.00	10	1-1986692-0
28.00	31.50	9	1986692-9
24.50	28.00	8	1986692-8
21.00	24.50	7	1986692-7
17.50	21.00	6	1986692-6
14.00	17.50	5	1986692-5
10.50	14.00	4	1986692-4
7.00	10.50	3	1986692-3
3.50	7.00	2	1986692-2
DIM X	DIM L	POLE	PART NUMBER

THIS DRAWING IS A CONTROLLED DOCUMENT.		DWN 12JAN2012 KIRAN HOLAL	TE Connectivity													
DIMENSIONS: mm		CHK 12JAN2012 MIKE SARVER														
TOLERANCES UNLESS OTHERWISE SPECIFIED:		APVD 12JAN2012 MIKE SARVER	NAME STRAIGHT SPRING TYPE PLUG CONNECTOR													
<table border="1"> <tr><td>0 PLC</td><td>±-</td></tr> <tr><td>1 PLC</td><td>±0.40</td></tr> <tr><td>2 PLC</td><td>±0.20</td></tr> <tr><td>3 PLC</td><td>±-</td></tr> <tr><td>4 PLC</td><td>±-</td></tr> <tr><td>ANGLES</td><td>±1°</td></tr> </table>		0 PLC	±-	1 PLC	±0.40	2 PLC	±0.20	3 PLC	±-	4 PLC	±-	ANGLES	±1°	PRODUCT SPEC	SIDE STACKABLE RIGHT	
0 PLC	±-															
1 PLC	±0.40															
2 PLC	±0.20															
3 PLC	±-															
4 PLC	±-															
ANGLES	±1°															
MATERIAL - FINISH -		APPLICATION SPEC	02 - 25 POLES PITCH 3.50mm													
		WEIGHT -	SIZE A3	RESTRICTED TO -												
		CUSTOMER DRAWING	CAGE CODE 00779	DRAWING NO C-1986692												
			SCALE 2:1	SHEET 1 OF 1 REV A												

Mouser Electronics

Authorized Distributor

Click to View Pricing, Inventory, Delivery & Lifecycle Information:

[TE Connectivity:](#)

[2-1986692-3](#)