

HIGH EFFICIENCY RECTIFIER

VOLTAGE RANGE 50 to 1000 Volts CURRENT 1.0 Ampere

FEATURES

- * Low power loss, high efficiency
- * Low leakage
- * Low forward voltage
- * High current capability
- * High speed switching
- * High surge capability
- * High reliability

MECHANICAL DATA

- * Case: Molded plastic
- * Epoxy: Device has UL flammability classification 94V-0
- * Lead: MIL-STD-202E method 208C guaranteed
- * Mounting position: Any
- * Weight: 0.35 gram

MAXIMUM RATINGS AND ELECTRICAL CHARACTERISTICS

Ratings at 25 °C ambient temperature unless otherwise specified.
Single phase, half wave, 60 Hz, resistive or inductive load.
For capacitive load, derate current by 20%.

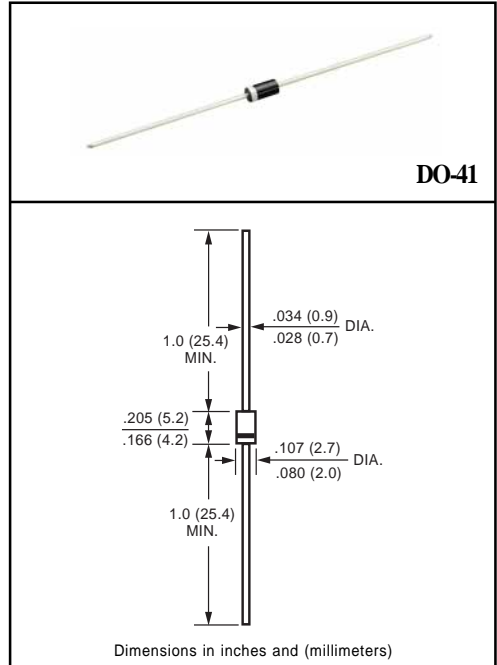

MAXIMUM RATINGS (At TA = 25°C unless otherwise noted)

RATINGS	SYMBOL	HER101	HER102	HER103	HER104	HER105	HER106	HER107	HER108	UNITS
Maximum Recurrent Peak Reverse Voltage	VRRM	50	100	200	300	400	600	800	1000	Volts
Maximum RMS Voltage	VRMS	35	70	140	210	280	420	560	700	Volts
Maximum DC Blocking Voltage	Vdc	50	100	200	300	400	600	800	1000	Volts
Maximum Average Forward Rectified Current at TA= 50°C	Io	1.0								Amps
Peak Forward Surge Current 8.3 ms single half sine-wave superimposed on rated load (JEDEC method)	IFSM	30								Amps
Typical Junction Capacitance (Note 2)	CJ	15				12				pF
Typical Thermal Resistance	RθJA	60								°C/W
Typical Thermal Resistance	RθJC	18								°C/W
Operating and Storage Temperature Range	TJ, TSTG	-55 to + 150								°C

ELECTRICAL CHARACTERISTICS (At TA = 25°C unless otherwise noted)

CHARACTERISTICS	SYMBOL	HER101	HER102	HER103	HER104	HER105	HER106	HER107	HER108	UNITS	
Maximum Instantaneous Forward Voltage at 1.0A DC	VF	1.0			1.3		1.7			Volts	
Maximum DC Reverse Current at Rated DC Blocking Voltage TA = 25°C	IR	5.0									uAmps
Maximum Full Load Reverse Current Average, Full Cycle .375" (9.5mm) lead length at TL = 55°C		100									uAmps
Maximum Reverse Recovery Time (Note 1)	trr	50					75				nSec

- NOTES : 1. Test Conditions: IF = 0.5A, IR = -1.0A, IRR = -0.25A
2. Measured at 1 MHz and applied reverse voltage of 4.0 volts
3. "Fully ROHS compliant", "100% Sn plating (Pb-free)".

RATING AND CHARACTERISTIC CURVES (HER101 THRU HER108)

FIG. 1 - TEST CIRCUIT DIAGRAM AND REVERSE RECOVERY TIME CHARACTERISTIC

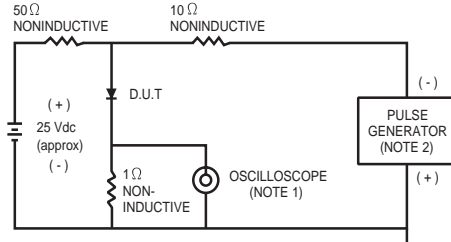

NOTES: 1. Rise Time = 7ns max. Input Impedance = 1 megohm, 22pF.
2. Rise Time = 10ns max. Source Impedance = 50 ohms.

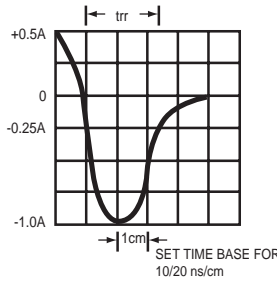

FIG. 2 - TYPICAL FORWARD CURRENT DERATING CURVE

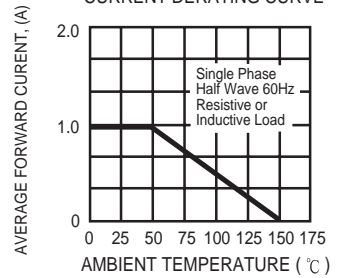

FIG. 3 - TYPICAL REVERSE CHARACTERISTICS

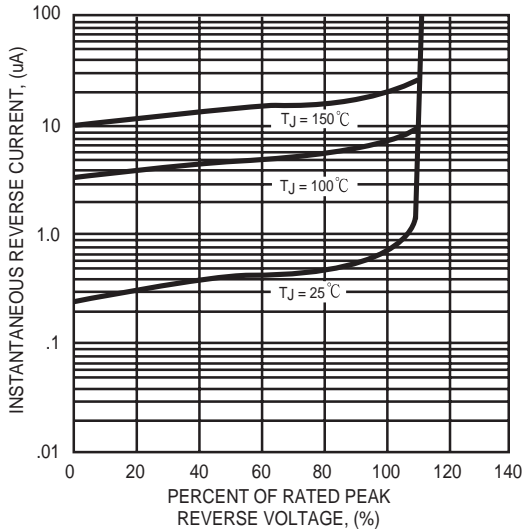

FIG. 4 - TYPICAL INSTANTANEOUS FORWARD CHARACTERISTICS

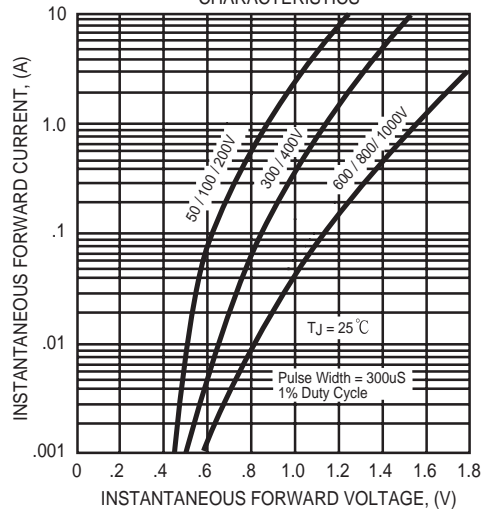

FIG. 5 - MAXIMUM NON-REPETITIVE FORWARD SURGE CURRENT

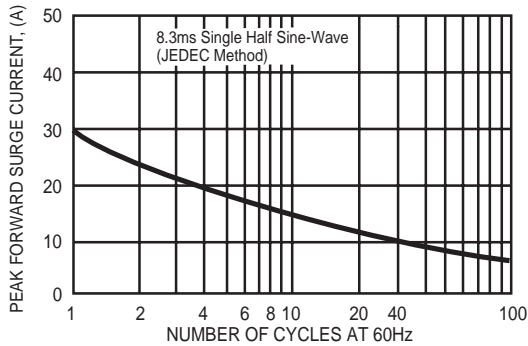
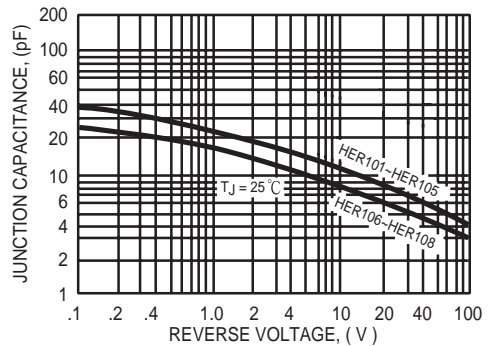

FIG. 6 - TYPICAL JUNCTION CAPACITANCE



Mouser Electronics

Authorized Distributor

Click to View Pricing, Inventory, Delivery & Lifecycle Information:

Rectron:

[HER101-B](#) [HER103-B](#) [HER104-B](#) [HER105-B](#) [HER106-B](#) [HER107-B](#) [HER108-B](#) [HER101-T](#) [HER108-T](#) [HER153-T](#) [HER153-B](#) [HER103-T](#) [HER107-T](#) [HER105-T](#) [HER108-T-S-R01-B](#) [HER108-T-S-R01-T](#) [HER108-T-S-NT-B](#) [HER108-T-S-NT-T](#) [HER154-T](#) [HER154-B](#) [HER106-T](#) [HER152-T](#) [HER152-B](#) [HER156-T](#) [HER156-B](#) [HER155-T](#) [HER155-B](#) [HER151-B](#) [HER151-T](#) [HER104-T](#) [HER102-B](#) [HER102-T](#) [HER105-T-S-NT-B](#) [HER105-T-S-NT-T](#)