

8 Series Pushbutton Switches

■ Features

1. Contacts

Silver or gold-plated contacts.

2. Epoxy resin case

UL94V-0 self-extinguishing epoxy.

3. Actuator style

Over 30 actuator variations.

4. Insulation between terminal and ground: 4 mm minimum.

5. Prevention of flux entry

The epoxy resin seal on bottom of the switch helps prevent the entry of solder and flux.

6. Insulation barrier:

Insulation barrier design between poles helps prevent short-circuiting between poles ensuring high reliability.

7. For UL-recognized and CSA-approved products, please refer to P.276.

■ Specifications







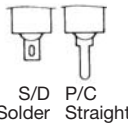

Rating	Max. rating	6A 125VAC/3A 250VAC/4A 30VDC	
Initial contact resistance	10mΩmax. (1A 2~4VDC)		
Initial dielectric strength	1,500VAC 1 minute		
Initial insulation resistance	1,000MΩ min. (500VDC)		
Electrical life (Excluding 8R & 8W)	Alternate type	40,000 operations	
	Momentary type	25,000 operations	
Operating temperature range	-30°C~+85°C		
Storage temperature range	-40°C~+85°C		

(Excluding **8R** & **8W**. Specifications on 8R and 8W series are specified separately on P.264 and P.269.)

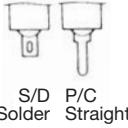
■ Terminal Styles

Solder (Style:1)	Straight (Style:2)
<p>t=0.8</p>	<p>t=0.8</p>

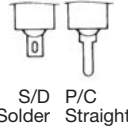
8 Series Pushbutton Switches Selection Table

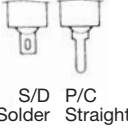
Part No.	Name	Actuator shape	Number of poles	Switching function	Terminal style	Page
8N	Standard Pushbutton		1.2.3.4	ON — ON ON — (ON)	 S/D Solder P/C Straight	261
8P	Splash Proof Pushbutton		1.2.3.4	ON — ON ON — (ON)	 S/D Solder P/C Straight	263
8Y	Mustang Pushbutton		1.2.3.4	ON — ON ON — (ON)	 S/D Solder	265
8R-N	Soft Touch Pushbutton		1.2	ON — ON ON — (ON)	 S/D Solder P/C Straight	267
8W-N	Snap-in Pushbutton		1.2	ON — (ON)	 S/D Solder P/C Straight	269

Part Numbering

8

Series code

N

Actuator shape

1

Number of poles

01

Switching function

1

Terminal style

B — Z

(※1) Contact plating and material

Code	Actuator
N	Standard
P	Splash proof
Y	Mustang
R	Soft Touch
W	Snap-in

Fig.	Number of poles
1	1
2	2
3	3
4	4

Fig.	Switching function
01	ON — ON
02	ON — (ON)

Fig.	Terminal style
1	Solder
2	PC/Straight

Code	Contact material	Plating
None	Bs+Ag or Cu+Ag	Ag
B	Bs or Cu	Ni+Au
C	Bs+Ag or Cu+Ag	Ni+Au

※1 Bs= Brass
Cu= Copper
Ag= Silver
Ni= Nickel
Au= Gold

Note : Some combinations may not be available. Please check the "Table of Part Numbers" for each series.

8N

Standard Pushbutton Switches



RoHS Compliant

■ Features

The **8N** standard pushbutton switch is the basic type of “8” Series. Momentary and alternate functions are available.

Color button is available in 8mm, 10mm and 15mm diameter and in eight colors.

■ Table of Part Numbers

Terminal style	No. of pole		1 pole	2 poles	3 poles	4 poles
	Switching function					
Solder Lug	ON — ON		8N1011-Z ★ 8N1011C-Z	☆ 8N2011-Z ▲ 8N2011C-Z	★ 8N3011-Z _____	▲ 8N4011-Z _____
	ON — (ON)		8N1021-Z ▲ 8N1021C-Z	8N2021-Z ★ 8N2021C-Z	★ 8N3021-Z _____	★ 8N4021-Z _____
Straight PC	ON — ON		★ 8N1012-Z	★ 8N2012-Z	_____	_____
	ON — (ON)		☆ 8N1022-Z	☆ 8N2022-Z	_____	_____

■ PC Hole Layouts Page 275.

■ Color Button Mounting

Snap in the color button on to the actuator.

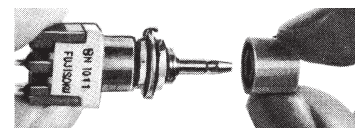

■ Standard Accessories

《Supplied with switch》

Hex Nut	Lockwasher	Locking Ring
140008010241	140008030051	140008020062
Nickel plated	Zinc plated	Zinc plated

■ Panel Cut-Out Dimensions

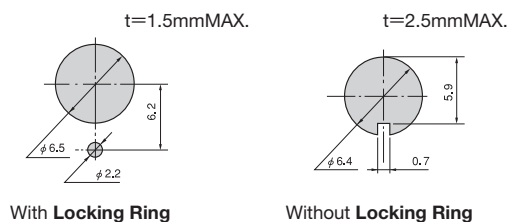

Part name		Color Button		
Dimension A		φ 8	φ 10	φ 15
Dimension B		7.5	8	10
 (Material : PA)	White	140000481420	140000480082	140000480088
	Red	140000481421	140000480083	140000480089
	Black	140000481422	140000480081	140000480090
	Gray	140000481423	140000480084	140000480091
	Green	140000481424	140000480085	140000480092
	Blue	140000481425	140000480086	140000480093
	Orange	140000481426	140000480087	140000480094
	Yellow	140000481427	140000480371	140000480372

★ : Made to order products. ☆ : Semi-standard products. ▲ : Inquiry products. (ON) : Momentary.

●Hex Nut (2 pcs), Lockwasher (1 pc), and Locking Ring (1 pc) are supplied with the switch. A Color Button is also supplied with the switch. Please specify the part number from the above table when ordering.

8N

SPDT

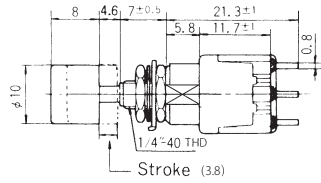
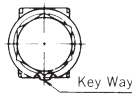

Switching function		
Part No.		
※ 8N101- Z	ON	ON
8N102- Z	ON	(ON)
Connecting terminals	2-3	2-1

■ : Please refer to "Table of Part Numbers" on P.261 for a list of full part numbers.

Terminal numbers are not shown on the switch.

DPDT

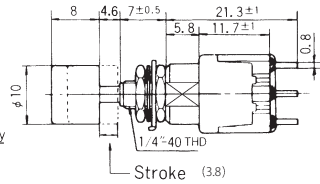
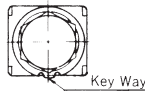

Switching function		
Part No.		
※ 8N201- Z	ON	ON
8N202- Z	ON	(ON)
Connecting terminals	2-3 5-6	2-1 5-4

■ : Please refer to "Table of Part Numbers" on P.261 for a list of full part numbers.

Terminal numbers are not shown on the switch.

3PDT

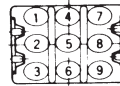
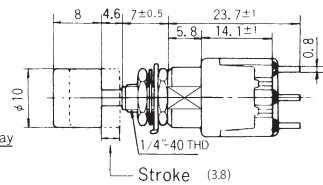
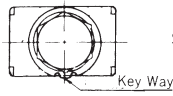

Switching function		
Part No.		
※ 8N301- Z	ON	ON
8N302- Z	ON	(ON)
Connecting terminals	2-3 5-6 8-9	2-1 5-4 8-7

■ : Please refer to "Table of Part Numbers" on P.261 for a list of full part numbers.

Terminal numbers are not shown on the switch.

4PDT

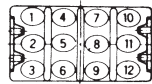
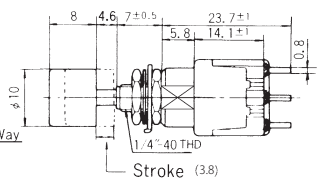
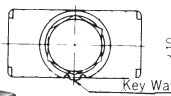

Switching function		
Part No.		
※ 8N401- Z	ON	ON
8N402- Z	ON	(ON)
Connecting terminals	2-3 5-6 8-9 11-12	2-1 5-4 8-7 11-10

■ : Please refer to "Table of Part Numbers" on P.261 for a list of full part numbers.

Terminal numbers are not shown on the switch.

Panel Cut-Out Dimensions

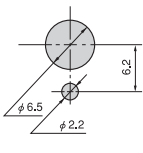
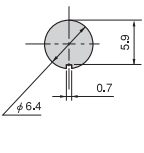
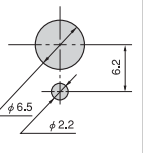
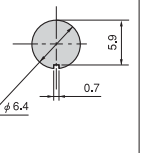
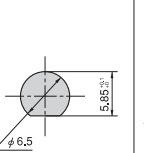
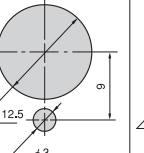
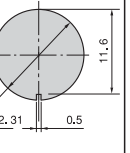
Series	8N		8R		8P	8Y	
Panel thickness	1.5 mm Max.	2.5 mm Max.	2 mm Max.	3 mm Max.	4.5 mm Max.	5 mm Max.	6 mm Max.
Dimensions	 With Locking Ring	 Without Locking Ring	 With Locking Ring	 Without Locking Ring	 With Locking Ring	 With Locking Ring	 Without Locking Ring

PC Hole Layouts

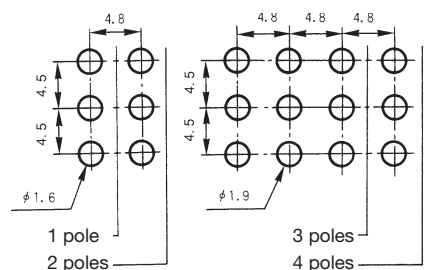
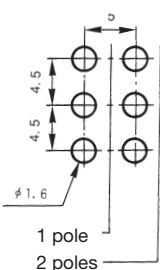
Series	8N · 8P	8R · 8W
Dimensions	 <p>1 pole 2 poles 3 poles 4 poles</p>	 <p>1 pole 2 poles</p>

Precautions (8N·8P·8R·8W·8Y)

1. Soldering Specifications

- (1) Manual soldering
 - Device : Solder iron
 - ① 420°C Max. 3 sec. Max.
- (2) Auto soldering
 - ② The above-stated soldering conditions shall apply only to switches with straight terminals. Auto soldering is not possible with right-angle terminals. Switches with right-angle terminals should be soldered manually according to the conditions specified in (1) above.
- (3) When putting the switches through an aging process after they were soldered onto the printing board or after installed into a complete end product, be sure to remove the buttons of the switches.,

2. Mounting

- Do not bend the terminals before mounting the switch on the PC board.
- After mounting the switch, do not place the device in such a way that the device weight will be applied on to the actuator of the switch.
- For switches with straight terminals, solder the switch on the PC board after fixing the switch on the panel with a nut.

3. Flux Cleaning

- (1) Solvent : Fluorine or Alcohol type.
- (2) 8A/B/C/D/E/F/J/S series are not washable. To wash the PC board, clean the soldering surface of the PC board with a brush so that the switch is not exposed to the cleaning solution.

Packaging Specification

