

PRODUCT NUMBER

SEE PART NO. TABLE

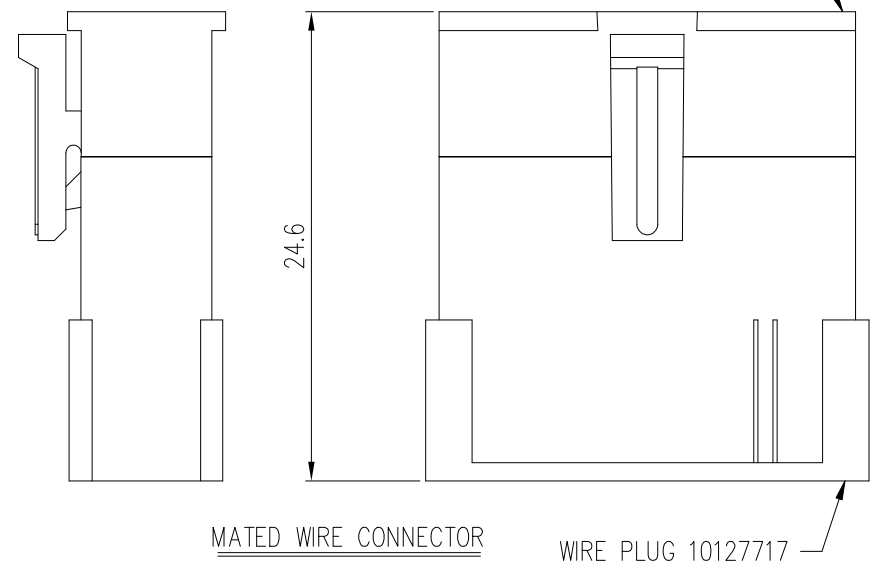
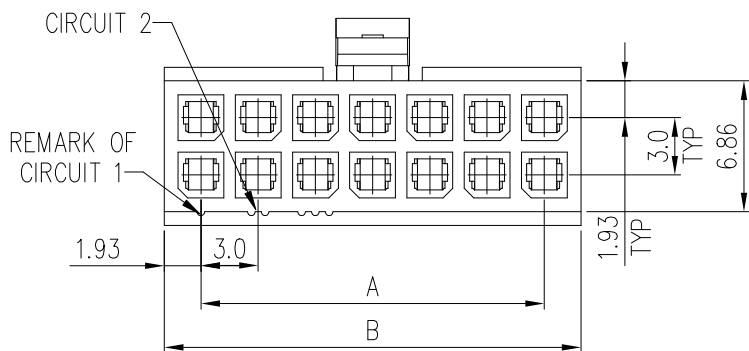
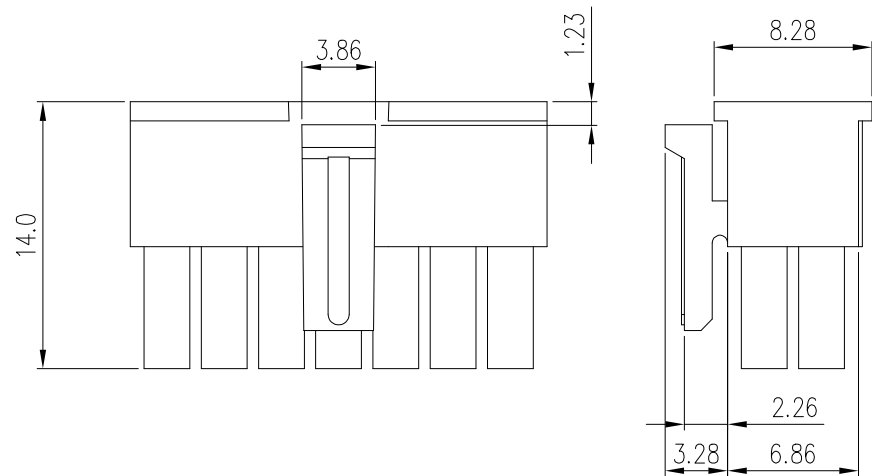
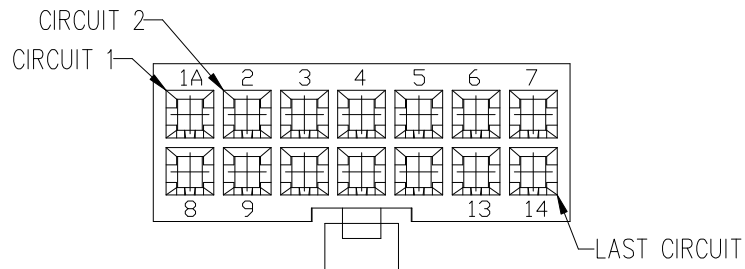

NOTES:

1. MATERIAL: NYLON 66, UL 94V-0.
2. THIS HSG IS USED WITH FCI RECEPTACLE TERMINAL 10127718.
3. THIS RECEPTACLE MATES WITH FCI PLUG 10127717, 10127720 & 10127721.
4. PRODUCT SPECIFICATION: GS-12-1177.
5. PACKAGE SPECIFICATION: GS-14-2359.
6. PART NUMBER SCHEME: 10127716- XX X LF

POS. CODE:
02: 2 POS.
04: 4 POS.
5
24: 24 POS.

MATERIAL
BLANK: NON GLOW WIRE COMPATIBLE, BLACK.
G: GLOW WIRE COMPATIBLE, BLACK.
1: NON GLOW WIRE COMPATIBLE, NATURAL
2: GLOW WIRE COMPATIBLE, NATURAL

DIMENSIONAL & PART NO. TABLE:

PART NO.	POS	A	B
10127716-02XLF	2	3.85	
10127716-04XLF	4	3.0	6.85
10127716-06XLF	6	6.0	9.85
10127716-08XLF	8	9.0	12.85
10127716-10XLF	10	12.0	15.85
10127716-12XLF	12	15.0	18.85
10127716-14XLF	14	18.0	21.85
10127716-16XLF	16	21.0	24.85
10127716-18XLF	18	24.0	27.85
10127716-20XLF	20	27.0	30.85
10127716-22XLF	22	30.0	33.85
10127716-24XLF	24	33.0	36.85

mat'l. code		surface ISO 1302 ✓		tolerance ISO 406 ISO 1101		projection		product family	
ltr	ecn no	dr	date	tolerances unless otherwise specified		1101		title	
A	--	Tai	2013-10-21	angles		mm		MINITEK PWR3.0 WIRE CONNECTOR, RECEPTACLE HSG, DUAL ROW	
B	ELX-T-21897	Tai	2015-08-24	linear		mm		dwg no	
C	ELX-2-26735	MZ	2017-04-20	0°±3'		scale 1:1		sheet 1 of 2	
D	ELX-N-28649	TONY	2017-11-30	dr	KENNY TAI	2013-10-21	Amphenol FCI		size
				engr	KENNY TAI	2013-10-21	10127716		A3
				chr	KENNY TAI	2013-10-21	type		Product Customer Drawing
				appd	PM ZHENG	2013-11-06			
sheet index	revision sheet	D	D						
	1	2							

Amphenol FCI

© 2016 AFCI

© 2016 AFCE
 Amphenol FCI

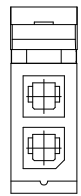

2 POS

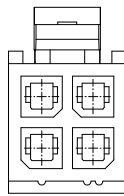

4 POS

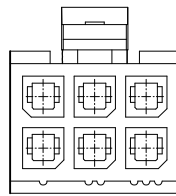

6 POS

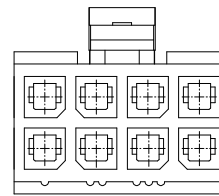

8 POS

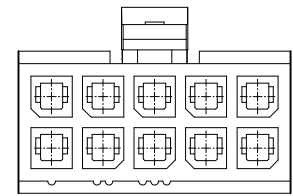

10 POS

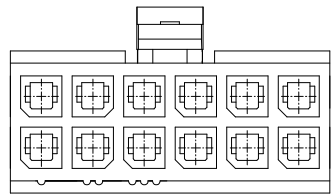

12 POS

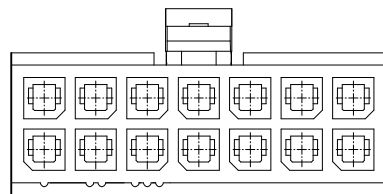

14 POS

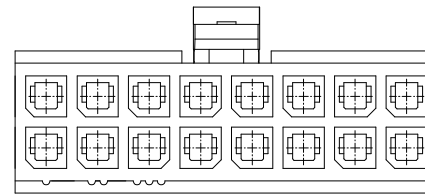

16 POS

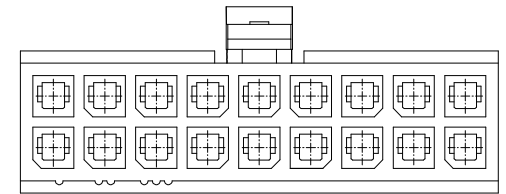

18 POS

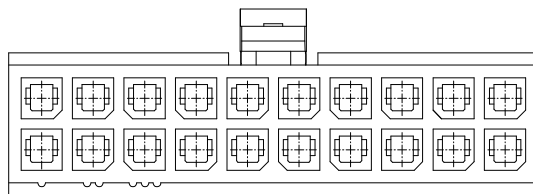

20 POS

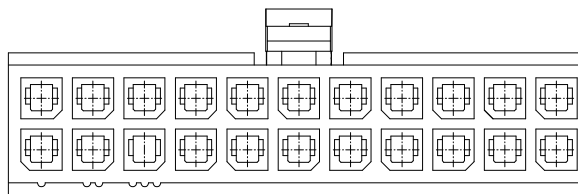

22 POS

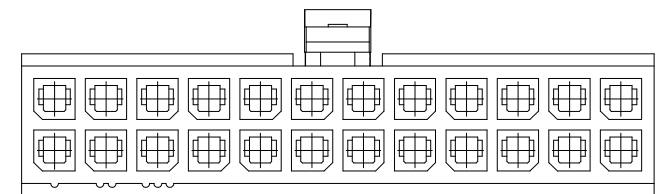

24 POS

mat'l. code		surface ISO 1302 ✓		tolerance ISO 406 ISO 1101		projection		product family		
ltr	ecn no	dr	date	tolerances unless otherwise specified		mm		title		
D				angles	linear	scale 1:1		MINITEK PWR3.0 WIRE CONNECTOR, RECEPTACLE HSG, DUAL ROW		
				0°±3'				dwg no sheet2 of 2 size		
				dr	KENNY TAI	2013-10-21	Amphenol FCI		10127716 A3	
				engr	KENNY TAI	2013-10-21				
				chr	KENNY TAI	2013-10-21				
				appd	PM ZHENG	2013-11-06				
sheet index	revision sheet	D	D							type Product Customer Drawing
	1 2									

Mouser Electronics

Authorized Distributor

Click to View Pricing, Inventory, Delivery & Lifecycle Information:

[FCI / Amphenol:](#)

[10127716-24LF](#) [10127716-10LF](#) [10127716-16LF](#) [10127716-04LF](#) [10127716-06LF](#) [10127716-22LF](#) [10127716-02LF](#) [10127716-20LF](#) [10127716-08LF](#) [10127716-12LF](#) [10127716-14LF](#) [10127716-18LF](#) [10127716-04GLF](#) [10127716-06GLF](#) [10127716-02GLF](#)