

LOC		DIST		REVISIONS			
ES	00	P	LTM	DESCRIPTION	DATE	DWN	APVD
		J1		REV PER ECR-12-016975	25SEP2012	CZ	SZ
		J3		ADDED NEW DASH NUMBER 4-0	01FEB2013	CZ	SZ
		J5		ADDED NEW DASH NUMBER 4-1	25FEB2014	CZ	SZ

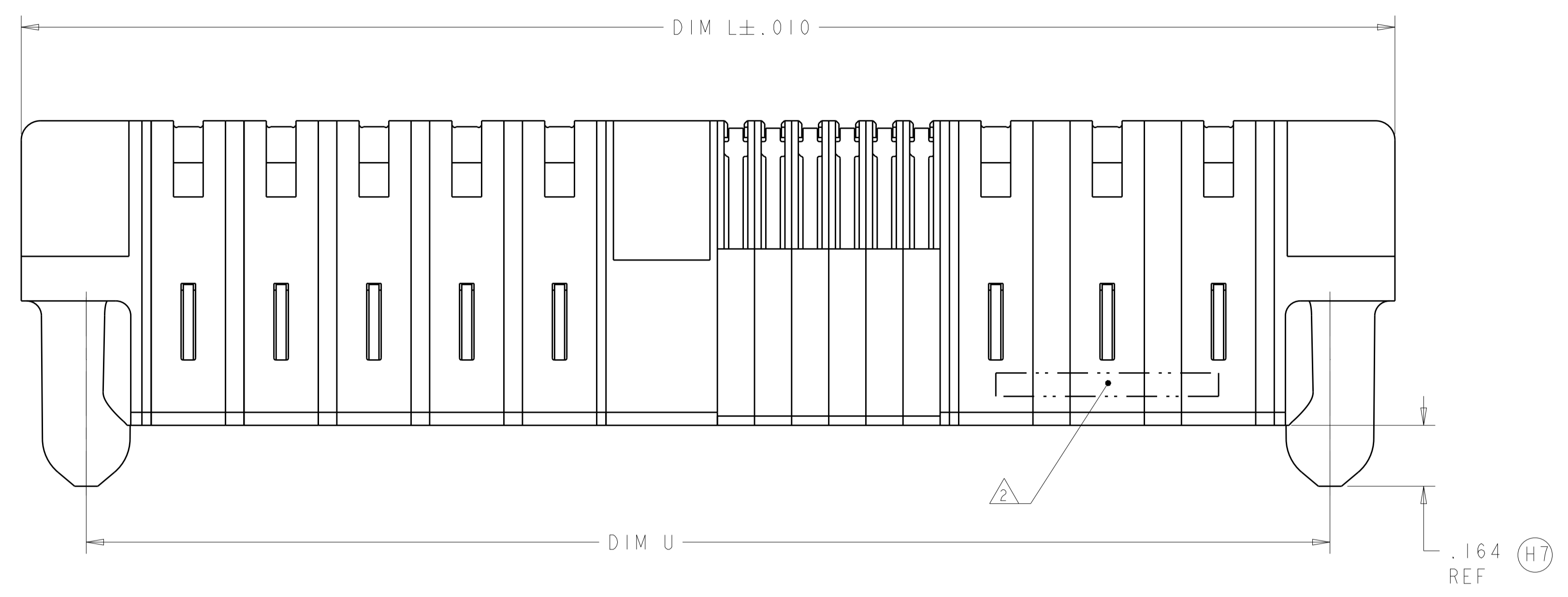

- △1 OPTIONAL CENTER MODULE, WITH .150 THRU HOLE OR HOLD DOWN FEATURE.
- △2 "AMP", PART NUMBER AND DATE CODE TO BE MARKED
- △3 MATERIAL: HOUSING - GLASS FILLED HIGH TEMP THERMO PLASTIC, UL94 V-0.
 SIGNAL CONTACT - HIGH CONDUCTIVITY COPPER ALLOY
 POWER CONTACT - HIGH CONDUCTIVITY COPPER ALLOY
- △4 CONTACT PLATING: NOBLE METAL PLATING ON CONTACT FUNCTIONAL AREA OF POWER AND SIGNAL CONTACTS
- △5 MECHANICAL CONNECTOR KEEP OUT ZONE.
- △6 DATUM AND BASIC DIMENSIONS ESTABLISHED BY CUSTOMER.
- △7 PCB - ALL HOLE DIAMETERS ARE FINISHED HOLE SIZES
- △8 PCB - .0453±.0010 DRILLED HOLES PLATED WITH .0003 MIN Sn OVER .001 TO .003 Cu PLATING TO ACHIEVE A .040 DIAMETER HOLE

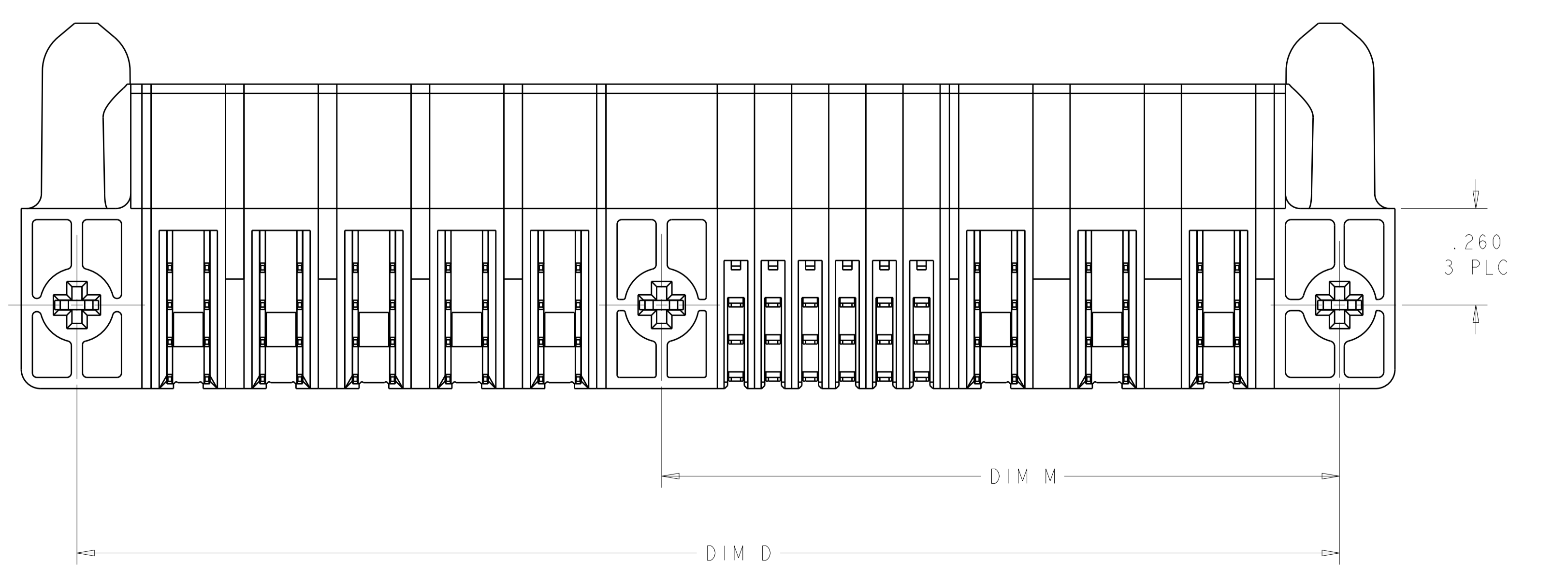
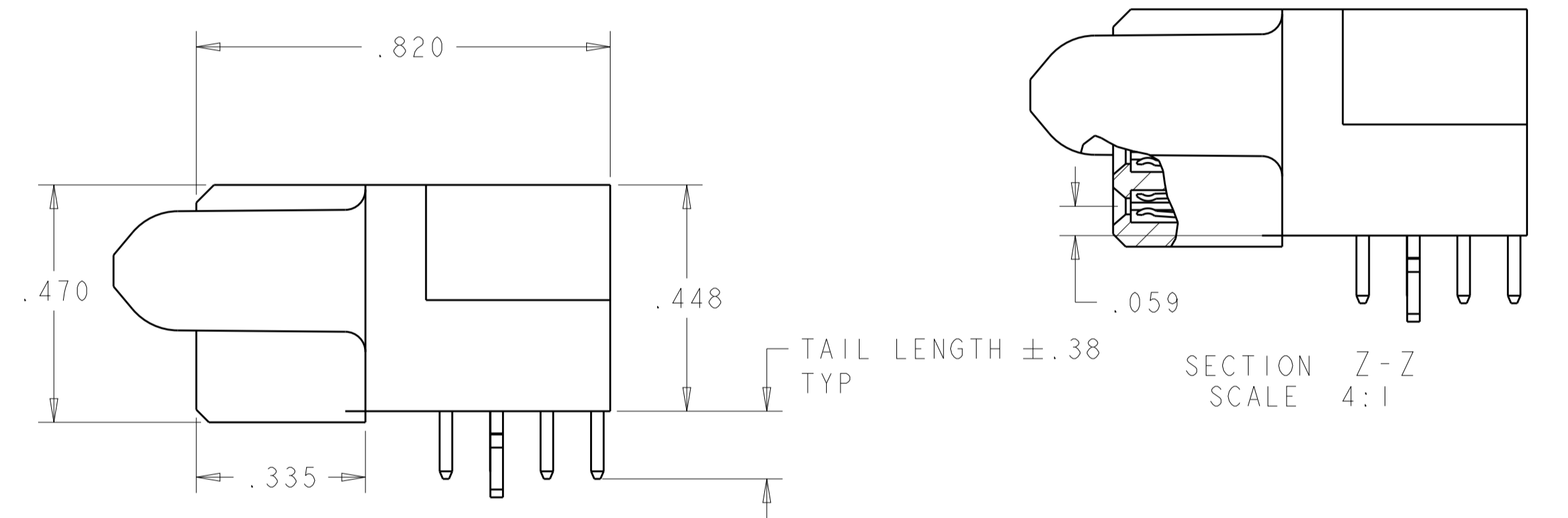
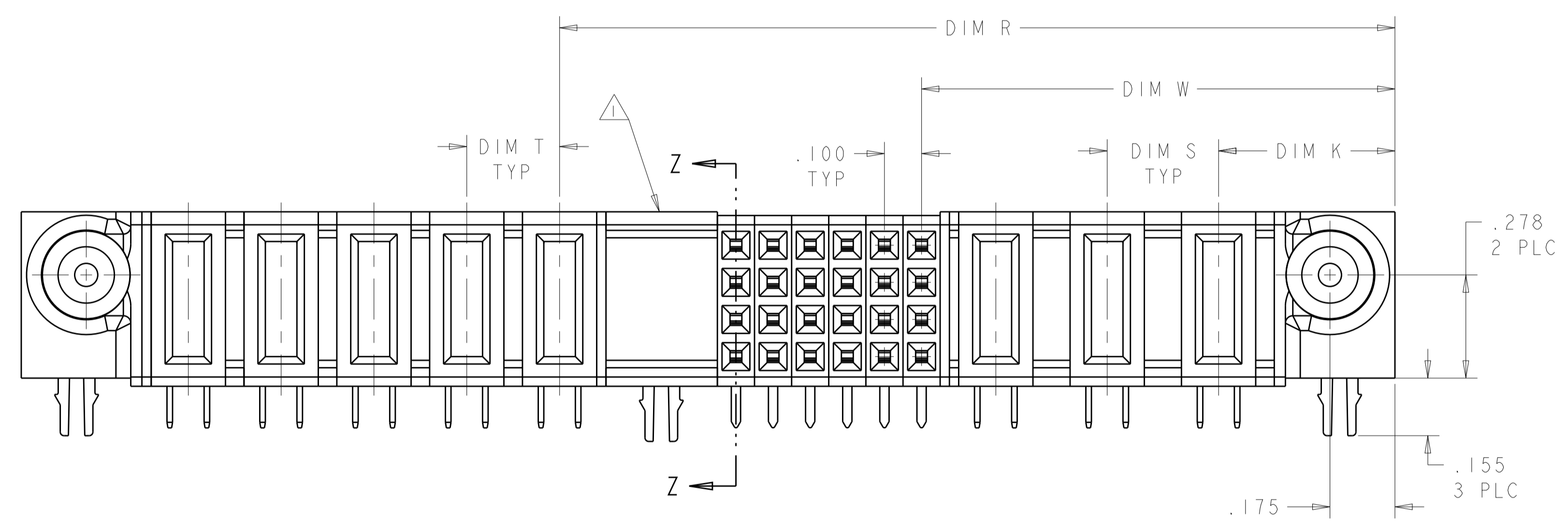

THIS DRAWING IS A CONTROLLED DOCUMENT.		DWN: R.GRZYBOWSKI 21FEB05	TE Connectivity
DIMENSIONS: INCHES		CHK: M.PERCHEKKE 21FEB05	
TOLERANCES UNLESS OTHERWISE SPECIFIED:		APVD: M.PERCHEKKE	NAME: RIGHT ANGLE RECEPTACLE ASSEMBLY WITH GUIDES MULTI-BEAM XL
0 PLC ±.	1 PLC ±.01	PRODUCT SPEC: 108-1973	SIZE: 114-13038
2 PLC ±.005	3 PLC ±.0020	APPLICATION SPEC: 114-13038	RESTRICTED TO: A100779C=6450170
4 PLC ±.0020	ANGLES ±.020	WEIGHT: -	SCALE: 4:1
MATERIAL: -	FINISH: -	CUSTOMER DRAWING	SHEET 1 OF 13 REV J5

THIS DRAWING IS UNPUBLISHED. RELEASED FOR PUBLICATION 20
 © COPYRIGHT 20 BY - ALL RIGHTS RESERVED.

LOC	DIST	REVISIONS					
		P	LTN	DESCRIPTION	DATE	DWN	APVD
ES	00	-	-	SEE SHEET 1	-	-	-

DIM U	DIM T	DIM S	DIM R	DIM W	DIM D	DIM M	DIM L	DIM K	DESCRIPTION	PART NUMBER
2.650	.200	.250	1.550	.875	2.700	-	3.000	.450	2P + 24S + 6P	4-6450170-1
3.100	.250	.250	2.250	1.875	3.150	-	3.450	.450	6P + 12S + 4P	4-6450170-0
1.900	.250	.300	1.550	1.275	1.950	-	2.250	.475	3ACP + 8S + 2P	3-6450170-9
1.800	-	-	1.700	.625	1.850	-	2.150	.450	1P + 40S + 1P	3-6450170-8
1.600	-	-	1.500	.625	1.650	-	1.950	.450	1P + 32S + 1P	3-6450170-7
1.700	.250	.250	1.350	.875	1.750	-	2.050	.450	2P + 16S + 2P	3-6450170-6
1.550	.250	.250	1.200	.900	1.600	-	1.900	.450	2P + 8S + 2P	3-6450170-5
2.350	.250	.250	1.250	.875	2.400	-	2.700	.450	2P + 12S + 5P	3-6450170-4
2.325	.250	.300	1.975	1.600	2.375	-	2.675	.450	4ACP + 12S + 2P	3-6450170-3
1.700	.250	.250	1.350	.875	1.750	-	2.050	.450	2P + 16S + 2P	3-6450170-1
2.300	.250	.300	1.950	1.275	2.350	-	2.650	.450	3ACP + 24S + 2P	3-6450170-0
2.400	.250	.250	1.800	1.125	2.450	-	2.750	.450	3P + 24S + 3P	2-6450170-9
2.300	.250	.300	1.950	1.275	2.350	-	2.650	.450	3ACP + 24S + 2P	2-6450170-8
2.400	.250	.250	1.800	1.125	2.450	-	2.750	.450	3P + 24S + 3P	2-6450170-7
1.950	.250	.250	1.600	1.125	2.000	-	2.300	.450	3P + 16S + 2P	2-6450170-6
1.300	-	-	1.200	.675	1.350	-	1.650	.450	1P + 16S + 1P	2-6450170-0
2.200	.250	.250	1.350	.875	2.250	-	2.550	.450	2P + 16S + 4P	1-6450170-9
2.800	.300	.250	2.075	1.375	2.850	-	3.150	.450	4P + 24S + 3ACP	1-6450170-8
3.000	.250	.250	2.150	1.425	3.050	-	3.350	.450	4P + 24S + 4P	1-6450170-4
2.600	.200	.200	1.925	1.175	2.650	-	2.950	.425	4P + 28S + 4P	1-6450170-1
1.575	-	-	1.425	.700	1.625	-	1.925	.475	1P + 24S + 1P	1-6450170-0
2.500	.250	.250	2.150	.875	2.550	-	2.850	.450	2P + 48S + 2P	6450170-9
3.300	.250	.300	1.950	1.275	3.350	-	3.650	.475	3ACP + 24S + 6P	6450170-8
1.400	.250	.250	1.300	.625	1.450	-	1.750	.450	1P + 24S + 1P	6450170-6
2.400	.250	.250	1.800	1.125	2.450	-	2.750	.450	3P + 24S + 3P	6450170-5
4.350	.250	.250	3.500	2.625	4.400	-	4.700	.450	9P + 32S + 4P	6450170-4
3.650	.250	.300	2.550	1.275	3.700	-	4.000	.475	3ACP + 48S + 5P	6450170-3
3.050	.250	.300	1.950	1.275	3.100	-	3.400	.475	3ACP + 24S + 5P	6450170-2
2.550	.250	.300	2.200	1.525	2.600	-	2.900	.475	3ACP + 1P + 24S + 2P	6450170-1

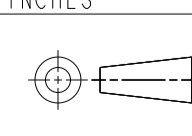
THIS DRAWING IS A CONTROLLED DOCUMENT.		DWN R. GRZYBOWSKI CHK M. PERCHERKE	Z1FEB05 Z1FEB05	 TE Connectivity NAME RIGHT ANGLE RECEPTACLE ASSEMBLY WITH GUIDES MULTI-BEAM XL
DIMENSIONS: INCHES	TOLERANCES UNLESS OTHERWISE SPECIFIED:	APVD M. PERCHERKE	PRODUCT SPEC 108-1973	
	0 PLC ±. 1 PLC ±.01 2 PLC ±.01 3 PLC ±.005 4 PLC ±.002 ANGLES ±.020 FINISH	APPLICATION SPEC 114-13038	RESTRICTED TO	
MATERIAL		WEIGHT	SIZE A100779	
		CUSTOMER DRAWING	SCALE 4:1 SHEET 2 OF 13 REV J5	

NO CONTACT

PART NUMBER	ROWS	POWER				SIGNAL				POWER								
		P6	P5	P4	P3	6	5	4	3	2	1	P4	P3	P2	P1			
6450170-1	D C B A	RM	RM	RM	RM	H	H	H	H	H	H	H	H	H	H	RA	RM	RM
		3ACP + 1P + 24S + 2P																

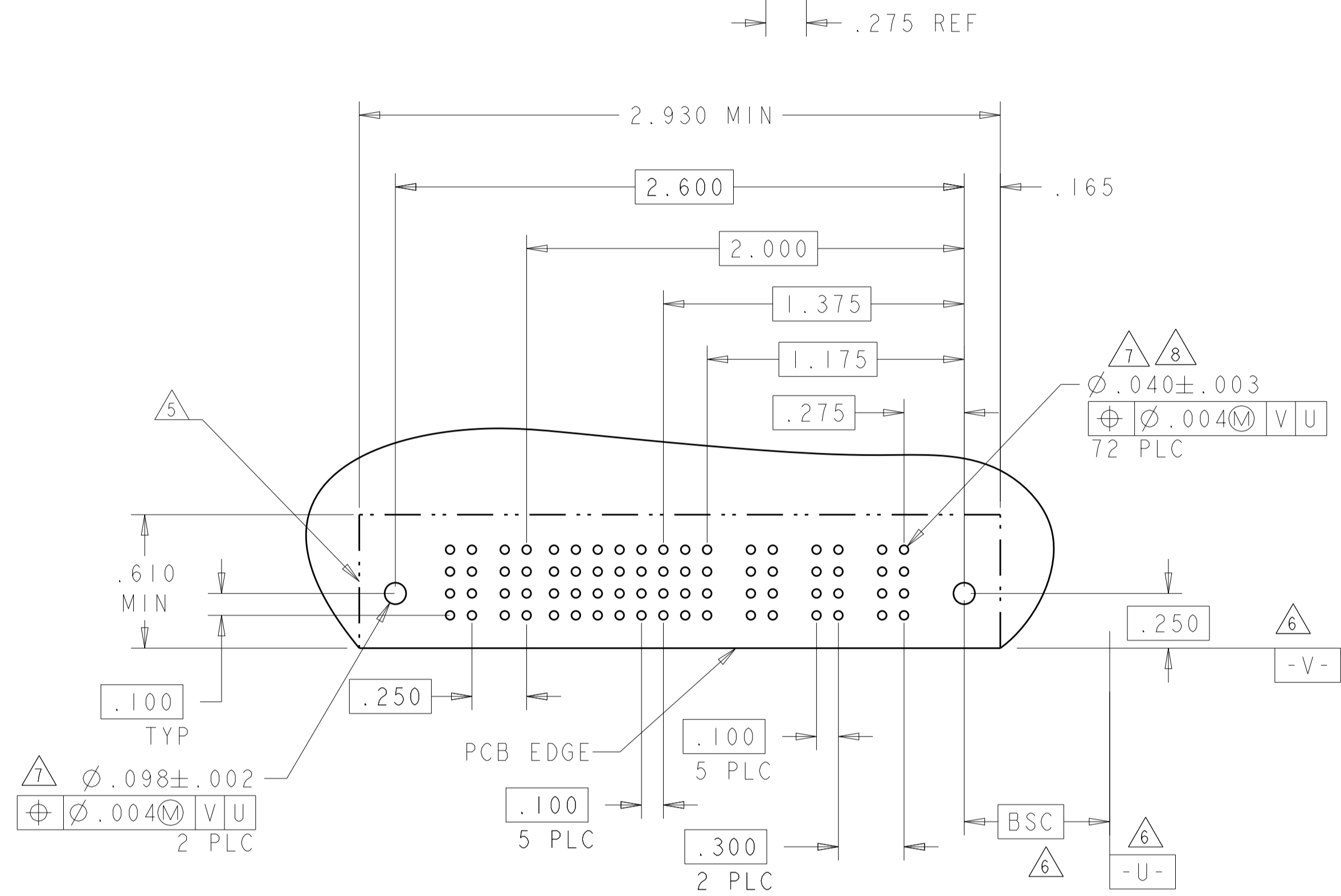

PART NUMBER	ROWS	POWER				SIGNAL				POWER								
		P8	P7	P6	P5	P4	6	5	4	3	2	1	P3	P2	P1			
6450170-2	D C B A	RM	RM	RM	RM	H	H	H	H	H	H	H	H	H	H	RA	RM	RM
		3ACP + 24S + 5P																

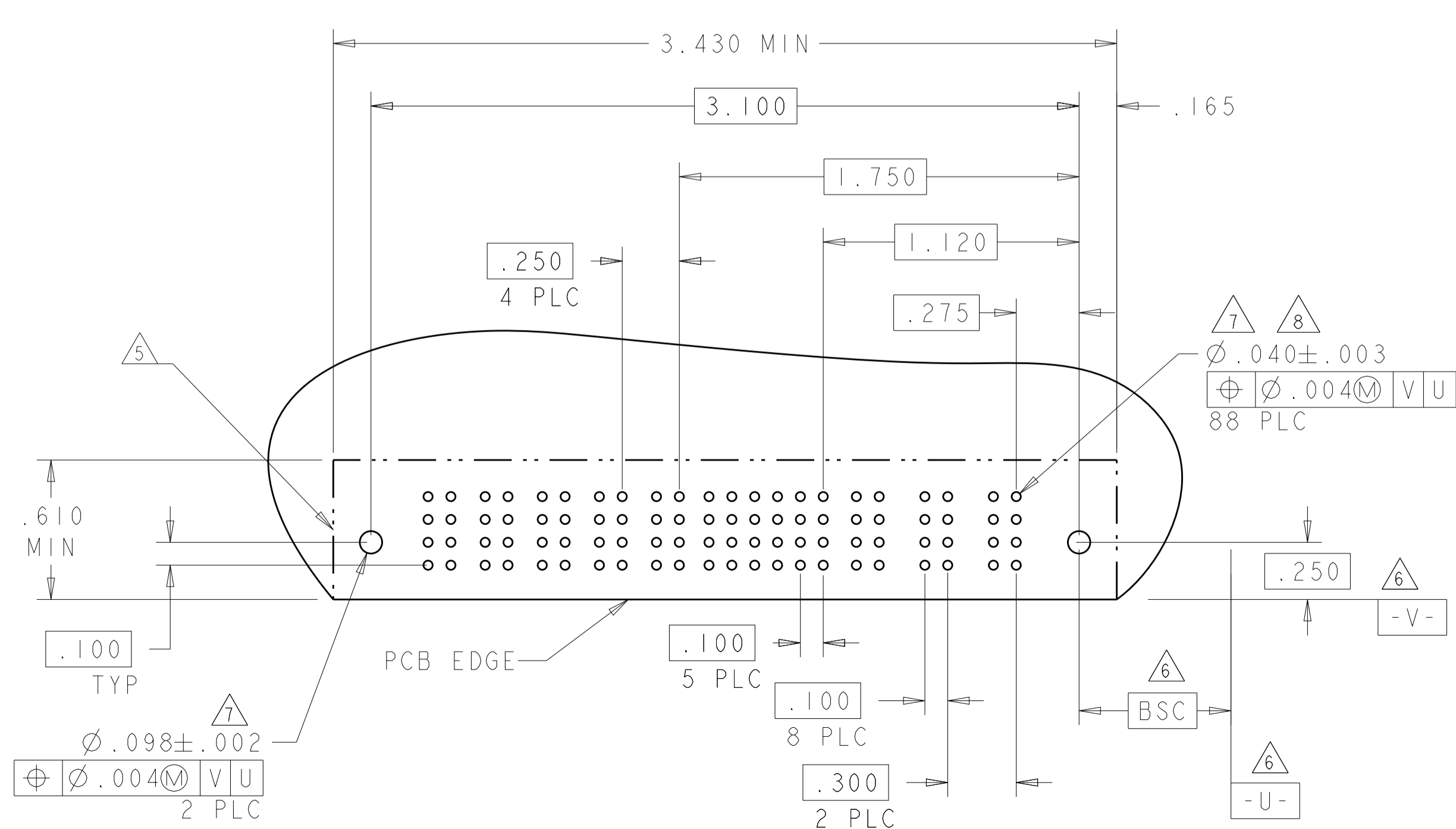

PART NUMBER	ROWS	POWER				SIGNAL												POWER					
		P8	P7	P6	P5	12	11	10	9	8	7	6	5	4	3	2	1	P3	P2	P1			
6450170-3	D C B A	RM	RM	RM	RM	H	H	H	H	H	H	H	H	H	H	H	H	H	H	H	RA	RM	RM
		3ACP + 48S + 5P																					

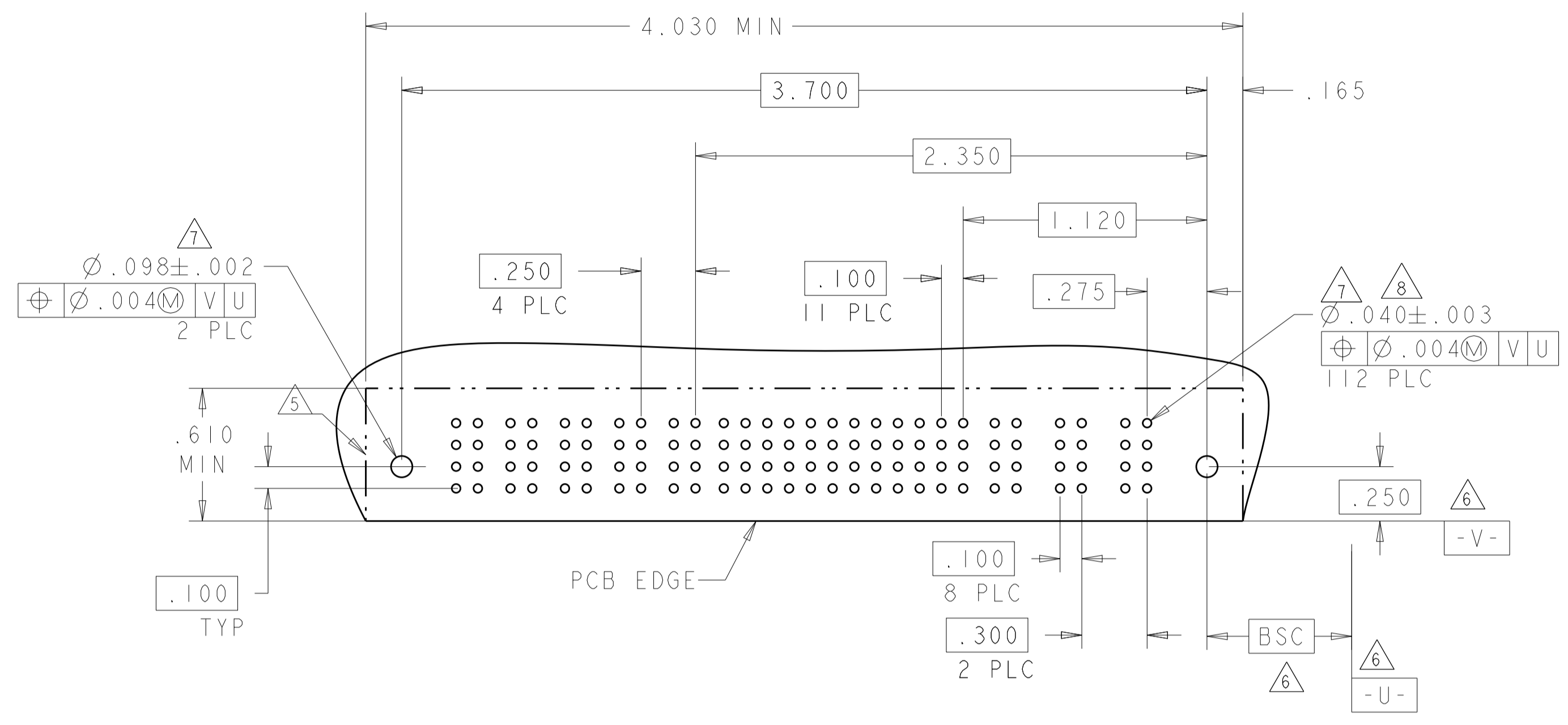

NO CONTACT

PART NUMBER	ROWS	POWER				SIGNAL												POWER							
		P13	P12	P11	P10	8	7	6	5	4	3	2	1	P9	P8	P7	P6	P5	P4	P3	P2	P1			
6450170-4	D C B A	RM	RM	RA	RM	H	H	H	H	H	H	H	H	H	H	H	H	H	H	H	H	H	RA	RM	RM
		J ² 1 3c3 1 4P																							

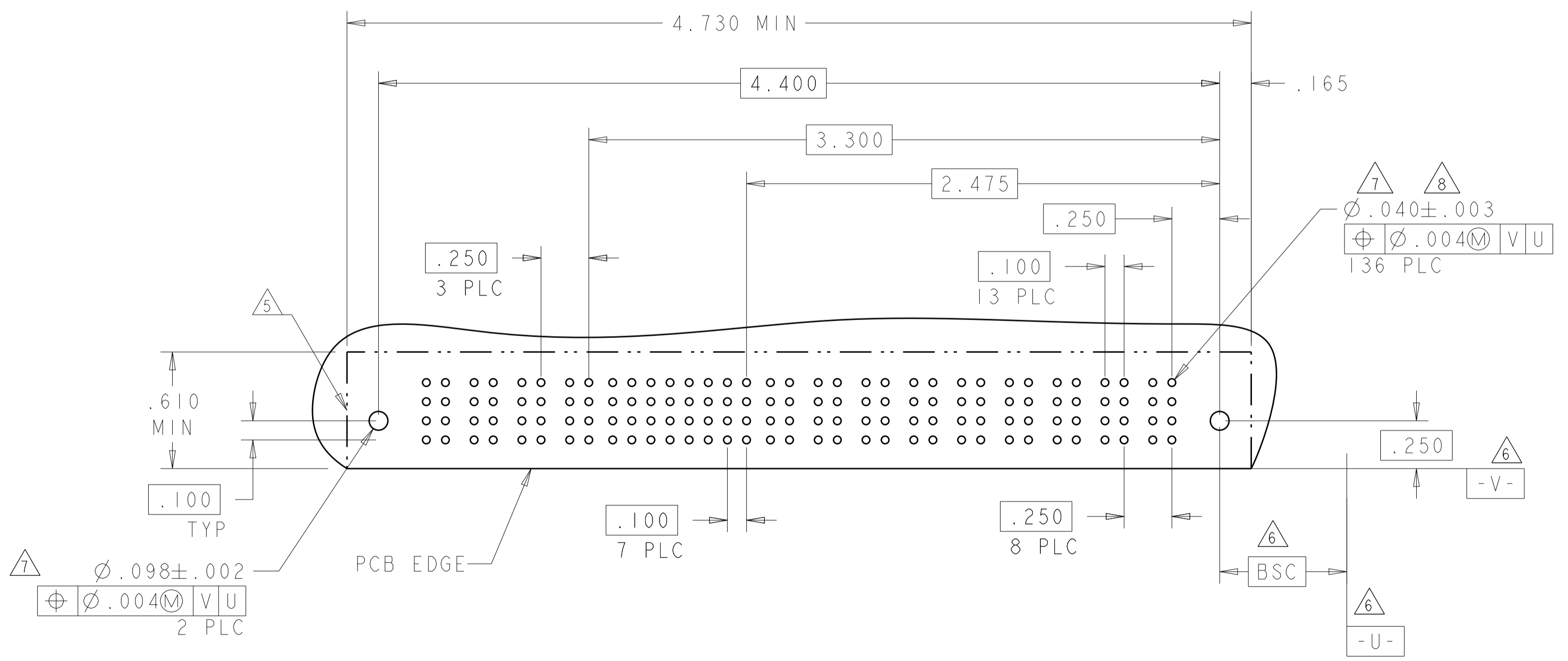

CODE	TAIL LENGTH	TYPE	CODE	TAIL LENGTH	ROW
RM	.135	STD	F	.135	B
RA	.135	MFBL	E	.135	A

THIS DRAWING IS A CONTROLLED DOCUMENT.

DIMENSIONS: INCHES	TOLERANCES UNLESS OTHERWISE SPECIFIED:	OWN: R. GRZYBOWSKI	21FEB05
0 PLC ±.01	1 PLC ±.01	CHK: M. PERCHERKE	21FEB05
2 PLC ±.01	3 PLC ±.01	APV: M. PERCHERKE	
4 PLC ±.002	5 PLC ±.005	PRODUCT SPEC	
ANGLES ±.020		108-1973	
		APPLICATION SPEC	
		114-13038	
		WEIGHT	
		FINISH	

NAME: RIGHT ANGLE RECEPTACLE ASSEMBLY WITH GUIDES MULTI-BEAM XL

SIZE: A1 CAGE CODE: DRAWING NO: 100779 ©=6450170

RESTRICTED TO: -

CUSTOMER DRAWING SCALE: 1:1 SHEET 3 OF 13 REV J5

LOC	DIST	REVISIONS			
ES	00	REV	DATE	BY	APPROV
		1			
		SEE SHEET 1			

PART NUMBER	ROWS	POWER			SIGNAL					POWER				
		P6	P5	P4	6	5	4	3	2	1	P3	P2	P1	
6450170-5	D C B A	RA	RM	RM	H	H	H	H	H	H	H	RM	RM	RA
					G	G	G	G	G	G	G			
					F	F	F	F	F	F	F			
					E	E	E	E	E	E	E			

3P + 24S + 3P

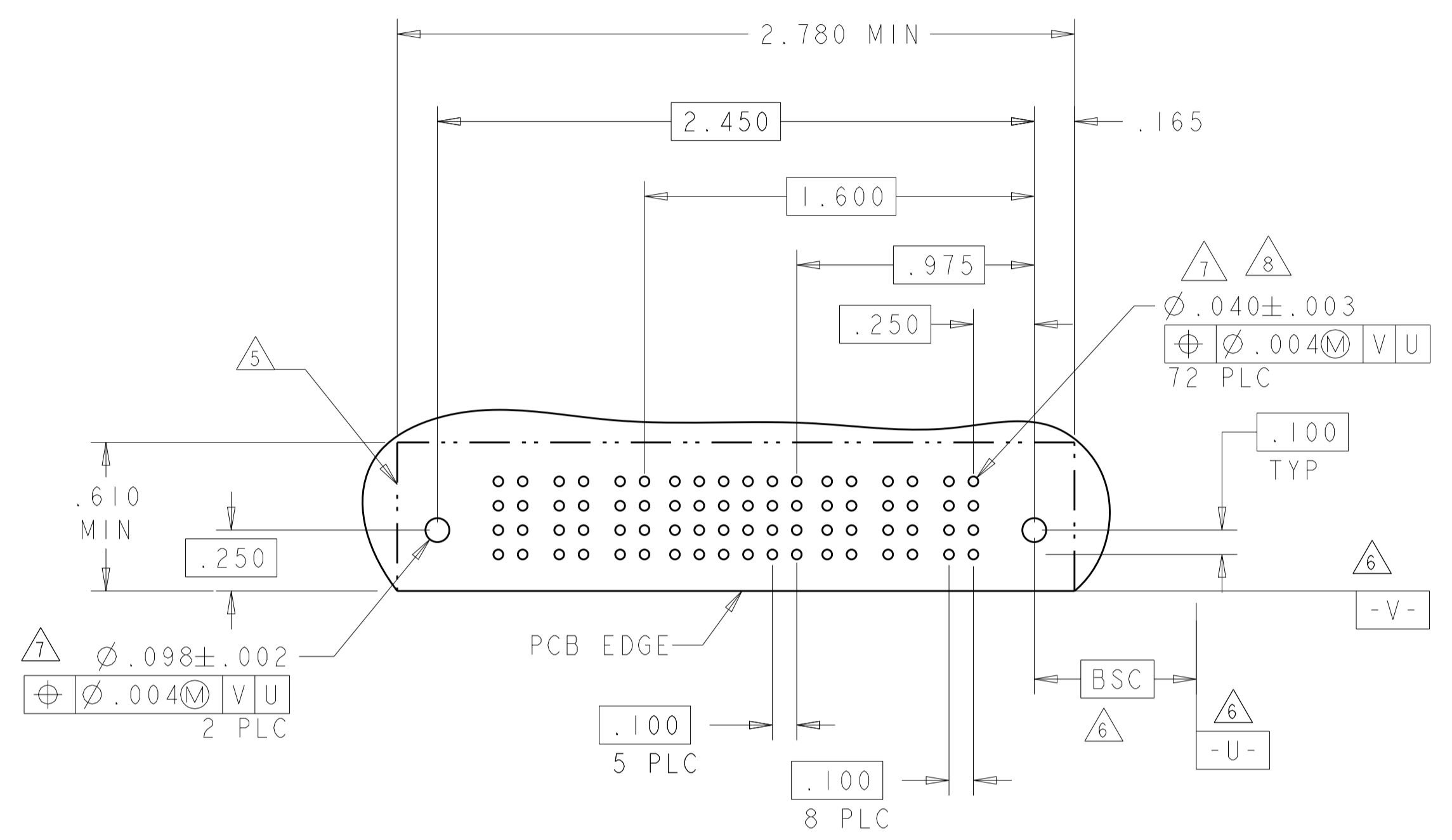

PART NUMBER	ROWS	POWER		SIGNAL					POWER			
		P2	P1	6	5	4	3	2	1	P2	P1	
6450170-6	D C B A	RB	RA	L	L	L	L	L	L	L	RM	RA
				K	K	K	K	K	K	K		
				J	J	J	J	J	J	J		
				I	I	I	I	I	I	I		

1P + 24S + 1P

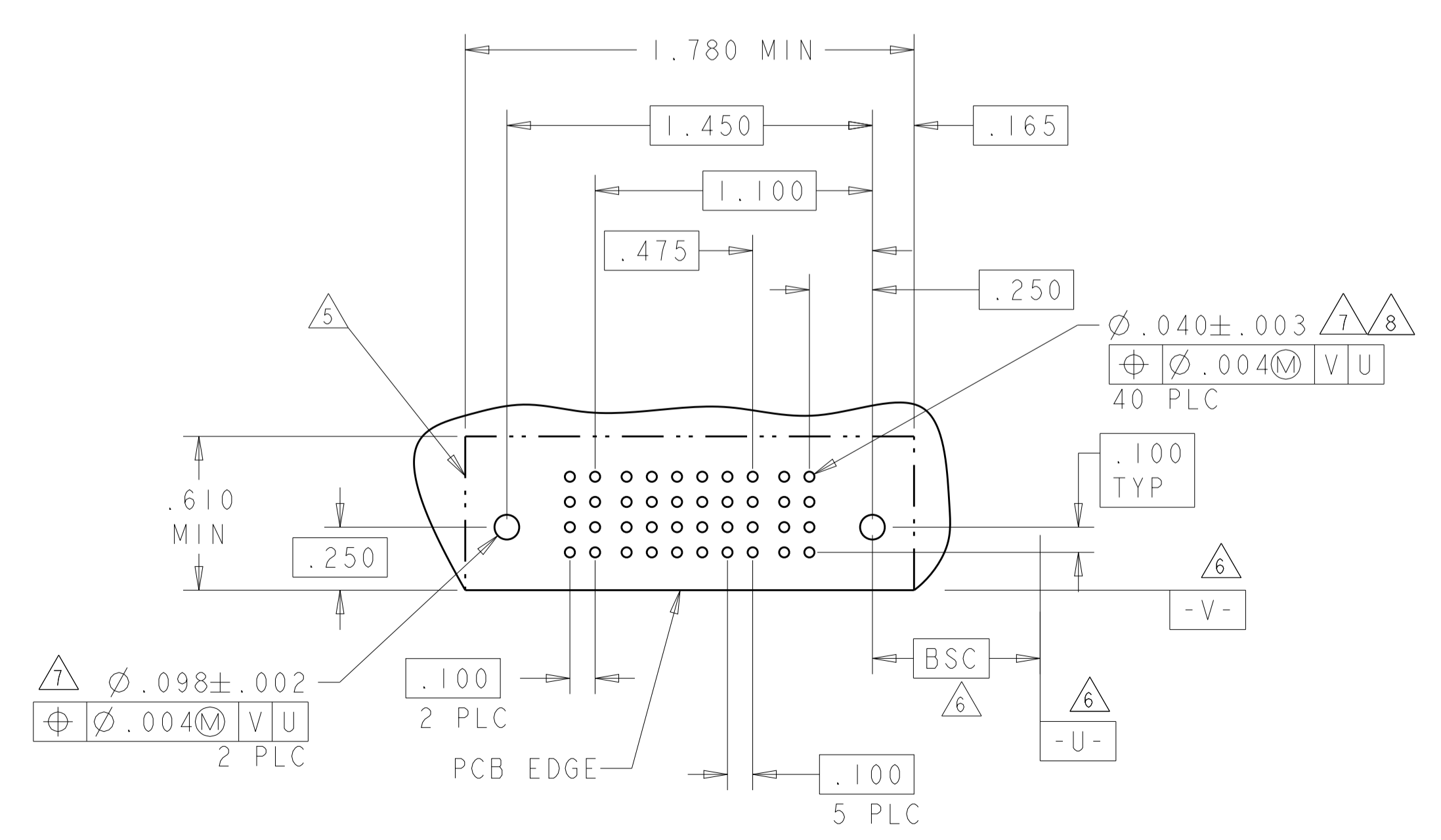

PART NUMBER	ROWS	POWER					SIGNAL					POWER			
		P9	P8	P7	P6	P5	6	5	4	3	2	1	P3	P2	P1
6450170-8	D C B A	RM	RM	RM	RM	RM	H	H	H	H	H	H	RA	RM	RM
							G	G	G	G	G	G			
							F	F	F	F	F	F			
							E	E	E	E	E	E			

3ACP + 24S + 6P

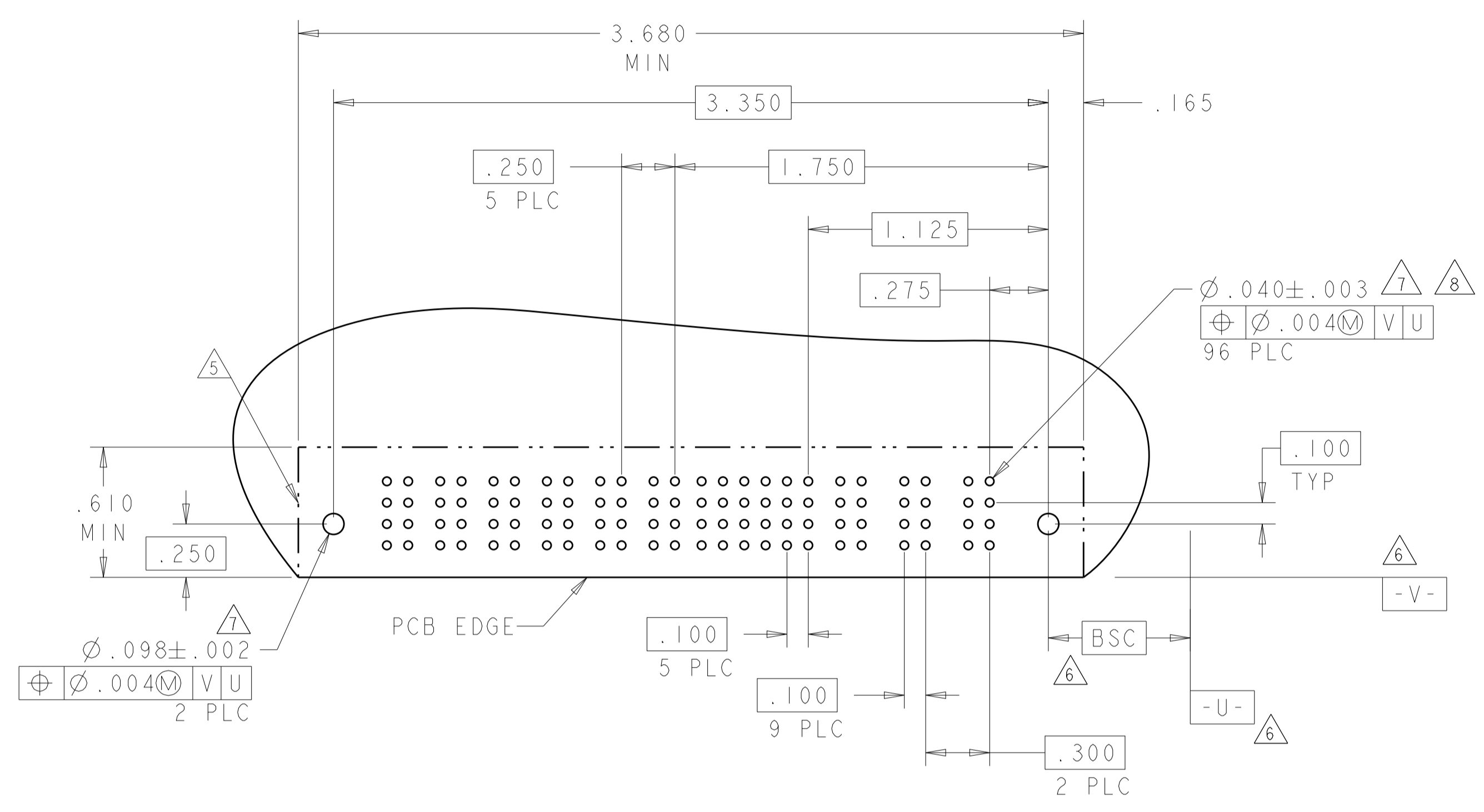

PART NUMBER	ROWS	POWER		SIGNAL										POWER			
		P4	P3	12	11	10	9	8	7	6	5	4	3	2	1	P2	P1
6450170-9	D C B A	RM	RA	H	H	H	H	H	H	H	H	H	H	H	H	RM	RA
				G	G	G	G	G	G	G	G	G	G	G	G		
				F	F	F	F	F	F	F	F	F	F	F	F		
				E	E	E	E	E	E	E	E	E	E	E	E		

2P + 48S + 2P

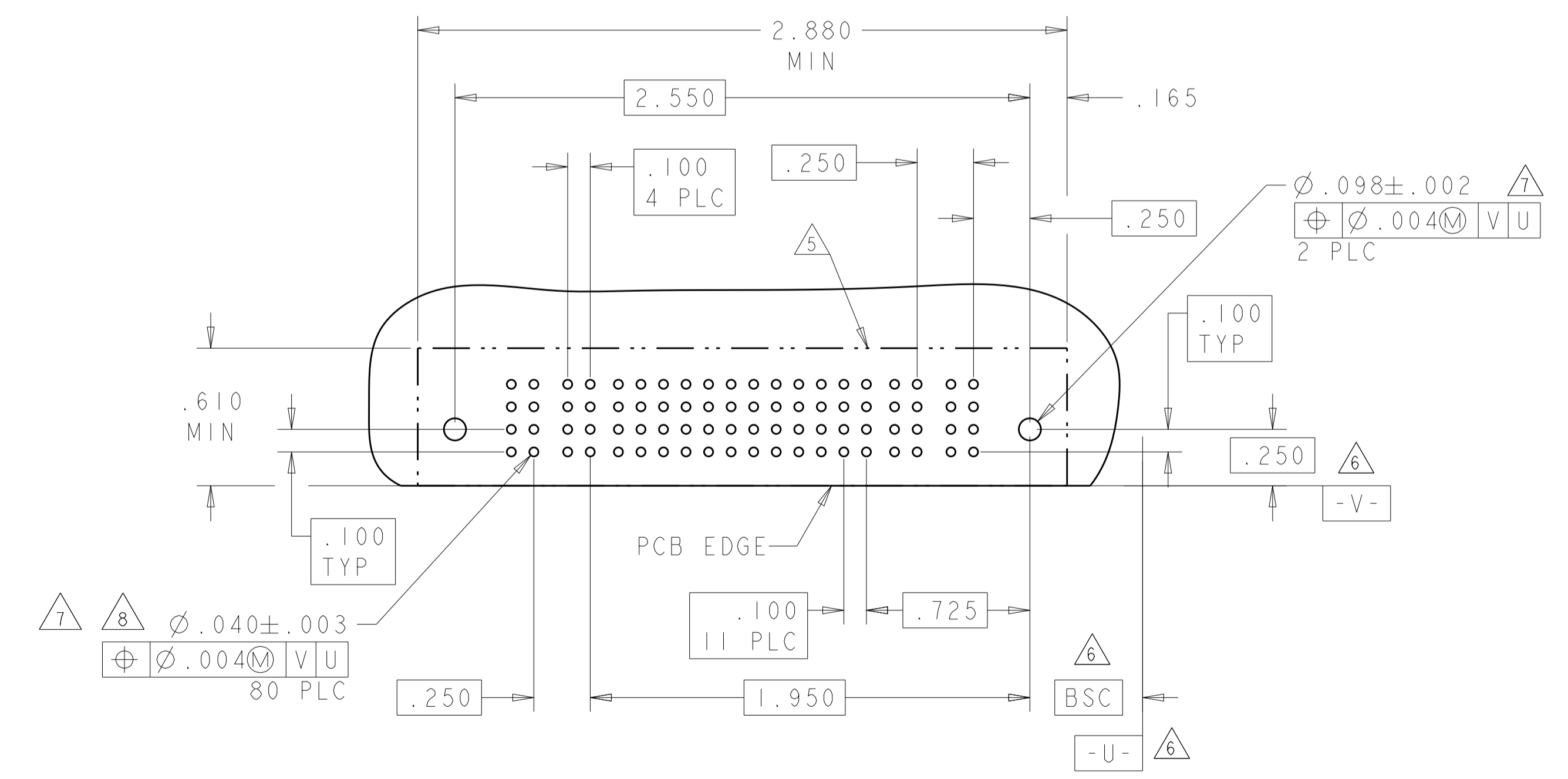

THIS DRAWING IS A CONTROLLED DOCUMENT.

DIMENSIONS:	TOLERANCES UNLESS OTHERWISE SPECIFIED:	DRN: R. GRZYBOWSKI	21FEB05
INCHES	0 PLC ±.01	CHK: M. PERCHERKE	21FEB05
	1 PLC ±.01	APVD: M. PERCHERKE	
	2 PLC ±.01	NAME: M. PERCHERKE	
	3 PLC ±.01	PRODUCT SPEC: 108-1973	
	4 PLC ±.005	APPLICATION SPEC: 114-13038	
	5 PLC ±.002	WEIGHT: -	
	ANGLES ±.002	CUSTOMER DRAWING	

RIGHT ANGLE RECEPTACLE ASSEMBLY WITH GUIDES MULTI-BEAM XL

SCALE: 4:1 SHEET 4 OF 13 REV J5

LOC	DIST	REVISIONS			
ES	00	REV	DATE	BY	APPV
		1	SEE SHEET 1		

PART NUMBER	ROWS	POWER						SIGNAL						POWER						
		P2	6	5	4	3	2	1	P1	6	5	4	3	2	1	P3	P2	P1		
1-6450170-0	D C B A	RM	H	H	H	H	H	H	RA	RA	RA	RA	RA	RA	RA	RA	RA	HD	HD	HD
		RM	G	G	G	G	G	G	RA	RA	RA	RA	RA	RA	RA	RA	RA	HD	HD	HD
		RM	F	F	F	F	F	F	RA	RA	RA	RA	RA	RA	RA	RA	RA	HD	HD	HD
		RM	E	E	E	E	E	E	RA	RA	RA	RA	RA	RA	RA	RA	RA	HD	HD	HD

IP + 24S + IP

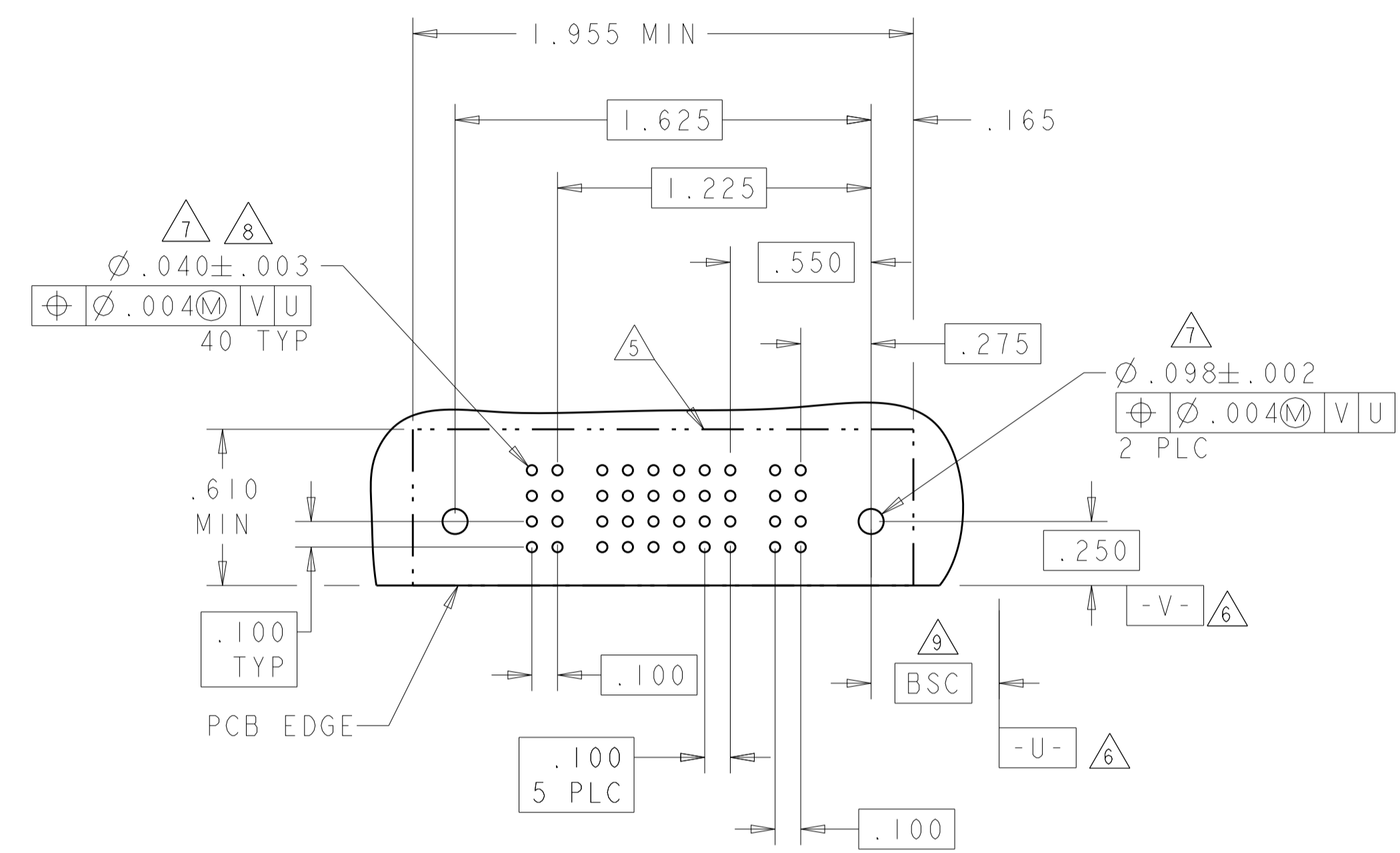

PART NUMBER	ROWS	POWER								SIGNAL								POWER				
		P8	P7	P6	P5	7	6	5	4	3	2	1	P4	P3	P2	P1	P3	P2	P1			
1-6450170-1	D C B A	RM	RM	RM	RM	H	H	H	H	H	H	H	RA	RA	RA	RA	RA	RA	RA	HD	HD	HD
		RM	RM	RM	RM	G	G	G	G	G	G	G	RA	RA	RA	RA	RA	RA	RA	HD	HD	HD
		RM	RM	RM	RM	F	F	F	F	F	F	F	RA	RA	RA	RA	RA	RA	RA	HD	HD	HD
		RM	RM	RM	RM	E	E	E	E	E	E	E	RA	RA	RA	RA	RA	RA	RA	HD	HD	HD

4P + 28S + 4P

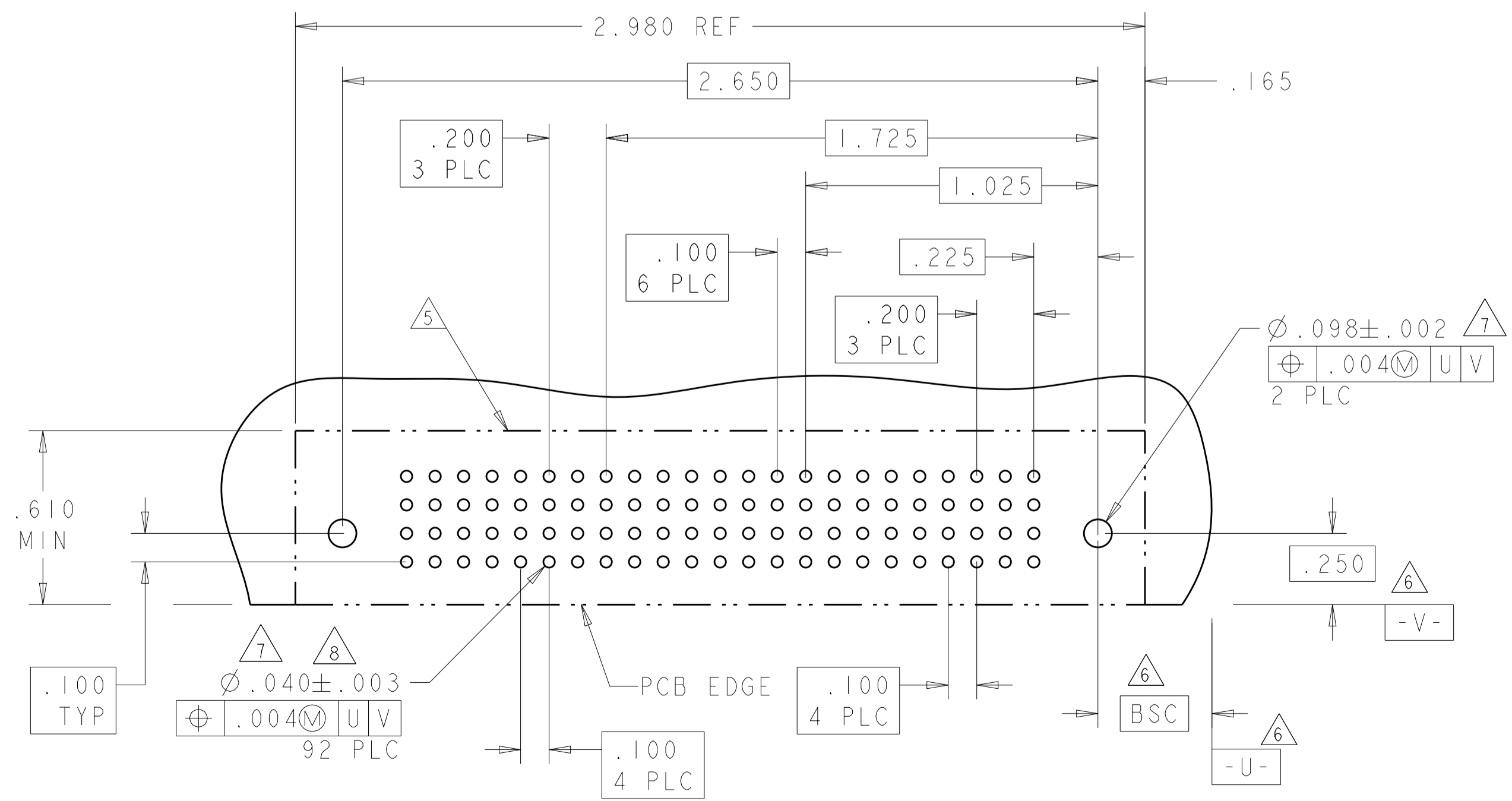

PART NUMBER	ROWS	POWER				SIGNAL				POWER						
		P5	P4	4	3	2	1	P3	P2	P1	P3	P2	P1			
2-6450170-6	D C B A	RM	RM	H	H	H	H	RA	RA	RA	RA	RA	RA	HD	HD	HD
		RM	RM	G	G	G	G	RA	RA	RA	RA	RA	RA	HD	HD	HD
		RM	RM	F	F	F	F	RA	RA	RA	RA	RA	RA	HD	HD	HD
		RM	RM	E	E	E	E	RA	RA	RA	RA	RA	RA	HD	HD	HD

3P + 16S + 2P

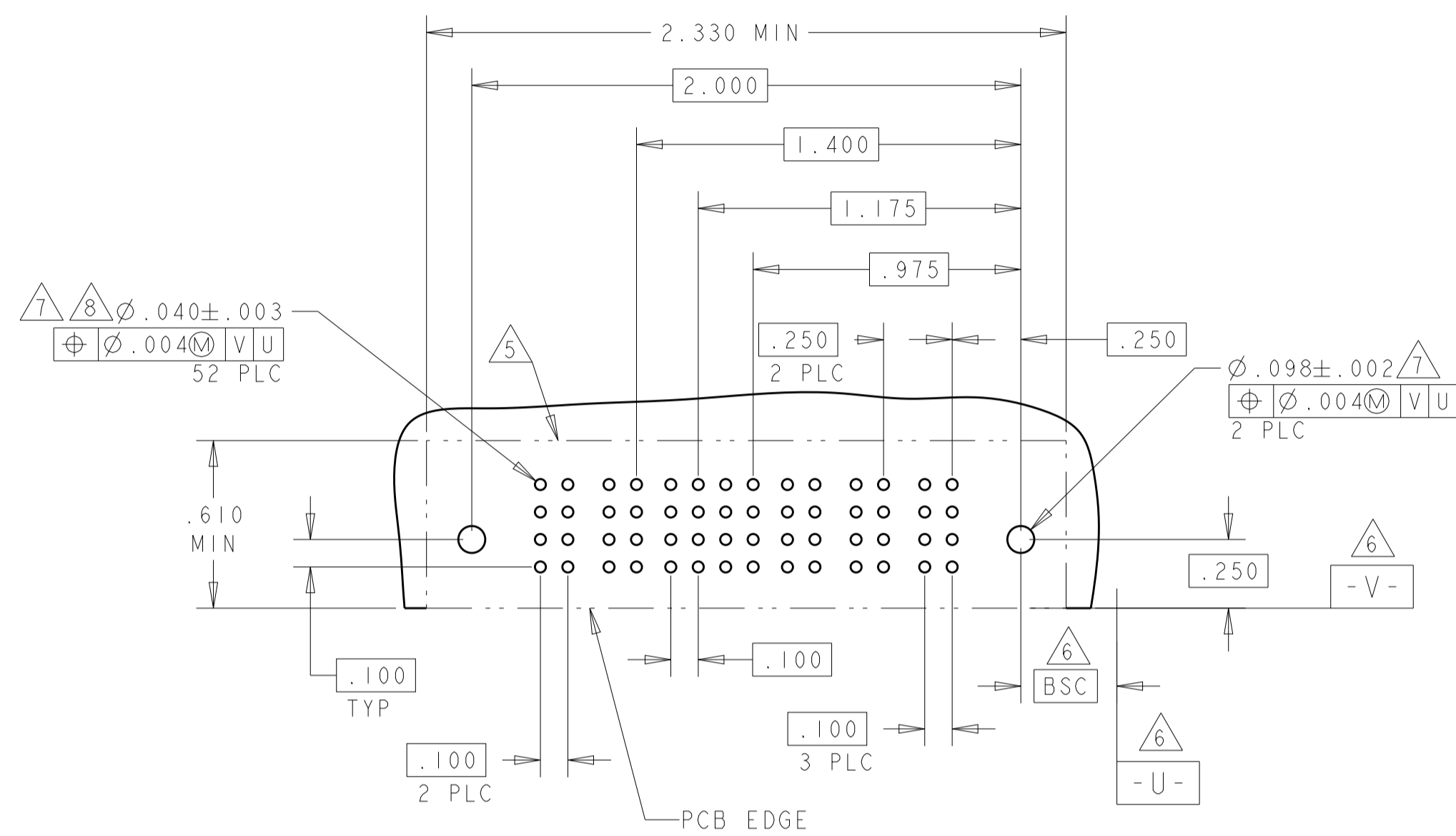

PART NUMBER	ROWS	POWER						SIGNAL						POWER			
		P6	P5	P4	6	5	4	3	2	1	P3	P2	P1	P3	P2	P1	
2-6450170-7	D C B A	RM	RM	RA	H	H	H	H	RM	RM	RM	RM	RM	RM	HD	HD	HD
		RM	RM	RA	G	G	G	G	RM	RM	RM	RM	RM	RM	HD	HD	HD
		RM	RM	RA	F	F	F	F	RM	RM	RM	RM	RM	RM	HD	HD	HD
		RM	RM	RA	E	E	E	E	RM	RM	RM	RM	RM	RM	HD	HD	HD

3P + 24S + 3P

PART NUMBER	ROWS	POWER						SIGNAL						POWER			
		P6	P5	P4	6	5	4	3	2	1	P3	P2	P1	P3	P2	P1	
2-6450170-9	D C B A	RM	RM	RA	H	H	H	H	RM	RM	RM	RM	RM	RM	HD	HD	HD
		RM	RM	RA	G	G	G	G	RM	RM	RM	RM	RM	RM	HD	HD	HD
		RM	RM	RA	F	F	F	F	RM	RM	RM	RM	RM	RM	HD	HD	HD
		RM	RM	RA	E	E	E	E	RM	RM	RM	RM	RM	RM	HD	HD	HD

3P + 24S + 3P

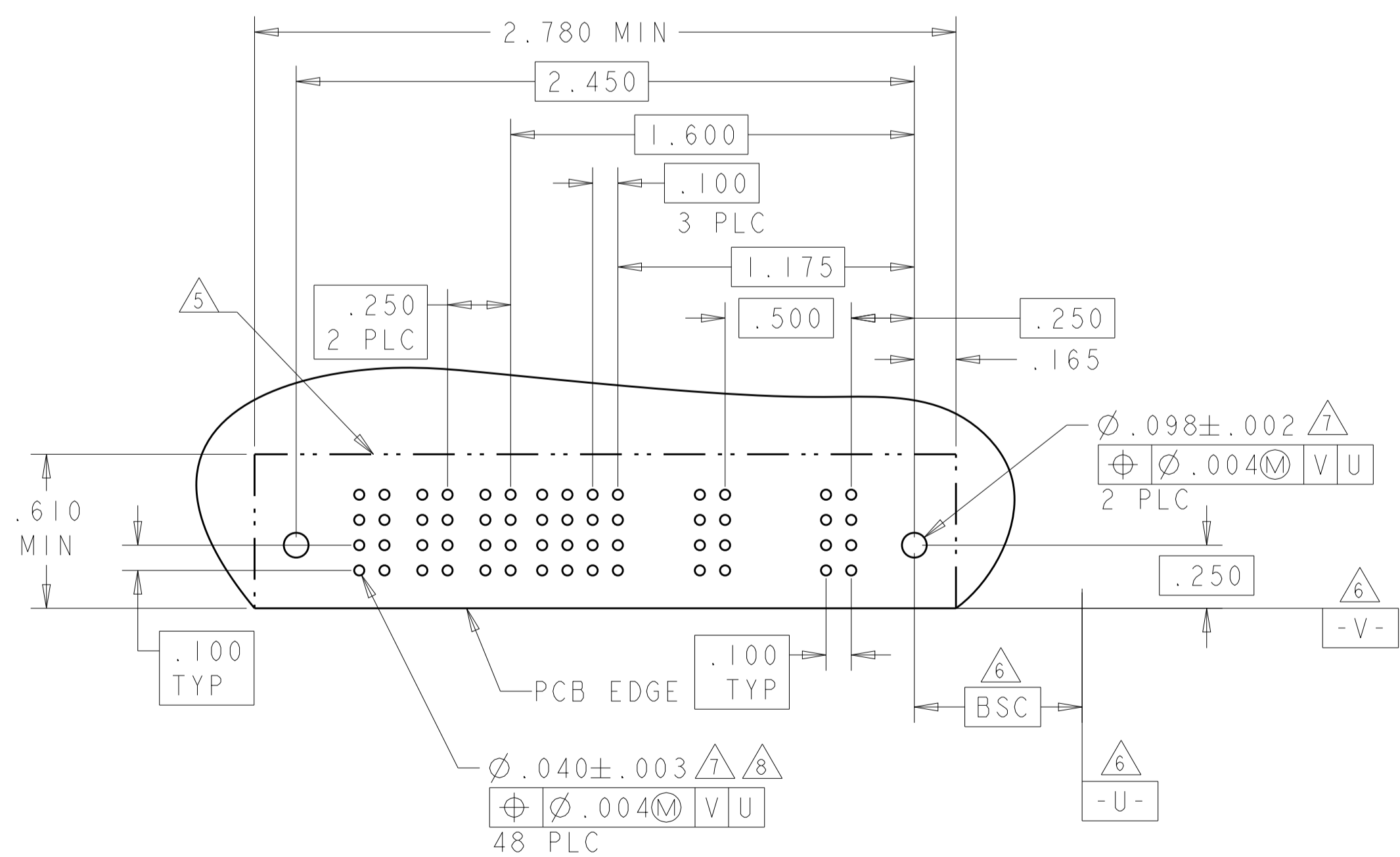

2-6450170-7 & 2-6450170-9 PCB LAYOUT

THIS DRAWING IS A CONTROLLED DOCUMENT.		OWN: R. GRZYBOWSKI 21FEB05	 TE Connectivity
DIMENSIONS: INCHES		CHK: M. PERCHERKE	
TOLERANCES UNLESS OTHERWISE SPECIFIED:		APVD: M. PERCHERKE	NAME: RIGHT ANGLE RECEPTACLE ASSEMBLY WITH GUIDES MULTI-BEAM XL
0 PLC ±.01 1 PLC ±.01 2 PLC ±.01 3 PLC ±.005 4 PLC ±.002 ANGLES ±.020		PRODUCT SPEC: 108-1973	SIZE: CAGE CODE DRAWING NO: 114-13038
MATERIAL: FINISH:		APPLICATION SPEC: 114-13038	RESTRICTED TO: A100779C=6450170
		WEIGHT: 114-13038	CUSTOMER DRAWING: SCALE: 4:1 SHEET 5 OF 13 REV J5

LOC	DIST	REV	DATE	APP'D
ES	00			

REVISIONS				
NO.	DESCRIPTION	DATE	BY	APP'D
-	SEE SHEET 1	-	-	-

PART NUMBER	ROWS	POWER				SIGNAL				POWER	
		P6	P5	P4	P3	4	3	2	1	P2	P1
I-6450170-9	D C B A	RA	RA	RM	RM	H	H	H	H	RM	RA
						G	G	G	G		
						F	F	F	F		
		HD				HD					
2P + 16S + 4P											

PART NUMBER	ROWS	POWER				SIGNAL				POWER			
		P8	P7	P6	P5	6	5	4	3	2	1	P4	P3
I-6450170-4	D C B A	RA	RA	RA	RA	H	H	H	H	RA	RA	RA	RA
						G	G	G	G				
						F	F	F	F				
		HD				HD							
4P + 24S + 4P													

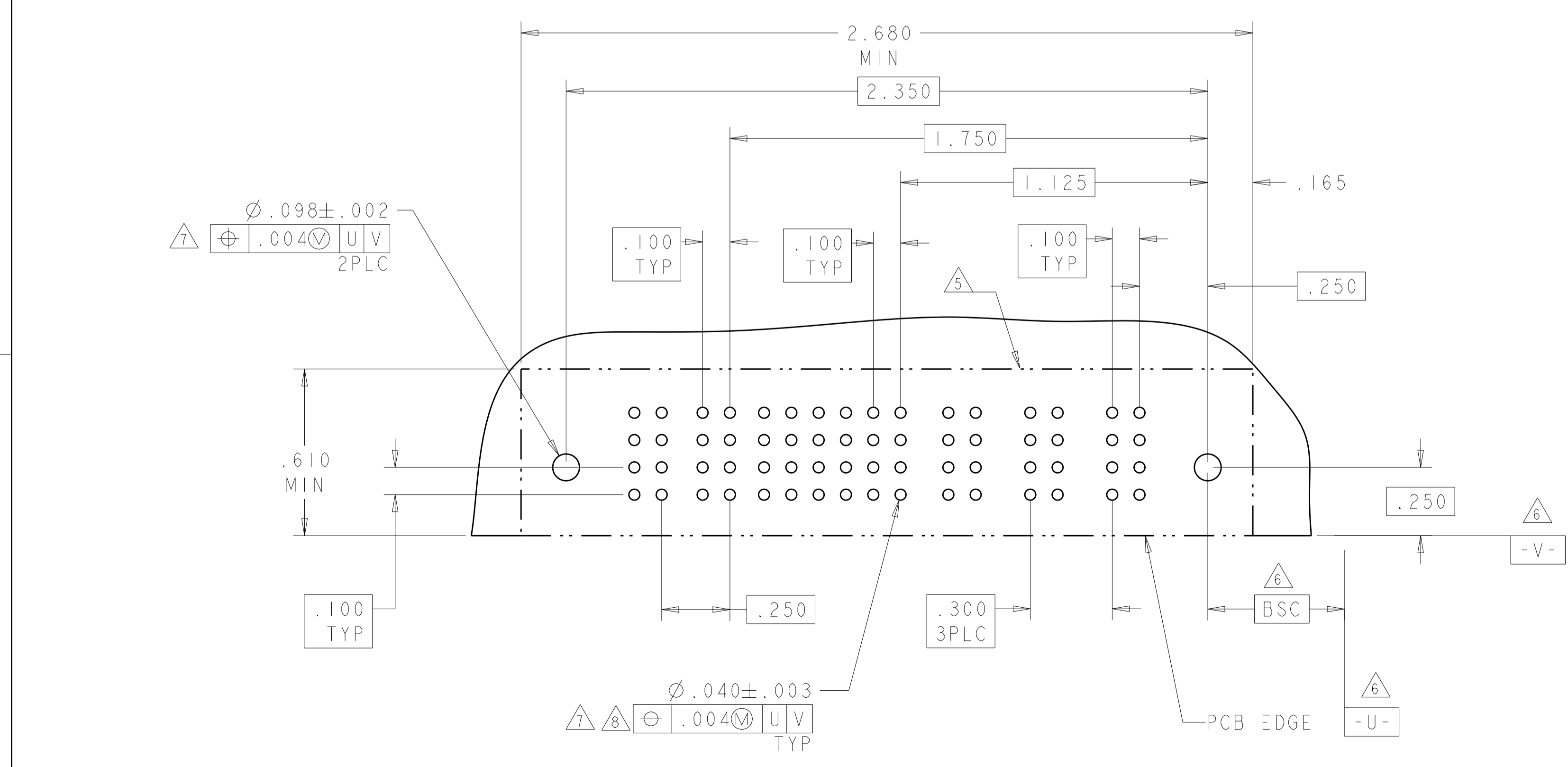
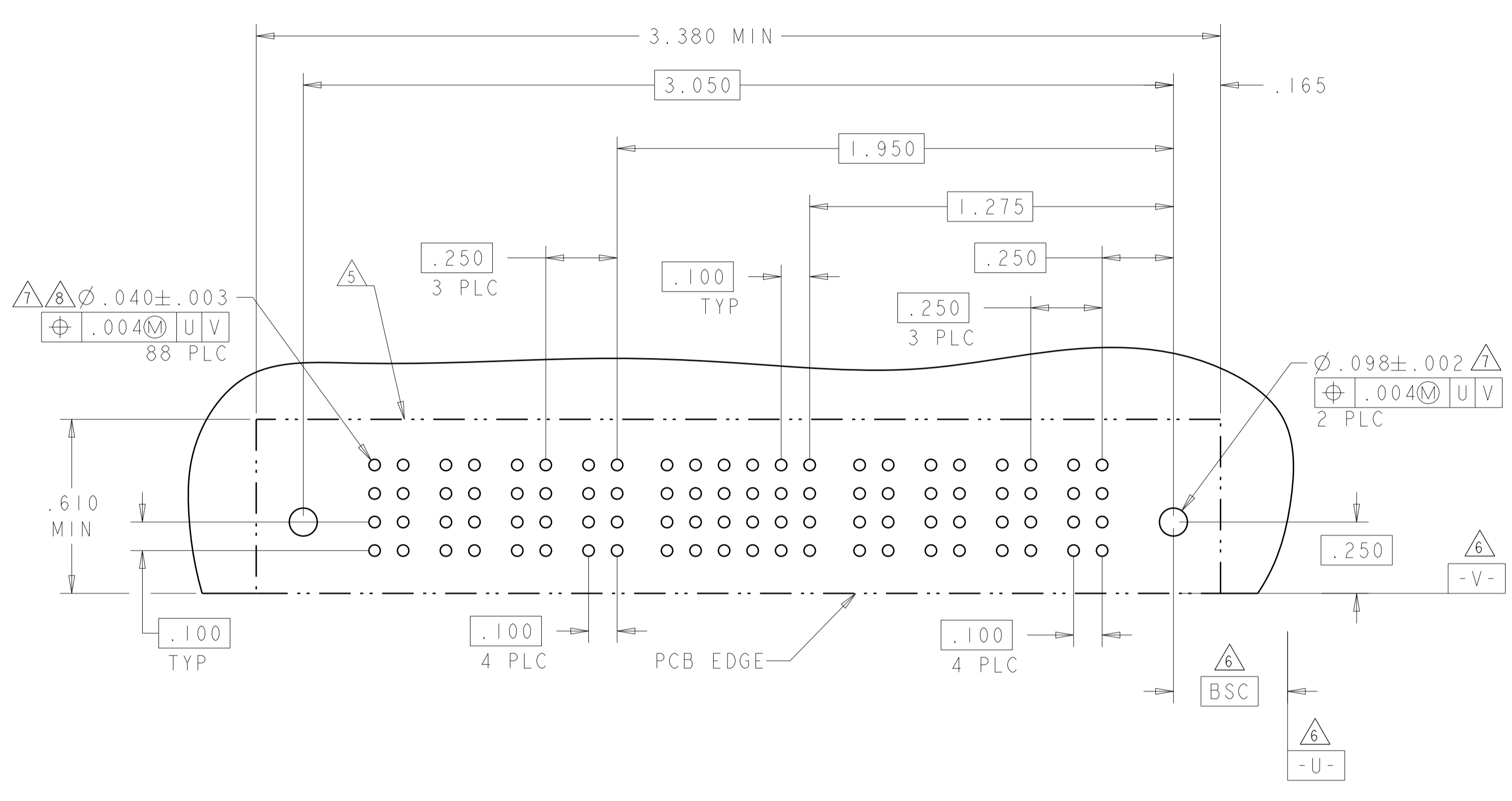
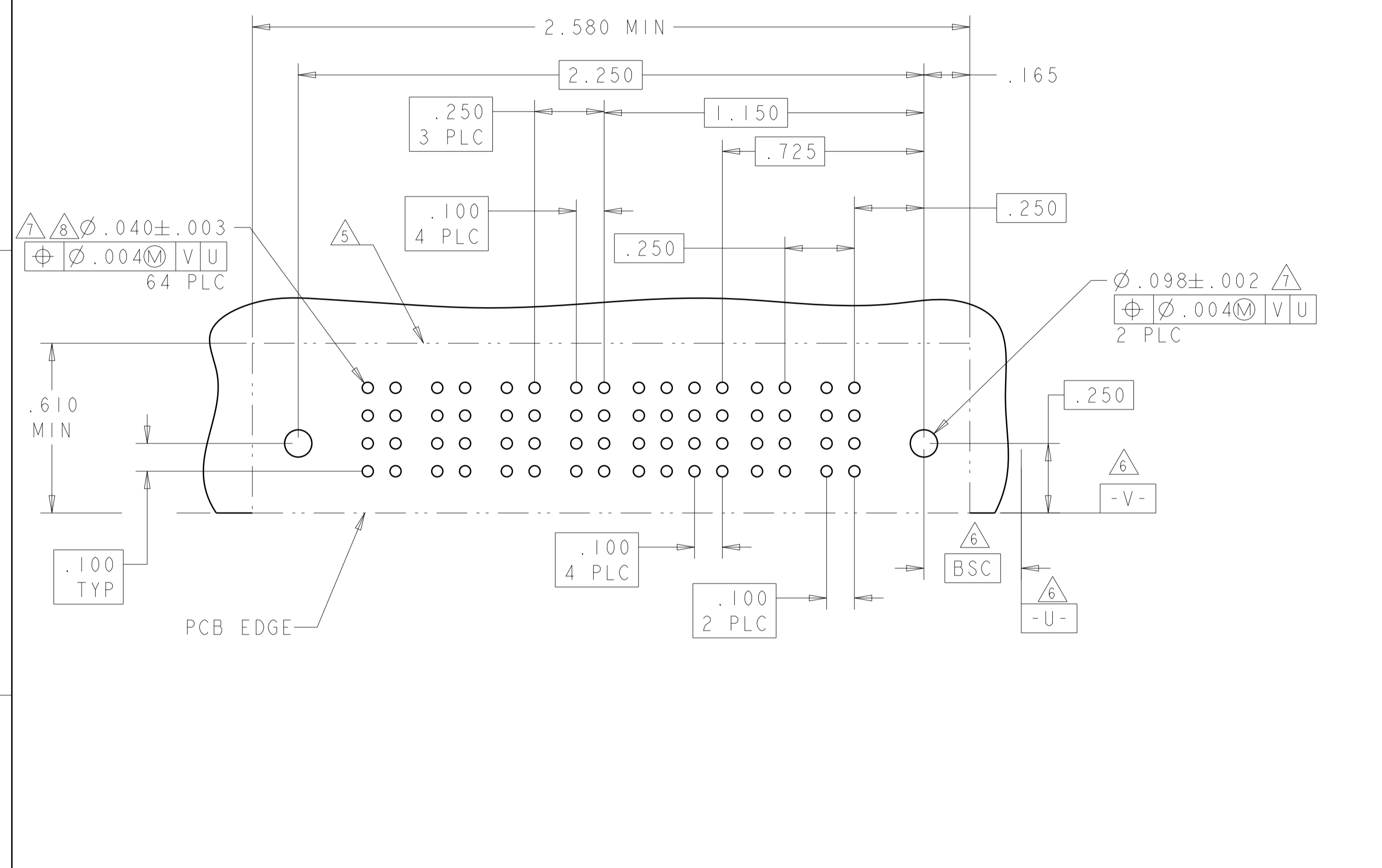

PART NUMBER	ROWS	POWER		SIGNAL						AC POWER		
		P5	P4	6	5	4	3	2	1	P3	P2	P1
2-6450170-8	D C B A	RA	RA	H	H	H	H	H	H	RA	RM	RM
				G	G	G	G	G	G			
				F	F	F	F	F	F			
		HD				HD						
3ACP + 24S + 2P												

THIS DRAWING IS A CONTROLLED DOCUMENT.

OWN: R. GRZYBOWSKI 21FEB05
CHK: M. PERCHERKE 21FEB05
APVD: M. PERCHERKE

TE Connectivity

NAME: RIGHT ANGLE RECEPTACLE ASSEMBLY WITH GUIDES MULTI-BEAM XL

PRODUCT SPEC: 108-1973
APPLICATION SPEC: 114-13038

SIZE: A1
CAGE CODE: 6450170
DRAWING NO: 100779

RESTRICTED TO: J5

SCALE: 4:1
SHEET: 6 OF 13
REV: J5

LOC	DIST	REVISIONS			
P	LTN	DESCRIPTION	DATE	OWN	APVD
ES	00	SEE SHEET 1	-	-	-

PART NUMBER	ROWS	POWER		SIGNAL				POWER		
		P2	P1	4	3	2	1	P1	P2	
2-6450170-0	D C B A	RM	RM	H	H	H	H	RM	RM	RM
				G	G	G	G			
				F	F	F	F			
IP + 16S + IP		HD		E E E E E E E E				HD		

PART NUMBER	ROWS	POWER		SIGNAL						AC POWER				
		P5	P4	6	5	4	3	2	1	P3	P2	P1		
3-6450170-0	D C B A	RM	RM	H	H	H	H	H	H	RM	RM	RM	RM	RM
				G	G	G	G	G	G					
				F	F	F	F	F	F					
3ACP + 24S + 2P		HD		E E E E E E E E E E E E E E E E E E						HD				

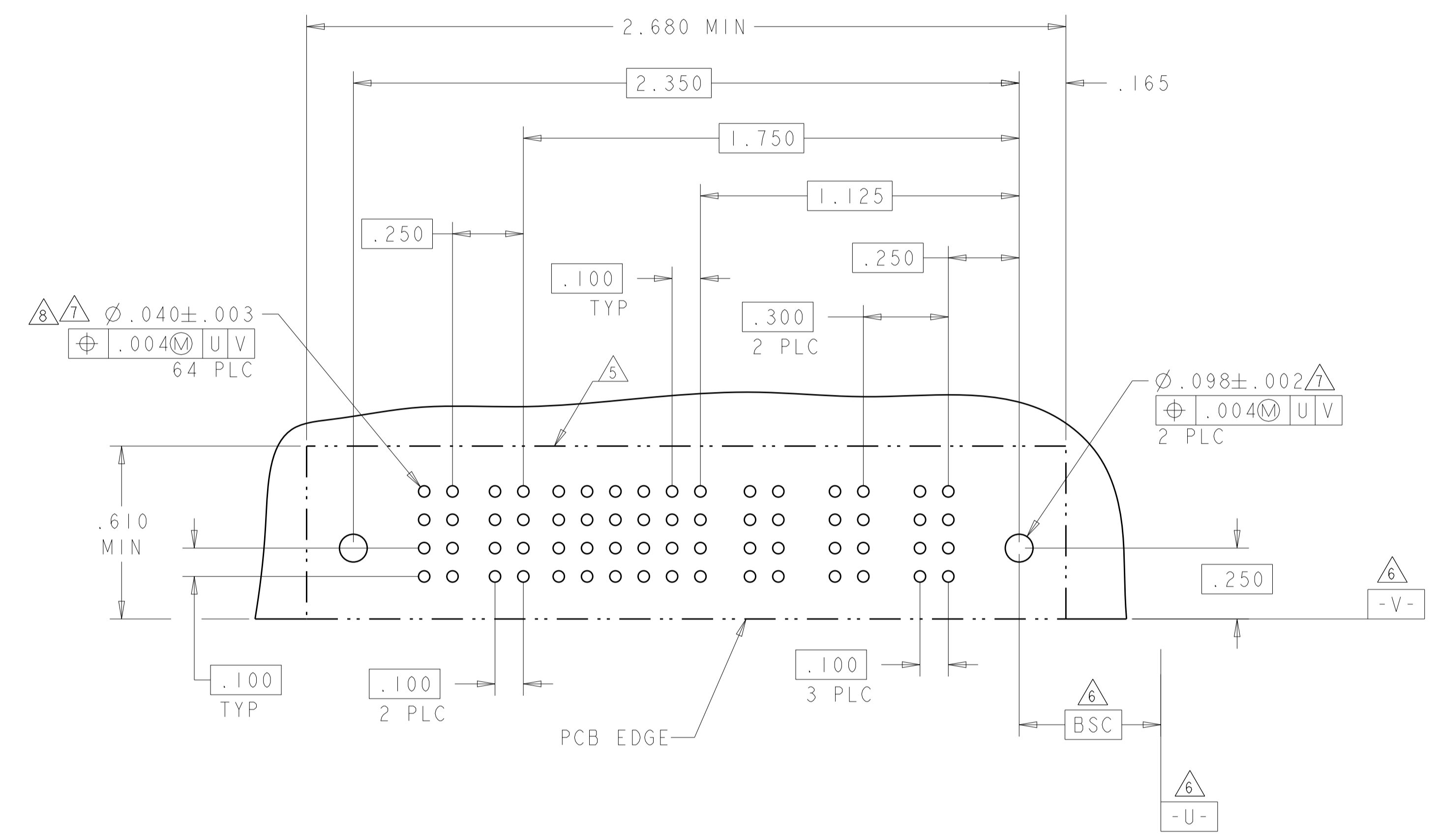
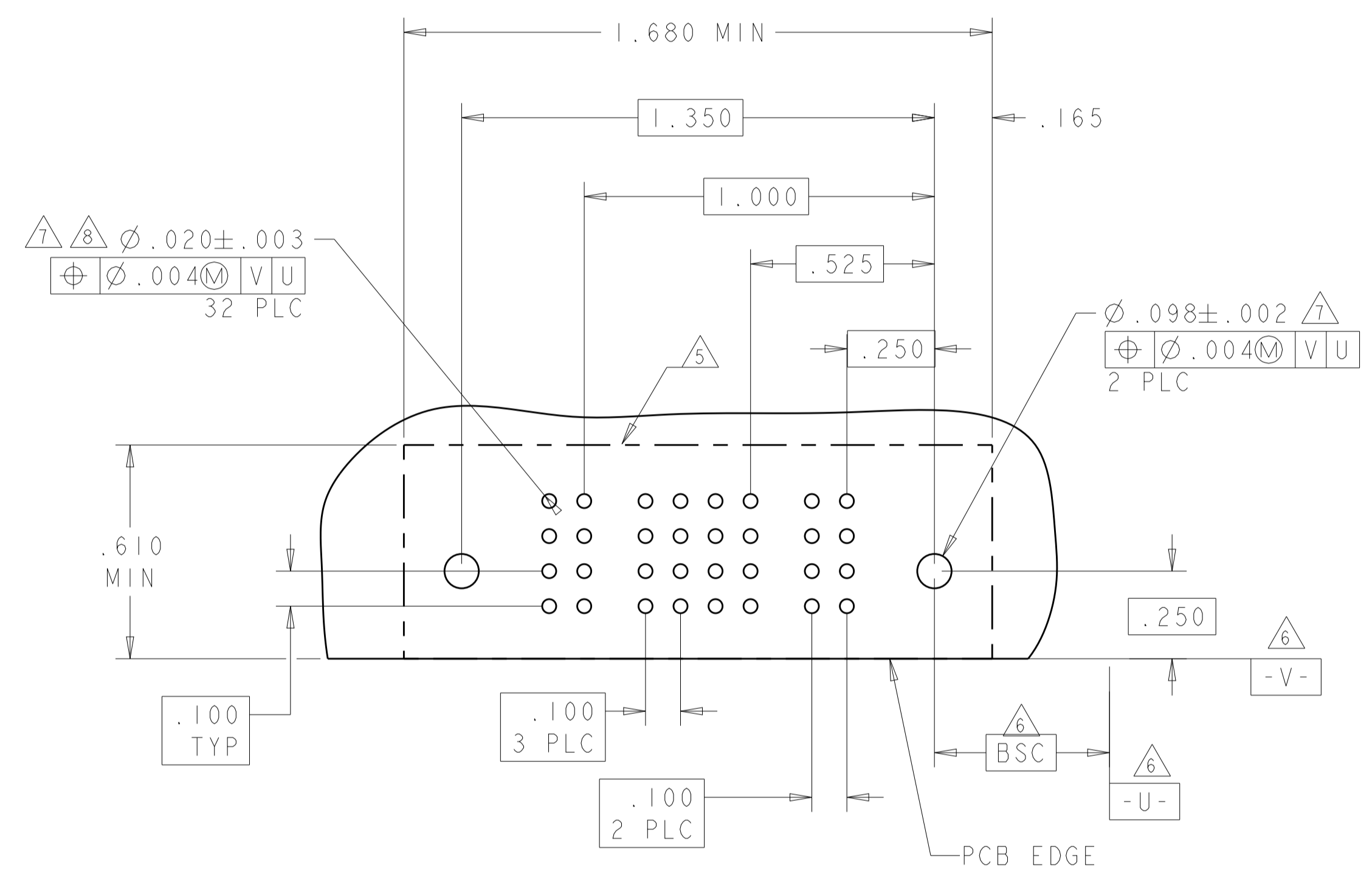

THIS DRAWING IS A CONTROLLED DOCUMENT.		OWN: R. GRZYBOWSKI / Z1FEB05	 TE Connectivity
DIMENSIONS: INCHES		CHK: M. PERCHERKE / Z1FEB05	
TOLERANCES UNLESS OTHERWISE SPECIFIED:		APVD: M. PERCHERKE	NAME: RIGHT ANGLE RECEPTACLE ASSEMBLY WITH GUIDES MULTI-BEAM XL
0 PLC ±.01 1 PLC ±.01 2 PLC ±.01 3 PLC ±.005 4 PLC ±.0020 ANGLES ±.2°		PRODUCT SPEC: 108-1973	RESTRICTED TO: -
MATERIAL: -		APPLICATION SPEC: 114-13038	SIZE: A100779
FINISH: -		WEIGHT: -	CAGE CODE: C=6450170
		CUSTOMER DRAWING	SCALE: 4:1 SHEET 7 OF 13 REV: J5

LOC	DIST	REVISIONS			
P	LTN	DESCRIPTION	DATE	DMN	APVD
ES	00	SEE SHEET 1	-	-	-

PART NUMBER	ROWS	POWER		SIGNAL				POWER		
		P4	P3	4	3	2	1	P2	P1	
3-6450170-1	D	RM	RA	H	H	H	H	RA	RM	HD
	C			G	G	G	G			
	B			E	E	E	E			
	A			F	F	F	F			
2P + 16S + 2P										

PART NUMBER	ROWS	POWER			SIGNAL						POWER				
		P7	P6	P5	6	5	4	3	2	1	P4	P3	P2	P1	
1-6450170-8	D	RM	RM	RA	H	H	H	H	H	H	RM	RM	RM	RM	HD
	C				G	G	G	G	G						
	B				F	F	F	F	F						
	A				E	E	E	E	E						
4P + 24S + 3ACP															

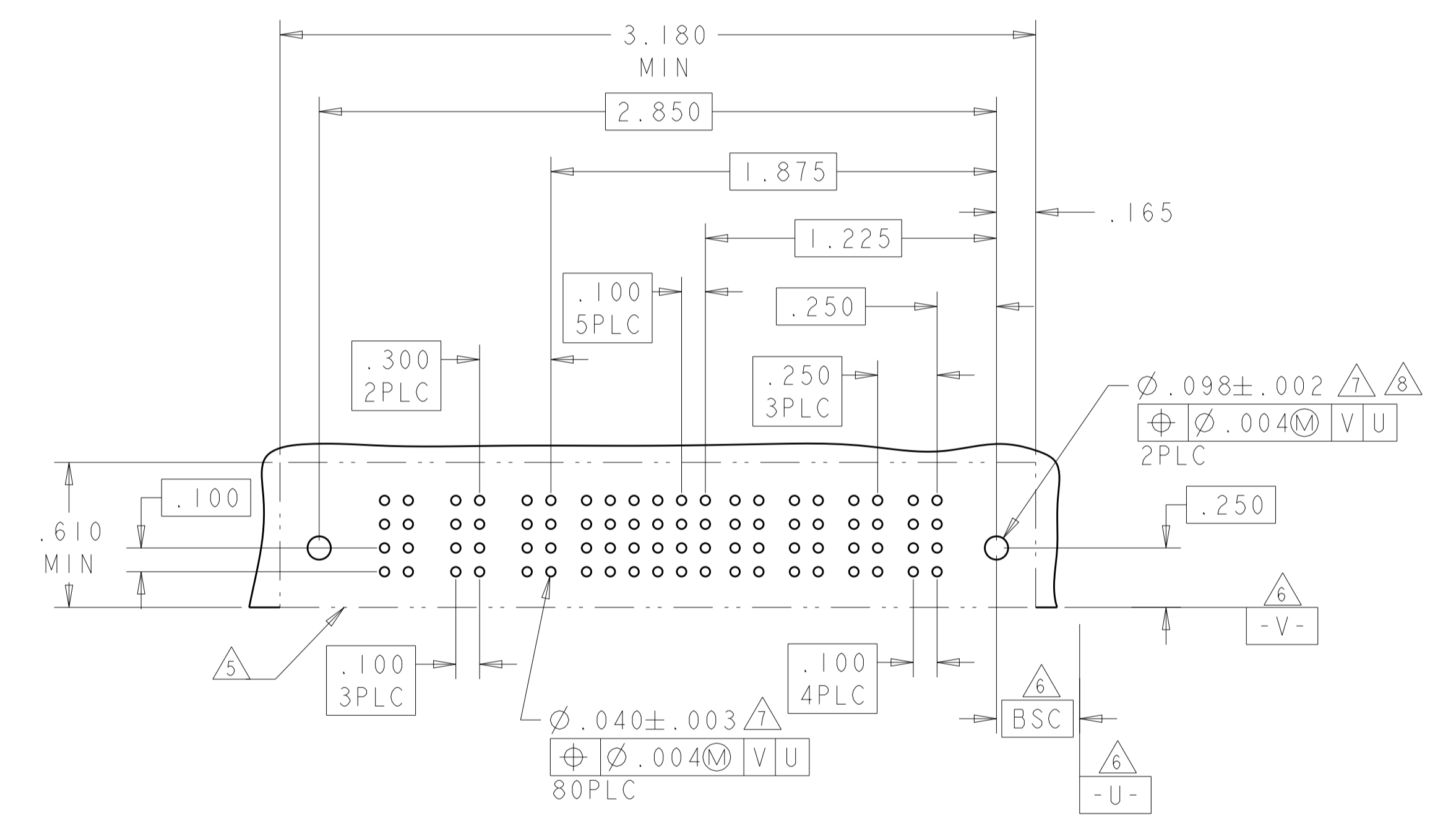
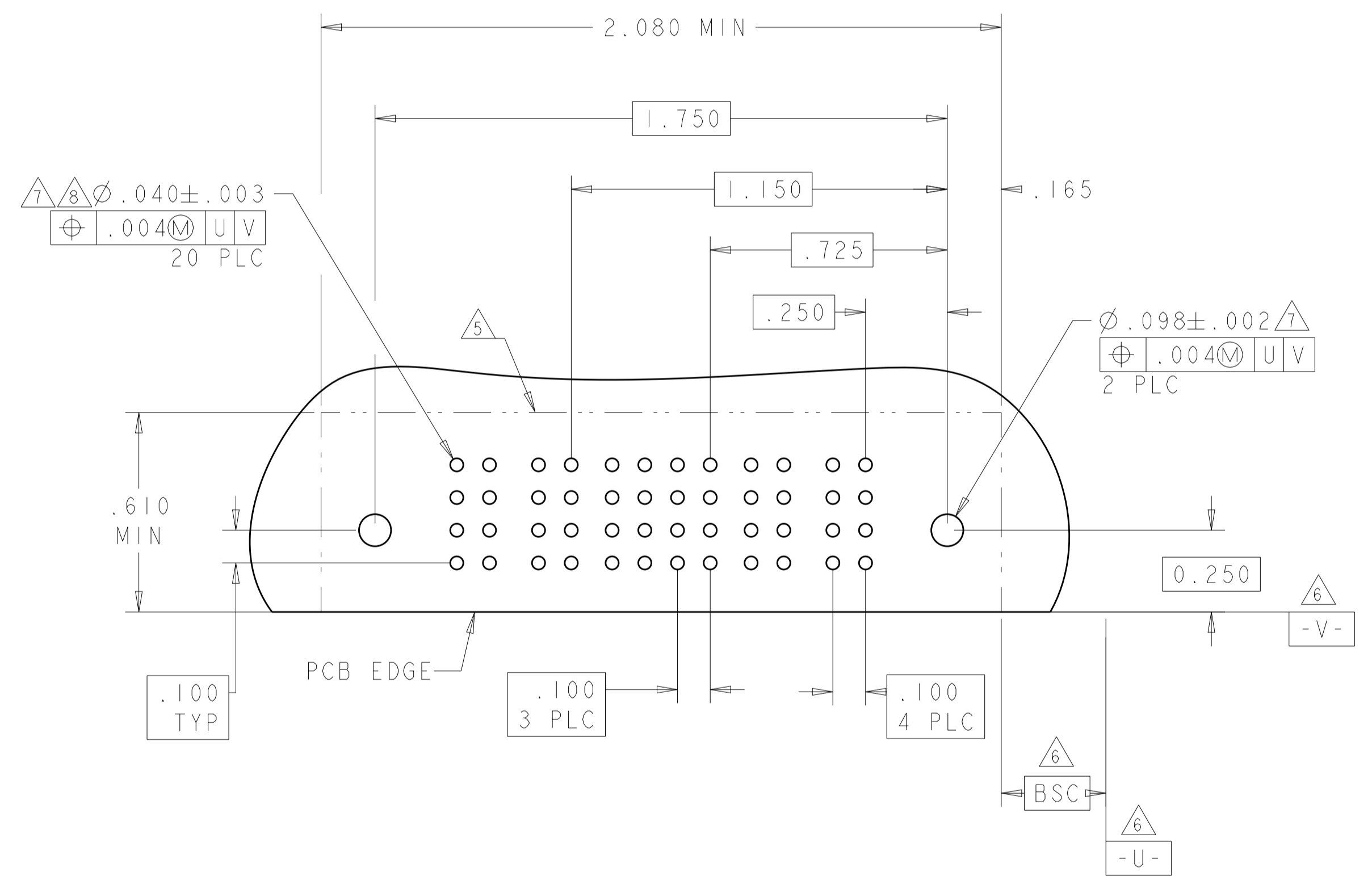

THIS DRAWING IS A CONTROLLED DOCUMENT. **STE** TE Connectivity

DIMENSIONS: INCHES	TOLERANCES UNLESS OTHERWISE SPECIFIED: 0 PLC ±.01 1 PLC ±.01 2 PLC ±.01 3 PLC ±.005 4 PLC ±.0020 ANGLES ±.020	DMN R.GRZYBOWSKI 21FEB05	NAME RIGHT ANGLE RECEPTACLE ASSEMBLY WITH GUIDES MULTI-BEAM XL
		CHK M.PERCHEKKE 21FEB05	
MATERIAL		APVD M.PERCHEKKE	SIZE CAGE CODE DRAWING NO
FINISH		PRODUCT SPEC 108-1973	A100779C=6450170
MATERIAL		APPLICATION SPEC 114-13038	SCALE 4:1 SHEET 8 OF 13 REV J5
MATERIAL		WEIGHT	CUSTOMER DRAWING

LOC	DIST	REVISIONS			
P	LTH	DESCRIPTION	DATE	DMN	APVD
ES	00	- SEE SHEET 1	-	-	-

PART NUMBER	ROWS	POWER	SIGNAL			POWER				
			P6	P5	3	2	1	P4	P3	P2
3-6450170-3	D C B A	RM RM	H	H	H	RM RM RM RM				
			G	G	G					
			F	F	F					
			E	E	E					
4ACP + 12S + 2P										

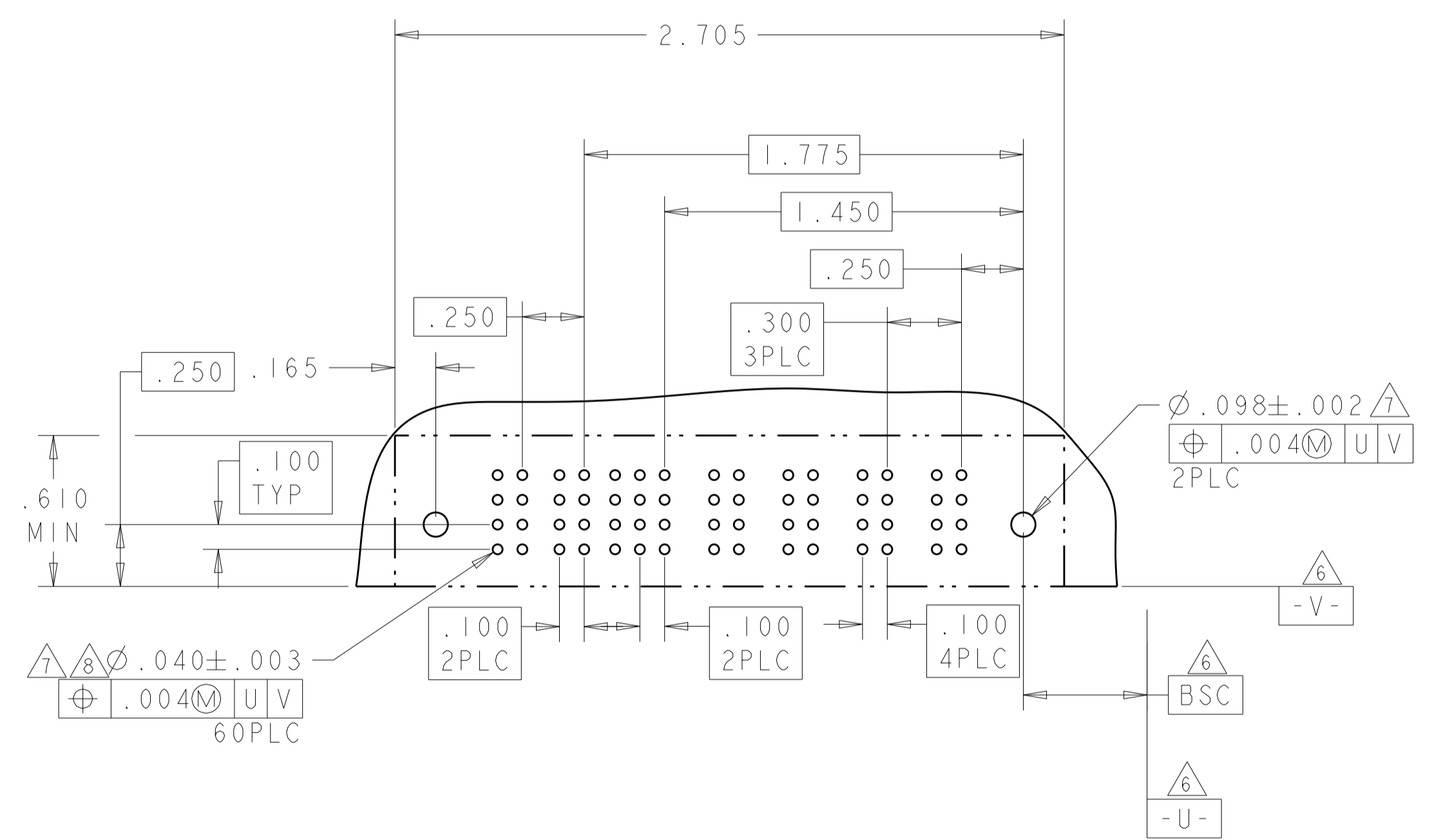

THIS DRAWING IS A CONTROLLED DOCUMENT. DWN: R.GRZYBOWSKI 21FEB05
 CHK: M.PERCHEKKE 21FEB05

TE Connectivity

RIGHT ANGLE RECEPTACLE ASSEMBLY WITH GUIDES MULTI-BEAM XL

NAME: R.GRZYBOWSKI 21FEB05
 PRODUCT SPEC: 108-1973
 APPLICATION SPEC: 114-13038
 SIZE: A100779 C=6450170
 WEIGHT: -
 MATERIAL: -
 FINISH: -

SCALE: 4:1 SHEET 9 OF 13 REV J5

LOC	DIST	REV	DATE	BY	APPV
ES	00				

REVISIONS					
NO	DATE	DESCRIPTION	BY	APPV	REV
-	-	SEE SHEET 1	-	-	-

PART NUMBER	ROWS	POWER					SIGNAL			POWER	
		P7	P6	P5	P4	P3	3	2	1	P2	P1
3-6450170-4	D C B A	RM	RM	RM	RM	RM	H	H	H	RM	RM
							G	G	G		
							F	F	F		
							E	E	E		
2P + 12S + 5P											

PART NUMBER	ROWS	POWER		SIGNAL		POWER	
		P4	P3	2	1	P2	P1
3-6450170-5	D C B A	RA	RA	H	H	RM	RM
				G	G		
				F	F		
				E	E		
2P + 8S + 2P							

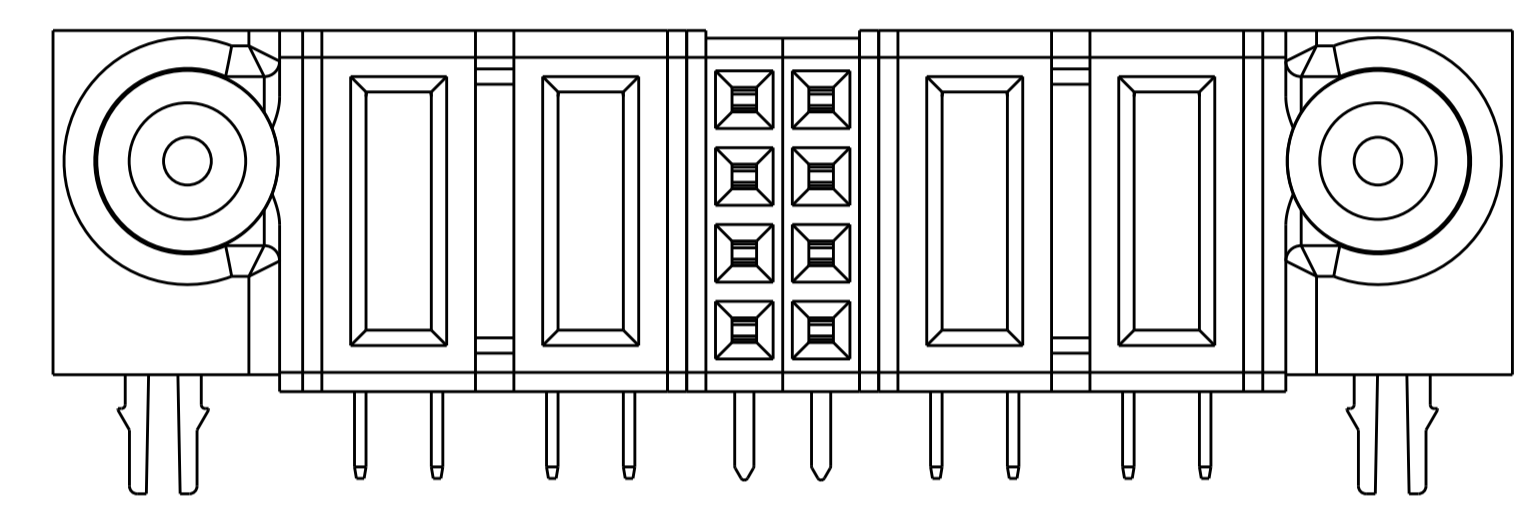
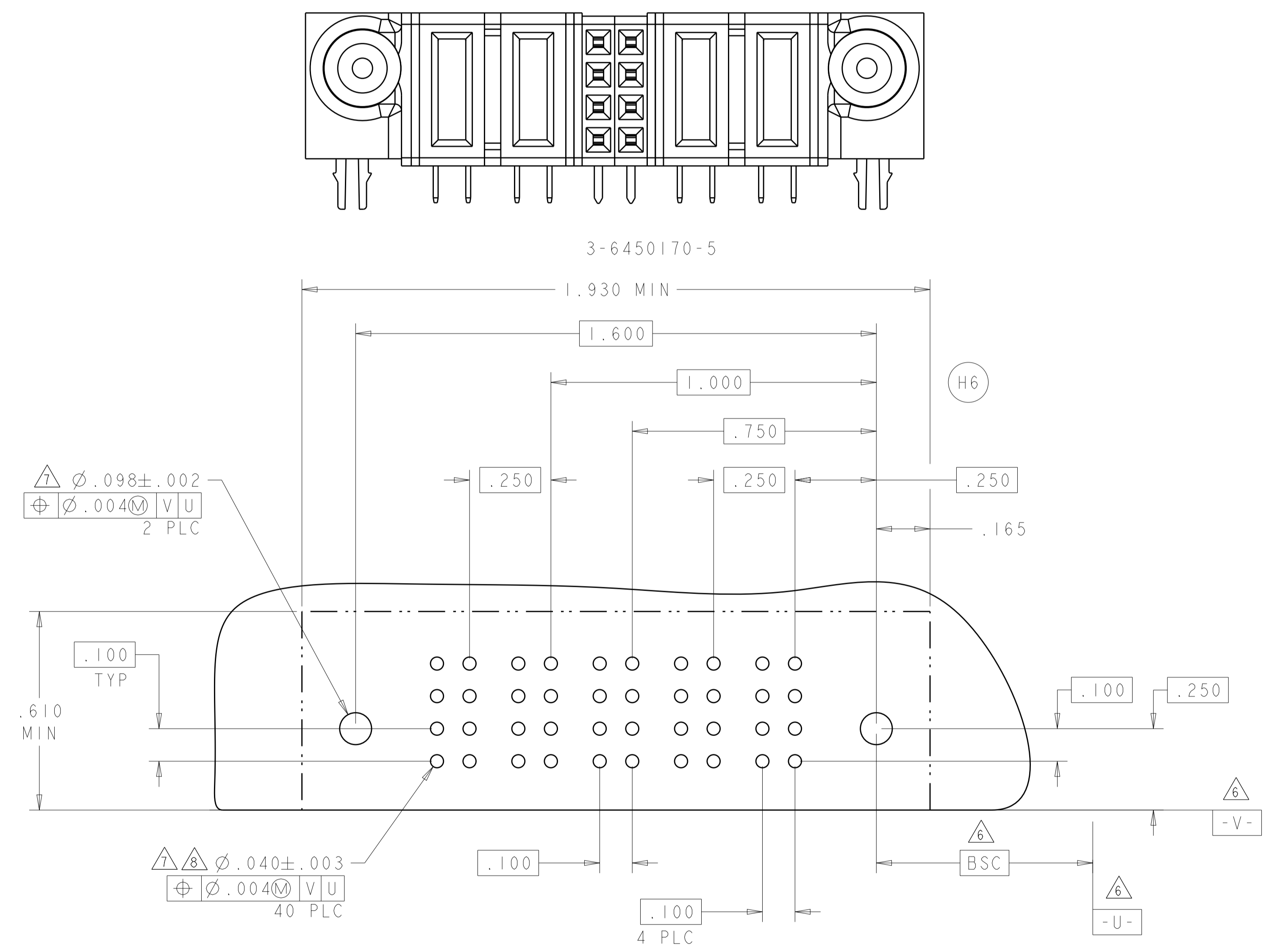
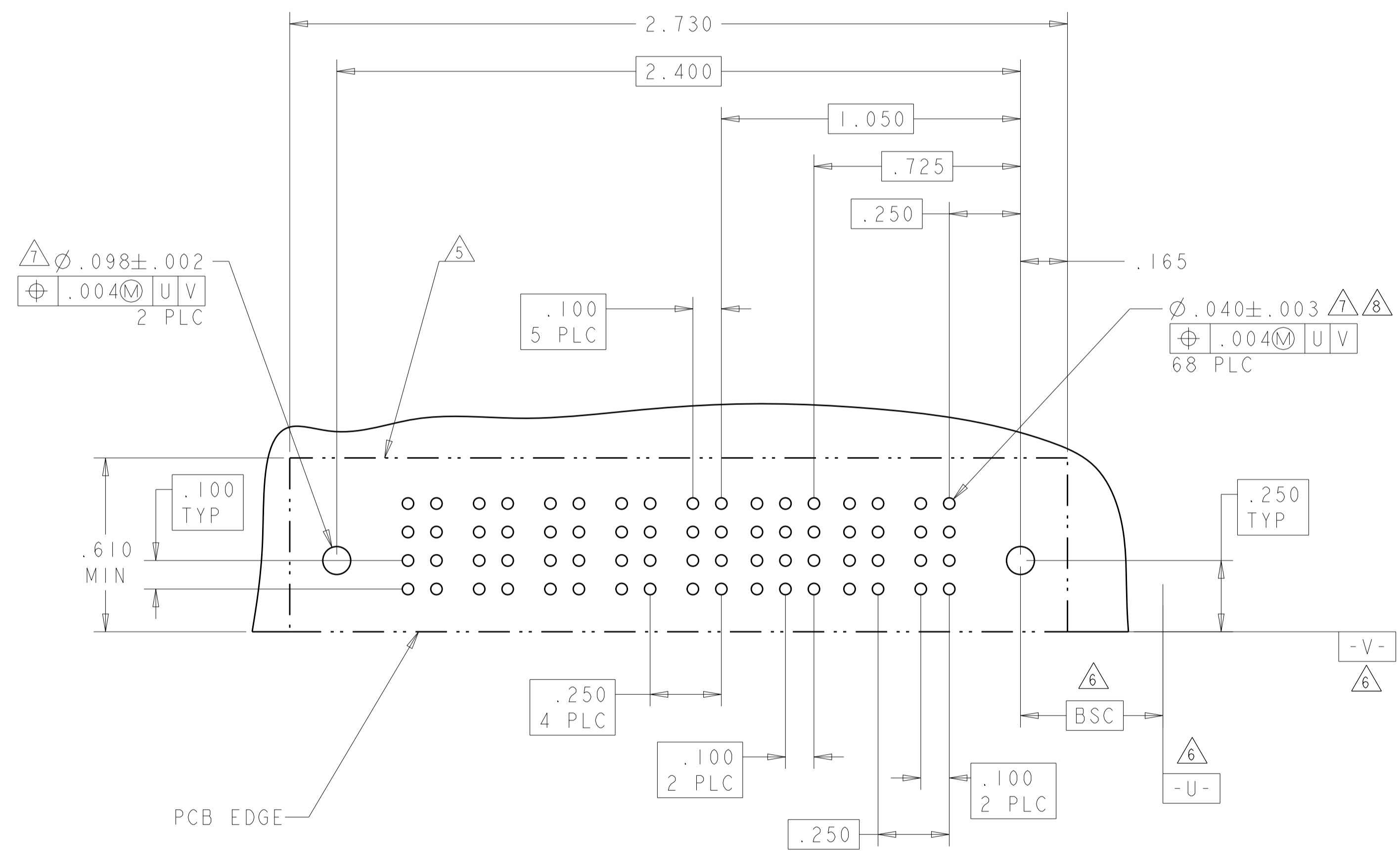

THIS DRAWING IS A CONTROLLED DOCUMENT.

DIMENSIONS:	TOLERANCES UNLESS OTHERWISE SPECIFIED:	OWN: R. GRZYBOWSKI	21FEB05
INCHES	0 PLC ±	CHK: M. PERCHERKE	21FEB05
	1 PLC ±.01	APVD: M. PERCHERKE	
	2 PLC ±.01	NAME:	RIGHT ANGLE RECEPTACLE ASSEMBLY WITH GUIDES MULTI-BEAM XL
	3 PLC ±.005	PRODUCT SPEC:	108-1973
	4 PLC ±.0020	APPLICATION SPEC:	114-13038
	ANGLES ±.0020	SIZE:	A100779
MATERIAL:	FINISH:	WEIGHT:	CAGE CODE: 6450170
			SCALE: 4:1
			SHEET 10 OF 13
			REV J5

4805 (3/11)

LOC	DIST	REV	DATE	BY	APPV
ES	00				

REVISIONS		DATE	BY	APPV
-	SEE SHEET 1	-	-	-

PART NUMBER	ROWS	POWER		SIGNAL				POWER		H7
		P4	P3	4	3	2	1	P2	P1	
3-6450170-6	D	RA	RA	H	H	H	H	RM	RM	H7
	C			G	G	G	G			
	B			E	E	E	E			
	A			F	F	F	F			

2P + 16S + 2P

PART NUMBER	ROWS	POWER		SIGNAL								POWER		H8	
		P2	P1	8	7	6	5	4	3	2	1	P2	P1		
3-6450170-7	D	RA	RA	H	H	H	H	H	H	H	H	H	RM	RM	H8
	C			G	G	G	G	G	G	G					
	B			F	F	F	F	F	F	F					
	A			E	E	E	E	E	E	E					

IP + 32S + IP

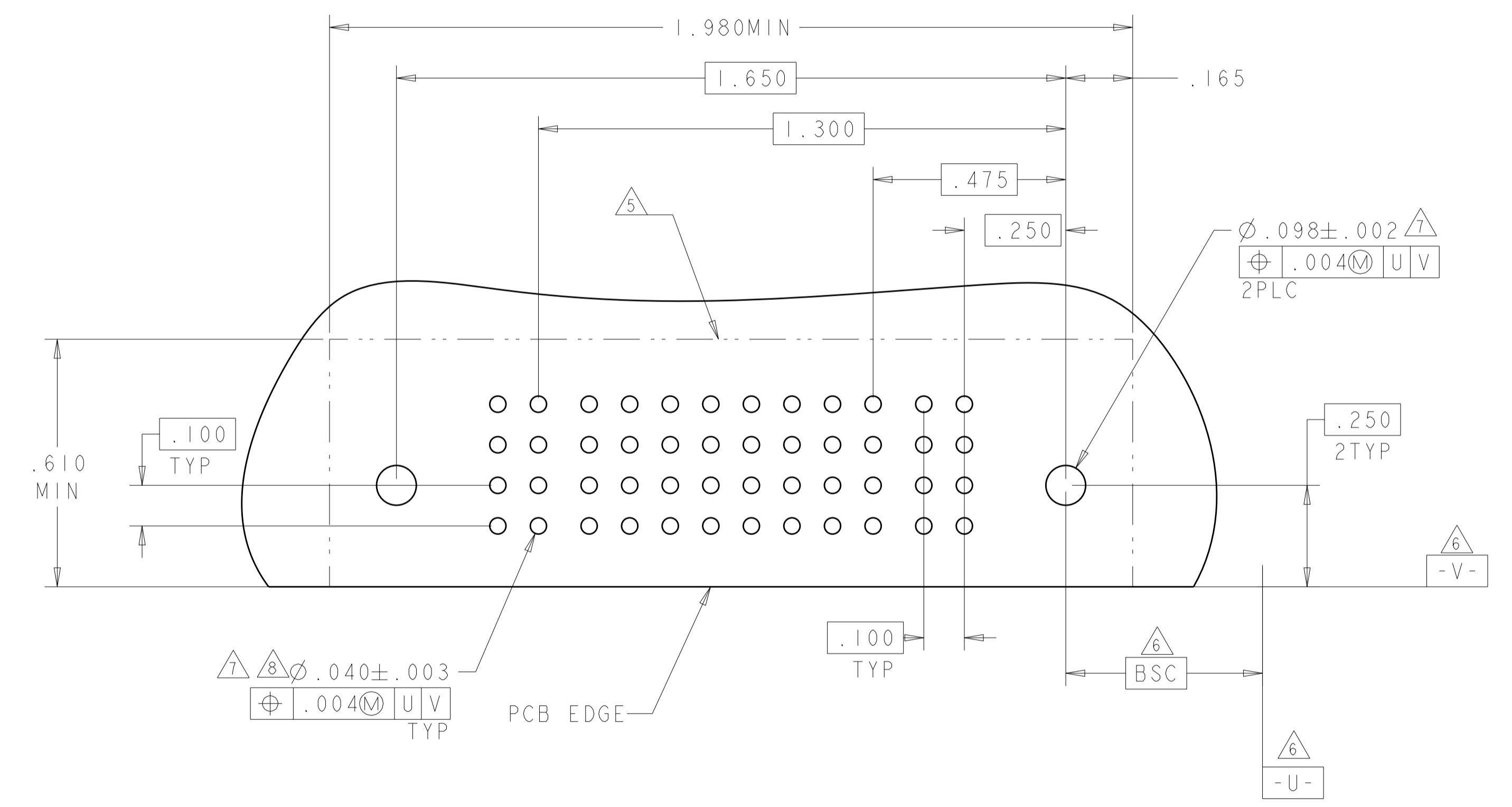
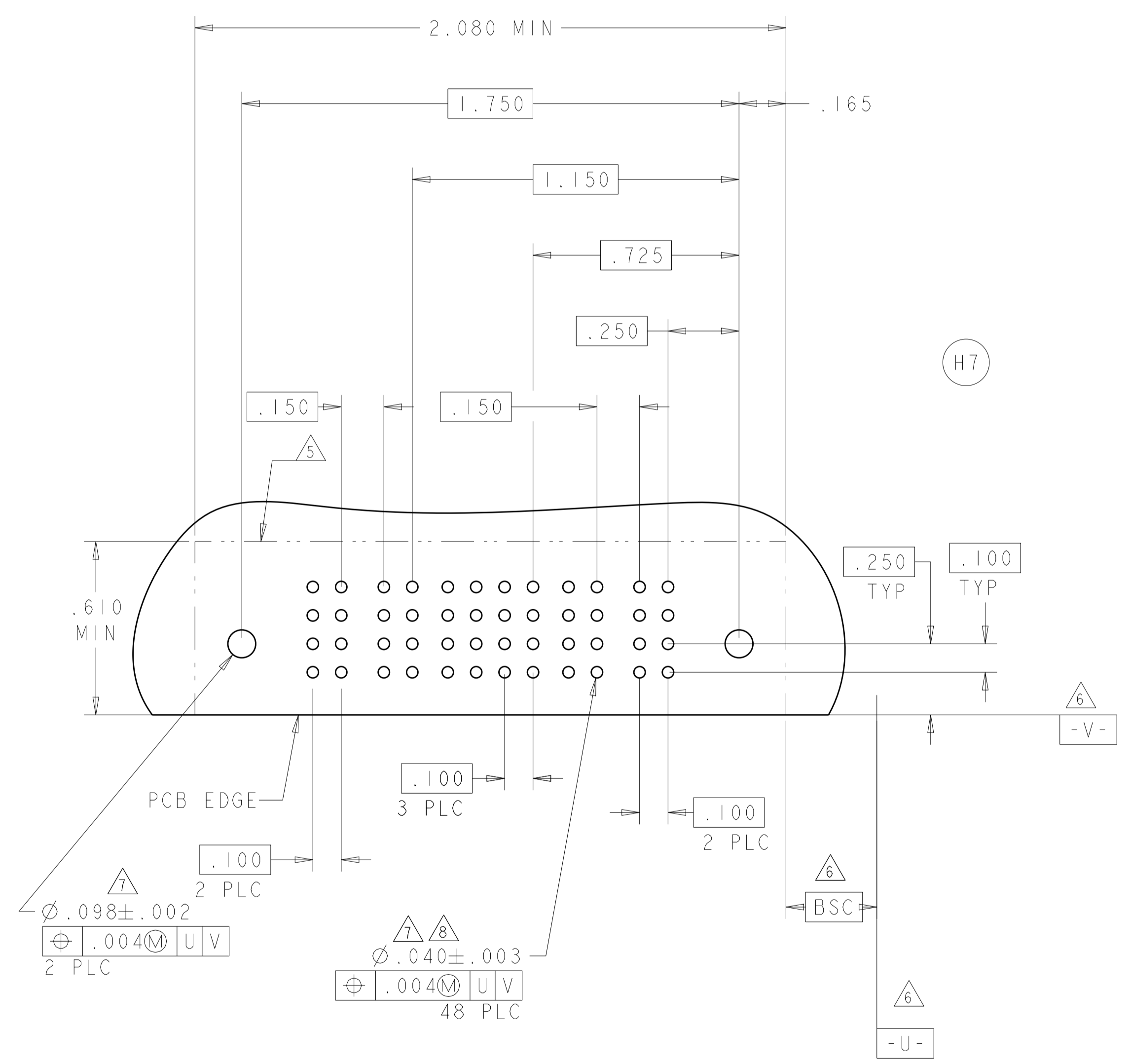

THIS DRAWING IS A CONTROLLED DOCUMENT.

DIMENSIONS:	TOLERANCES UNLESS OTHERWISE SPECIFIED:	OWN	R. GRZYBOWSKI	21FEB05
INCHES	0 PLC ± .01	CHK	M. PERCHERKE	21FEB05
	1 PLC ± .01	APVD	M. PERCHERKE	
	2 PLC ± .01	NAME	RIGHT ANGLE RECEPTACLE ASSEMBLY WITH GUIDES MULTI-BEAM XL	
	3 PLC ± .005	PRODUCT SPEC	108-1973	
	4 PLC ± .002	APPLICATION SPEC	114-13038	
	ANGLES ± .020	SIZE	CAGE CODE	DRAWING NO
MATERIAL	FINISH	WEIGHT	A100779	C=6450170
		CUSTOMER DRAWING	SCALE	4:1

RESTRICTED TO SHEET 11 OF 13 REV J5

LOC		DIST		REVISONS			
ES	00	P	LTH	DESCRIPTION	DATE	DWN	APVD
		-		SEE SHEET 1	-	-	-

PART NUMBER	ROWS	POWER		SIGNAL								POWER						
		P2	P1	10	9	8	7	6	5	4	3	2	1	P1	P2			
3-6450170-8	D C B A	RM	RM	H	H	H	H	H	H	H	H	H	H	H	H	H		
				G	G	G	G	G	G	G	G	G	G	G	G	G	G	
				F	F	F	F	F	F	F	F	F	F	F	F	F	F	F
				E	E	E	E	E	E	E	E	E	E	E	E	E	E	E
IP + 40S + IP		HD												HD				

PART NUMBER	ROWS	POWER		SIGNAL		POWER		
		P5	P4	2	1	P3	P2	P1
3-6450170-9	D C B A	RM	RM	H	H	RA	RM	RM
				G	G			
				F	F			
				E	E			
3ACP + 8S + 2P		HD				HD		

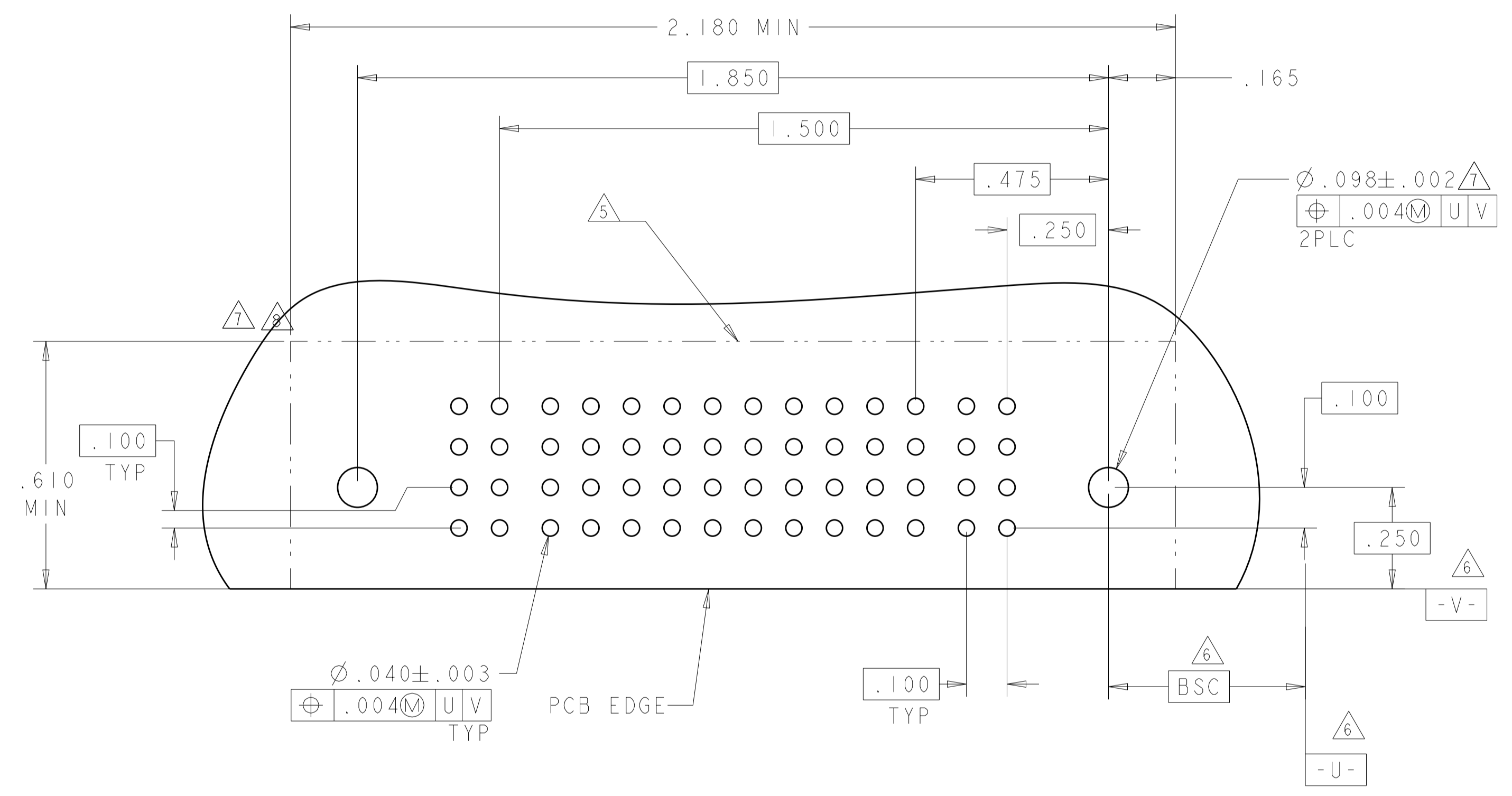

TE RECOMMENDED PCB LAYOUT

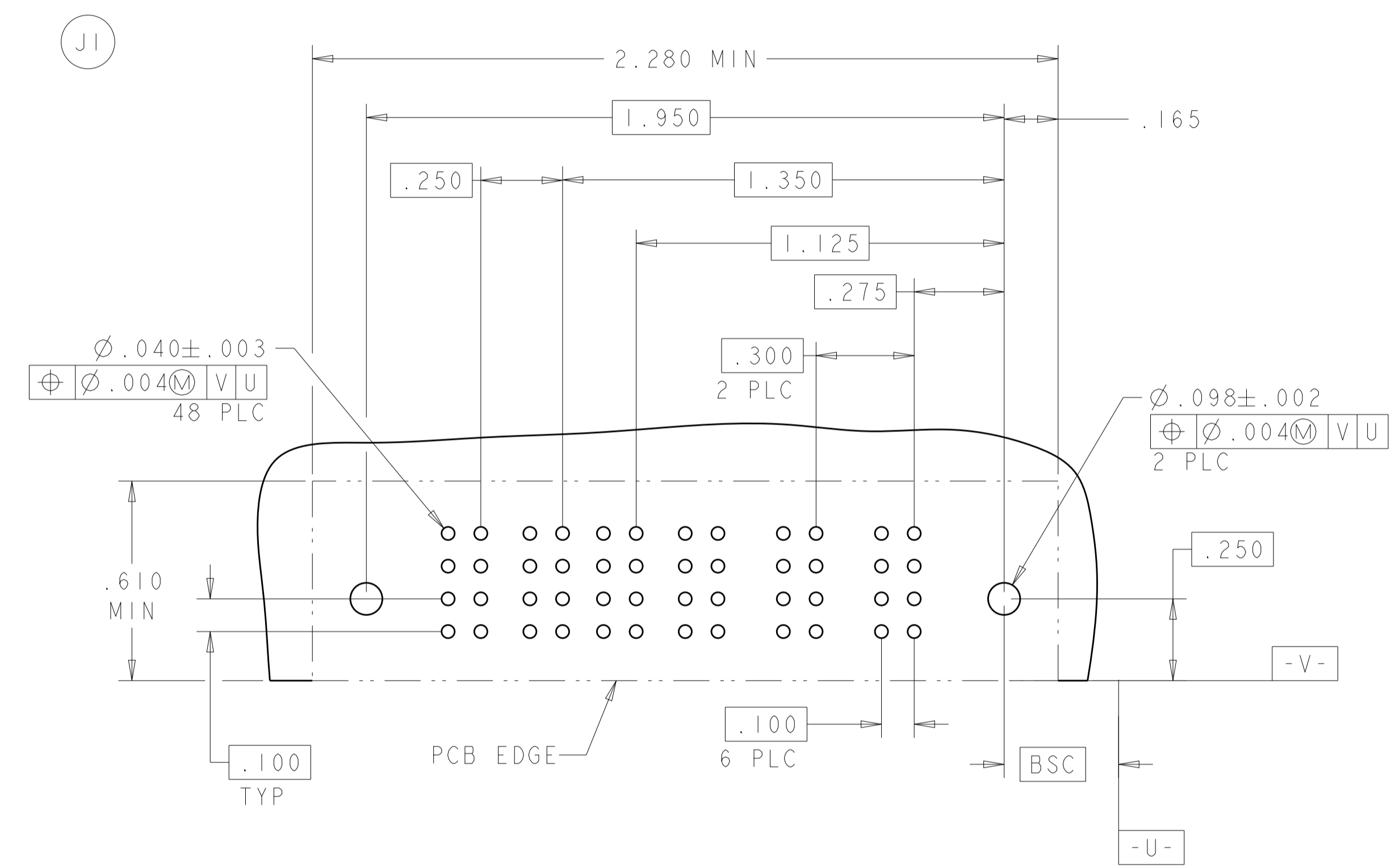

THIS DRAWING IS A CONTROLLED DOCUMENT.		DWN: R. GRZYBOWSKI 21FEB05	 TE Connectivity
DIMENSIONS: INCHES		CHK: M. PERCHERKE 21FEB05	
TOLERANCES UNLESS OTHERWISE SPECIFIED: 0 PLC ±. 1 PLC ±.01 2 PLC ±.01 3 PLC ±.005 4 PLC ±.0020 ANGLES ±.020		APVD: M. PERCHERKE	NAME: RIGHT ANGLE RECEPTACLE ASSEMBLY WITH GUIDES MULTI-BEAM XL
MATERIAL: -		FINISH: -	PRODUCT SPEC: 108-1973
		APPLICATION SPEC: 114-13038	RESTRICTED TO: -
		WEIGHT: -	SIZE: A100779 C=6450170
		CUSTOMER DRAWING	SCALE: 4:1 SHEET 12 OF 13 REV J5

LOC	DIST	REVISIONS					
		P	LTH	DESCRIPTION	DATE	OWN	APVD
ES	00	-	-	SEE SHEET 1	-	-	-

PART NUMBER	ROWS	POWER				SIGNAL			POWER					
		P10	P9	P8	P7	3	2	1	P6	P5	P4	P3	P2	P1
4-6450170-0	D	RM	RM	RM	RM	H	H	H	RM	RM	RM	RM	RA	RA
	C					G	G	G						
	B					F	F	F						
	A					E	E	E						

6P + 12S + 4P

PART NUMBER	ROWS	POWER				SIGNAL						POWER								
		P8	P7	P6	P5	P4	P3	6	5	4	3	2	1	P2	P1					
4-6450170-1	D	RM	RM	RM	RA	RA	RA	RA	RA	RA	RA	RA	RA	RA						
	C														G	G	G	G	G	
	B														F	F	F	F	F	F
	A														E	E	E	E	E	E

2P + 24S + 6P

NO CONTACTS LOADED

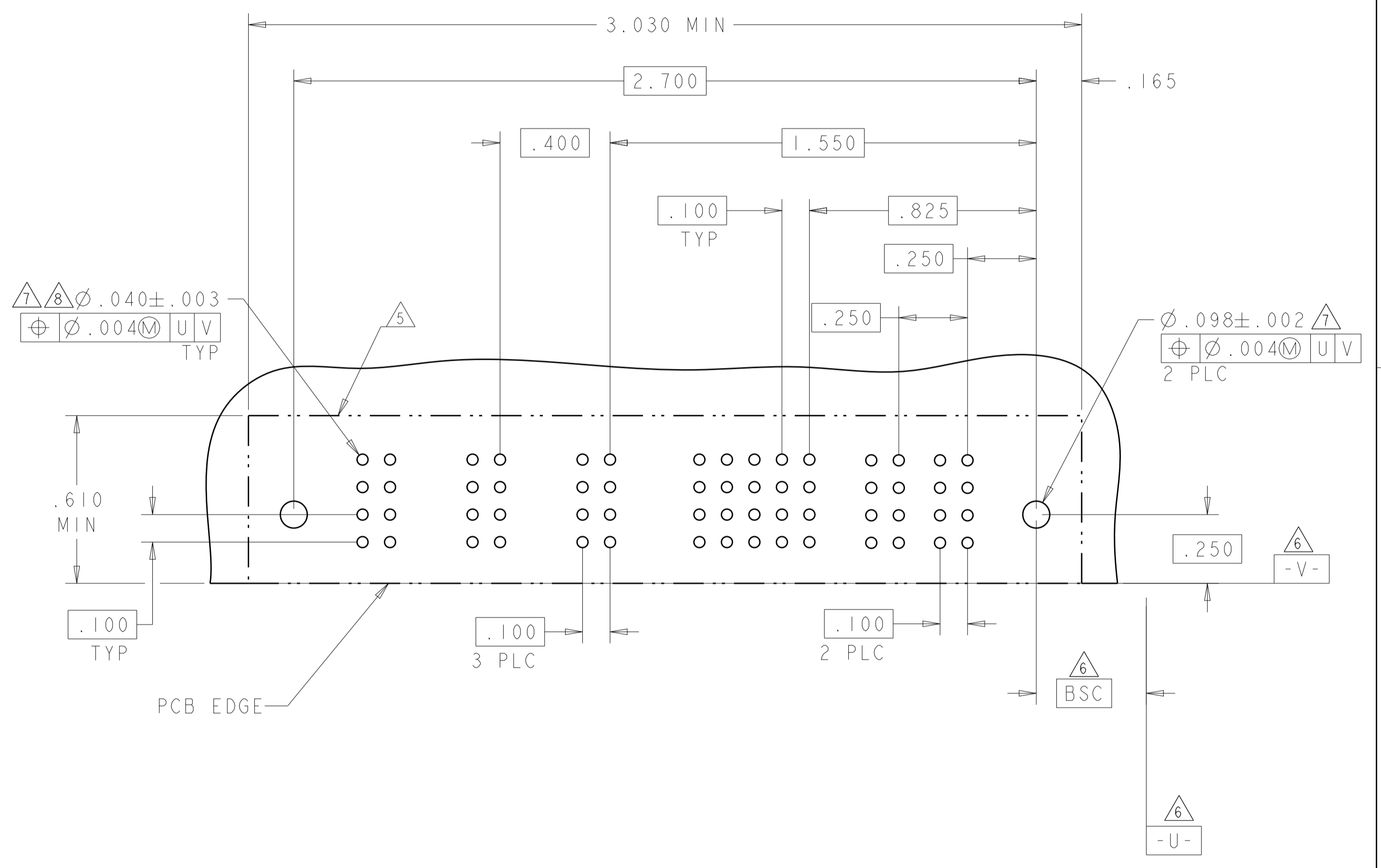
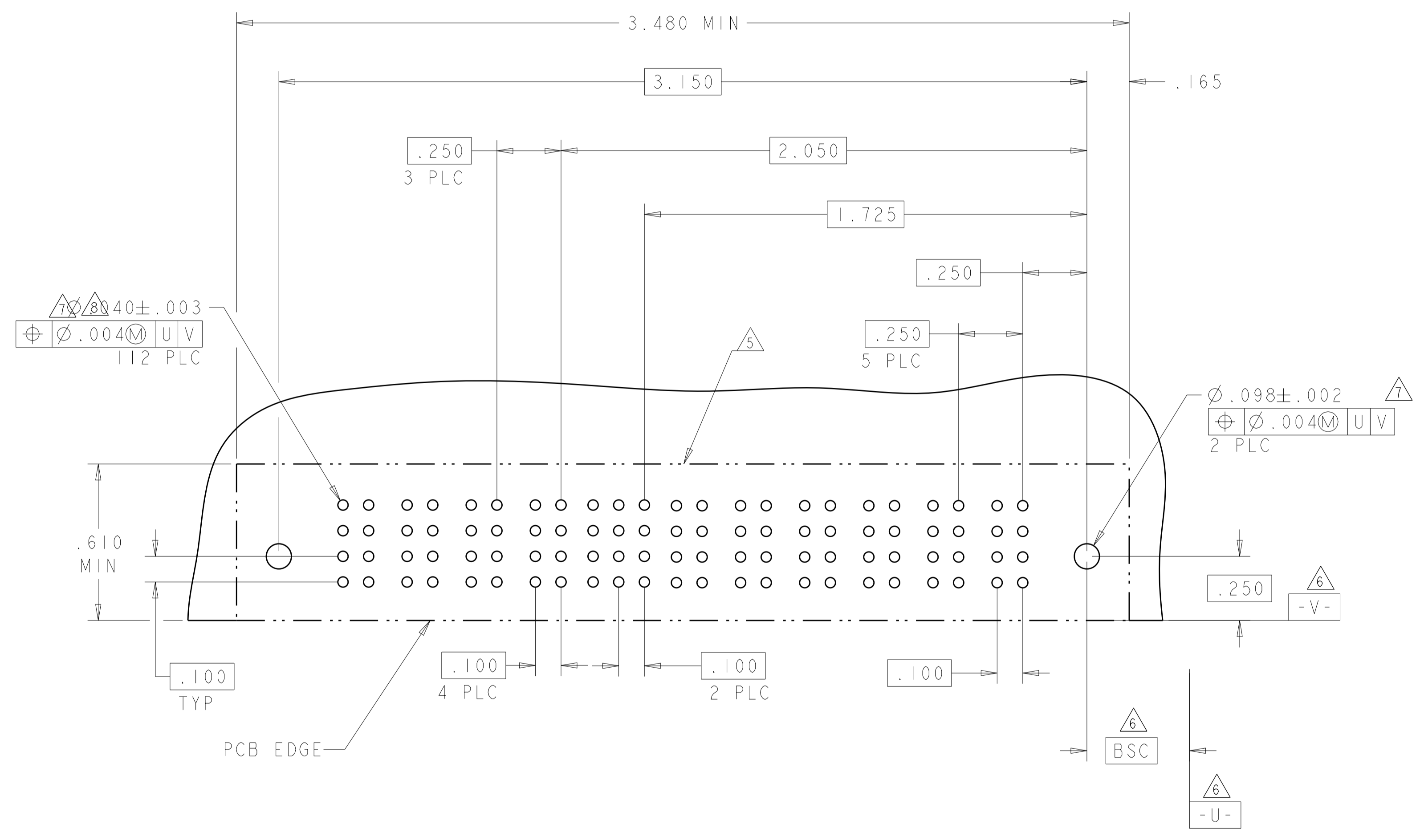

DIMENSIONS:		TOLERANCES UNLESS OTHERWISE SPECIFIED:	
INCHES		0 PLC	± .01
		1 PLC	± .01
		2 PLC	± .01
		3 PLC	± .01
		4 PLC	± .005
		ANGLES	± .0020
		FINISH	AS MANUFACTURED

THIS DRAWING IS A CONTROLLED DOCUMENT.		DWN: R.GRZYBOWSKI 21FEB05	
		CHK: M.PERCHEKKE 21FEB05	
		APVD: M.PERCHEKKE	
MATERIAL: -		NAME: -	
		PRODUCT SPEC: -	
		APPLICATION SPEC: 108-1973	
		SIZE: 114-13038	
		WEIGHT: -	
CUSTOMER DRAWING		SCALE: 4:1 SHEET 13 OF 13 REV J5	

Mouser Electronics

Authorized Distributor

Click to View Pricing, Inventory, Delivery & Lifecycle Information:

[TE Connectivity:](#)

[6450170-8](#)