

LOC	DIST	REVISIONS					
AR	39	P	LTR	DESCRIPTION	DATE	DWN	APVD
		D3		REVISED PER ECO-12-003620	16FEB2011	RW	SY

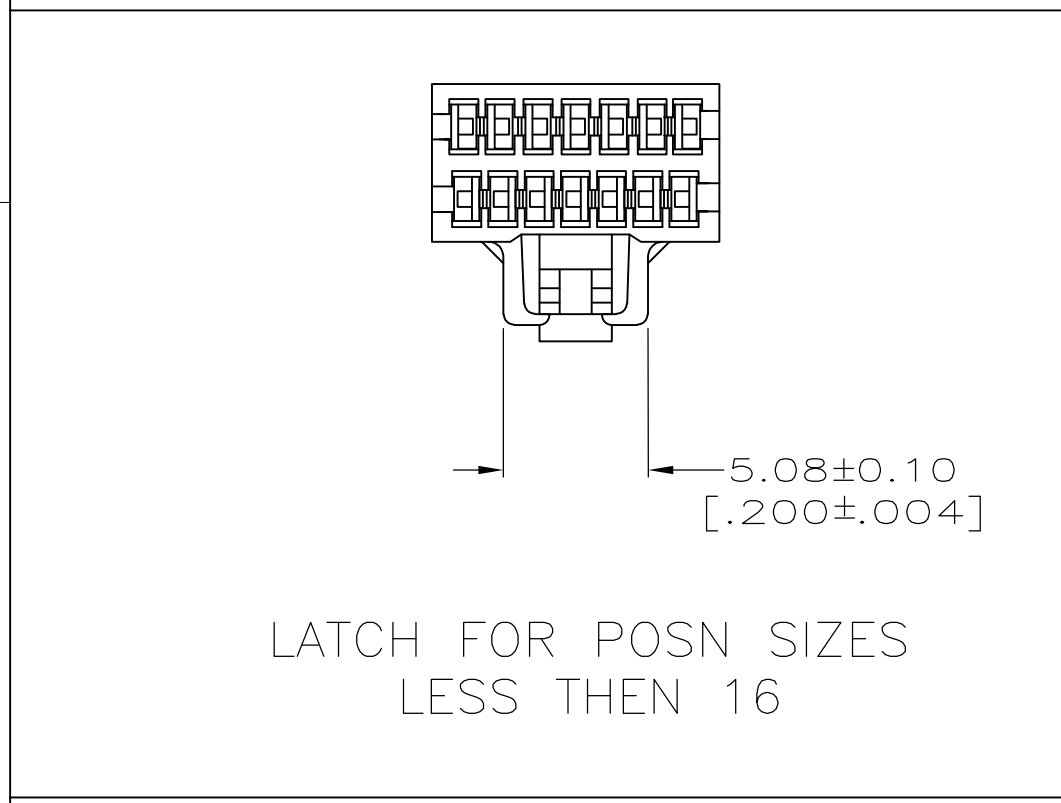
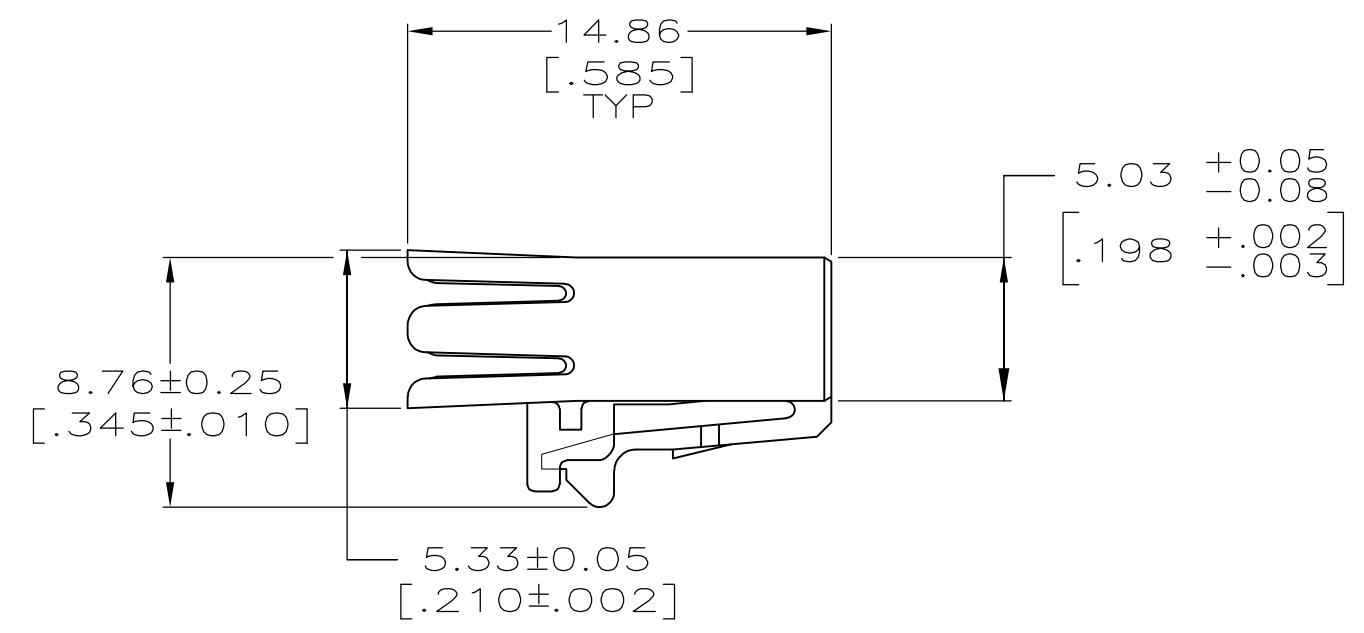
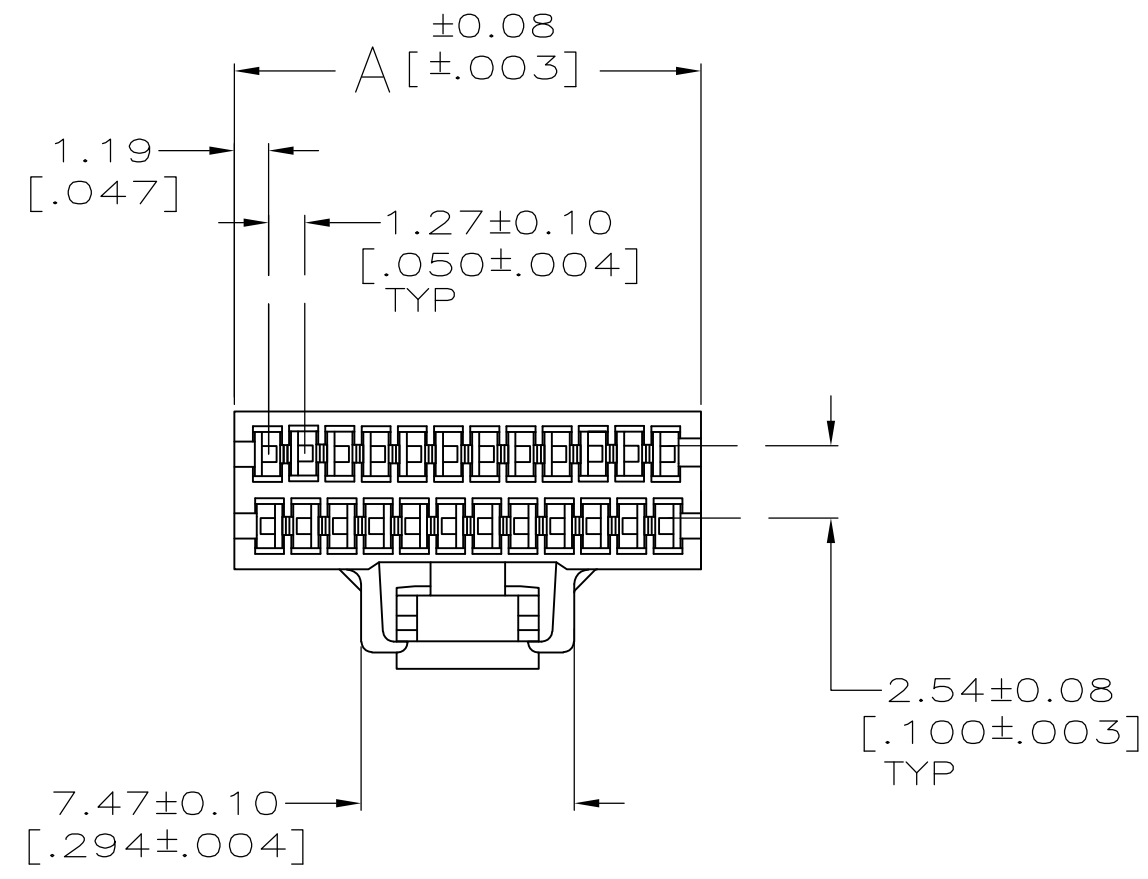

1 OBSOLETE PARTS: OBSOLETE CIS STREAMLINING PER D.RENAUD/D.SINISI

	51.99 [2.047]	80	8-487937-0
	46.91 [1.847]	72	7-487937-2
	39.29 [1.547]	60	6-487937-0
	32.94 [1.297]	50	5-487937-0
1 OBSOLETE	29.13 [1.147]	44	4-487937-4
	26.59 [1.047]	40	4-487937-0
	22.78 [.897]	34	3-487937-4
	20.24 [.797]	30	3-487937-0
	17.70 [.697]	26	2-487937-6
	16.43 [.647]	24	2-487937-4
	13.89 [.547]	20	2-487937-0
	11.35 [.447]	16	1-487937-6
	10.08 [.397]	14	1-487937-4
	8.81 [.347]	12	1-487937-2
	7.54 [.297]	10	1-487937-0
1 OBSOLETE	6.27 [.247]	8	487937-8
	64.69 [2.547]	100	487937-1
	A	NO OF POSN	PART NO

THIS DRAWING IS A CONTROLLED DOCUMENT.		DWN C.OBERMAN 02/08/91	STE TE Connectivity	
DIMENSIONS: mm[INCHES]		CHK J McCLINTON 3-5-91		
TOLERANCES UNLESS OTHERWISE SPECIFIED:		APVD D L.ROCKER 3-6-91	NAME HOUSING, RCPT, .050 , FFC	
0 PLC ± -		PRODUCT SPEC	SIZE	
1 PLC ± -		APPLICATION SPEC	CAGE CODE	
2 PLC ± 0.13 [.005]		WEIGHT	DRAWING NO	
3 PLC ± -		MATERIAL POLYESTER BLACK	RESTRICTED TO	
4 PLC ± -		FINISH	A2 00779 G-487937	
ANGLES ± ± -		CUSTOMER DRAWING	SCALE 4:1 SHEET 1 OF 1 REV D3	

Mouser Electronics

Authorized Distributor

Click to View Pricing, Inventory, Delivery & Lifecycle Information:

[TE Connectivity:](#)

[6-487937-0](#)