

Ultra-compact EMC/RFI Filter for Motor Drives Applications



- New: solid safety connector blocks available for the whole range
- Exceptional attenuation performance from 150 kHz to 30 MHz
- Excellent saturation resistance up to 50 m cable length
- Most compact and slim filter design in its class



Performance indicators

Attenuation performance



Rated current [A]

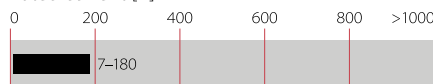

Technical specifications

Maximum continuous operating voltage	3x 480/277 VAC (FN 3258) 3x 520/300 VAC (FN 3258 H)
Operating frequency	DC to 60 Hz
Rated currents	7 to 180 A @ 50°C
High potential test voltage	P → E 2650 / 2750 VDC for 2 sec (FN 3258 / FN 3258H) P → P 2100 / 2250 VDC for 2 sec (FN 3258 / FN 3258H)
Protection category	IP 20
Overload capability	1.5x rated current for 1 minute, once per hour 4x rated current at switch on,
Temperature range (operation and storage)	-25°C to +100°C (25/100/21)
Flammability corresponding to	UL 94 V-2 or better
Design corresponding to	UL 1283, CSA 22.2 No. 8 1986, IEC/EN 60939
MTBF @ 50°C/400 V (Mil-HB-217F)	300,000 hours

Approvals



Features and benefits

- The extremely compact and slim filter design allows a trouble-free installation even where the available mounting space is minimal
- With new additional filter types providing safety terminal blocks, the most preferred connection style can be chosen fast and easy. This helps to stay in line with the electrical connection concept of a given application
- FN 3258 filters ensure compliance with Class A limits according to EN 55011 up to 50 m cable length and beyond. Further they can contribute significantly to meet conducted emission limits according to Class B
- Filter operation on the mains input side of consumers increases their reliability and conducted immunity significant
- Chokes with exceptional saturation resistance and excellent thermal behavior are a vital part of FN 3258 design. Thus, all filters retain the expected filter performance even in very noisy applications and under full load conditions

Typical applications

- Three-phase variable speed motor drives, servo drives, inverters and converters
- Applications comprising energy conversion devices like machines or process automation equipment
- HVAC equipment, elevators, power supplies, UPS and further three-phase applications

Typical electrical schematic

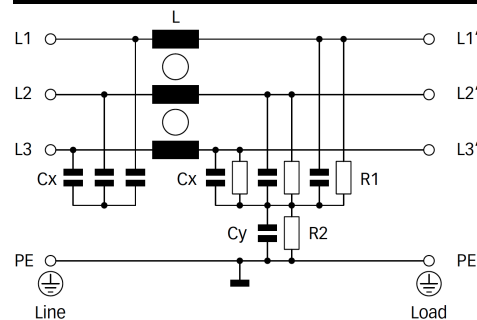

Filter selection table

Filter	Rated current @ 50°C (40°C) [A]	Typical drive power rating* [kW]	Leakage current** @ 480/520 VAC/50 Hz [mA]	Power loss @ 25°C/50 Hz [W]	Input/Output connections 	Weight [kg]
FN 3258-7-44	7 (7.7)	4	4.3	3.8	-44	0.5
FN 3258-16-44	16 (17.5)	7.5	4.3	6.1	-44	0.8
FN 3258-30-33	30 (32.9)	15	4.3	11.8	-33	1.2
FN 3258-42-33	42 (46.0)	22	4.3	15.7	-33	1.4
FN 3258-55-34	55 (60.2)	30	4.3	25.9	-34	2.0
FN 3258-75-34	75 (82.2)	37	4.3	32.2	-34	2.7
FN 3258-100-35	100 (109.5)	55	4.3	34.5	-35	4.3
FN 3258-130-35	130 (142.4)	75	4.3	43.1	-35	4.5
FN 3258-180-40	180 (197.1)	90	4.3	58.3	-40	6.0
FN 3258 H-7-44	7 (7.7)	4	4.7	3.8	-44	0.5
FN 3258 H-16-44	16 (17.5)	7.5	4.7	6.1	-44	0.8
FN 3258 H-30-33	30 (32.9)	18.5	4.7	11.8	-33	1.2
FN 3258 H-42-33	42 (46.0)	22	4.7	15.7	-33	1.4
FN 3258 H-55-34	55 (60.2)	37	4.7	25.9	-34	2.0
FN 3258 H-75-34	75 (82.2)	45	4.7	32.2	-34	2.7
FN 3258 H-100-35	100 (109.5)	55	4.7	34.5	-35	4.3
FN 3258 H-130-35	130 (142.4)	75	4.7	43.1	-35	4.5
FN 3258 H-180-40	180 (197.1)	110	4.7	58.3	-40	6.0

* Calculated at rated current, 440 VAC (FN 3258)/480 VAC (FN 3258 H) and $\cos \phi=0.8$. The exact value depends upon the efficiency of the drive, the motor and the entire application.

** Standardized calculated leakage current acc. IEC60939 under normal operating conditions (FN 3258 at 480 VAC and FN 3258H at 520 VAC).

Thermal Derating

If higher ambient temperatures than the specified apply, the nominal current needs to be reduced according to the graph below.

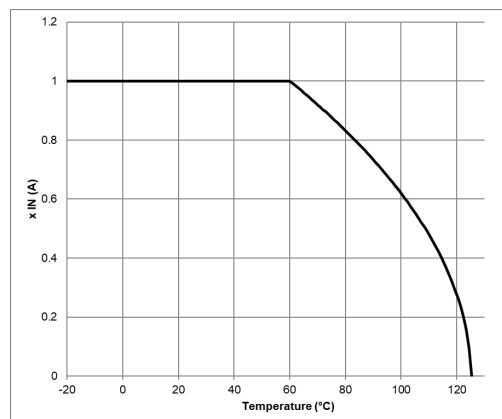

Typical filter attenuation

Per CISPR 17; DM=50/50 sym; CM=50/50 asym

7 A type

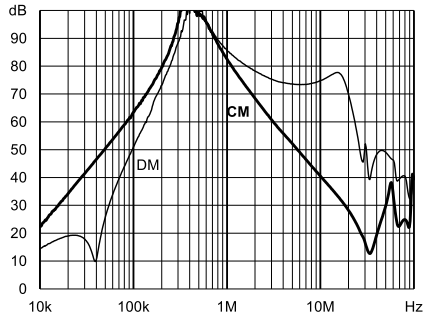

16 A type

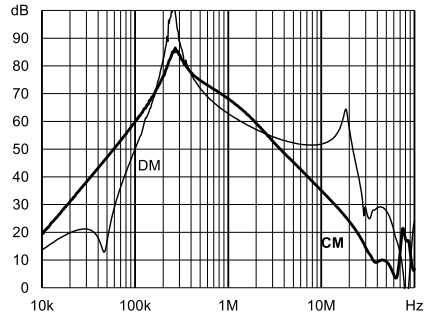

30 A type

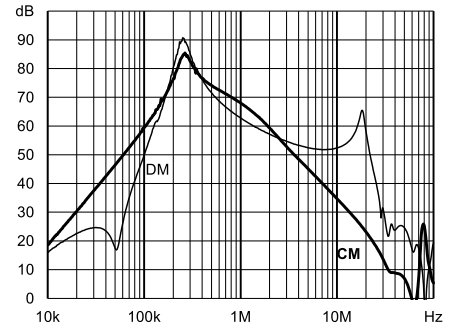

42 A type

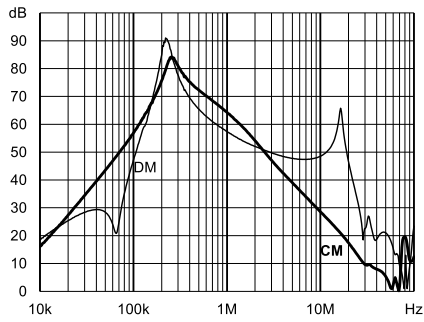

55 A type

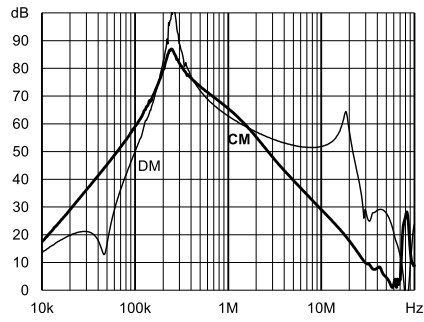

75 A type

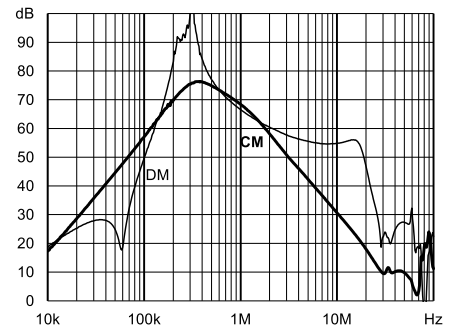

100 A type

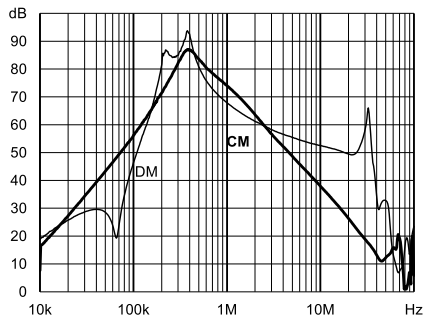

130 A type

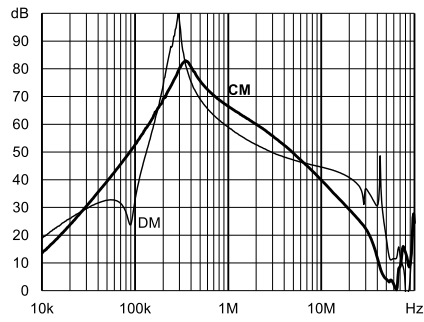

180 A type

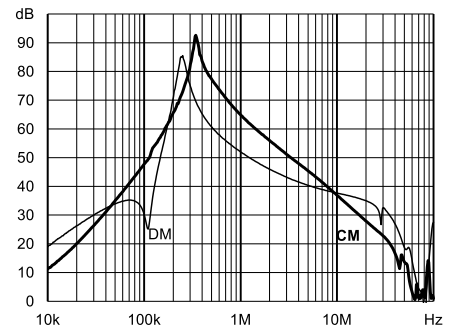

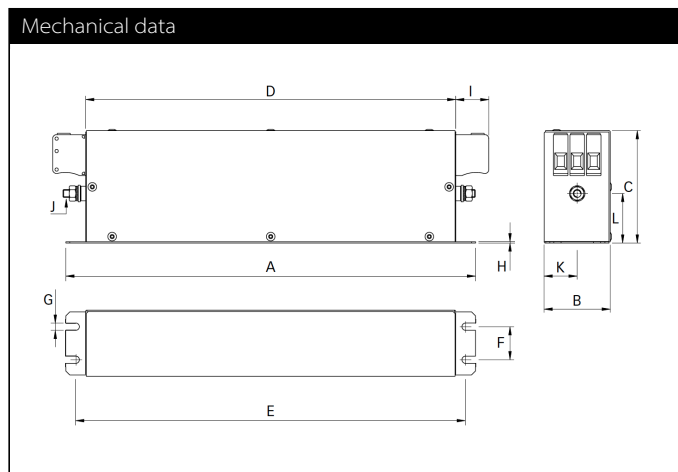

Note: in favour of a better readability, connectors and earth studs are not shown in the horizontal projection.

Dimensions

	7 A	16 A	30 A	42 A	55 A	75 A	100 A	130 A	180 A
A	190	250	270	310	250	270	270	270	380
B	40	45	50	50	85	80	90	90	120
C	70	70	85	85	90	135	150	150	170
D	160	220	240	280	220	240	240	240	350
E	180	235	255	295	235	255	255	255	365
F	20	25	30	30	60	60	65	65	102
G	4.5	5.4	5.4	5.4	5.4	6.5	6.5	6.5	6.5
H	1	1	1	1	1	1.5	1.5	1.5	1.5
I	22	22	25	25	39	39	45	45	51
J	M5	M5	M5	M6	M6	M6	M10	M10	M10
K	20	22.5	25	25	42.5	40	45	45	60
L2	29.5	29.5	39.5	37.5	26.5	70.5	64	64	47

All dimensions in mm; 1 inch = 25.4 mm

Tolerances according: ISO 2768-m/EN 22768-m

Filter input/output connector cross sections

	-33	-34	-35	-40	-44
Solid wire	16 mm ²	35 mm ²	50 mm ²	95 mm ²	10 mm ²
Flex wire	10 mm ²	25 mm ²	50 mm ²	95 mm ²	6 mm ²
AWG type wire	AWG 6	AWG 2	AWG 1/0	AWG 4/0	AWG 8
Recommended torque	1.5-1.8 Nm	4.0-4.5 Nm	7-8 Nm	17-20 Nm	1.0-1.2 Nm

Please visit www.schaffner.com to find more details on filter connectors.



Headquarters, global innovation and development

Switzerland

Schaffner Group

Industrie Nord
Nordstrasse 11e
4542 Luterbach
T +41 32 681 66 26
info@schaffner.com

To find your local partner within Schaffner's global network: www.schaffner.com

© 2018 Schaffner Group

The content of this document has been carefully checked and understood. However, neither Schaffner nor its subsidiaries assume any liability whatsoever for any errors or inaccuracies of this document and the consequences thereof. Published specifications are subject to change without notice. Product suitability for any area of application must ultimately be determined by the customer. In all cases, products must never be operated outside their published specifications. Schaffner does not guarantee the availability of all published products. This disclaimer shall be governed by substantive Swiss law and resulting disputes shall be settled by the courts at the place of business of Schaffner Holding AG. Latest publications and a complete disclaimer can be downloaded from the Schaffner website. All trademarks recognized.



Sales and application centers

China

Schaffner EMC Ltd. Shanghai

T20-3 C, No 565 Chuangye Road,
Pudong district
201201 Shanghai
T +86 21 3813 9500
cschina@schaffner.com
www.schaffner.com.cn

Finland

Schaffner Oy

Sauvonrinne 19 H
08500 Lohja
T +358 10 567 2855
finlandsales@schaffner.com

France

Schaffner EMC S.A.S.

16-20 Rue Louis Rameau
95875 Bezons
T +33 1 34 34 30 60
F +33 1 39 47 02 28
francesales@schaffner.com

Germany

Schaffner Deutschland GmbH

Schoemperlenstrasse 12B
76185 Karlsruhe
T +49 721 56910
F +49 721 569110
germanysales@schaffner.com

India

Schaffner India Pvt. Ltd

REGUS WORLD TRADE CENTRE
WTC, 22nd Floor Unit No 2238, Brigade
Gateway Campus, 26/1, Dr. Rajkumar Road
Malleshwaram (W)
560055 Bangalore
T +91 80 67935355
indiasales@schaffner.com

Italy

Schaffner EMC S.r.l.

Via Ticino, 30
20900 Monza (MB)
T +39 039 21 41 070
italysales@schaffner.com

Japan

Schaffner EMC K.K.

Taiju-Seimei Sangenjaya Bldg.
1-32-12, Kamiuma, Setagaya-ku
154-0011 Tokyo
T +81 3 5712 3650
F +81 3 5712 3651
japansales@schaffner.com
www.schaffner.jp

Singapore

Schaffner EMC Pte Ltd.

#05-09, Kg Ubi Ind. Estate
408705 Singapore
T +65 6377 3283
F +65 6377 3281
singaporesales@schaffner.com

Spain

Schaffner EMC España

Calle Caléndula 93, Miniparc III, Edificio E
El Soto de Moraleja, Alcobendas
28109 Madrid
T +34 917 912 900
F +34 917 912 901
spainsales@schaffner.com

Sweden

Schaffner EMC AB

Östermalmstorg 1
114 42 Stockholm
T +46 8 5050 2425
swedensales@schaffner.com
www.schaffner.com

Switzerland

Schaffner EMV AG

Industrie Nord
Nordstrasse 11e
4542 Luterbach
T +41 32 681 66 26
switzerlandsales@schaffner.com

Taiwan R.O.C.

Schaffner EMV Ltd.

20 Floor-2, No 97, Section 1, XinTai 5th Road
22175 XiZhi District New Taipei City 22175
T +886 2 2697 5500
F +886 2 2697 5533
taiwansales@schaffner.com
www.schaffner.com.tw

Thailand

Schaffner EMC Co. Ltd.

Northern Region Industrial Estate
67 Moo 4 Tambon Ban Klang
Amphur Muangng P.O. Box 14
51000 Lamphun
T +66 53 58 11 04
F +66 53 58 10 19
thailandsales@schaffner.com

United Kingdom

Schaffner Ltd.

1, Oakmede Place
Binfield
RG42 4JF Berkshire
T +44 118 9770070
F +44 118 9792969
uksales@schaffner.com

USA

Schaffner EMC Inc.

52 Mayfield Avenue
Edison, New Jersey
T +1 732 225 9533
F +1 732 225 4789
usasales@schaffner.com
www.schaffnerusa.com

Schaffner North America

6722 Thirlane Road
24019 Roanoke, Virginia
T +1 276 228 7943
F +1 276 228 7953

Schaffner North America

823 Fairview Road
24382 Wytheville, Virginia
T +1 276 228 7943
F +1 276 228 7258

Mouser Electronics

Authorized Distributor

Click to View Pricing, Inventory, Delivery & Lifecycle Information:

Schaffner:

[FN3258-30-47](#) [FN3258-16-45](#) [FN3258-130-35](#) [FN3258-180-40](#) [FN3258-42-47](#) [FN3258-7-45](#) [FN3258-7-44](#)
[FN3258-16-44](#) [FN3258-30-33](#) [FN3258-42-33](#) [FN3258-55-34](#) [FN3258-100-35](#) [FN3258H-7-44](#) [FN3258H-7-45](#)
[FN3258H-16-44](#) [FN3258H-16-45](#) [FN3258H-30-33](#) [FN3258H-30-47](#) [FN3258H-42-33](#) [FN3258H-42-47](#) [FN3258P-42-](#)
[47](#) [FN3258H-180-40](#) [FN3258-75-34](#) [FN3258H-130-35](#) [FN3258H-75-52](#) [FN3258-55-52](#) [FN3258H-55-34](#) [FN3258H-](#)
[55-52](#) [FN3258-75-52](#) [FN3258H-75-34](#) [FN3258H-100-35](#)