

# IRG4PH50UDPbF

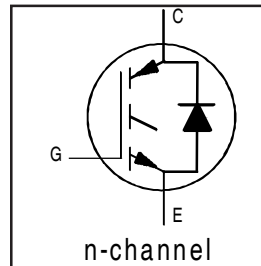
INSULATED GATE BIPOLAR TRANSISTOR WITH ULTRAFAST SOFT RECOVERY DIODE      UltraFast CoPack IGBT

## Features

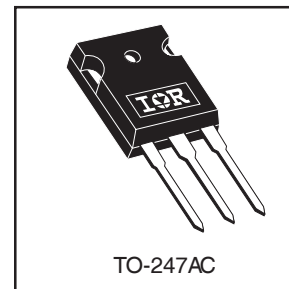
- UltraFast: Optimized for high operating frequencies up to 40 kHz in hard switching, >200 kHz in resonant mode
- New IGBT design provides tighter parameter distribution and higher efficiency than previous generations
- IGBT co-packaged with HEXFRED™ ultrafast, ultra-soft-recovery anti-parallel diodes for use in bridge configurations
- Industry standard TO-247AC package
- Lead-Free

## Benefits

- Higher switching frequency capability than competitive IGBTs
- Highest efficiency available
- HEXFRED diodes optimized for performance with IGBT's. Minimized recovery characteristics require less/no snubbing



$V_{CES} = 1200V$
$V_{CE(on)} \text{ typ.} = 2.78V$
@ $V_{GE} = 15V, I_C = 24A$



## Absolute Maximum Ratings

	Parameter	Max.	Units
$V_{CES}$	Collector-to-Emitter Breakdown Voltage	1200	V
$I_C @ T_C = 25^\circ C$	Continuous Collector Current	45	A
$I_C @ T_C = 100^\circ C$	Continuous Collector Current	24	
$I_{CM}$	Pulsed Collector Current ①	180	
$I_{LM}$	Clamped Inductive Load Current ②	180	
$I_F @ T_C = 100^\circ C$	Diode Continuous Forward Current	16	
$I_{FM}$	Diode Maximum Forward Current	180	
$V_{GE}$	Gate-to-Emitter Voltage	$\pm 20$	V
$P_D @ T_C = 25^\circ C$	Maximum Power Dissipation	200	W
$P_D @ T_C = 100^\circ C$	Maximum Power Dissipation	78	
$T_J$	Operating Junction and Storage Temperature Range	-55 to + 150	$^\circ C$
$T_{STG}$			
	Mounting torque, 6-32 or M3 screw.	10 lbf•in (1.1N•m)	

## Thermal Resistance

	Parameter	Min.	Typ.	Max.	Units
$R_{\theta JC}$	Junction-to-Case - IGBT	—	—	0.64	$^\circ C/W$
$R_{\theta JC}$	Junction-to-Case - Diode	—	—	0.83	
$R_{\theta CS}$	Case-to-Sink, flat, greased surface	—	0.24	—	
$R_{\theta JA}$	Junction-to-Ambient, typical socket mount	—	—	40	
$W_t$	Weight	—	6 (0.21)	—	g (oz)

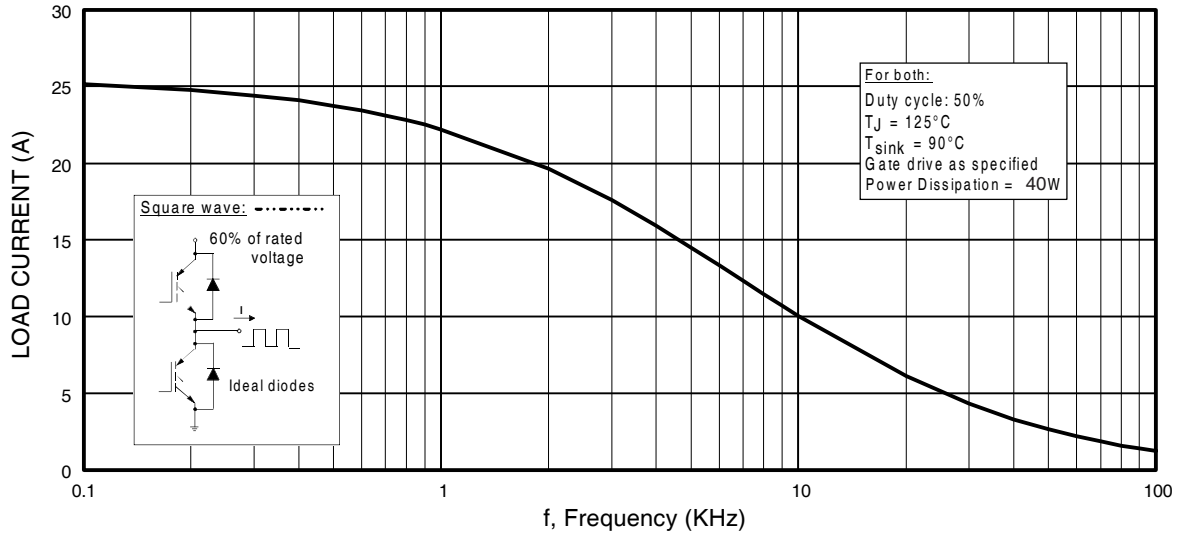
# IRG4PH50UDPbF

## Electrical Characteristics @ T<sub>J</sub> = 25°C (unless otherwise specified)

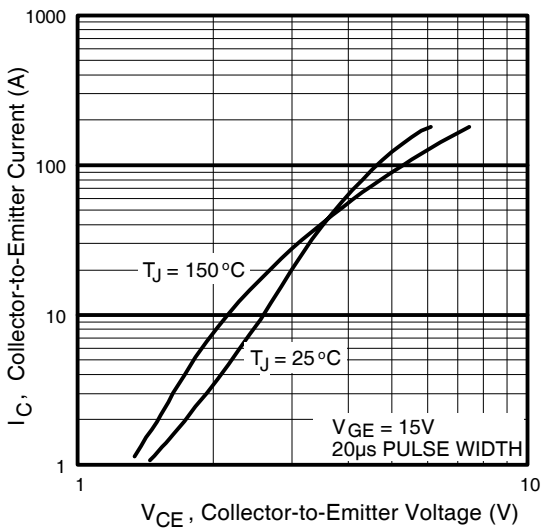
	Parameter	Min.	Typ.	Max.	Units	Conditions
V <sub>(BR)CES</sub>	Collector-to-Emitter Breakdown Voltage <sup>③</sup>	1200	—	—	V	V <sub>GE</sub> = 0V, I <sub>C</sub> = 250μA
ΔV <sub>(BR)CES</sub> /ΔT <sub>J</sub>	Temperature Coeff. of Breakdown Voltage	—	1.20	—	V/°C	V <sub>GE</sub> = 0V, I <sub>C</sub> = 1.0mA
V <sub>CE(on)</sub>	Collector-to-Emitter Saturation Voltage	—	2.56	3.5	V	I <sub>C</sub> = 20A V <sub>GE</sub> = 15V
		—	2.78	3.7		I <sub>C</sub> = 24A
		—	3.20	—		I <sub>C</sub> = 45A See Fig. 2, 5
		—	2.54	—		I <sub>C</sub> = 24A, T <sub>J</sub> = 150°C
V <sub>GE(th)</sub>	Gate Threshold Voltage	3.0	—	6.0		V <sub>CE</sub> = V <sub>GE</sub> , I <sub>C</sub> = 250μA
ΔV <sub>GE(th)</sub> /ΔT <sub>J</sub>	Temperature Coeff. of Threshold Voltage	—	-13	—	mV/°C	V <sub>CE</sub> = V <sub>GE</sub> , I <sub>C</sub> = 250μA
g <sub>fe</sub>	Forward Transconductance <sup>④</sup>	23	35	—	S	V <sub>CE</sub> = 100V, I <sub>C</sub> = 24A
I <sub>CES</sub>	Zero Gate Voltage Collector Current	—	—	250	μA	V <sub>GE</sub> = 0V, V <sub>CE</sub> = 1200V
		—	—	6500		V <sub>GE</sub> = 0V, V <sub>CE</sub> = 1200V, T <sub>J</sub> = 150°C
V <sub>FM</sub>	Diode Forward Voltage Drop	—	2.5	3.5	V	I <sub>C</sub> = 16A See Fig. 13
		—	2.1	3.0		I <sub>C</sub> = 16A, T <sub>J</sub> = 150°C
I <sub>GES</sub>	Gate-to-Emitter Leakage Current	—	—	±100	nA	V <sub>GE</sub> = ±20V

## Switching Characteristics @ T<sub>J</sub> = 25°C (unless otherwise specified)

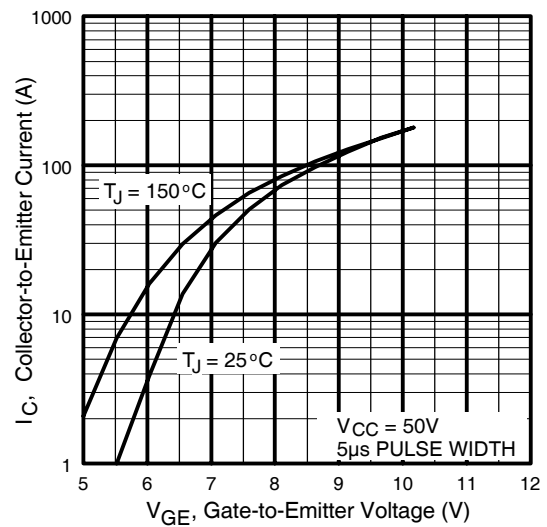
	Parameter	Min.	Typ.	Max.	Units	Conditions
Q <sub>g</sub>	Total Gate Charge (turn-on)	—	160	250	nC	I <sub>C</sub> = 24A V <sub>CC</sub> = 400V See Fig. 8 V <sub>GE</sub> = 15V
Q <sub>ge</sub>	Gate - Emitter Charge (turn-on)	—	27	40		
Q <sub>gc</sub>	Gate - Collector Charge (turn-on)	—	53	80		
t <sub>d(on)</sub>	Turn-On Delay Time	—	47	—	ns	T <sub>J</sub> = 25°C I <sub>C</sub> = 24A, V <sub>CC</sub> = 800V V <sub>GE</sub> = 15V, R <sub>G</sub> = 5.0Ω Energy losses include "tail" and diode reverse recovery. See Fig. 9, 10, 18
t <sub>r</sub>	Rise Time	—	24	—		
t <sub>d(off)</sub>	Turn-Off Delay Time	—	110	170		
t <sub>f</sub>	Fall Time	—	180	260		
E <sub>on</sub>	Turn-On Switching Loss	—	2.10	—	mJ	T <sub>J</sub> = 150°C, See Fig. 11, 18 I <sub>C</sub> = 24A, V <sub>CC</sub> = 800V V <sub>GE</sub> = 15V, R <sub>G</sub> = 5.0Ω Energy losses include "tail" and diode reverse recovery. See Fig. 9, 10, 18
E <sub>off</sub>	Turn-Off Switching Loss	—	1.50	—		
E <sub>ts</sub>	Total Switching Loss	—	3.60	4.6		
t <sub>d(on)</sub>	Turn-On Delay Time	—	46	—	ns	T <sub>J</sub> = 150°C, See Fig. 11, 18 I <sub>C</sub> = 24A, V <sub>CC</sub> = 800V V <sub>GE</sub> = 15V, R <sub>G</sub> = 5.0Ω Energy losses include "tail" and diode reverse recovery.
t <sub>r</sub>	Rise Time	—	27	—		
t <sub>d(off)</sub>	Turn-Off Delay Time	—	240	—		
t <sub>f</sub>	Fall Time	—	330	—		
E <sub>ts</sub>	Total Switching Loss	—	6.38	—	mJ	Measured 5mm from package
L <sub>E</sub>	Internal Emitter Inductance	—	13	—	nH	Measured 5mm from package
C <sub>ies</sub>	Input Capacitance	—	3600	—	pF	V <sub>GE</sub> = 0V V <sub>CC</sub> = 30V See Fig. 7 f = 1.0MHz
C <sub>oes</sub>	Output Capacitance	—	160	—		
C <sub>res</sub>	Reverse Transfer Capacitance	—	31	—		
t <sub>rr</sub>	Diode Reverse Recovery Time	—	90	135	ns	T <sub>J</sub> = 25°C See Fig. 14
		—	164	245		T <sub>J</sub> = 125°C
I <sub>rr</sub>	Diode Peak Reverse Recovery Current	—	5.8	10	A	T <sub>J</sub> = 25°C See Fig. 15
		—	8.3	15		T <sub>J</sub> = 125°C
Q <sub>rr</sub>	Diode Reverse Recovery Charge	—	260	675	nC	T <sub>J</sub> = 25°C See Fig. 16
		—	680	1838		T <sub>J</sub> = 125°C
di <sub>(rec)M</sub> /dt	Diode Peak Rate of Fall of Recovery During t <sub>b</sub>	—	120	—	A/μs	T <sub>J</sub> = 25°C See Fig. 17
		—	76	—		T <sub>J</sub> = 125°C



**Fig. 1** - Typical Load Current vs. Frequency  
 (Load Current =  $I_{\text{RMS}}$  of fundamental)

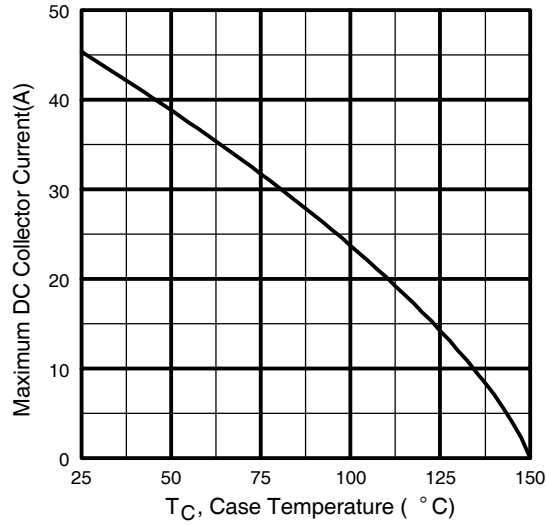


**Fig. 2** - Typical Output Characteristics  
[www.irf.com](http://www.irf.com)

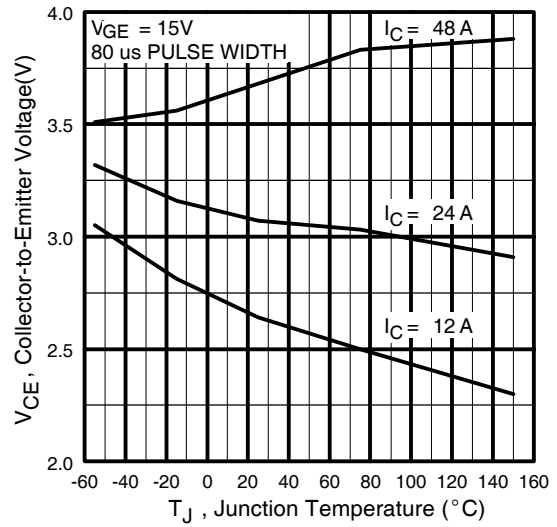


**Fig. 3** - Typical Transfer Characteristics

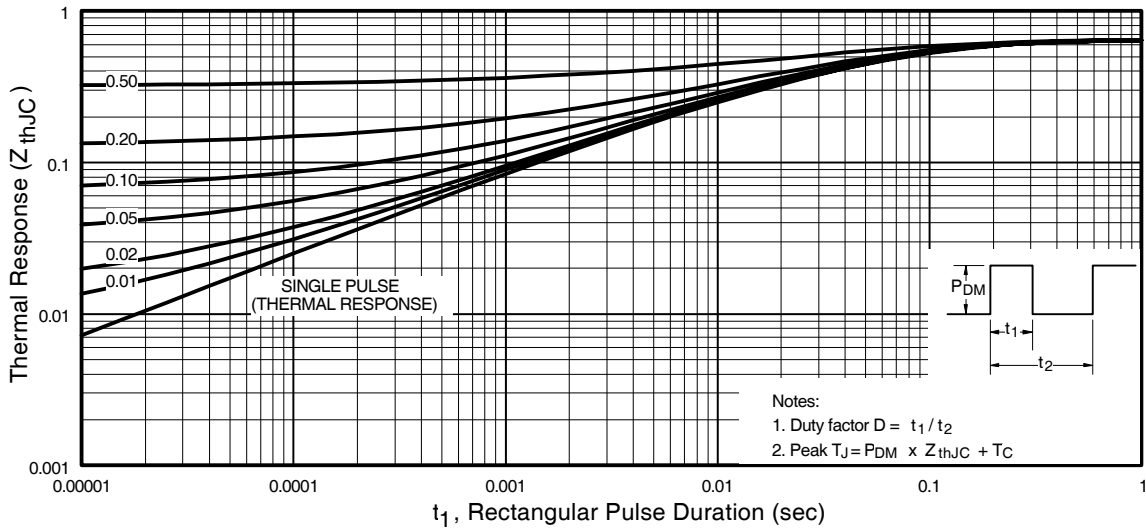
# IRG4PH50UDPbF



**Fig. 4** - Maximum Collector Current vs. Case Temperature

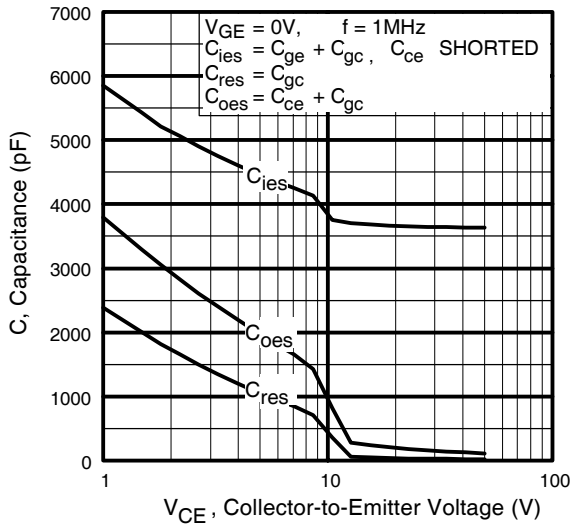


**Fig. 5** - Typical Collector-to-Emitter Voltage vs. Junction Temperature

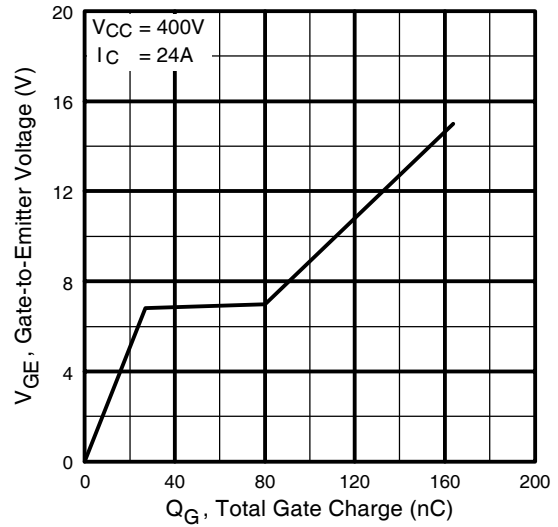


**Fig. 6** - Maximum Effective Transient Thermal Impedance, Junction-to-Case

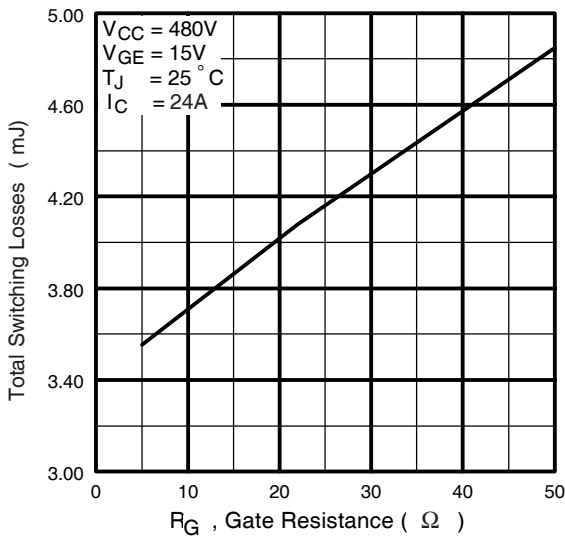
# IRG4PH50UDPbF



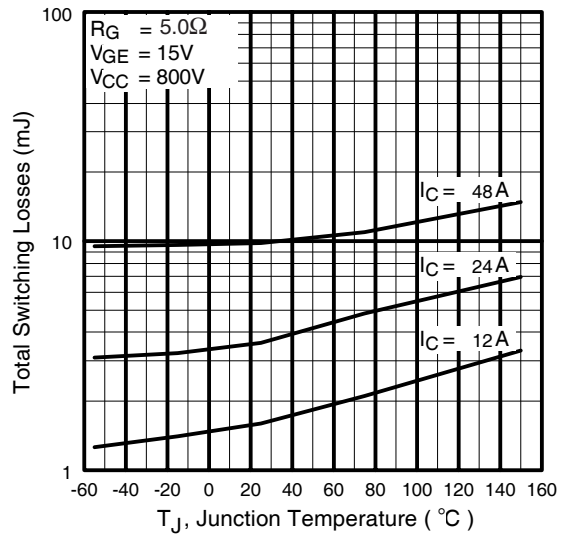
**Fig. 7** - Typical Capacitance vs. Collector-to-Emitter Voltage



**Fig. 8** - Typical Gate Charge vs. Gate-to-Emitter Voltage

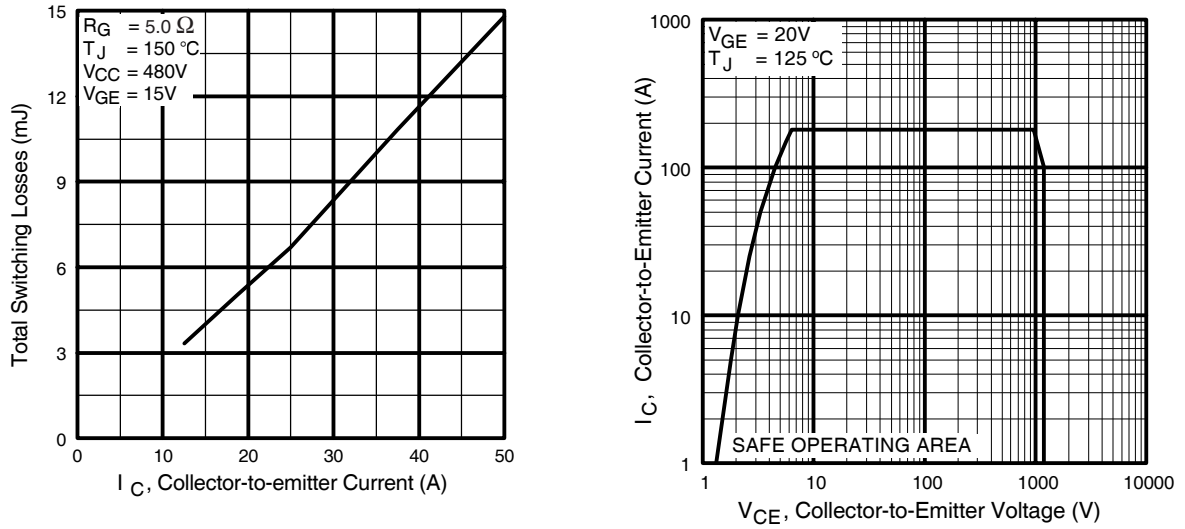


**Fig. 9** - Typical Switching Losses vs. Gate Resistance

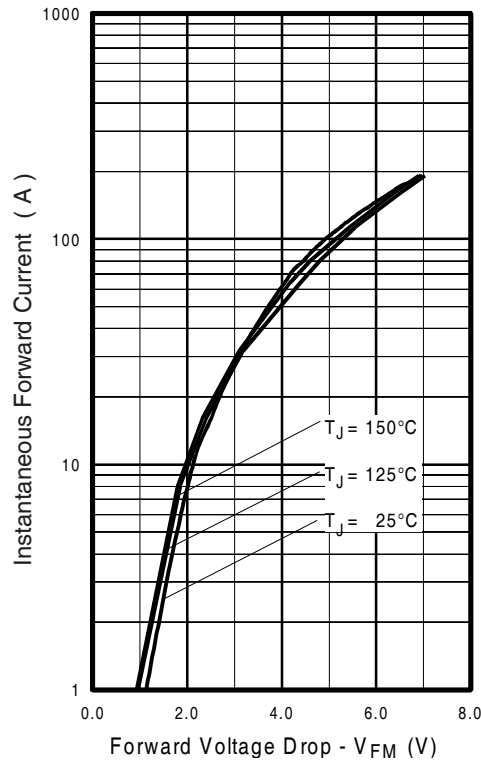


**Fig. 10** - Typical Switching Losses vs. Junction Temperature

# IRG4PH50UDPbF



**Fig. 11** - Typical Switching Losses vs. Collector-to-Emitter Current



**Fig. 13** - Typical Forward Voltage Drop vs. Instantaneous Forward Current

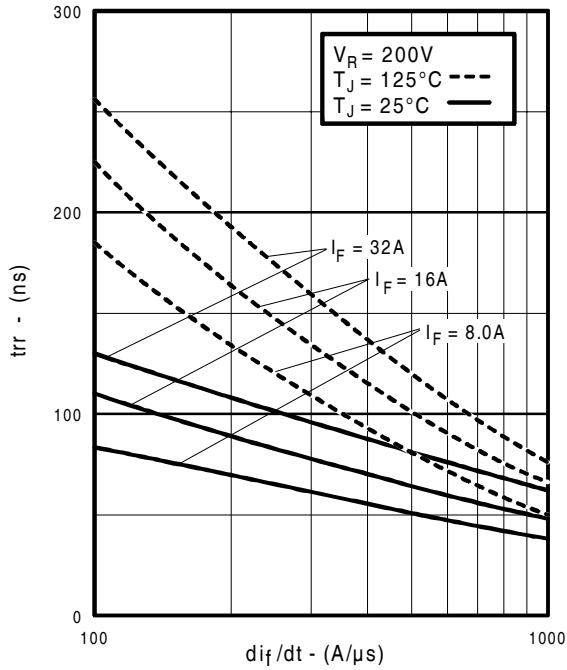


Fig. 14 - Typical Reverse Recovery vs.  $di_f/dt$

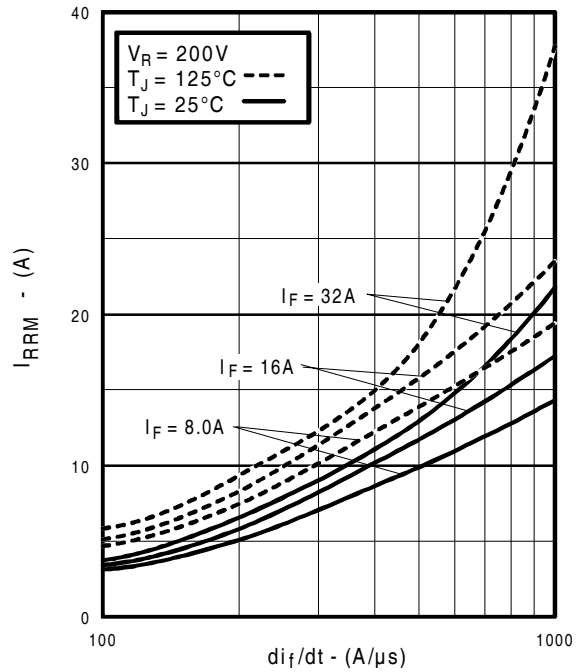


Fig. 15 - Typical Recovery Current vs.  $di_f/dt$

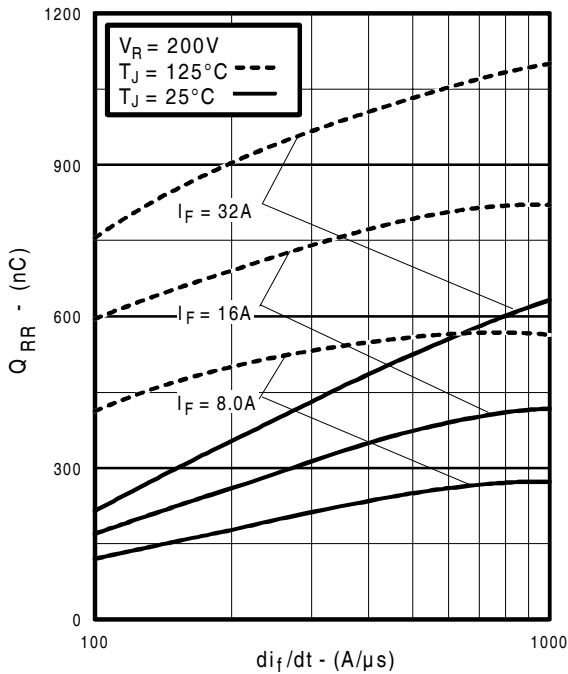


Fig. 16 - Typical Stored Charge vs.  $di_f/dt$   
www.irf.com

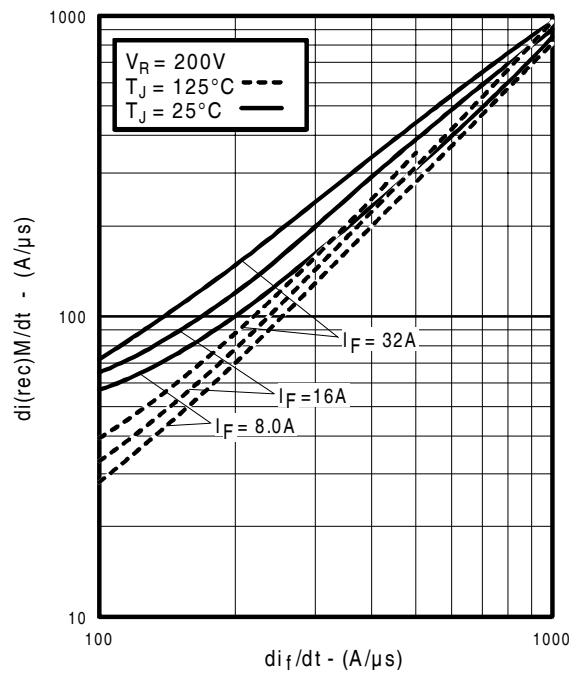
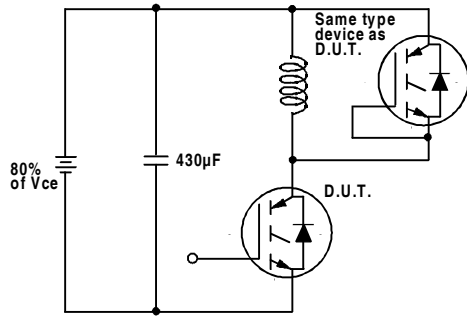
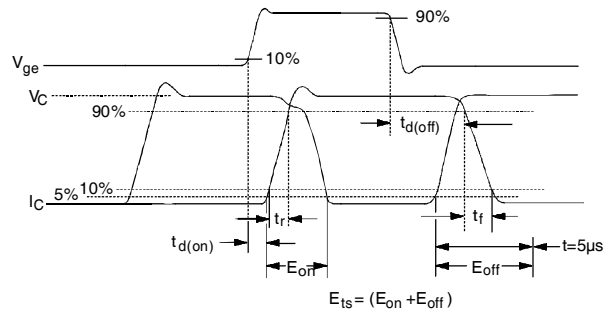


Fig. 17 - Typical  $di_{(rec)M}/dt$  vs.  $di_f/dt$

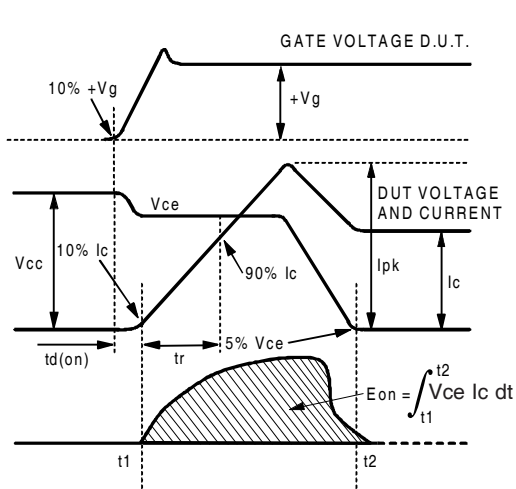
# IRG4PH50UDPbF



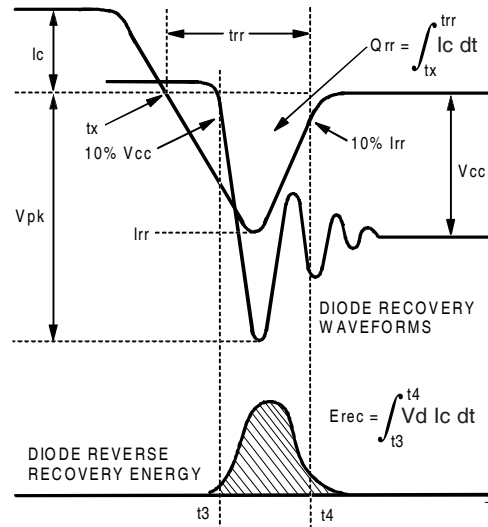
**Fig. 18a** - Test Circuit for Measurement of  $I_{LM}$ ,  $E_{on}$ ,  $E_{off}(\text{diode})$ ,  $t_{rr}$ ,  $Q_{rr}$ ,  $I_{rr}$ ,  $t_{d(on)}$ ,  $t_r$ ,  $t_{d(off)}$ ,  $t_f$



**Fig. 18b** - Test Waveforms for Circuit of Fig. 18a, Defining  $E_{off}$ ,  $t_{d(off)}$ ,  $t_f$



**Fig. 18c** - Test Waveforms for Circuit of Fig. 18a, Defining  $E_{on}$ ,  $t_{d(on)}$ ,  $t_r$



**Fig. 18d** - Test Waveforms for Circuit of Fig. 18a, Defining  $E_{rec}$ ,  $t_{rr}$ ,  $Q_{rr}$ ,  $I_{rr}$



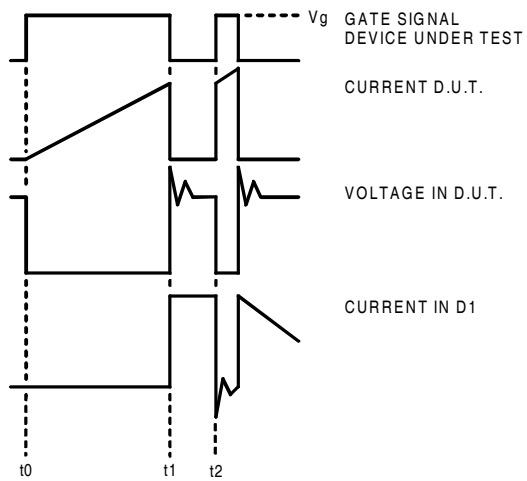


Figure 18e. Macro Waveforms for Figure 18a's Test Circuit

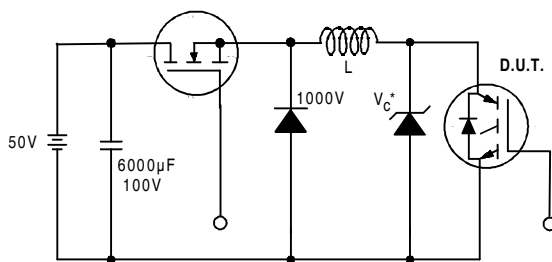


Figure 19. Clamped Inductive Load Test Circuit

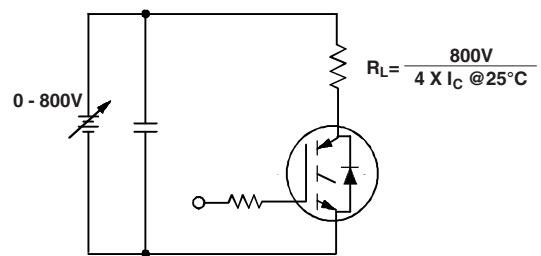


Figure 20. Pulsed Collector Current Test Circuit

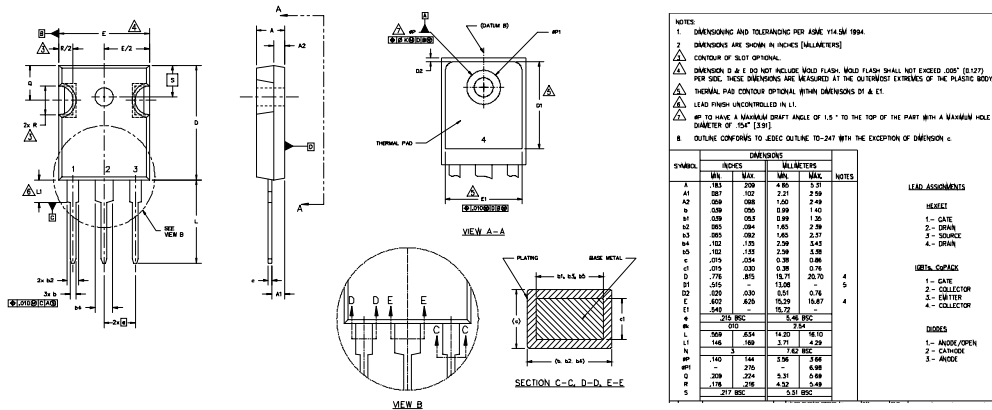
# IRG4PH50UDPbF

## Notes:

- ① Repetitive rating:  $V_{GE}=20V$ ; pulse width limited by maximum junction temperature (figure 20)
- ②  $V_{CC}=80\%(V_{CES})$ ,  $V_{GE}=20V$ ,  $L=10\mu H$ ,  $R_G=5.0\Omega$  (figure 19)
- ③ Pulse width  $\leq 80\mu s$ ; duty factor  $\leq 0.1\%$ .
- ④ Pulse width  $5.0\mu s$ , single shot.

## TO-247AC Package Outline

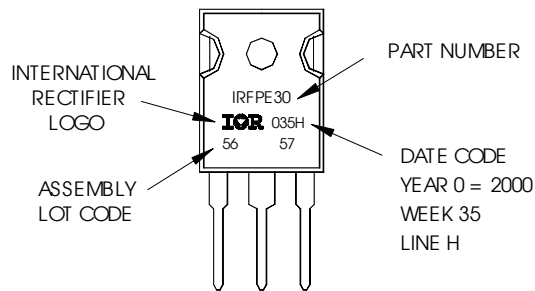
Dimensions are shown in millimeters (inches)



## TO-247AC Part Marking Information

EXAMPLE: THIS IS AN IRFP30  
WITH ASSEMBLY  
LOT CODE 5657  
ASSEMBLED ON WW 35, 2000  
IN THE ASSEMBLY LINE "H"

**Note:** "P" in assembly line position indicates "Lead-Free"



Data and specifications subject to change without notice.

Note: For the most current drawings please refer to the IR website at:  
<http://www.irf.com/package/>

# Mouser Electronics

Authorized Distributor

Click to View Pricing, Inventory, Delivery & Lifecycle Information:

[Infineon:](#)

[IRG4PH50UDPBF](#)