

CKTS	DIM A	DIM B
2	.200/5.08	.100/2.54
3	.300/7.62	.200/5.08
4	.400/10.16	.300/7.62
5	.500/12.70	.400/10.16
6	.600/15.24	.500/12.70
7	.700/17.78	.600/15.24
8	.800/20.32	.700/17.78
9	.900/22.86	.800/20.32
10	1.000/25.40	.900/22.86
11	1.100/27.94	1.000/25.40
12	1.200/30.48	1.100/27.94
13	1.300/33.02	1.200/30.48
14	1.400/35.56	1.300/33.02
15	1.500/38.10	1.400/35.56
16	1.600/40.64	1.500/38.10
17	1.700/43.18	1.600/40.64
18	1.800/45.72	1.700/43.18
19	1.900/48.26	1.800/45.72
20	2.000/50.80	1.900/48.26
21	2.100/53.34	2.000/50.80
22	2.200/55.88	2.100/53.34
23	2.300/58.42	2.200/55.88
24	2.400/60.96	2.300/58.42
25	2.500/63.50	2.400/60.96
26	2.600/66.04	2.500/63.50
27	2.700/68.58	2.600/66.04
28	2.800/71.12	2.700/68.58
29	2.900/73.66	2.800/71.12
30	3.000/76.20	2.900/73.66
31	3.100/78.74	3.000/76.20
32	3.200/81.28	3.100/78.74
33	3.300/83.82	3.200/81.28
34	3.400/86.36	3.300/83.82
35	3.500/88.90	3.400/86.36
36	3.600/91.44	3.500/88.90

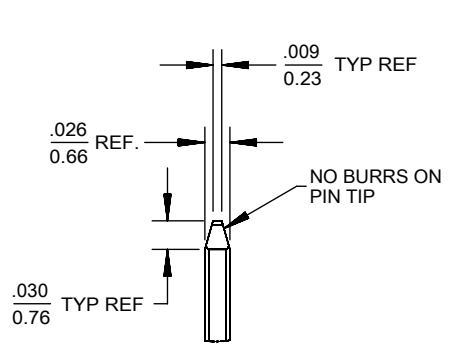

**DETAIL X**  
SCALE 5:1  
SEE NOTE 11

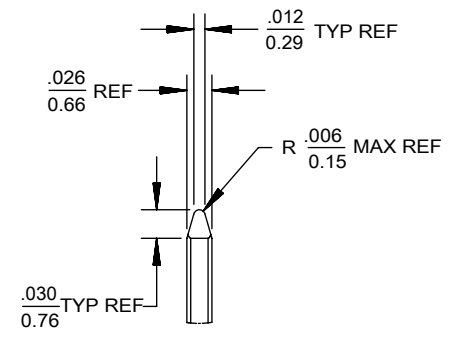

**DETAIL Y**  
SCALE 5:1  
SEE NOTE 11

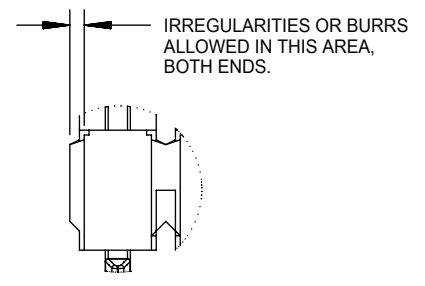

**DETAIL Z**  
SCALE 5:1

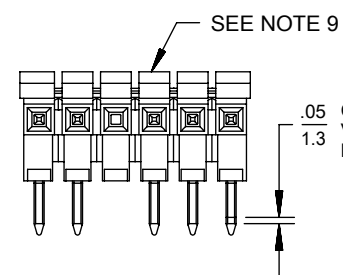
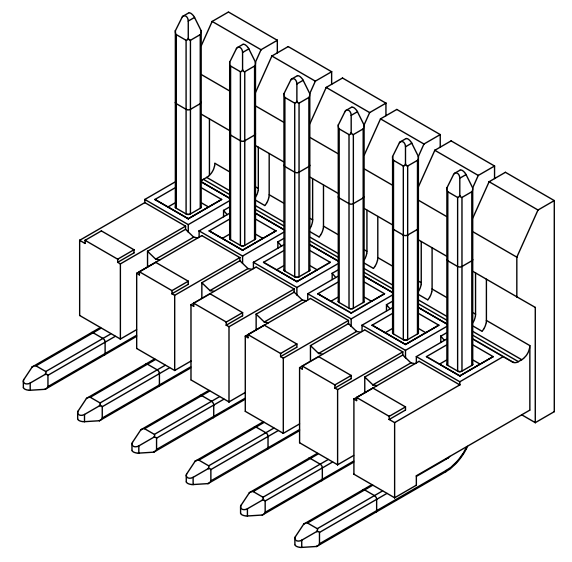

.05 CENTERLINE OF PIN IN AREA SHOWN NOT TO VARY FROM CENTERLINE OF PIN AT DATUM -E- BY MORE THAN .008/0.20 IN ANY DIRECTION.

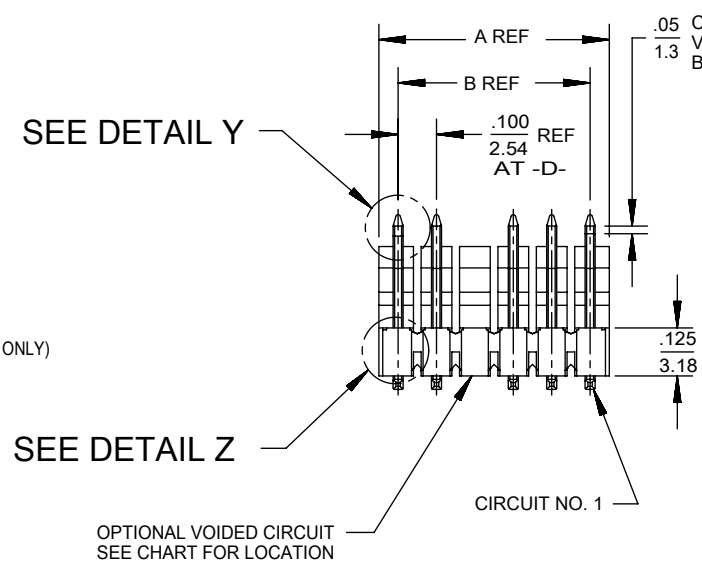

.05 CENTERLINE OF PIN IN AREA SHOWN NOT TO VARY FROM CENTERLINE OF PIN AT DATUM -D- BY MORE THAN .008/0.20 IN ANY DIRECTION.

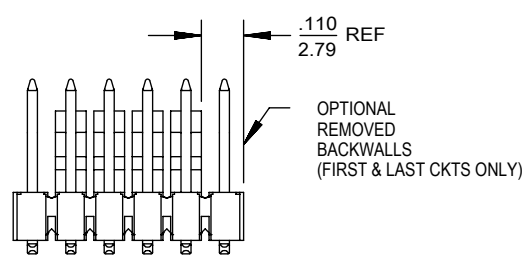
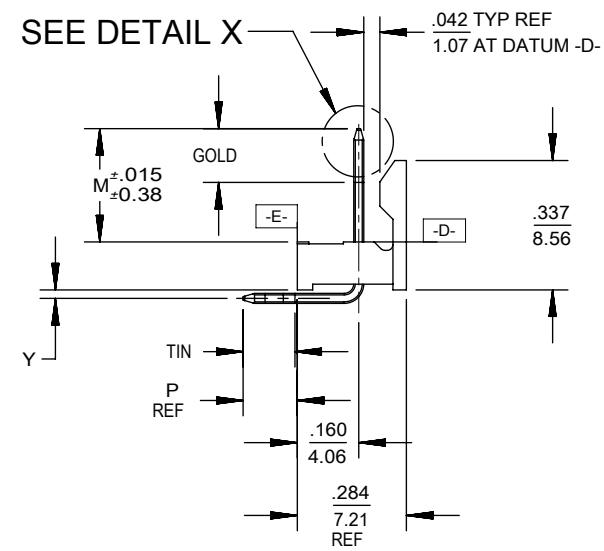

**REMOVED BACKWALLS OPTION**  
SEE NOTE 12

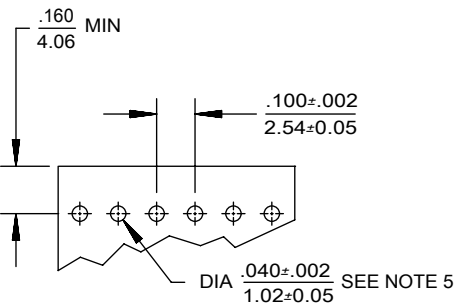

**RECOMMENDED PC BOARD LAYOUT**

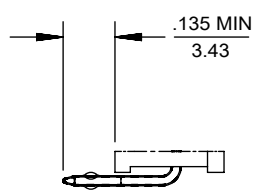

**KINKED PIN OPTION**  
SEE NOTE 5

- NOTES:**
- MATERIAL: GLASS FILLED NYLON, 94V-0, COLOR: BLACK
  - FINISH:
    - (154) OVERALL TIN: .000100/0.00254 MIN, OVER .000050/0.00127 MIN NICKEL.
    - (208) SELECT GOLD: .000015/0.00038 MIN, SELECT TIN: .000100/0.00254 MIN, OVERALL NICKEL UNDERPLATE: .000050/0.00127 MIN.
    - (228) SELECT GOLD: .000030/0.00076 MIN, SELECT TIN: .000100/0.00254 MIN, OVERALL NICKEL UNDERPLATE: .000050/0.00127 MIN.
  - PRODUCT SPECIFICATION: PS-10-07
  - PACKAGING INFORMATION: SEE TABLES
  - KINK PIN OPTION NOT RECOMMENDED FOR 2 CIRCUIT PARTS. HOLE SIZE MAY NEED TO BE ADJUSTED ON 2 CIRCUIT PARTS WITH KINK OPTION FOR PROPER INSERTION INTO THE PCB. SEE SMES-42003 FOR ADDITIONAL INFORMATION ON KINK PIN DIRECTION AND PLACEMENT.
  - HEADERS ARE NOT STACKABLE ON .100/2.54 CENTERS.
  - SOLDERABILITY PER SMES-152.
  - PIN PUSH OUT FORCE: 3 LBS. MIN.
  - ABRASION MARKS ON BACK WALL SURFACE ARE PERMISSIBLE.
  - PARTS CONFORM TO CLASS 'B' REQUIREMENTS OF COSMETIC SPECIFICATION PS-45499-002.
  - PIN TIP DIMENSIONS ARE SHOWN FOR REFERENCE ONLY. DIMENSIONS APPLY PRIOR TO PLATING OR ASSEMBLY.
  - FIRST AND LAST CIRCUIT BACKWALLS MUST BE REMOVED WHEN MATING TO A PART WITH POLARIZING RIBS.
  - TEXT ON PART IS FOR REFERENCE ONLY. TEXT AND TEXT LOCATION MAY VARY DEPENDING ON PART NUMBER AND/OR TOOL.

SYMBOLS		THIS DRAWING CONTAINS INFORMATION THAT IS PROPRIETARY TO MOLEX ELECTRONIC TECHNOLOGIES, LLC AND SHOULD NOT BE USED WITHOUT WRITTEN PERMISSION	
▽ = 0	IN/MM	SCALE	CURRENT REV DESC: ADDED NEW P/N
▽ = 0	GENERAL TOLERANCES (UNLESS SPECIFIED)	2:1	
▽ = 0		MM	INCH
▽ = 0	4 PLACES ±		
▽ = 0	3 PLACES ±	± 0.01	
▽ = 0	2 PLACES ±	± 0.014	
▽ = 0	1 PLACE ±	± 0.036	
▽ = 0	0 PLACES ±		
▽ = 0	ANGULAR TOL	± 0.5°	
▽ = 0	DRAFT WHERE APPLICABLE MUST REMAIN WITHIN DIMENSIONS		
▽ = 0	THIRD ANGLE PROJECTION	DRAWING	SERIES
		B-SIZE	42228
		MATERIAL NUMBER	CUSTOMER
		SEE CHART	GENERAL MARKET
			SHEET NUMBER
			1 OF 5

**molex**

.100 FRICTION LOCK  
BREAKAWAY HEADER ASSY

PRODUCT CUSTOMER DRAWING

DOCUMENT NUMBER: SD-42228-001  
DOC TYPE: PSD  
DOC PART: 001  
REVISION: L8

EC NO: 616614  
DRWN: SS06  
CHK'D: ISHWARG  
APPR: ISHWARG

INITIAL REVISION:  
DRWN: JSCHAFFER  
APPR: MARGULIS

DATE: 2019/05/07  
DATE: 2004/03/18

DATE: 2019/05/07  
DATE: 2004/03/18







A-42228-0002/0036					
HEADER NUMBER:		41411			
PIN NUMBER:		154			
PIN LENGTH: L		.705/17.91			
MATING LENGTH: M		.295/7.49			
GOLD POINT: G		N/A			
PC TAIL LENGTH: P		.120/3.05			
TIN: T		OVERALL			
DIMENSION Y		.022/0.56			
CKTS:		2-36			
KINKS:		NO			
REMOVED BACKWALLS:		NO			
VOIDED CKTS:		NONE			
PACKAGING:		BULK, PER PK-40873-0056			
CKTS	MATERIAL NUMBER	ENG NUMBER	CKTS	MATERIAL NUMBER	ENG NUMBER
02	22-28-1020	A-42228-0002	20	22-28-1200	A-42228-0020
03	22-28-1030	A-42228-0003	21	22-28-1210	A-42228-0021
04	22-28-1040	A-42228-0004	22	22-28-1220	A-42228-0022
05	22-28-1050	A-42228-0005	23	22-28-1230	A-42228-0023
06	22-28-1060	A-42228-0006	24	22-28-1240	A-42228-0024
07	22-28-1070	A-42228-0007	25	22-28-1250	A-42228-0025
08	22-28-1080	A-42228-0008	26	22-28-1260	A-42228-0026
09	22-28-1090	A-42228-0009	27	22-28-1270	A-42228-0027
10	22-28-1100	A-42228-0010	28	22-28-1280	A-42228-0028
11	22-28-1110	A-42228-0011	29	22-28-1290	A-42228-0029
12	22-28-1120	A-42228-0012	30	22-28-1300	A-42228-0030
13	22-28-1130	A-42228-0013	31	22-28-1310	A-42228-0031
14	22-28-1140	A-42228-0014	32	22-28-1320	A-42228-0032
15	22-28-1150	A-42228-0015	33	22-28-1330	A-42228-0033
16	22-28-1160	A-42228-0016	34	22-28-1340	A-42228-0034
17	22-28-1170	A-42228-0017	35	22-28-1350	A-42228-0035
18	22-28-1180	A-42228-0018	36	22-28-1360	A-42228-0036
19	22-28-1190	A-42228-0019			

A-42228-0037/0071					
HEADER NUMBER:		41411			
PIN NUMBER:		208			
PIN LENGTH: L		.705/17.91			
MATING LENGTH: M		.295/7.49			
GOLD POINT: G		.140/3.56			
PC TAIL LENGTH: P		.120/3.05			
TIN: T		.135/3.43			
DIMENSION Y		.022/0.56			
CKTS:		2-36			
KINKS:		NO			
REMOVED BACKWALLS:		NO			
VOIDED CKTS:		NONE			
PACKAGING:		BULK, PER PK-40873-0056			
CKTS	MATERIAL NUMBER	ENG NUMBER	CKTS	MATERIAL NUMBER	ENG NUMBER
02	22-28-1021	A-42228-0037	20	22-28-1201	A-42228-0055
03	22-28-1031	A-42228-0038	21	22-28-1211	A-42228-0056
04	22-28-1041	A-42228-0039	22	22-28-1221	A-42228-0057
05	22-28-1051	A-42228-0040	23	22-28-1231	A-42228-0058
06	22-28-1061	A-42228-0041	24	22-28-1241	A-42228-0059
07	22-28-1071	A-42228-0042	25	22-28-1251	A-42228-0060
08	22-28-1081	A-42228-0043	26	22-28-1261	A-42228-0061
09	22-28-1091	A-42228-0044	27	22-28-1271	A-42228-0062
10	22-28-1101	A-42228-0045	28	22-28-1281	A-42228-0063
11	22-28-1111	A-42228-0046	29	22-28-1291	A-42228-0064
12	22-28-1121	A-42228-0047	30	22-28-1301	A-42228-0065
13	22-28-1131	A-42228-0048	31	22-28-1311	A-42228-0066
14	22-28-1141	A-42228-0049	32	22-28-1321	A-42228-0067
15	22-28-1151	A-42228-0050	33	22-28-1332	A-42228-0068
16	22-28-1161	A-42228-0051	34	22-28-1341	A-42228-0069
17	22-28-1171	A-42228-0052	35	22-28-1351	A-42228-0070
18	22-28-1181	A-42228-0053	36	22-28-1361	A-42228-0071
19	22-28-1191	A-42228-0054			

<b>SYMBOLS</b> = 0 = 0 = 0 = 0 = 0 = 0 = 0 = 0 = 0	THIS DRAWING CONTAINS INFORMATION THAT IS PROPRIETARY TO MOLEX ELECTRONIC TECHNOLOGIES, LLC AND SHOULD NOT BE USED WITHOUT WRITTEN PERMISSION DIMENSION UNITS: <b>IN/MM</b> SCALE: <b>1:1</b>	CURRENT REV DESC: ADDED NEW P/N EC NO: 616614 DRWN: SS06 2018/06/15 CHK'D: ISHWARG 2019/05/07 APPR: ISHWARG 2019/05/07	 .100 FRICTION LOCK BREAKAWAY HEADER ASSY PRODUCT CUSTOMER DRAWING		
	GENERAL TOLERANCES (UNLESS SPECIFIED)	INITIAL REVISION: DRWN: JSCHAFFER 2004/03/18 APPR: MARGULIS 2004/03/18		DOCUMENT NUMBER: <b>SD-42228-001</b> DOC TYPE: PSD DOC PART: 001 REVISION: <b>L8</b>	
	4 PLACES ± 3 PLACES ± 0.01 2 PLACES ± 0.25 ± 0.014 1 PLACE ± 0.36 ± 0 PLACES ±	ANGULAR TOL ± 0.5° DRAFT WHERE APPLICABLE MUST REMAIN WITHIN DIMENSIONS		THIRD ANGLE PROJECTION DRAWING: <b>B-SIZE</b> SERIES: <b>42228</b>	MATERIAL NUMBER: SEE CHART CUSTOMER: GENERAL MARKET SHEET NUMBER: 2 OF 5
	DOCUMENT STATUS: P1   RELEASE DATE: 2019/05/07 07:09:04				

A-42228-0072/0106					
HEADER NUMBER:		41411			
PIN NUMBER:		228			
PIN LENGTH: L		.705/17.91			
MATING LENGTH: M		.295/7.49			
GOLD POINT: G		.140/3.56			
PC TAIL LENGTH: P		.120/3.05			
TIN: T		.135/3.43			
DIMENSION Y		.022/0.56			
CKTS:		2-36			
KINKS:		NO			
REMOVED BACKWALLS:		NO			
VOIDED CKTS:		NONE			
PACKAGING:		BULK, PER PK-40873-0056			
CKTS	MATERIAL NUMBER	ENG NUMBER	CKTS	MATERIAL NUMBER	ENG NUMBER
02	22-28-1022	A-42228-0072	20	22-28-1202	A-42228-0090
03	22-28-1032	A-42228-0073	21	22-28-1212	A-42228-0091
04	22-28-1042	A-42228-0074	22	22-28-1222	A-42228-0092
05	22-28-1052	A-42228-0075	23	22-28-1232	A-42228-0093
06	22-28-1062	A-42228-0076	24	22-28-1242	A-42228-0094
07	22-28-1072	A-42228-0077	25	22-28-1252	A-42228-0095
08	22-28-1082	A-42228-0078	26	22-28-1262	A-42228-0096
09	22-28-1092	A-42228-0079	27	22-28-1272	A-42228-0097
10	22-28-1102	A-42228-0080	28	22-28-1282	A-42228-0098
11	22-28-1112	A-42228-0081	29	22-28-1292	A-42228-0099
12	22-28-1122	A-42228-0082	30	22-28-1302	A-42228-0100
13	22-28-1132	A-42228-0083	31	22-28-1312	A-42228-0101
14	22-28-1142	A-42228-0084	32	22-28-1322	A-42228-0102
15	22-28-1152	A-42228-0085	33	22-28-1332	A-42228-0103
16	22-28-1162	A-42228-0086	34	22-28-1342	A-42228-0104
17	22-28-1172	A-42228-0087	35	22-28-1352	A-42228-0105
18	22-28-1182	A-42228-0088	36	22-28-1362	A-42228-0106
19	22-28-1192	A-42228-0089			

A-42228-0107/0141					
HEADER NUMBER:		41411			
PIN NUMBER:		154			
PIN LENGTH: L		.720/18.29			
MATING LENGTH: M		.295/7.49			
GOLD POINT: G		N/A			
PC TAIL LENGTH: P		.135/3.43			
TIN: T		OVERALL			
DIMENSION Y		.022/0.56			
CKTS:		2-36			
KINKS:		YES SMES-42003			
REMOVED BACKWALLS:		NO			
VOIDED CKTS:		NONE			
PACKAGING:		BULK, PER PK-40873-0056			
CKTS	MATERIAL NUMBER	ENG NUMBER	CKTS	MATERIAL NUMBER	ENG NUMBER
02	22-28-1023	A-42228-0107	20	22-28-1203	A-42228-0125
03	22-28-1033	A-42228-0108	21	22-28-1213	A-42228-0126
04	22-28-1043	A-42228-0109	22	22-28-1223	A-42228-0127
05	22-28-1053	A-42228-0110	23	22-28-1233	A-42228-0128
06	22-28-1063	A-42228-0111	24	22-28-1243	A-42228-0129
07	22-28-1073	A-42228-0112	25	22-28-1253	A-42228-0130
08	22-28-1083	A-42228-0113	26	22-28-1263	A-42228-0131
09	22-28-1093	A-42228-0114	27	22-28-1273	A-42228-0132
10	22-28-1103	A-42228-0115	28	22-28-1283	A-42228-0133
11	22-28-1113	A-42228-0116	29	22-28-1293	A-42228-0134
12	22-28-1123	A-42228-0117	30	22-28-1303	A-42228-0135
13	22-28-1133	A-42228-0118	31	22-28-1313	A-42228-0136
14	22-28-1143	A-42228-0119	32	22-28-1323	A-42228-0137
15	22-28-1153	A-42228-0120	33	22-28-1333	A-42228-0138
16	22-28-1163	A-42228-0121	34	22-28-1343	A-42228-0139
17	22-28-1173	A-42228-0122	35	22-28-1353	A-42228-0140
18	22-28-1183	A-42228-0123	36	22-28-1363	A-42228-0141
19	22-28-1193	A-42228-0124			

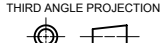
<b>SYMBOLS</b>  = 0  = 0  = 0  = 0  = 0  = 0	THIS DRAWING CONTAINS INFORMATION THAT IS PROPRIETARY TO MOLEX ELECTRONIC TECHNOLOGIES, LLC AND SHOULD NOT BE USED WITHOUT WRITTEN PERMISSION DIMENSION UNITS: <b>IN/MM</b> SCALE: <b>1:1</b>	CURRENT REV DESC: ADDED NEW P/N EC NO: 616614 DRWN: SS06 2018/06/15 CHK'D: ISHWARG 2019/05/07 APPR: ISHWARG 2019/05/07	 .100 FRICTION LOCK BREAKAWAY HEADER ASSY PRODUCT CUSTOMER DRAWING																			
	GENERAL TOLERANCES (UNLESS SPECIFIED) <table border="1"> <tr><th></th><th>MM</th><th>INCH</th></tr> <tr><td>4 PLACES</td><td>±</td><td>±</td></tr> <tr><td>3 PLACES</td><td>±</td><td>± 0.01</td></tr> <tr><td>2 PLACES</td><td>± 0.25</td><td>± 0.014</td></tr> <tr><td>1 PLACE</td><td>± 0.36</td><td>±</td></tr> <tr><td>0 PLACES</td><td>±</td><td>±</td></tr> </table>			MM	INCH	4 PLACES	±	±	3 PLACES	±	± 0.01	2 PLACES	± 0.25	± 0.014	1 PLACE	± 0.36	±	0 PLACES	±	±	INITIAL REVISION: DRWN: JSCHAFFER 2004/03/18 APPR: MARGULIS 2004/03/18	DOCUMENT NUMBER: <b>SD-42228-001</b> DOC TYPE: PSD DOC PART: 001 REVISION: <b>L8</b>
		MM		INCH																		
	4 PLACES	±		±																		
3 PLACES	±	± 0.01																				
2 PLACES	± 0.25	± 0.014																				
1 PLACE	± 0.36	±																				
0 PLACES	±	±																				
ANGULAR TOL ± 0.5° DRAFT WHERE APPLICABLE MUST REMAIN WITHIN DIMENSIONS	THIRD ANGLE PROJECTION 	DRAWING: <b>B-SIZE</b> SERIES: <b>42228</b>	MATERIAL NUMBER: SEE CHART CUSTOMER: GENERAL MARKET SHEET NUMBER: 3 OF 5																			

A-42228-0142/0176	
HEADER NUMBER:	41411
PIN NUMBER:	208
PIN LENGTH: L	.720/18.29
MATING LENGTH: M	.295/7.49
GOLD POINT: G	.140/3.56
PC TAIL LENGTH: P	.135/3.43
TIN: T	.135/3.43
DIMENSION Y	.022/0.56
CKTS:	2-36
KINKS:	YES SMES-42003
REMOVED BACKWALLS:	NO
VOIDED CKTS:	NONE
PACKAGING:	BULK, PER PK-40873-0056

CKTS	MATERIAL NUMBER	ENG NUMBER	CKTS	MATERIAL NUMBER	ENG NUMBER
02	22-28-1024	A-42228-0142	20	22-28-1204	A-42228-0160
03	22-28-1034	A-42228-0143	21	22-28-1214	A-42228-0161
04	22-28-1044	A-42228-0144	22	22-28-1224	A-42228-0162
05	22-28-1054	A-42228-0145	23	22-28-1234	A-42228-0163
06	22-28-1064	A-42228-0146	24	22-28-1244	A-42228-0164
07	22-28-1074	A-42228-0147	25	22-28-1254	A-42228-0165
08	22-28-1084	A-42228-0148	26	22-28-1264	A-42228-0166
09	22-28-1094	A-42228-0149	27	22-28-1274	A-42228-0167
10	22-28-1104	A-42228-0150	28	22-28-1284	A-42228-0168
11	22-28-1114	A-42228-0151	29	22-28-1294	A-42228-0169
12	22-28-1124	A-42228-0152	30	22-28-1304	A-42228-0170
13	22-28-1134	A-42228-0153	31	22-28-1314	A-42228-0171
14	22-28-1144	A-42228-0154	32	22-28-1324	A-42228-0172
15	22-28-1154	A-42228-0155	33	22-28-1334	A-42228-0173
16	22-28-1164	A-42228-0156	34	22-28-1344	A-42228-0174
17	22-28-1174	A-42228-0157	35	22-28-1354	A-42228-0175
18	22-28-1184	A-42228-0158	36	22-28-1364	A-42228-0176
19	22-28-1194	A-42228-0159			

A-42228-0177/0211	
HEADER NUMBER:	41411
PIN NUMBER:	228
PIN LENGTH: L	.720/18.29
MATING LENGTH: M	.295/7.49
GOLD POINT: G	.140/3.56
PC TAIL LENGTH: P	.135/3.43
TIN: T	.135/3.43
DIMENSION Y	.022/0.56
CKTS:	2-36
KINKS:	YES SMES-42003
REMOVED BACKWALLS:	NO
VOIDED CKTS:	NONE
PACKAGING:	BULK, PER PK-40873-0056

CKTS	MATERIAL NUMBER	ENG NUMBER	CKTS	MATERIAL NUMBER	ENG NUMBER
02	22-28-1025	A-42228-0177	20	22-28-1205	A-42228-0195
03	22-28-1035	A-42228-0178	21	22-28-1215	A-42228-0196
04	22-28-1045	A-42228-0179	22	22-28-1225	A-42228-0197
05	22-28-1055	A-42228-0180	23	22-28-1235	A-42228-0198
06	22-28-1065	A-42228-0181	24	22-28-1245	A-42228-0199
07	22-28-1075	A-42228-0182	25	22-28-1255	A-42228-0200
08	22-28-1085	A-42228-0183	26	22-28-1265	A-42228-0201
09	22-28-1095	A-42228-0184	27	22-28-1275	A-42228-0202
10	22-28-1105	A-42228-0185	28	22-28-1285	A-42228-0203
11	22-28-1115	A-42228-0186	29	22-28-1295	A-42228-0204
12	22-28-1125	A-42228-0187	30	22-28-1305	A-42228-0205
13	22-28-1135	A-42228-0188	31	22-28-1315	A-42228-0206
14	22-28-1145	A-42228-0189	32	22-28-1325	A-42228-0207
15	22-28-1155	A-42228-0190	33	22-28-1335	A-42228-0208
16	22-28-1165	A-42228-0191	34	22-28-1345	A-42228-0209
17	22-28-1175	A-42228-0192	35	22-28-1355	A-42228-0210
18	22-28-1185	A-42228-0193	36	22-28-1365	A-42228-0211
19	22-28-1195	A-42228-0194			

<b>SYMBOLS</b> = 0 = 0 = 0 = 0 = 0 = 0 = 0 = 0 = 0	THIS DRAWING CONTAINS INFORMATION THAT IS PROPRIETARY TO MOLEX ELECTRONIC TECHNOLOGIES, LLC AND SHOULD NOT BE USED WITHOUT WRITTEN PERMISSION DIMENSION UNITS: <b>IN/MM</b> SCALE: <b>1:1</b>	CURRENT REV DESC: ADDED NEW P/N EC NO: 616614 DRWN: SS06 2018/06/15 CHK'D: ISHWARG 2019/05/07 APPR: ISHWARG 2019/05/07	 .100 FRICTION LOCK BREAKAWAY HEADER ASSY PRODUCT CUSTOMER DRAWING		
	GENERAL TOLERANCES (UNLESS SPECIFIED)	INITIAL REVISION: DRWN: JSCHAFFER 2004/03/18 APPR: MARGULIS 2004/03/18		DOCUMENT NUMBER: <b>SD-42228-001</b> DOC TYPE: PSD DOC PART: 001 REVISION: <b>L8</b>	
	4 PLACES ± 3 PLACES ± 0.01 2 PLACES ± 0.25 ± 0.014 1 PLACE ± 0.36 ± 0 PLACES ±	ANGULAR TOL ± 0.5° DRAFT WHERE APPLICABLE MUST REMAIN WITHIN DIMENSIONS		THIRD ANGLE PROJECTION DRAWING: <b>B-SIZE</b> SERIES: <b>42228</b>	MATERIAL NUMBER: SEE CHART CUSTOMER: GENERAL MARKET SHEET NUMBER: 4 OF 5
	DOCUMENT STATUS   P1   RELEASE DATE   2019/05/07 07:09:04				

A-42228-0212/0246	
HEADER NUMBER:	41411
PIN NUMBER:	154
PIN LENGTH: L	.705/17.91
MATING LENGTH: M	.295/7.49
GOLD POINT: G	N/A
PC TAIL LENGTH: P	.120/3.05
TIN: T	OVERALL
DIMENSION Y	.022/0.56
CKTS:	2-36
KINKS:	NO
REMOVED BACKWALLS:	NO
VOIDED CKTS:	NONE
PACKAGING:	TAPE AND REEL, 422281000-PK

CKTS	MATERIAL NUMBER	ENG NUMBER	CKTS	MATERIAL NUMBER	ENG NUMBER
02			20		
03	42228-0213	A-42228-0213	21		
04			22		
05			23		
06			24		
07			25		
08			26		
09			27		
10			28		
11			29		
12			30		
13			31		
14			32		
15			33		
16			34		
17			35		
18			36		
19					

SYMBOLS	THIS DRAWING CONTAINS INFORMATION THAT IS PROPRIETARY TO MOLEX ELECTRONIC TECHNOLOGIES, LLC AND SHOULD NOT BE USED WITHOUT WRITTEN PERMISSION		
	DIMENSION UNITS	SCALE	CURRENT REV DESC: ADDED NEW P/N
= 0	IN/MM	1:1	<b>molex</b> .100 FRICTION LOCK BREAKAWAY HEADER ASSY PRODUCT CUSTOMER DRAWING
= 0	GENERAL TOLERANCES (UNLESS SPECIFIED)		
= 0			
= 0			
= 0	4 PLACES ±		EC NO: 616614
= 0	3 PLACES ±	± 0.01	DRWN: SS06 2018/06/15
= 0	2 PLACES ±	± 0.014	CHK'D: ISHWARG 2019/05/07
= 0	1 PLACE ±	± 0.36	APPR: ISHWARG 2019/05/07
= 0	0 PLACES ±		INITIAL REVISION:
= 0	ANGULAR TOL ±	± 0.5°	DRWN: JSCHAFFER 2004/03/18
= 0	DRAFT WHERE APPLICABLE MUST REMAIN WITHIN DIMENSIONS	THIRD ANGLE PROJECTION	APPR: MARGULIS 2004/03/18
= 0		DRAWING	SERIES
		B-SIZE	42228
		MATERIAL NUMBER	CUSTOMER
		SEE CHART	GENERAL MARKET
		DOCUMENT NUMBER	DOC TYPE   DOC PART   REVISION
		SD-42228-001	PSD   001   L8
		SHEET NUMBER	5 OF 5

--

A-42228-0002/0036	
HEADER NUMBER:	41411
PLATING:	154
PIN LENGTH: L	.705/17.91
MATING LENGTH: M	.295/7.49
GOLD POINT: G	N/A
PC TAIL LENGTH: P	.120/3.05
TIN: T	OVERALL
DIMENSION Y	.022/0.56
CKTS:	2-36
KINKS:	NO
REMOVED BACKWALLS:	NO
VOIDED CKTS:	NONE
PACKAGING:	BULK, PER PK-40873-0056

CKTS	MATERIAL NUMBER	ENG NUMBER	CKTS	MATERIAL NUMBER	ENG NUMBER
02	22-28-1020	A-42228-0002	20	22-28-1200	A-42228-0020
03	22-28-1030	A-42228-0003	21	22-28-1210	A-42228-0021
04	22-28-1040	A-42228-0004	22	22-28-1220	A-42228-0022
05	22-28-1050	A-42228-0005	23	22-28-1230	A-42228-0023
06	22-28-1060	A-42228-0006	24	22-28-1240	A-42228-0024
07	22-28-1070	A-42228-0007	25	22-28-1250	A-42228-0025
08	22-28-1080	A-42228-0008	26	22-28-1260	A-42228-0026
09	22-28-1090	A-42228-0009	27	22-28-1270	A-42228-0027
10	22-28-1100	A-42228-0010	28	22-28-1280	A-42227-0028
11	22-28-1110	A-42228-0011	29	22-28-1290	A-42228-0029
12	22-28-1120	A-42228-0012	30	22-28-1300	A-42228-0030
13	22-28-1130	A-42228-0013	31	22-28-1310	A-42228-0031
14	22-28-1140	A-42228-0014	32	22-28-1320	A-42228-0032
15	22-28-1150	A-42228-0015	33	22-28-1330	A-42228-0033
16	22-28-1160	A-42228-0016	34	22-28-1340	A-42228-0034
17	22-28-1170	A-42228-0017	35	22-28-1350	A-42228-0035
18	22-28-1180	A-42228-0018	36	22-28-1360	A-42228-0036
19	22-28-1190	A-42228-0019			

A-42228-0037/0071	
HEADER NUMBER:	41411
PLATING:	208
PIN LENGTH: L	.705/17.91
MATING LENGTH: M	.295/7.49
GOLD POINT: G	.140/3.56
PC TAIL LENGTH: P	.120/3.05
TIN: T	.135/3.43
DIMENSION Y	.022/0.56
CKTS:	2-36
KINKS:	NO
REMOVED BACKWALLS:	NO
VOIDED CKTS:	NONE
PACKAGING:	BULK, PER PK-40873-0056

CKTS	MATERIAL NUMBER	ENG NUMBER	CKTS	MATERIAL NUMBER	ENG NUMBER
02	22-28-1021	A-42228-0037	20	22-28-1201	A-42228-0055
03	22-28-1031	A-42228-0038	21	22-28-1211	A-42228-0056
04	22-28-1041	A-42228-0039	22	22-28-1221	A-42228-0057
05	22-28-1051	A-42228-0040	23	22-28-1231	A-42228-0058
06	22-28-1061	A-42228-0041	24	22-28-1241	A-42228-0059
07	22-28-1071	A-42228-0042	25	22-28-1251	A-42228-0060
08	22-28-1081	A-42228-0043	26	22-28-1261	A-42228-0061
09	22-28-1091	A-42228-0044	27	22-28-1271	A-42228-0062
10	22-28-1101	A-42228-0045	28	22-28-1281	A-42228-0063
11	22-28-1111	A-42228-0046	29	22-28-1291	A-42228-0064
12	22-28-1121	A-42228-0047	30	22-28-1301	A-42228-0065
13	22-28-1131	A-42228-0048	31	22-28-1311	A-42228-0066
14	22-28-1141	A-42228-0049	32	22-28-1321	A-42228-0067
15	22-28-1151	A-42228-0050	33	22-28-1331	A-42228-0068
16	22-28-1161	A-42228-0051	34	22-28-1341	A-42228-0069
17	22-28-1171	A-42228-0052	35	22-28-1351	A-42228-0070
18	22-28-1181	A-42228-0053	36	22-28-1361	A-42228-0071
19	22-28-1191	A-42228-0054			

REV: <b>L5</b>	ECR/ECN INFORMATION EC No. <b>UCP2012-3374</b> DATE <b>10/12/2012</b>	TITLE: <b>.100 FRICTION LOCK BREAKAWAY HEADER ASSY.</b>	SHEET No. <b>- 2 -</b>
DOCUMENT NUMBER: <b>SD- 42228 -001</b>	CREATED / REVISED BY: <b>MKIPPER</b>	CHECKED BY: <b>JBELL</b>	APPROVED BY: <b>FSMITH-ROEMER</b>

--

A-42228-0072/0106					
HEADER NUMBER:		41411			
PLATING:		228			
PIN LENGTH: L		.705/17.91			
MATING LENGTH: M		.295/7.49			
GOLD POINT: G		.140/3.56			
PC TAIL LENGTH: P		.120/3.05			
TIN: T		.135/3.43			
DIMENSION Y		.022/0.56			
CKTS:		2-36			
KINKS:		NO			
REMOVED BACKWALLS:		NO			
VOIDED CKTS:		NONE			
PACKAGING:		BULK, PER PK-40873-0056			

CKTS	MATERIAL NUMBER	ENG NUMBER	CKTS	MATERIAL NUMBER	ENG NUMBER
02	22-28-1022	A-42228-0072	20	22-28-1202	A-42228-0090
03	22-28-1032	A-42228-0073	21	22-28-1212	A-42228-0091
04	22-28-1042	A-42228-0074	22	22-28-1222	A-42228-0092
05	22-28-1052	A-42228-0075	23	22-28-1232	A-42228-0093
06	22-28-1062	A-42228-0076	24	22-28-1242	A-42228-0094
07	22-28-1072	A-42228-0077	25	22-28-1252	A-42228-0095
08	22-28-1082	A-42228-0078	26	22-28-1262	A-42228-0096
09	22-28-1092	A-42228-0079	27	22-28-1272	A-42228-0097
10	22-28-1102	A-42228-0080	28	22-28-1282	A-42228-0098
11	22-28-1112	A-42228-0081	29	22-28-1292	A-42228-0099
12	22-28-1122	A-42228-0082	30	22-28-1302	A-42228-0100
13	22-28-1132	A-42228-0083	31	22-28-1312	A-42228-0101
14	22-28-1142	A-42228-0084	32	22-28-1322	A-42228-0102
15	22-28-1152	A-42228-0085	33	22-28-1332	A-42228-0103
16	22-28-1162	A-42228-0086	34	22-28-1342	A-42228-0104
17	22-28-1172	A-42228-0087	35	22-28-1352	A-42228-0105
18	22-28-1182	A-42228-0088	36	22-28-1362	A-42228-0106
19	22-28-1192	A-42228-0089			

A-42228-0107/0141					
HEADER NUMBER:		41411			
PLATING:		154			
PIN LENGTH: L		.720/18.29			
MATING LENGTH: M		.295/7.49			
GOLD POINT: G		N/A			
PC TAIL LENGTH: P		.135/3.43			
TIN: T		OVERALL			
DIMENSION Y		.022/0.56			
CKTS:		2-36			
KINKS:		YES SMES-42003			
REMOVED BACKWALLS:		NO			
VOIDED CKTS:		NONE			
PACKAGING:		BULK, PER PK-40873-0056			

CKTS	MATERIAL NUMBER	ENG NUMBER	CKTS	MATERIAL NUMBER	ENG NUMBER
02	22-28-1023	A-42228-0107	20	22-28-1203	A-42228-0125
03	22-28-1033	A-42228-0108	21	22-28-1213	A-42228-0126
04	22-28-1043	A-42228-0109	22	22-28-1223	A-42228-0127
05	22-28-1053	A-42228-0110	23	22-28-2233	A-42228-0128
06	22-28-1063	A-42228-0111	24	22-28-1243	A-42228-0129
07	22-28-1073	A-42228-0112	25	22-28-1253	A-42228-0130
08	22-28-1083	A-42228-0113	26	22-28-1263	A-42228-0131
09	22-28-1093	A-42228-0114	27	22-28-1273	A-42228-0132
10	22-28-1103	A-42228-0115	28	22-28-1283	A-42228-0133
11	22-28-1113	A-42228-0116	29	22-28-1293	A-42228-0134
12	22-28-1123	A-42228-0117	30	22-28-1303	A-42228-0135
13	22-28-1133	A-42228-0118	31	22-28-1313	A-42228-0136
14	22-28-1143	A-42228-0119	32	22-28-1323	A-42228-0137
15	22-28-1153	A-42228-0120	33	22-28-1333	A-42228-0138
16	22-28-1163	A-42228-0121	34	22-28-1343	A-42228-0139
17	22-28-1173	A-42228-0122	35	22-28-1353	A-42228-0140
18	22-28-1183	A-42228-0123	36	22-28-1363	A-42228-0141
19	22-28-1193	A-42228-0124			

REV:	<u>ECR/ECN INFORMATION</u>	<u>TITLE:</u>	<u>SHEET No.</u>
<b>L5</b>	EC No. <b>UCP2012-3374</b>	<b>.100 FRICTION LOCK BREAKAWAY HEADER ASSY.</b>	<b>- 3 -</b>
	DATE <b>10/12/2012</b>		
<u>DOCUMENT NUMBER:</u>	<u>CREATED / REVISED BY:</u>	<u>CHECKED BY:</u>	<u>APPROVED BY:</u>
<b>SD- 42228 -001</b>	<b>MKIPPER</b>	<b>JBELL</b>	<b>FSMITH-ROEMER</b>



A-42228-0142/0176					
HEADER NUMBER:	41411				
PLATING:	208				
PIN LENGTH: L	.720/18.29				
MATING LENGTH: M	.295/7.49				
GOLD POINT: G	.140/3.56				
PC TAIL LENGTH: P	.135/3.43				
TIN: T	.135/3.43				
DIMENSION Y	.022/0.56				
CKTS:	2-36				
KINKS:	YES SMES-42003				
REMOVED BACKWALLS:	NO				
VOIDED CKTS:	NONE				
PACKAGING:	BULK, PER PK-40873-0056				
CKTS	MATERIAL NUMBER	ENG NUMBER	CKTS	MATERIAL NUMBER	ENG NUMBER
02	22-28-1024	A-42228-0142	20	22-28-1204	A-42228-0160
03	22-28-1034	A-42228-0143	21	22-28-1214	A-42228-0161
04	22-28-1044	A-42228-0144	22	22-28-1224	A-42228-0162
05	22-28-1054	A-42228-0145	23	22-28-1234	A-42228-0163
06	22-28-1064	A-42228-0146	24	22-28-1244	A-42228-0164
07	22-28-1074	A-42228-0147	25	22-28-1254	A-42228-0165
08	22-28-1084	A-42228-0148	26	22-28-1264	A-42228-0166
09	22-28-1094	A-42228-0149	27	22-28-1274	A-42228-0167
10	22-28-1104	A-42228-0150	28	22-28-1284	A-42228-0168
11	22-28-1114	A-42228-0151	29	22-28-1294	A-42228-0169
12	22-28-1124	A-42228-0152	30	22-28-1304	A-42228-0170
13	22-28-1134	A-42228-0153	31	22-28-1314	A-42228-0171
14	22-28-1144	A-42228-0154	32	22-28-1324	A-42228-0172
15	22-28-1154	A-42228-0155	33	22-28-1334	A-42228-0173
16	22-28-1164	A-42228-0156	34	22-28-1344	A-42228-0174
17	22-28-1174	A-42228-0157	35	22-28-1354	A-42228-0175
18	22-28-1184	A-42228-0158	36	22-28-1364	A-42228-0176
19	22-28-1194	A-42228-0159			

A-42228-0177/0211					
HEADER NUMBER:	41411				
PLATING:	228				
PIN LENGTH: L	.720/18.29				
MATING LENGTH: M	.295/7.49				
GOLD POINT: G	.140/3.56				
PC TAIL LENGTH: P	.135/3.43				
TIN: T	.135/3.43				
DIMENSION Y	.022/0.56				
CKTS:	2-36				
KINKS:	YES SMES-42003				
REMOVED BACKWALLS:	NO				
VOIDED CKTS:	NONE				
PACKAGING:	BULK, PER PK-40873-0056				
CKTS	MATERIAL NUMBER	ENG NUMBER	CKTS	MATERIAL NUMBER	ENG NUMBER
02	22-28-1025	A-42228-0177	20	22-28-1205	A-42228-0195
03	22-28-1035	A-42228-0178	21	22-28-1215	A-42228-0196
04	22-28-1045	A-42228-0179	22	22-28-1225	A-42228-0197
05	22-28-1055	A-42228-0180	23	22-28-2235	A-42228-0198
06	22-28-1065	A-42228-0181	24	22-28-1245	A-42228-0199
07	22-28-1075	A-42228-0182	25	22-28-1255	A-42228-0200
08	22-28-1085	A-42228-0183	26	22-28-1265	A-42228-0201
09	22-28-1095	A-42228-0184	27	22-28-1275	A-42228-0202
10	22-28-1105	A-42228-0185	28	22-28-1285	A-42228-0203
11	22-28-1115	A-42228-0186	29	22-28-1295	A-42228-0204
12	22-28-1125	A-42228-0187	30	22-28-1305	A-42228-0205
13	22-28-1135	A-42228-0188	31	22-28-1315	A-42228-0206
14	22-28-1145	A-42228-0189	32	22-28-1325	A-42228-0207
15	22-28-1155	A-42228-0190	33	22-28-1335	A-42228-0208
16	22-28-1165	A-42228-0191	34	22-28-1345	A-42228-0209
17	22-28-1175	A-42228-0192	35	22-28-1355	A-42228-0210
18	22-28-1185	A-42228-0193	36	22-28-1365	A-42228-0211
19	22-28-1195	A-42228-0194			

REV:	<u>ECR/ECN INFORMATION</u>	<u>TITLE:</u>	<u>SHEET No.</u>
<b>L5</b>	EC No. <b>UCP2012-3374</b>	<b>.100 FRICTION LOCK BREAKAWAY HEADER ASSY.</b>	<b>- 4 -</b>
	DATE <b>10/12/2012</b>		
<u>DOCUMENT NUMBER:</u>	<u>CREATED / REVISED BY:</u>	<u>CHECKED BY:</u>	<u>APPROVED BY:</u>
<b>SD- 42228 -001</b>	<b>MKIPPER</b>	<b>JBELL</b>	<b>FSMITH-ROEMER</b>