



FRACTIONAL-N PLL WITH INTEGRATED VCO 45 - 1050, 1400 - 2100, 2800 - 4200 MHz

General Description

The is a low noise, wide band, Fractional-N Phase-Locked-Loop (PLL) that features an integrated Voltage Controlled Oscillator (VCO) with a fundamental frequency of 2800 MHz - 4200 MHz, and an integrated VCO Output Divider (divide by 1/2/4/6.../60/62), that together allow the to generate frequencies from 45 MHz to 1050 MHz, from 1400 MHz to 2100 MHz, and from 2800 MHz to 4200 MHz. The integrated Phase Detector (PD) and delta-sigma modulator, capable of operating at up to 100 MHz, permit wider loop-bandwidths with excellent spectral performance.

The features industry leading phase noise and spurious performance, across all frequencies, that enable it to minimize blocker effects, and improve receiver sensitivity and transmitter spectral purity. The superior noise floor (< -170 dBc/Hz) makes the an ideal source for a variety of applications - such as; LO for RF mixers, a clock source for high-frequency data-converters, or a tunable reference source for ultra-low spurious applications.

Additional features of the include RF output power control from 0 to 6 dB (~2 dB steps), output Mute function, and a delta-sigma modulator Exact Frequency Mode which enables users to generate output frequencies with 0 Hz frequency error.

For theory of operation and register map refer to the [“PLLs with Integrated VCOs - RF VCOs Operating Guide”](#). To view the Operating Guide, please visit www.hittite.com and choose from the “Search by Part Number” pull down menu.

Electrical Specifications

VPPCP, VDDLs, VCC1, VCC2 = 5V; RVDD, AVDD, DVDD3V, VCCPD, VCCHF, VCCPS = 3.3V
Min and Max Specified across Temp -40 °C to 85 °C

| Parameter | Condition | Min. | Typ. | Max. | Units |
|---|--|------|-------------|---------|-------|
| RF Output Characteristics | | | | | |
| Output Frequency | Band 1 | 45 | | 1050 | MHz |
| | Band 2 | 1400 | | 2100 | MHz |
| | Band 3 | 2800 | | 4200 | MHz |
| VCO Frequency at PLL Input | | 2800 | | 4200 | MHz |
| RF Output Frequency at f_{VCO} | | 2800 | | 4200 | MHz |
| Output Power | | | | | |
| RF Output Power at $f_{VCO} = 4000$ MHz Across All Frequencies see Figure 9 | Single-ended Power Broadband Matched Internally [1] | 1 | 3 | 4.3 | dBm |
| Output Power Control | ~2 dB Steps | 6 | | 7.5 | dB |
| Harmonics | | | | | |
| fo Mode at 4000 MHz | 2nd / 3rd / 4th | | -25/-29/-38 | | dBc |
| fo/2 Mode at 4000 MHz/2 = 2 GHz | 2nd / 3rd / 4th | | -25/-24/-35 | | dBc |
| fo/30 Mode at 2800 MHz/28 = 100 MHz | 2nd / 3rd / 4th | | -20/-10/-26 | | dBc |
| fo/62 Mode at 2800 MHz/62 = 45 MHz | 2nd / 3rd / 4th | | -14/-8/-21 | | dBc |
| VCO Output Divider | | | | | |
| VCO RF Divider Range | 1,2,4,6,8,...,62 | 1 | | 62 | |
| PLL RF Divider Characteristics | | | | | |
| 19-Bit N-Divider Range (Integer) | Max = $2^{19} - 1$ | 16 | | 524,287 | |
| 19-Bit N-Divider Range (Fractional) | Fractional nominal divide ratio varies (-3 / +4) dynamically max | 20 | | 524,283 | |

[1] Measured single-ended. Additional 3 dB possible with differential outputs.

[2] Measured with 100 Ω external termination. See [Hittite PLL w/ Integrated VCOs Operating Guide](#) Reference Input Stage section for more details.



FRACTIONAL-N PLL WITH INTEGRATED VCO 45 - 1050, 1400 - 2100, 2800 - 4200 MHz

Electrical Specifications (Continued)

| Parameter | Condition | Min. | Typ. | Max. | Units |
|--|--|------|------|--------|--------|
| REF Input Characteristics | | | | | |
| Max Ref Input Frequency | | | | 350 | MHz |
| Ref Input Voltage | AC Coupled [2] | 1 | 2 | 3.3 | Vp-p |
| Ref Input Capacitance | | | | 5 | pF |
| 14-Bit R-Divider Range | | 1 | | 16,383 | |
| Phase Detector (PD) [3] | | | | | |
| PD Frequency Fractional Mode B | [4] | DC | | 100 | MHz |
| PD Frequency Fractional Mode A (and Register 6 [17:16] = 11) | | DC | | 80 | MHz |
| PD Frequency Integer Mode | | DC | | 125 | MHz |
| Charge Pump | | | | | |
| Output Current | | 0.02 | | 2.54 | mA |
| Charge Pump Gain Step Size | | | 20 | | μA |
| PD/Charge Pump SSB Phase Noise | 50 MHz Ref, Input Referred | | | | |
| 1 kHz | | | -143 | | dBc/Hz |
| 10 kHz | Add 1 dB for Fractional | | -150 | | dBc/Hz |
| 100 kHz | Add 3 dB for Fractional | | -153 | | dBc/Hz |
| Logic Inputs | | | | | |
| Vsw | | 40 | 50 | 60 | % DVDD |
| Logic Outputs | | | | | |
| VOH Output High Voltage | | | DVDD | | V |
| VOL Output Low Voltage | | | 0 | | V |
| Output Impedance | | 100 | | 200 | Ω |
| Maximum Load Current | | | | 1.5 | mA |
| Power Supply Voltages | | | | | |
| 3.3 V Supplies | AVDD, VCCHF, VCCPS, VCCPD, RVDD, DVDD | 3.0 | 3.3 | 3.5 | V |
| 5 V Supplies | VPPCP, VDDLs, VCC1, VCC2 | 4.8 | 5 | 5.2 | V |
| Power Supply Currents | | | | | |
| +5V Analog Charge Pump | VPPCP, VDDLs | | 8 | | mA |
| +5V VCO Core and VCO Buffer | fo/1 Mode VCC2 | | 105 | | mA |
| | fo/N Mode VCC2 | | 80 | | mA |
| +5V VCO Divider and RF/PLL Buffer | Single-Ended Output Mode fo/1 Mode VCC1 | | 25 | | mA |
| | Differential Output Mode fo/1 Mode VCC1 | | 40 | | mA |
| | Single-Ended Output Mode fo/N Mode VCC1 | 80 | | 100 | mA |
| | Differential Output Mode fo/N Mode VCC1 | 95 | | 115 | mA |

[3] Slew rate of greater or equal to 0.5 ns/V is recommended, see [PLL with Integrated RF VCOs Operating Guide](#) for more details. Frequency is guaranteed across process voltage and temperature from -40 °C to 85 °C.

[4] This maximum phase detector frequency can only be achieved if the minimum N value is respected. eg. In the case of fractional feedback mode, the maximum PFD rate = $f_{vco}/20$ or 100 MHz, whichever is less.

Information furnished by Analog Devices is believed to be accurate and reliable. However, no responsibility is assumed by Analog Devices for its use, nor for any infringements of patents or other rights of third parties that may result from its use. Specifications subject to change without notice. No license is granted by implication or otherwise under any patent or patent rights of Analog Devices. Trademarks and registered trademarks are the property of their respective owners.

For price, delivery, and to place orders: Analog Devices, Inc., One Technology Way, P.O. Box 9106, Norwood, MA 02062-9106
Phone: 781-329-4700 • Order online at www.analog.com
Application Support: Phone: 1-800-ANALOG-D



FRACTIONAL-N PLL WITH INTEGRATED VCO 45 - 1050, 1400 - 2100, 2800 - 4200 MHz

Electrical Specifications (Continued)

| Parameter | Condition | Min. | Typ. | Max. | Units |
|---|---|------|--------|------|--------|
| +3.3V | AVDD, VCCHF, VCCPS, VCCPD, RVDD, DVDD3V | | 52 | | mA |
| Power Down - Crystal Off | Reg 01h=0, Crystal Not Clocked | | 10 | | μA |
| Power Down - Crystal On, 100 MHz | Reg01h =0, Crystal Clocked 100 MHz | | 10 | 30 | mA |
| Power on Reset | | | | | |
| Typical Reset Voltage on DVDD | | | 700 | | mV |
| Min DVDD Voltage for No Reset | | 1.5 | | | V |
| Power on Reset Delay | | | 250 | | μs |
| VCO Open Loop Phase Noise at fo @ 4 GHz | | | | | |
| 10 kHz Offset | | | -78 | | dBc/Hz |
| 100 kHz Offset | | | -108 | | dBc/Hz |
| 1 MHz Offset | | | -134.5 | | dBc/Hz |
| 10 MHz Offset | | | -156 | | dBc/Hz |
| 100 MHz Offset | | | -171 | | dBc/Hz |
| VCO Open Loop Phase Noise at fo @ 4 GHz/2 = 2 GHz | | | | | |
| 10 kHz Offset | | | -83 | | dBc/Hz |
| 100 kHz Offset | | | -113 | | dBc/Hz |
| 1 MHz Offset | | | -139.5 | | dBc/Hz |
| 10 MHz Offset | | | -165.5 | | dBc/Hz |
| 100 MHz Offset | | | -167 | | dBc/Hz |
| VCO Open Loop Phase Noise at fo @ 2.8 GHz/28 = 100 MHz | | | | | |
| 10 kHz Offset | | | -111 | | dBc/Hz |
| 100 kHz Offset | | | -141 | | dBc/Hz |
| 1 MHz Offset | | | -163.5 | | dBc/Hz |
| 10 MHz Offset | | | -170 | | dBc/Hz |
| 100 MHz Offset | | | -173 | | dBc/Hz |
| Figure of Merit | | | | | |
| Floor Integer Mode | Normalized to 1 Hz | | -230 | | dBc/Hz |
| Floor Fractional Mode | Normalized to 1 Hz | | -227 | | dBc/Hz |
| Flicker (Both Modes) | Normalized to 1 Hz | | -268 | | dBc/Hz |
| VCO Characteristics | | | | | |
| VCO Tuning Sensitivity at 4053 MHz | Measured at 2.5 V | | 15 | | MHz/V |
| VCO Tuning Sensitivity at 3777 MHz | Measured at 2.5 V | | 13 | | MHz/V |
| VCO Tuning Sensitivity at 3411 MHz | Measured at 2.5 V | | 12 | | MHz/V |
| VCO Tuning Sensitivity at 2943 MHz | Measured at 2.5 V | | 11.5 | | MHz/V |
| VCO Supply Pushing | Measured at 2.5 V | | 2 | | MHz/V |



FRACTIONAL-N PLL WITH INTEGRATED VCO
45 - 1050, 1400 - 2100, 2800 - 4200 MHz

PLLs WITH INTEGRATED VCO - SMT

Figure 1. Typical Closed Loop Integer Phase Noise ["Loop Filter Configuration Table"]

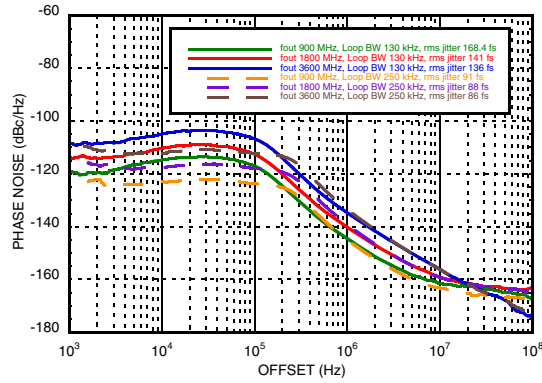

Figure 2. Typical Closed Loop Fractional Phase Noise ["Loop Filter Configuration Table"]

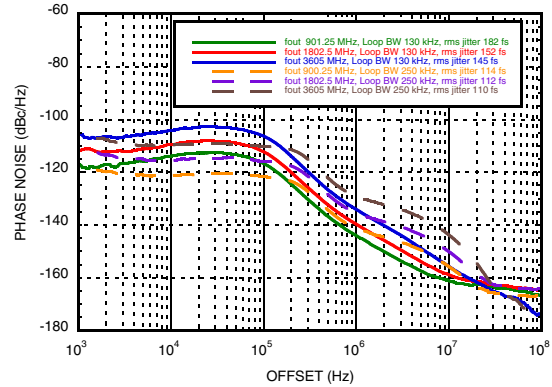

Figure 3. Free Running Phase Noise

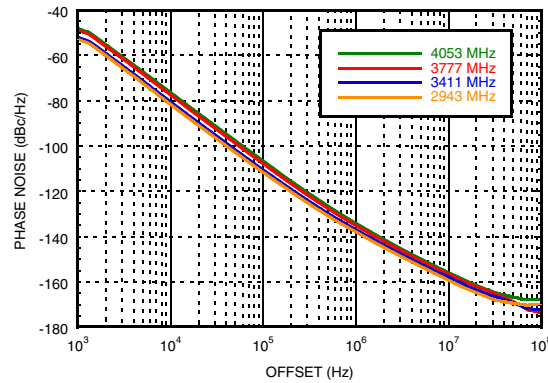

Figure 4. Free Running VCO Phase Noise vs. Temperature

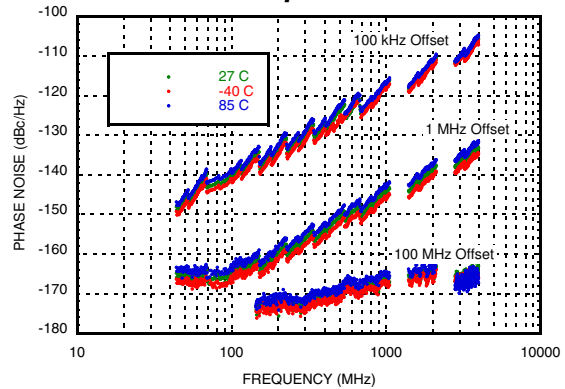

Figure 5. Typical VCO Sensitivity

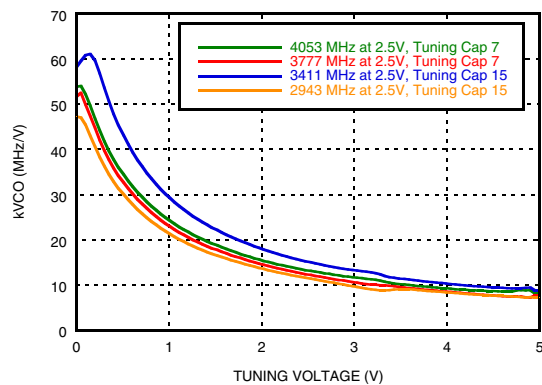
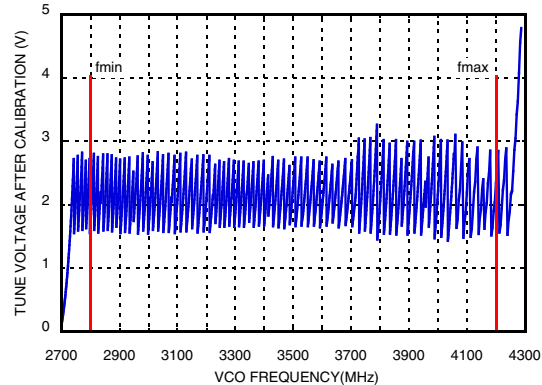

Figure 6. Typical Tuning Voltage After Calibration



Information furnished by Analog Devices is believed to be accurate and reliable. However, no responsibility is assumed by Analog Devices for its use, nor for any infringements of patents or other rights of third parties that may result from its use. Specifications subject to change without notice. No license is granted by implication or otherwise under any patent or patent rights of Analog Devices. Trademarks and registered trademarks are the property of their respective owners.

For price, delivery, and to place orders: Analog Devices, Inc., One Technology Way, P.O. Box 9106, Norwood, MA 02062-9106 Phone: 781-329-4700 • Order online at www.analog.com Application Support: Phone: 1-800-ANALOG-D

**FRACTIONAL-N PLL WITH INTEGRATED VCO
45 - 1050, 1400 - 2100, 2800 - 4200 MHz**



Figure 7. Integrated RMS Jitter^[1]

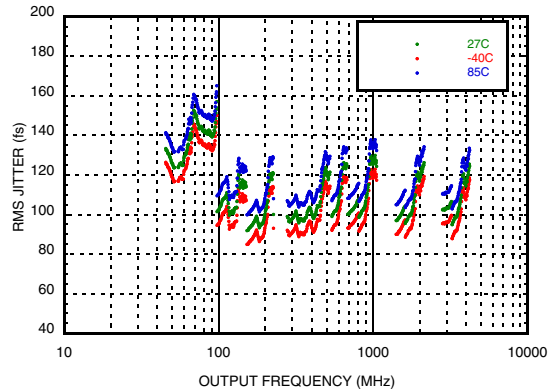

Figure 8. Figure of Merit

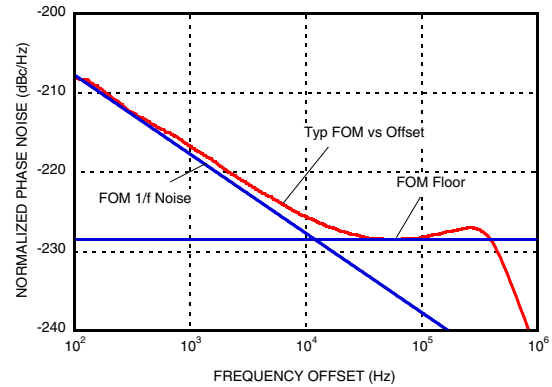

Figure 9. Typical Single-Ended Output Power

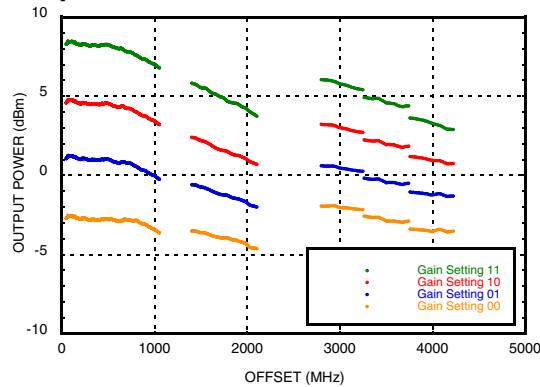

Figure 10. Typical Single-Ended Output Power vs. Temperature, Maximum Gain

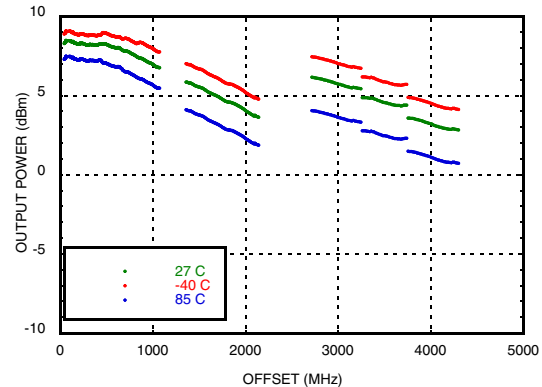

Figure 11. RF Output Return Loss

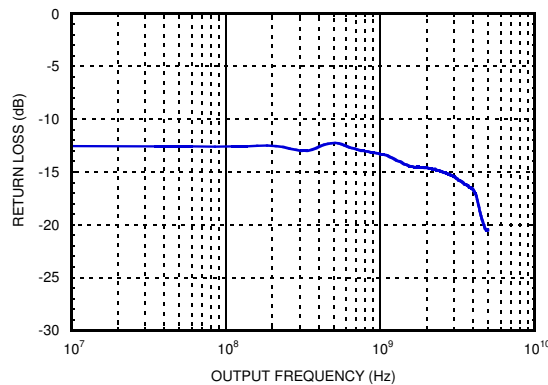
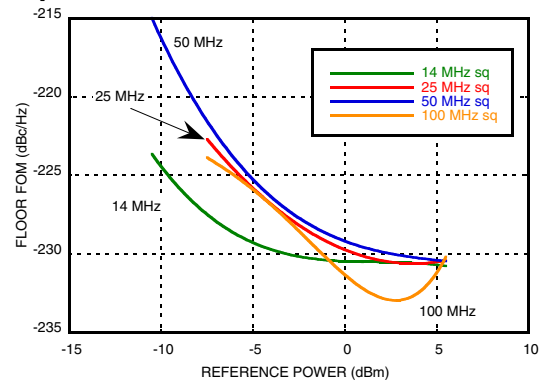

Figure 12. Reference Input Sensitivity, Square Wave, 50 Ω [2]



[1] RMS Jitter data is measured in fractional mode with 250 kHz Loop bandwidth using 100 MHz reference, PD 50 MHz. Integration bandwidth from 1 kHz to 100 MHz.

[2] Measured from a 50 Ω source with a 100 Ω external resistor termination. See [PLL with Integrated RF VCOs Operating Guide](#) Reference Input Stage section for more details. Full FOM performance up to maximum 3.3 Vpp input voltage.



**FRACTIONAL-N PLL WITH INTEGRATED VCO
45 - 1050, 1400 - 2100, 2800 - 4200 MHz**

**Figure 13. Reference Input Sensitivity
Sinusoid Wave, 50 Ω^[3]**

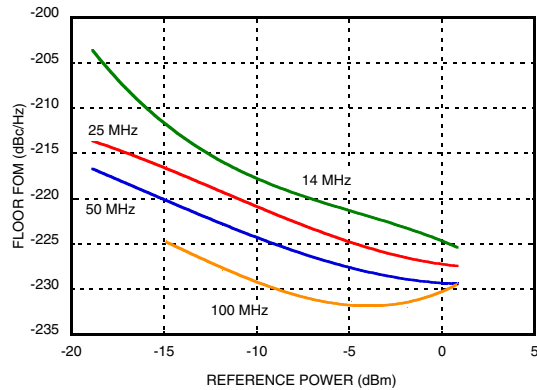

**Figure 14. Integer Boundary Spur at
3600.2 MHz^[4]**

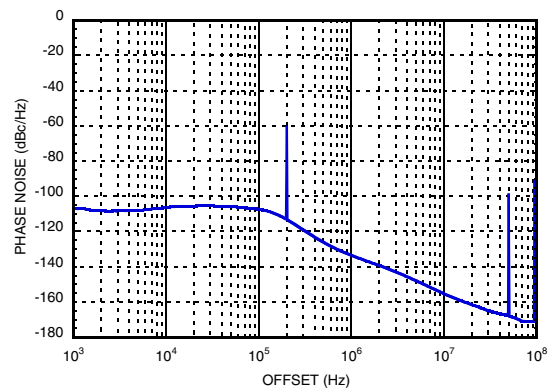

**Figure 15. Integer-N, Exact Frequency
Mode ON, Performance at 900 MHz^[5]**

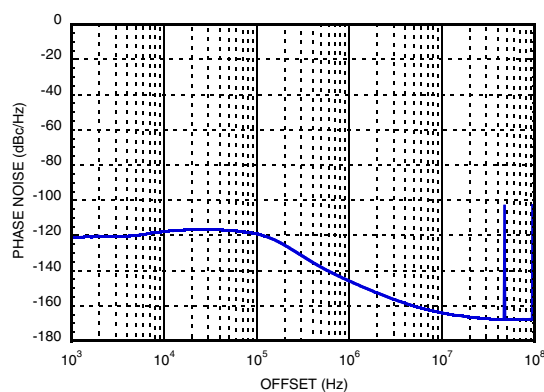

**Figure 16. Fractional-N, Exact Frequency
Mode ON, Performance at 1813.5 MHz^[6]**

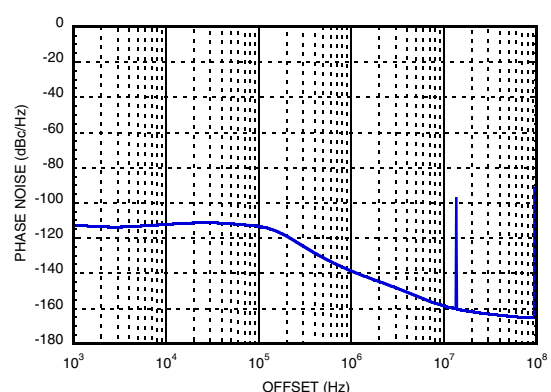

**Figure 17. Fractional-N, Exact Frequency
Mode ON, Performance at 3591 MHz^[7]**

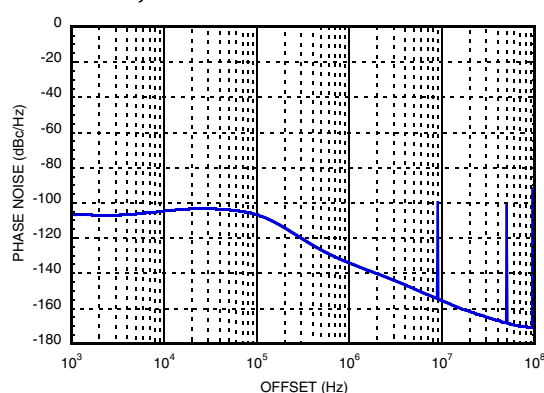

**Figure 18. Fractional-N, Exact Frequency
Mode OFF, Performance at 3591 MHz^[8]**

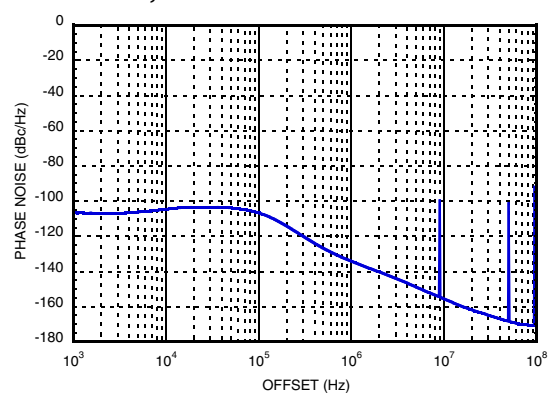

[3] Measured from a 50 Ω source with a 100 Ω external resistor termination. See [PLL with Integrated RF VCOs Operating Guide](#) Reference Input Stage section for more details. Full FOM performance up to maximum 3.3 Vpp input voltage.

[4] Fractional Mode Mode B, Integer Boundary Spur at 3600.2 MHz, Loop Filter bandwidth 130 kHz, REF in 100 MHz, 50 MHz PD

[5] REF in 100 MHz, 50 MHz PD, Output Divider 4 Selected, Loop Filter bandwidth 130 kHz, Channel Spacing 100 kHz

[6] Exact Frequency Mode, REF in 100 MHz, 50 MHz PD, Output Divider 2 Selected, Loop Filter bandwidth = 130 kHz, Channel Spacing = 100 kHz

[7] Exact Frequency Mode, Channel Spacing 100 kHz, RF out = 3951 MHz, REF in 100 MHz, 50 MHz PD, Output Divider 1 selected, Loop Filter bandwidth 130 kHz,

[8] Fractional Mode B, RF out 3591 MHz, REF in 100 MHz, 50 MHz PD, Output Divider 1 selected, Loop Filter bandwidth 130 kHz.

**FRACTIONAL-N PLL WITH INTEGRATED VCO
45 - 1050, 1400 - 2100, 2800 - 4200 MHz**



Figure 19. Worst Spur, Fixed 50 MHz Reference, Output Freq. = 3900.1 MHz^[9]

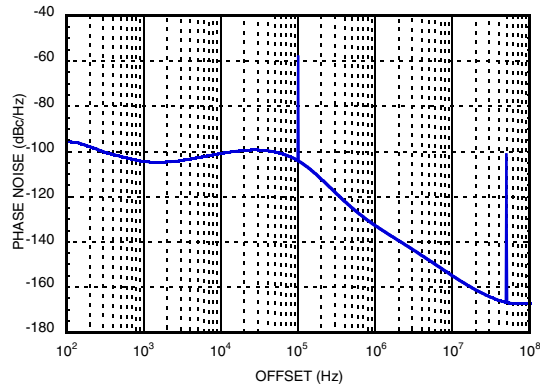

Figure 20. Worst Spur, Tunable Reference 47.5 MHz, Output Frequency = 3900.1 MHz^[9]

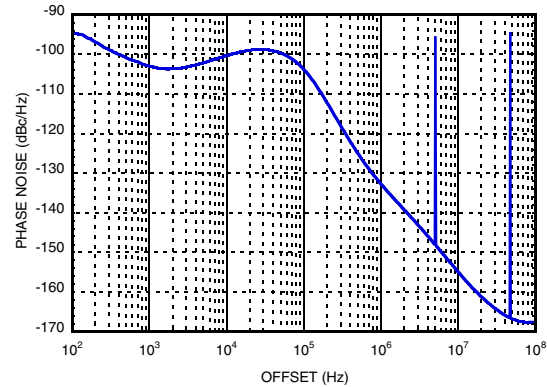

Figure 21. Worst Spur, Fixed vs. Tunable Reference^[10]

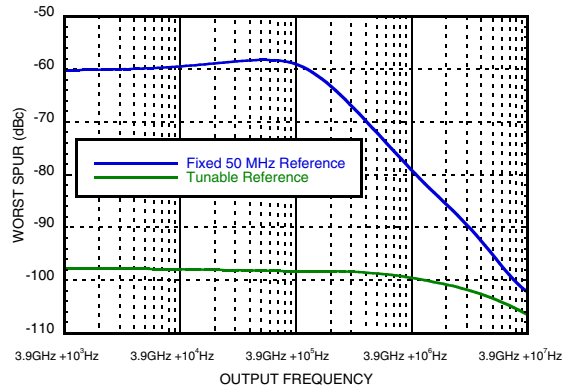
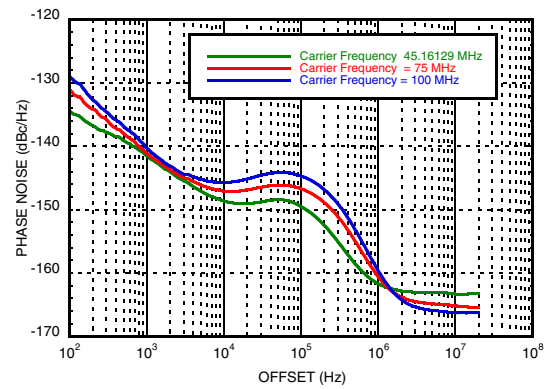

Figure 22. Low Frequency Performance^[11]



Loop Filter Configuration Table

| Loop Filter BW (kHz) | C1 (pF) | C2 (nF) | C3 (pF) | C4 (pF) | R2 (kΩ) | R3 (kΩ) | R4 (kΩ) | Loop Filter Design |
|----------------------|---------|---------|---------|---------|---------|---------|---------|--------------------|
| 130 | 100 | 8.2 | 120 | 120 | 1 | 1.2 | 1.2 | |
| 250 | 150 | 3.3 | 18 | 18 | 2.2 | 1 | 1 | |

[9] Capability of to generate low frequencies (as low as 45 MHz), enables the to be used as a tunable reference source into another Hittite PLL. This maximizes spur performance of Hittite PLLs. Please see "Application Information" for more information.

[10] The graph is generated by observing, and plotting, the magnitude of only the worst spur (largest magnitude), at any offset, at each output frequency, while using a fixed 50 MHz reference and a tunable reference tuned to 47.5 MHz. See "Application Information" for more details.

[11] Phase noise performance of the when used as a tunable reference source. is operating at 4.2 GHz/42, 4.2 GHz/56, and 2.8 GHz/62 for the 100 MHz, 75 MHz, and 45.16129 MHz curves respectively, using a second order loop filter with 230 kHz bandwidth.



**FRACTIONAL-N PLL WITH INTEGRATED VCO
45 - 1050, 1400 - 2100, 2800 - 4200 MHz**
Pin Descriptions

| Pin Number | Function | Description |
|---|----------|--|
| 1 | AVDD | DC Power Supply for analog circuitry. |
| 2, 5, 6, 8, 9, 11 - 14, 18 - 22, 24, 26, 34, 37, 38 | N/C | The pins are not connected internally; however, all data shown herein was measured with these pins connected to RF/DC ground externally. |
| 3 | VPPCP | Power Supply for charge pump analog section |
| 4 | CP | Charge Pump Output |
| 7 | VDDL5 | Power Supply for the charge pump digital section |
| 10 | RVDD | Reference Supply |
| 15 | XREFP | Reference Oscillator Input |
| 16 | DVDD3V | DC Power Supply for Digital (CMOS) Circuitry |
| 17 | CEN | Chip Enable. Connect to logic high for normal operation. |
| 23 | VTUNE | VCO Varactor. Tuning Port Input. |
| 25 | VCC2 | VCO Analog Supply 2 |
| 27 | VCC1 | VCO Analog Supply 1 |
| 28 | RF_N | RF Negative Output (On in differential and single-ended configuration) |
| 29 | RF_P | RF Positive Output (Off in single-ended, On in differential configuration) |
| 30 | SEN | PLL Serial Port Enable (CMOS) Logic Input |
| 31 | SDI | PLL Serial Port Data (CMOS) Logic Input |
| 32 | SCK | PLL Serial Port Clock (CMOS) Logic Input |
| 33 | LD_SDO | Lock Detect, or Serial Data, or General Purpose (CMOS) Logic Output (GPO) |
| 35 | VCCHF | DC Power Supply for Analog Circuitry |
| 36 | VCCPS | DC Power Supply for Analog Prescaler |
| 39 | VCCPD | DC Power Supply for Phase Detector |
| 40 | BIAS | External bypass decoupling for precision bias circuits. Note: 1.920V \pm 20mV reference voltage (BIAS) is generated internally and cannot drive an external load. Must be measured with 10G Ω meter such as Agilent 34410A, normal 10M Ω DVM will read erroneously. |

FRACTIONAL-N PLL WITH INTEGRATED VCO
45 - 1050, 1400 - 2100, 2800 - 4200 MHz
Absolute Maximum Ratings

| | |
|--|----------------|
| AVDD, RVDD, DVDD3V, VCCPD, VCCHF, VCCPS | -0.3V to +3.6V |
| VPPCP, VDDL5, VCC1, VCC2 | -0.3V to +5.5V |
| Operating Temperature | -40°C to +85°C |
| Storage Temperature | -65°C to 150°C |
| Maximum Junction Temperature | 125 °C |
| Thermal Resistance (R _{TH}) (junction to ground paddle) | 20 °C/W |
| Reflow Soldering | |
| Peak Temperature | 260°C |
| Time at Peak Temperature | 40 sec |
| ESD Sensitivity (HBM) | Class 1B |

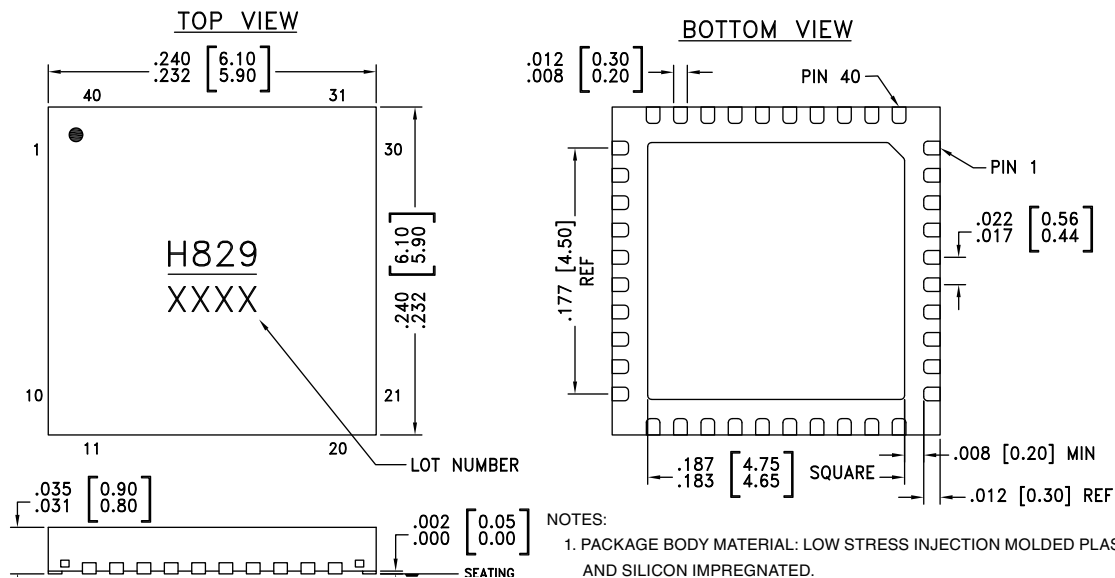
Stresses above those listed under Absolute Maximum Ratings may cause permanent damage to the device. This is a stress rating only; functional operation of the device at these or any other conditions above those indicated in the operational section of this specification is not implied. Exposure to absolute maximum rating conditions for extended periods may affect device reliability.

Outline Drawing

NOTES:

1. PACKAGE BODY MATERIAL: LOW STRESS INJECTION MOLDED PLASTIC SILICA AND SILICON IMPREGNATED.
2. LEAD AND GROUND PADDLE MATERIAL: COPPER ALLOY.
3. LEAD AND GROUND PADDLE PLATING: 100% MATTE TIN.
4. DIMENSIONS ARE IN INCHES [MILLIMETERS].
5. LEAD SPACING TOLERANCE IS NON-CUMULATIVE.
6. PAD BURR LENGTH SHALL BE 0.15mm MAX. PAD BURR HEIGHT SHALL BE 0.25mm MAX.
7. PACKAGE WARP SHALL NOT EXCEED 0.05mm.
8. ALL GROUND LEADS AND GROUND PADDLE MUST BE SOLDERED TO PCB REF GROUND.
9. REFER TO HITTITE APPLICATION NOTE FOR SUGGESTED PCB LAND PATTERN.

Package Information

| Part Number | Package Body Material | Lead Finish | MSL Rating | Package Marking ^[1] |
|-------------|--|---------------|------------|--------------------------------|
| | RoHS-compliant Low Stress Injection Molded Plastic | 100% matte Sn | MSL1 | H829 XXXX |

[1] 4-Digit lot number XXXX

FRACTIONAL-N PLL WITH INTEGRATED VCO
45 - 1050, 1400 - 2100, 2800 - 4200 MHz



Evaluation PCB

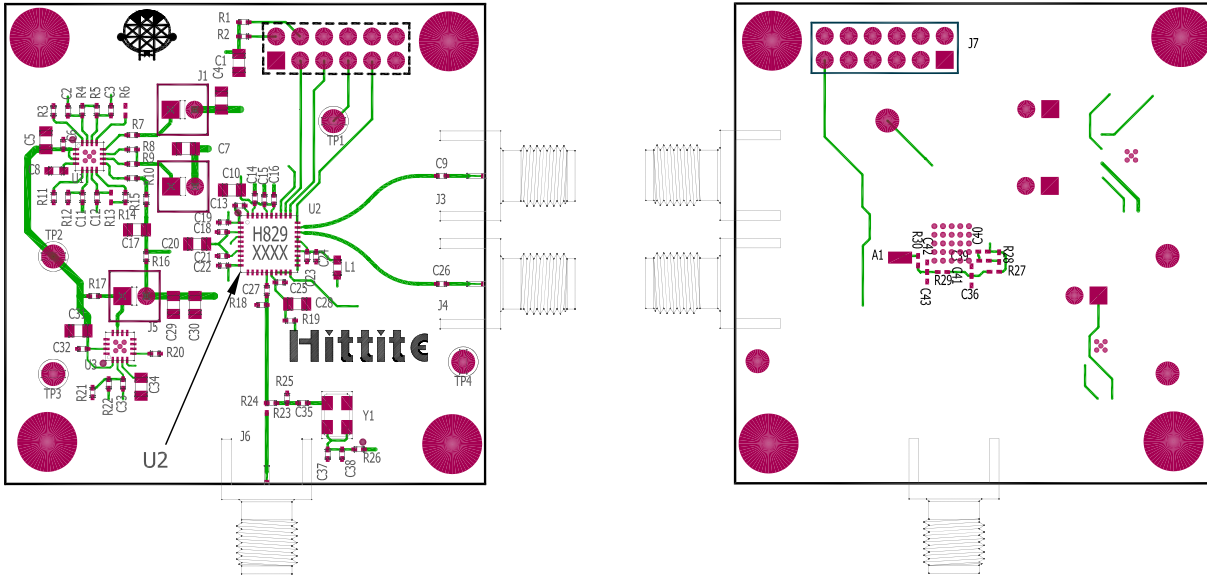

The circuit board used in the application should use RF circuit design techniques. Signal lines should have 50 Ohm impedance while the package ground leads and exposed paddle should be connected directly to the ground plane similar to that shown. A sufficient number of via holes should be used to connect the top and bottom ground planes. The evaluation circuit board shown is available from Hittite upon request.

Evaluation PCB Schematic

To view this [Evaluation PCB Schematic](http://www.hittite.com) please visit www.hittite.com and choose from the "Search by Part Number" pull down menu to view the product splash page.

Evaluation Order Information

| Item | Contents | Part Number |
|---------------------|---|-------------|
| Evaluation PCB Only | Evaluation PCB | EVAL01- |
| Evaluation Kit | Evaluation PCB USB Interface Board 6' USB A Male to USB B Female Cable CD ROM (Contains User Manual, Evaluation PCB Schematic, Evaluation Software, Hittite PLL Design Software) | EKIT01- |



FRACTIONAL-N PLL WITH INTEGRATED VCO
45 - 1050, 1400 - 2100, 2800 - 4200 MHz

Application Information

Large bandwidth, industry leading phase noise and spurious performance, excellent noise floor (<-170 dBc/Hz), coupled with a high level of integration make the ideal for a variety of applications; as an RF or IF stage LO, a clock source for high-frequency data-converters, or a tunable reference source for extremely low spurious applications (~-100 dBc/Hz spurs).

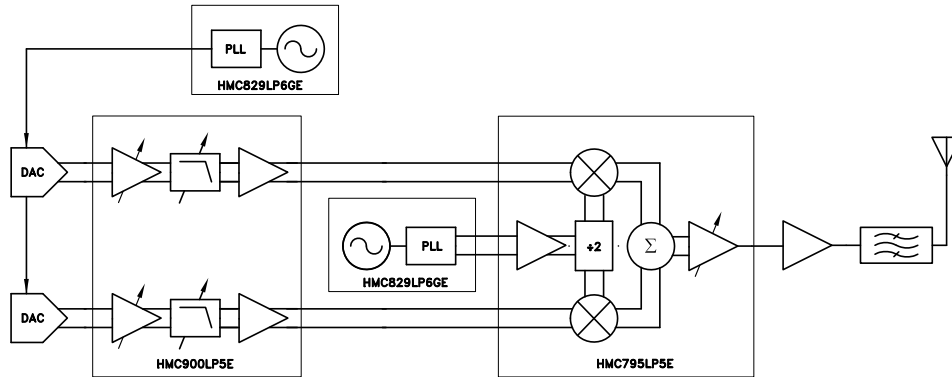

Figure 23. in a typical transmit chain

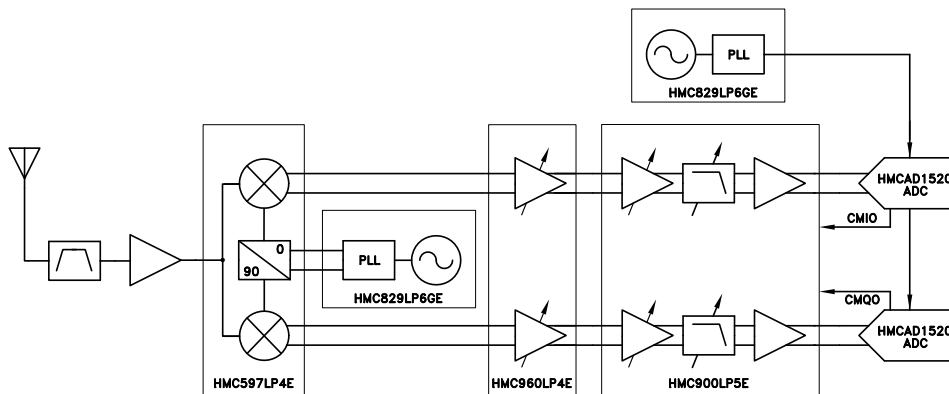

Figure 24. in a typical receive chain

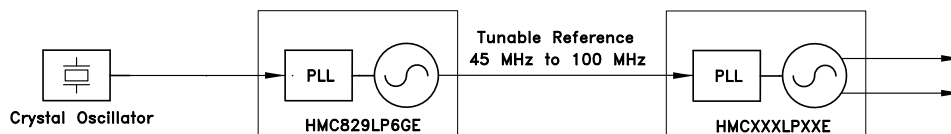

Figure 25. used as a tunable reference for second

Using the with a tunable reference as shown in [Figure 25](#), it is possible to drastically improve spurious emissions performance across all frequencies. Example shown in [Figure 21](#) graph shows that it is possible to have spurious emissions ~ -100 dBc/Hz across all frequencies. For more information about spurious emissions, how they are related to the reference frequency, and how to tune the reference frequency for optimal spurious performance please see the “Spurious Performance” section of [Hittite PLL w/ Integrated VCOs Operating Guide](#). Note that at very low output frequencies < 100 MHz, harmonics increase due to small internal AC coupling. Applications which are sensitive to harmonics may require external low pass filtering.

Information furnished by Analog Devices is believed to be accurate and reliable. However, no responsibility is assumed by Analog Devices for its use, nor for any infringements of patents or other rights of third parties that may result from its use. Specifications subject to change without notice. No license is granted by implication or otherwise under any patent or patent rights of Analog Devices. Trademarks and registered trademarks are the property of their respective owners.

For price, delivery, and to place orders: Analog Devices, Inc., One Technology Way, P.O. Box 9106, Norwood, MA 02062-9106 Phone: 781-329-4700 • Order online at www.analog.com Application Support: Phone: 1-800-ANALOG-D

Mouser Electronics

Authorized Distributor

Click to View Pricing, Inventory, Delivery & Lifecycle Information:

[Analog Devices Inc.:](#)

[HMC829LP6GE](#) [EKIT01-HMC829LP6GE](#) [HMC829LP6GETR](#) [EVAL01-HMC829LP6GE](#)