

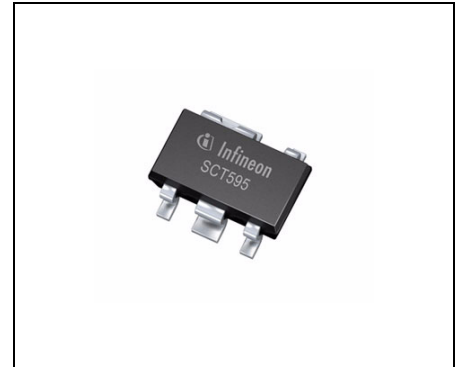

Features

- Three versions: 3.0 V, 3.3 V, 5.0 V
- Output voltage tolerance $\leq \pm 4\%$
- Very low drop voltage
- Output current: 30 mA
- Inhibit input
- Low quiescent current consumption
- Wide operation range: up to 45 V
- Wide temperature range: $-40\text{ }^{\circ}\text{C} \leq T_j \leq 150\text{ }^{\circ}\text{C}$
- Output protected against short circuit
- Overtemperature protection
- Reverse polarity proof
- Very small SMD-Package PG-SCT595-5
- Green product (RoHS compliant)
- AEC qualified



PG-SCT595-5

Functional Description

The **TLE 4296 G** is a monolithic integrated low drop voltage regulator in the very small SMD package PG-SCT595-5. It is designed to supply e.g. microprocessor systems under the severe conditions of automotive applications. Therefore the device is equipped with additional protection functions against overload, short circuit and reverse polarity. At overtemperature the regulator is automatically turned off by the integrated thermal protection circuit.

Input voltages up to 40 V are regulated to $V_{Q,nom} = 3.0\text{ V}$ (V30 version) 3.3 V (V33 version) or 5.0 V (V50 version). The output is able to drive a load of more than 30 mA while it regulates the output voltage within a 4% accuracy.

To save energy the device can be switched in stand-by mode via an inhibit input which causes the current consumption to drop below 5 μA .

Type	Package	Marking
TLE 4296 GV30	PG-SCT595-5	C3
TLE 4296 GV33	PG-SCT595-5	C2
TLE 4296 GV50	PG-SCT595-5	C1

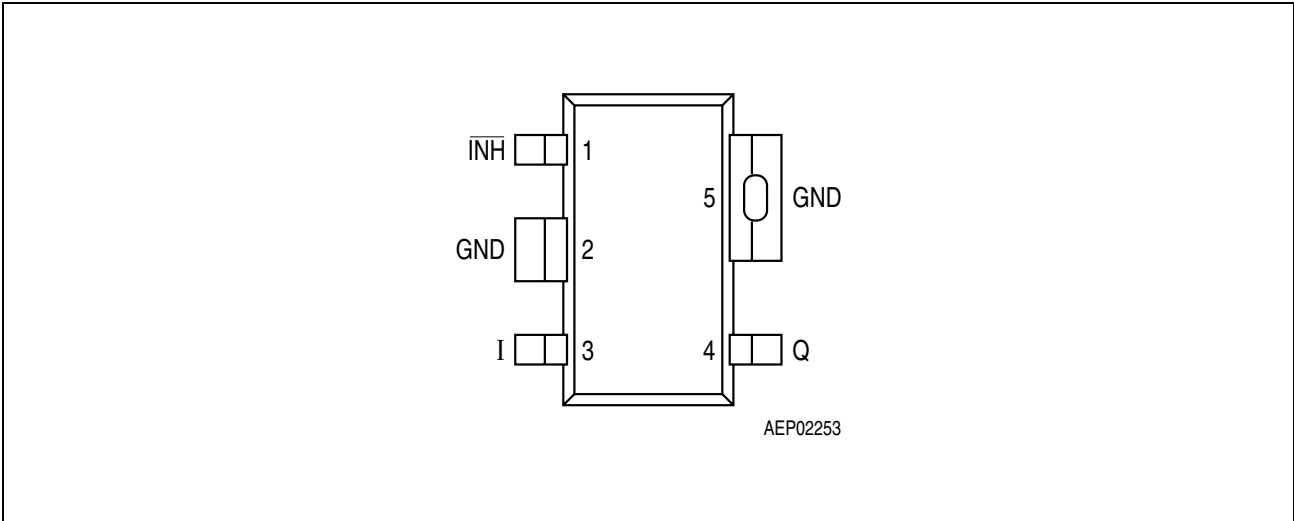

Figure 1 Pin Configuration (top view)

Table 1 Pin Definitions and Functions

Pin No.	Symbol	Function
1	$\overline{\text{INH}}$	Inhibit input ; high level to turn IC on
2	GND	Ground ; connected to pin 5
3	I	Input voltage
4	Q	Output voltage ; must be blocked by a capacitor $C_Q \geq 2.2 \mu\text{F}$, $3 \Omega \leq \text{ESR} \leq 10 \Omega$
5	GND	Ground ; connected to pin 2

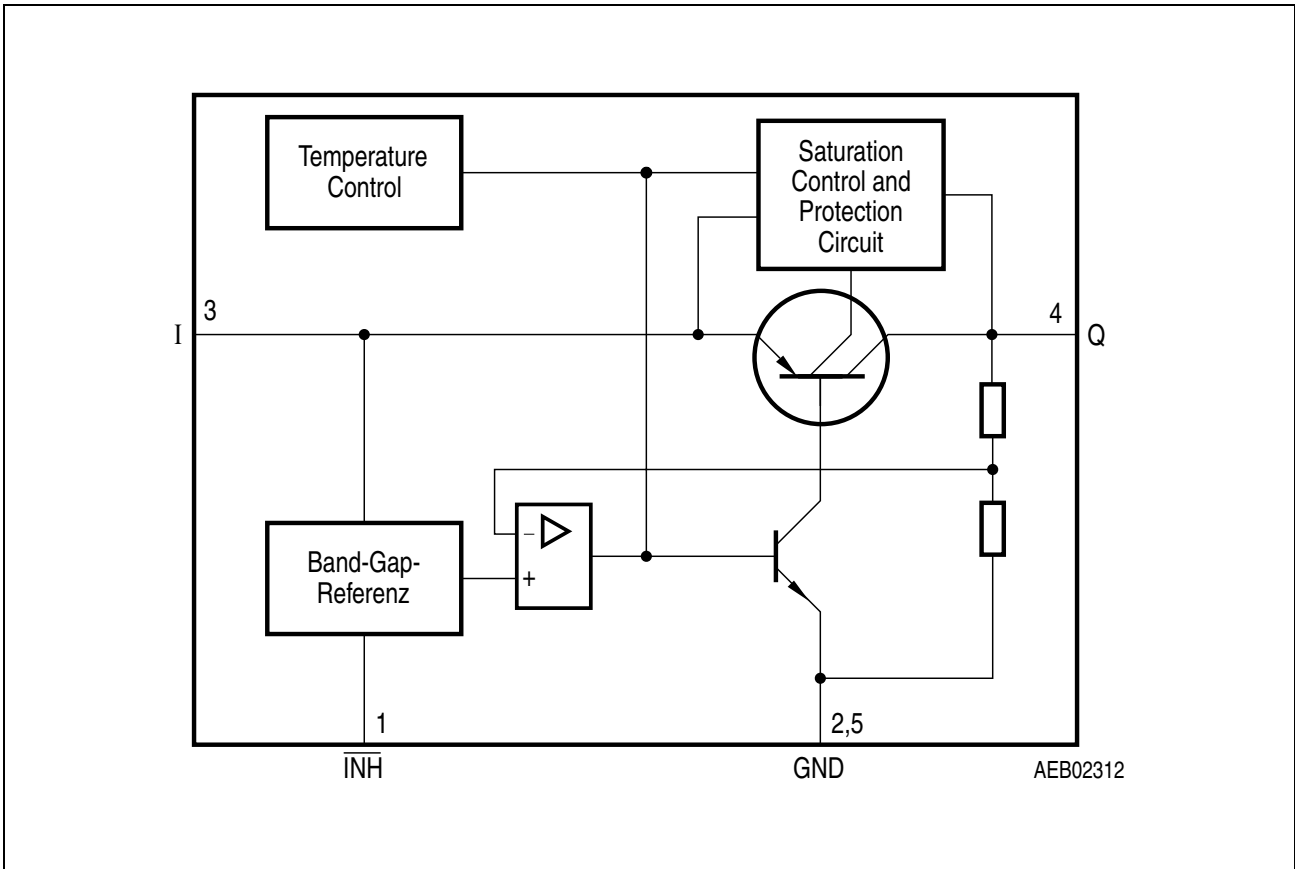

Figure 2 **Block Diagram**

Table 2 Absolute Maximum Ratings
 $-40\text{ °C} < T_j < 150\text{ °C}$

Parameter	Symbol	Limit Values		Unit	Remarks
		Min.	Max.		
Input					
Voltage	V_I	-42	45	V	–
Current	I_I	–	–	mA	internally limited
Output					
Voltage	V_Q	-6	30	V	–
Current	I_Q	–	–	mA	internally limited
Inhibit					
Voltage	V_{INH}	-42	45	V	–
Current	I_{INH}	-500	*	μA	* internally limited
Current	I_{INH}	-5	5	mA	$-0.3\text{ V} < V_I < 45\text{ V};$ $t_p < 1\text{ ms}$
Temperatures					
Junction temperature	T_j	-40	150	$^{\circ}\text{C}$	–
Storage temperature	T_{stg}	-50	150	$^{\circ}\text{C}$	–
Thermal Resistances					
Junction pin	$R_{thj-pin}$	–	30	K/W	measured to pin 5
Junction ambient ¹⁾	R_{thja}	–	179	K/W	zero airflow zero heat sink area

1) Worst case regarding peak temperature.

Note: Maximum ratings are absolute ratings; exceeding any one of these values may cause irreversible damage to the integrated circuit.

Table 3 Operating Range

Parameter	Symbol	Limit Values		Unit	Remarks
		Min.	Max.		
Input voltage	V_I	4.0	45	V	TLE 4296 GV30
		4.0	45	V	TLE 4296 GV33
		5.5	45	V	TLE 4296 GV50
Inhibit voltage	V_{INH}	-0.3	40	V	–
Junction temperature	T_j	-40	150	°C	–

Table 4 Electrical Characteristics
 $V_I = 13.5 \text{ V}; V_{\text{INH}} > +2.5 \text{ V}; -40 \text{ }^\circ\text{C} < T_j < 150 \text{ }^\circ\text{C};$ unless otherwise specified

Parameter	Symbol	Limit Values			Unit	Test Condition
		Min.	Typ.	Max.		
Output voltage V30 version	V_Q	2.88	3.0	3.12	V	$1 \text{ mA} < I_Q < 30 \text{ mA}$ $V_I = 13.5 \text{ V}$
Output voltage V30 version	V_Q	2.88	3.0	3.12	V	$I_Q = 10 \text{ mA}$ $4 \text{ V} < V_I < 40 \text{ V}$
Output voltage V33 version	V_Q	3.17	3.30	3.43	V	$1 \text{ mA} < I_Q < 30 \text{ mA}$ $V_I = 13.5 \text{ V}$
Output voltage V33 version	V_Q	3.17	3.30	3.43	V	$I_Q = 10 \text{ mA}$ $4.3 \text{ V} < V_I < 40 \text{ V}$
Output voltage V50 version	V_Q	4.80	5.00	5.20	V	$1 \text{ mA} < I_Q < 30 \text{ mA}$ $V_I = 13.5 \text{ V}$
Output voltage V50 version	V_Q	4.80	5.00	5.20	V	$I_Q = 10 \text{ mA}$ $6 \text{ V} < V_I < 40 \text{ V}$
Output current limitation	I_Q	30	–	–	mA	¹⁾
Drop voltage	V_{dr}	–	0.25	0.30	V	$I_Q = 20 \text{ mA}^{\text{1)}$
Output capacitor	C_Q	2.2	–	–	μF	$3 \Omega \leq \text{ESR} \leq 10 \Omega$ at 100 kHz
Current consumption $I_q = I_l - I_Q$	I_q	–	2	4.5	mA	$I_Q < 30 \text{ mA}$
Current consumption $I_q = I_l - I_Q$	I_q	–	110	170	μA	$I_Q < 1 \text{ mA};$ $T_j < 85 \text{ }^\circ\text{C}$
Quiescent current (stand-by) $I_q = I_l - I_Q$	I_q	–	0	1	μA	$V_{\text{INH}} = 0.4 \text{ V};$ $T_j < 85 \text{ }^\circ\text{C}$
Quiescent current (stand-by) $I_q = I_l - I_Q$	I_q	–	0	5	μA	$V_{\text{INH}} = 0.4 \text{ V}$
Load regulation	ΔV_Q	–	10	20	mV	$1 \text{ mA} < I_Q < 25 \text{ mA};$ $T_j = 25 \text{ }^\circ\text{C}$
Line regulation	ΔV_Q	–	5	20	mV	$V_I = (V_{Q,\text{nom}} + 0.5 \text{ V})$ to 36 V $I_Q = 5 \text{ mA}; T_j = 25 \text{ }^\circ\text{C}$

Table 4 Electrical Characteristics (cont'd)
 $V_I = 13.5 \text{ V}; V_{\overline{\text{INH}}} > +2.5 \text{ V}; -40 \text{ }^\circ\text{C} < T_j < 150 \text{ }^\circ\text{C};$ unless otherwise specified

Parameter	Symbol	Limit Values			Unit	Test Condition
		Min.	Typ.	Max.		
Power-Supply-Ripple-Rejection	$PSRR$	–	60	–	dB	$f_r = 100 \text{ Hz};$ $V_r = 0.5 \text{ Vpp}$

Logic Inhibit Input

Inhibit, Turn-on voltage	$V_{\overline{\text{INH}}, \text{high}}$	–	–	2.2	V	$V_Q > 0.95 V_{Q, \text{nom}}$
Inhibit, Turn-off voltage	$V_{\overline{\text{INH}}, \text{low}}$	0.4	–	–	V	$V_Q > 0.1 \text{ V}$
H-input current	$I_{\overline{\text{INH}}, \text{high}}$	–	8	12	μA	$V_{\overline{\text{INH}}} = 5 \text{ V}$
L-input current	$I_{\overline{\text{INH}}, \text{low}}$	-2	–	2	μA	$V_{\overline{\text{INH}}} = 0 \text{ V}$

 1) Measured when the output voltage V_Q has dropped 100 mV from the nominal value.

Typical Performance Characteristics

Output Voltage V_Q versus Input Voltage V_I

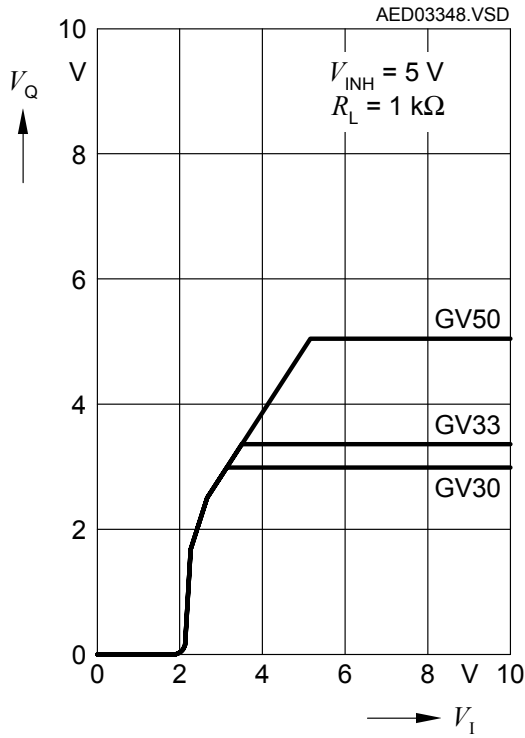

Current Consumption I_q versus Input Voltage V_I

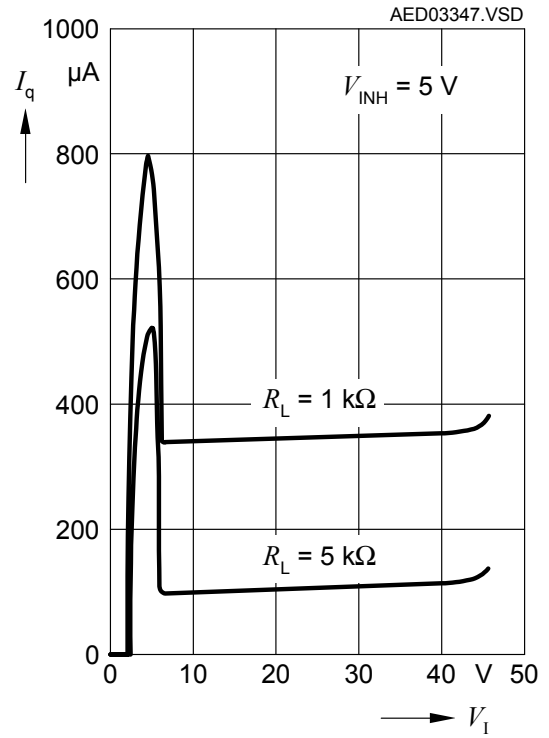

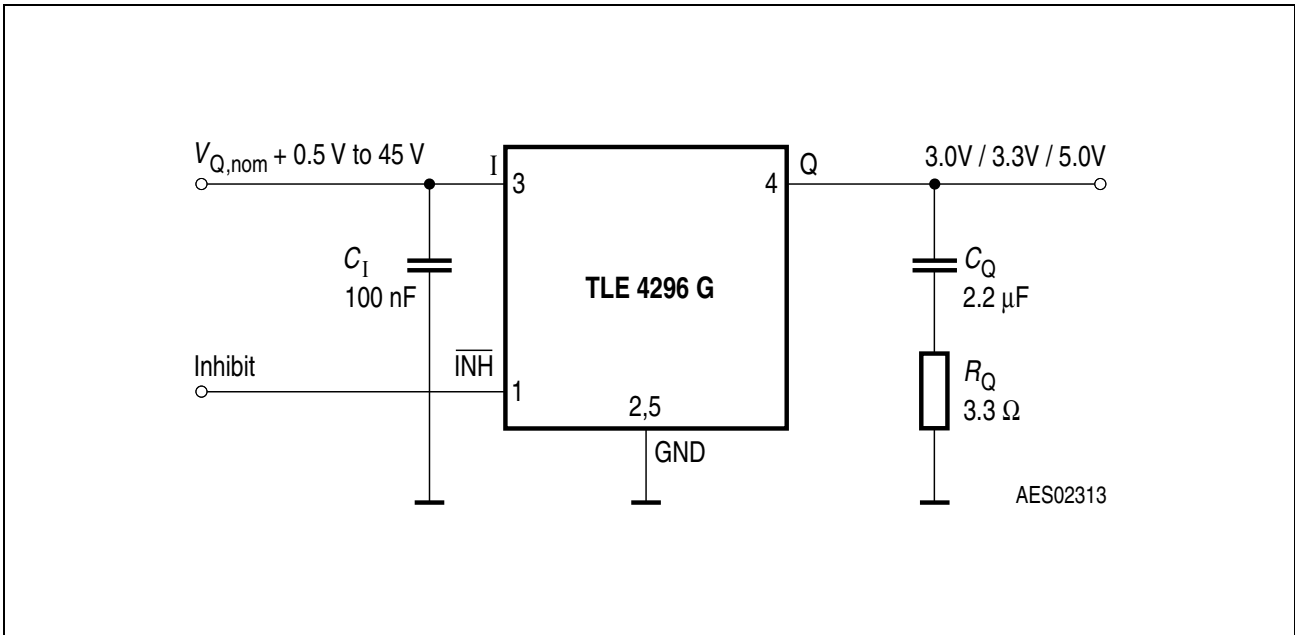

Figure 3 Application Circuit

Application Information

In the TLE 4296 G the output voltage is divided and compared to an internal reference of 2.5 V typical. The regulation loop controls the output to achieve a stabilized output voltage.

Figure 3 shows a typical application circuit. In order to maintain the stability of the control loop the TLE 4296 G output requires an output capacitor C_Q of at least 2.2 μF with an ESR of max. 10 Ω and min. 3 Ω . It is recommended to use tantalum (e.g. the EPCOS 3.3 μF / 16V B45196P3335M209 or 4.7 μF / 10 V B45196-P2475M109) or a multi layer ceramic capacitor with a series resistor in order to cover these limits over the full operating temperature range of -40 $^\circ\text{C}$ to 150 $^\circ\text{C}$.

At the input of the regulator an input capacitor is necessary for compensating line influences (100 nF ceramic capacitor recommended). A resistor of approx. 1 Ω in series with C_1 , can damp any oscillation occurring due the input inductivity and the input capacitor.

Package Outlines

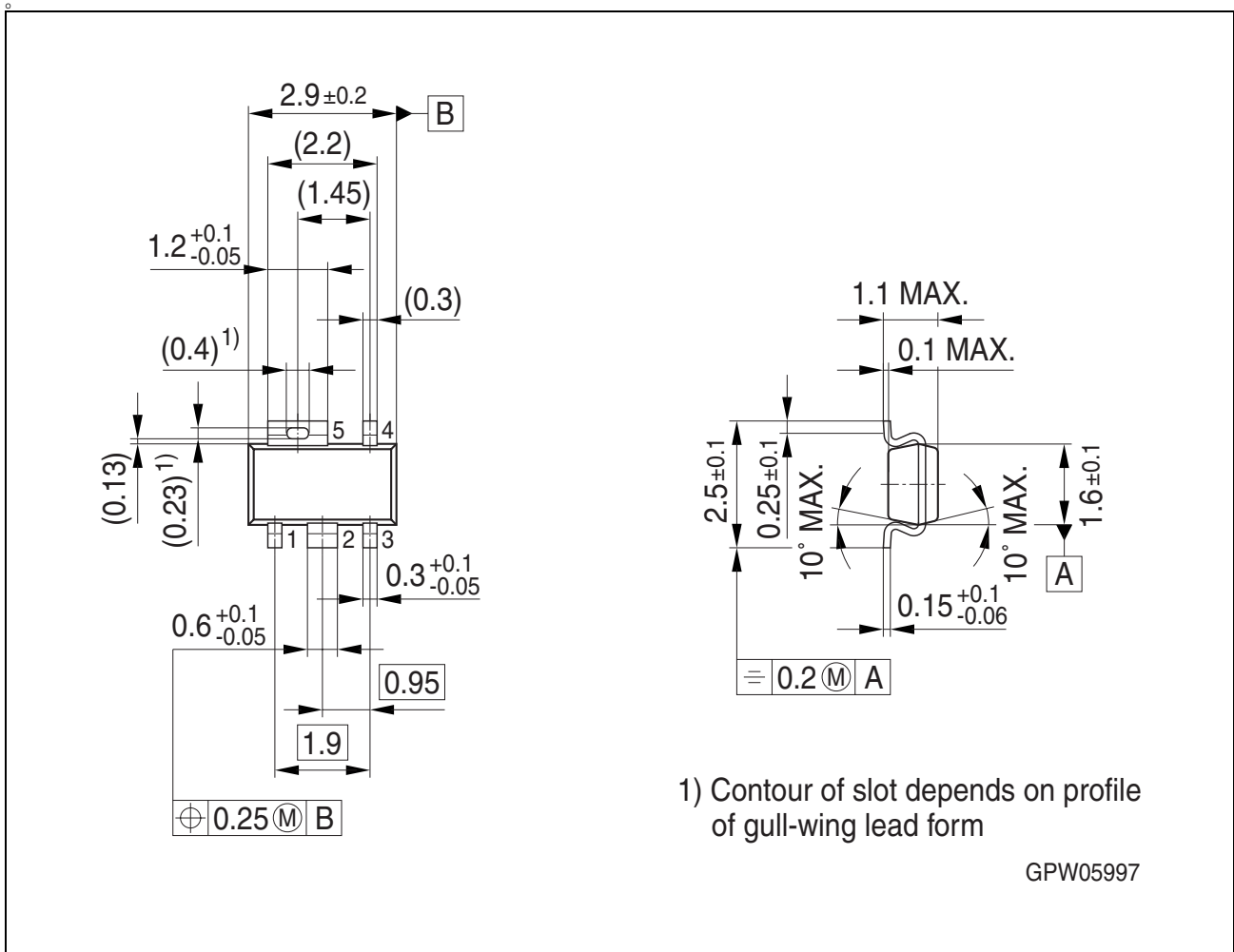

Figure 4 Outline PG-SCT595-5

Green Product (RoHS compliant)

To meet the world-wide customer requirements for environmentally friendly products and to be compliant with government regulations the device is available as a green product. Green products are RoHS-Compliant (i.e Pb-free finish on leads and suitable for Pb-free soldering according to IPC/JEDEC J-STD-020).

You can find all of our packages, sorts of packing and others in our Infineon Internet Page "Products": <http://www.infineon.com/packages>.

SMD = Surface Mounted Device

Dimensions in mm

Revision History

Version	Date	Changes
Rev. 1.1	2008-04-21	Initial version of RoHS-compliant derivate of TLE 4296. Page 1 : AEC certified statement added. Page 1 and Page 10 : RoHS compliance statement and Green product feature added. Page 1 and Page 10 : Package changed to RoHS compliant version. Page 1 : Marking information added. Legal Disclaimer updated
Rev. 1.0	2004-01-01	Final datasheet

Edition 2008-04-21

**Published by
Infineon Technologies AG
81726 Munich, Germany**

**© 2008 Infineon Technologies AG
All Rights Reserved.**

Legal Disclaimer

The information given in this document shall in no event be regarded as a guarantee of conditions or characteristics. With respect to any examples or hints given herein, any typical values stated herein and/or any information regarding the application of the device, Infineon Technologies hereby disclaims any and all warranties and liabilities of any kind, including without limitation, warranties of non-infringement of intellectual property rights of any third party.

Information

For further information on technology, delivery terms and conditions and prices, please contact the nearest Infineon Technologies Office (www.infineon.com).

Warnings

Due to technical requirements, components may contain dangerous substances. For information on the types in question, please contact the nearest Infineon Technologies Office.

Infineon Technologies components may be used in life-support devices or systems only with the express written approval of Infineon Technologies, if a failure of such components can reasonably be expected to cause the failure of that life-support device or system or to affect the safety or effectiveness of that device or system. Life support devices or systems are intended to be implanted in the human body or to support and/or maintain and sustain and/or protect human life. If they fail, it is reasonable to assume that the health of the user or other persons may be endangered.

Mouser Electronics

Authorized Distributor

Click to View Pricing, Inventory, Delivery & Lifecycle Information:

[Infineon:](#)

[TLE4296G V30](#) [TLE4296G V33](#) [TLE4296GV30NTSA1](#) [TLE4296GV33NTSA1](#) [TLE4296GV50NTSA1](#)
[TLE4296GV30HTSA1](#) [TLE4296GV33HTSA1](#)