

Type ROX Series

Key Features

- High Power with Small Size for Space Saving
- Excellent Long Term Stability
- Complete Flameproof Construction
- High Surge/Overload Capability
- Controlled Temperature Capability
- Solvent Resistant Coat and Code
- Special Lead Formations Possible



The resistive element comprises a metal oxide film deposited on a ceramic former. The element is protected by a flameproof coating which will withstand overload conditions without flame or mechanical damage. They are recommended for use in applications such as line protection etc...

Characteristics - Electrical

	ROX05	ROX1	ROX2	ROX05S	ROX1SS	ROX1S	ROX2S	ROX3S	ROX5S
Rated Power @ 70°C (W):	0.5	1	2	0.5	1	1	2	3	5
Resistance Range (ohms) Min:	0.1	0.1	0.1	0.1	0.1	0.1	0.1	0.1	0.1
Max:	330K	470K	560K	100K	200R	270K	470K	560K	560K
Tolerance and Code Letter:	2% (G) / 5% (J) 1% (F) available on request								
Temp. Coefficient Max (ppm/°C):	± 350								
Selection Series:	E24								
Limiting Element Voltage (V):	250	350	350	250	350	350	350	350	500
Maximum Overload Voltage (V):	400	600	600	400	400	600	600	600	800
Max Intermittent Overload Voltage (V):	500	750	750	500	500	750	750	750	1500
Operating Temp. Range (°C):	-55 to +155								
Climatic Category:	55/155/42								
Dielectric Strength (V):	250	350	350	250	350	350	350	350	500
Insulation Resistance (Mohms):	1,000								

Mounting

The resistors are suitable for processing on automatic insertion equipment and cutting and bending machines.

Marking

The resistors are marked with a four-band colour code in accordance with IEC 62. Grey base colour for Standard Range, Sea Blue colour for "S" Range.

Type ROX Series

Dimensions

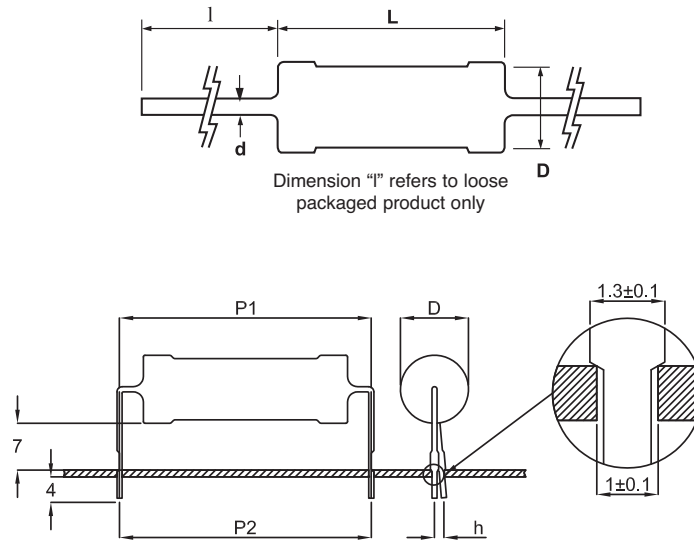

Standard Range Leded

Style	D max	L Max	l±/3	d±/0.05
ROX05	3.5	10	28	0.54
ROX1	5	12	25	0.7
ROX2	5.5	16	28	0.7

Standard Range Pre-formed

Style	P1 ±0.5	P2 ±2	H1	H2	h max
ROX05	12.5	12.5	7.5 ±1.5	3.5 ±1	2.0
ROX1	15	15	7.5 ±1.5	3.5 ±1	2.0
ROX2	20	20	7.5 ±2.0	3.5 ±1	3.0

"S" Range Leded

Style	D max	L Max	l±/3	d±/0.05
ROX05S	2.5	7.5	28	0.54
ROX1SS	2.5	7.5	28	0.54
ROX1S	3.5	10	28	0.7
ROX2S	5	12	25	0.7
ROX3S	5.5	16	28	0.7
ROX5S	8	25	38	0.75

"S" Range Pre-formed

Style	P1 ±0.5	P2 ±2	H1	H2	h max
ROX05S	10	10	7.5 ±1.5	3.5 ±1	2.0
ROX1SS	10	10	7.5 ±1.5	3.5 ±1	2.0
ROX1S	12.5	12.5	7.5 ±0.5	3.5 ±1	2.0
ROX2S	15	15	7.5 ±1.5	3.5 ±1	2.9
ROX3S	20	20	7.5 ±2.0	3.5 ±1	3.0
ROX5S	30	30	7.5 ±2.0	3.5 ±1	3.0

Power Derating Curve



Type ROX Series

Packaging



New Style Reference	Quantity per Ammo Pack	Std tape Spacing *S ±1	Component Spacing c ±0.5
ROX05	2,000	52	5
ROX1	1,000	52	5
ROX2	1,000	63	10
ROX05S	2,000	52	5
ROX1SS	2,000	52	5
ROX1S	2,000	52	5
ROX2S	1,000	52	5
ROX3S	1,000	63	10
ROX5S	500	63	10

* Other tape spacings available on request
Other packaging styles are available on request

Performance Characteristics

The evaluation of the performance characteristics is carried out with reference to IEC Specifications QC 400 000 and QC 400 100.

TEST REF	Long Term Tests ± (5% + 0.1 ohm)
4.23	Climatic sequence
4.24	Damp heat, steady state
4.25.1	Endurance at 70°C
4.25.3	Endurance at 235°C
TEST REF	Short Term Tests ± (1% + 0.05 ohm)
4.13	Overload
4.16	Robustness of terminations
4.18	Resistance to soldering heat
4.19	Rapid change of temperature
4.22	Vibration

Heat Rise Chart



How to Order

ROX	1	J	100R	BL
Common Part	Style	Tolerance	Value	Preform
ROX - Flame-Proof Power Metal Oxide Film Resistor	1 - 1S 2 - 2S 3 - 3S	G - 2% J - 5% (F - 1% available on request)	100 ohm (100 ohms) 100R 1K0 (1000 ohms) 1K0 100 K ohm (100,000 ohms) 100K	BL - Preformed Leads

TE Connectivity, TE connectivity (logo) and TE (logo) are trademarks.
Other logos, product and Company names mentioned herein may be trademarks of their respective owners.

While TE has made every reasonable effort to ensure the accuracy of the information in this datasheet, TE does not guarantee that it is error-free, nor does TE make any other representation, warranty or guarantee that the information is accurate, correct, reliable or current. TE reserves the right to make any adjustments to the information contained herein at any time without notice. TE expressly disclaims all implied warranties regarding the information contained herein, including, but not limited to, any implied warranties of merchantability or fitness for a particular purpose. The dimensions in this datasheet are for reference purposes only and are subject to change without notice. Specifications are subject to change without notice. Consult TE for the latest dimensions and design specifications.

Mouser Electronics

Authorized Distributor

Click to View Pricing, Inventory, Delivery & Lifecycle Information:

[TE Connectivity:](#)

[ROX2SJ18R](#)