

KBU25005-G Thru. KBU2510-G

Reverse Voltage: 50 to 1000V

Forward Current: 25.0A

RoHS Device

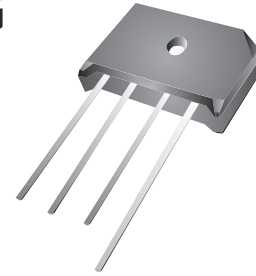

Features

- Surge overload rating -400 amperes peak.
- Ideal for printed circuit board.
- UL recognized file # E349301

Mechanical Data

- Epoxy: UL 94V-0 rate flame retardant.
- Case: Molded plastic, KBU
- Mounting position: Any.
- Weight: 7.40 grams (approx.).

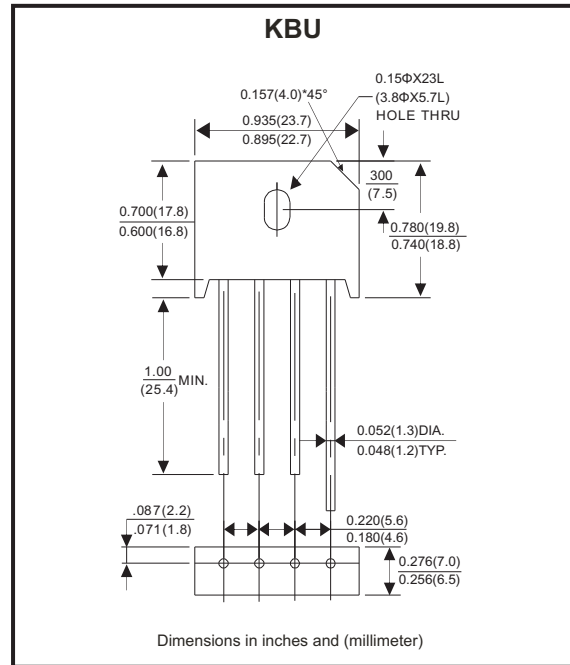

Maximum ratings and electrical characteristics

Rating at 25°C ambient temperature unless otherwise specified.
Single phase, half wave ,60Hz, resistive or inductive load.
For capacitive load, derate current by 20%

Parameter	Symbol	KBU 25005-G	KBU 2501-G	KBU 2502-G	KBU 2504-G	KBU 2506-G	KBU 2508-G	KBU 2510-G	Unit	
Maximum Recurrent Peak Reverse Voltage	V_{RRM}	50	100	200	400	600	800	1000	V	
Maximum RMS Voltage	V_{RMS}	35	70	140	280	420	560	700	V	
Maximum DC Blocking Voltage	V_{DC}	50	100	200	400	600	800	1000	V	
Max. Average Forward Rectified Current @Tc=100°C (with heatsink note 1) (without heatsink)	I_{AV}	25.0						3.6		A
Peak Forward Surge Current, 8.3ms Single Half Sine-Wave Super Imposed On Rated Load (JEDEC Method)	I_{FSM}	400								A
Maximum Forward Voltage at 12.5A DC	V_F	1.1								V
Max. DC Reverse Current at Rated DC Blocking Voltage @Tj=25°C @Tj=125°C	I_R	10.0						500		μA
Operating Temperature Range	T_J	-55 to +150								°C
Storage Temperature Range	T_{STG}	-55 to +150								°C

Notes:
1. Device mounted on 100mm*100mm*1.6mm Cu plate heatsink.

Rating and Characteristics Curves (KBU25005-G Thru. KBU2510-G)

Fig.1 - Derating Curve Output Rectified Current

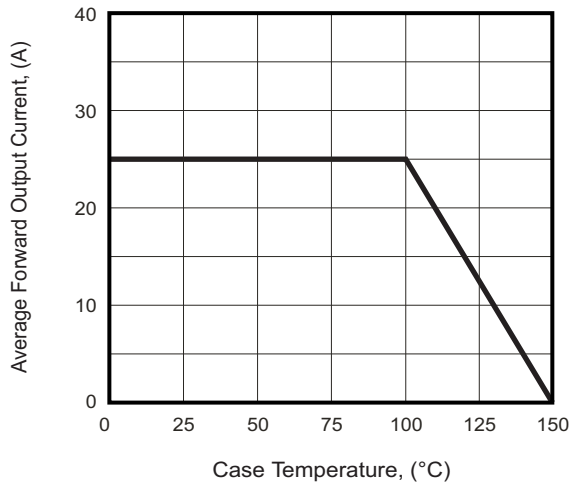

Fig.2 - Typical Forward Characteristics

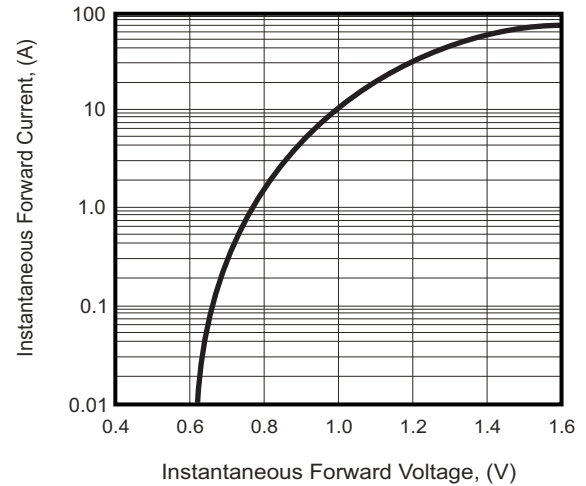

Fig.3 - Max. Forward Surge Current

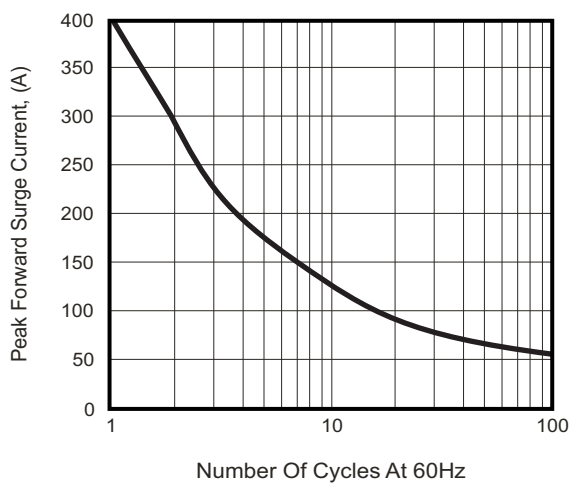
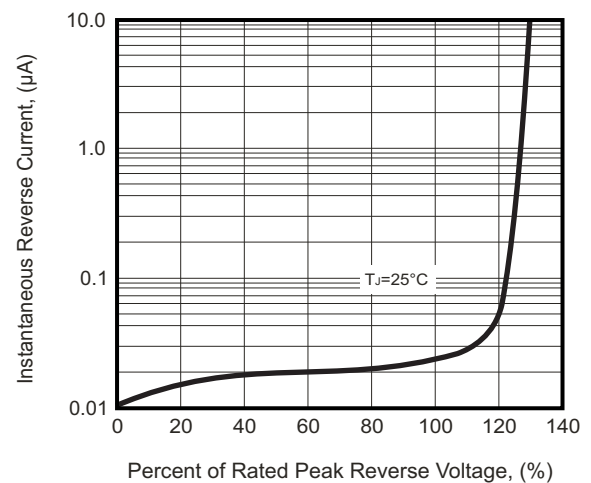
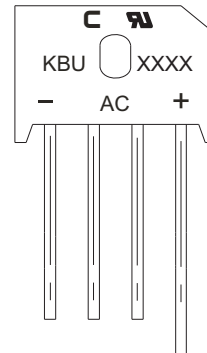

Fig.4 - Typical Reverse Characteristics



Marking Code

Part Number	Marking code
KBU25005-G	KBU25005
KBU2501-G	KBU2501
KBU2502-G	KBU2502
KBU2504-G	KBU2504
KBU2506-G	KBU2506
KBU2508-G	KBU2508
KBU2510-G	KBU2510



XXXXX / XXXX = Product type marking code

C = Compchip Logo

Standard Packaging

Case Type	BULK PACK	
	BOX (pcs)	Carton (pcs)
KBU	400	2,400

Mouser Electronics

Authorized Distributor

Click to View Pricing, Inventory, Delivery & Lifecycle Information:

[Comchip Technology:](#)

[KBU2510-G](#)