

THIS DRAWING IS UNPUBLISHED
 RELEASED FOR PUBLICATION
 20
 COPYRIGHT 20 BY - ALL RIGHTS RESERVED.

REVISIONS					
P	LTR	DESCRIPTION	DATE	DWN	APVD
	D1	REVISED PER ECO-11-005294	30APR2011	RK	HMR
	E	REVISED PER ECO-13-019231	09DEC2013	DR	RB

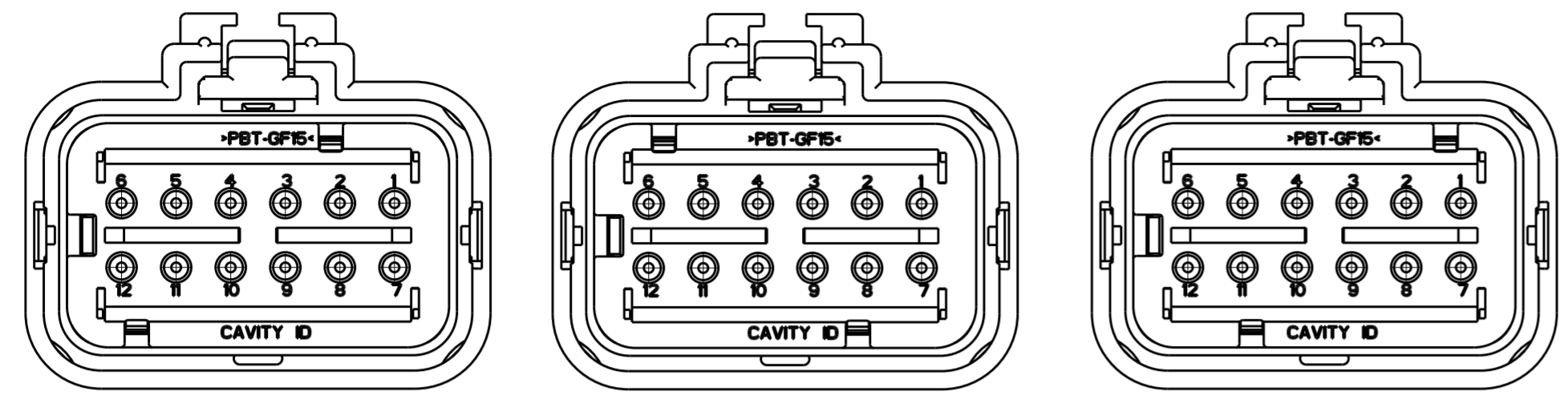

776533-2
SCALE 2:1

776533-3
SCALE 2:1

776533-4
SCALE 2:1

- 1 MATERIAL: 15% GLASS FILLED THERMOPLASTIC
COLOR: BLACK
- 2 MATERIAL: 15% GLASS FILLED THERMOPLASTIC
COLOR: (SEE TABLE)
- 3 MATERIAL: SILICONE
COLOR: RUST
- 4 MATERIAL: 15% GLASS FILLED THERMOPLASTIC
COLOR: RED
- 5. RECOMMENDED WIRE DIAMETER RANGE IS 1.30 TO 2.54mm
- 6 MATERIAL: SILICONE
COLOR: TAN

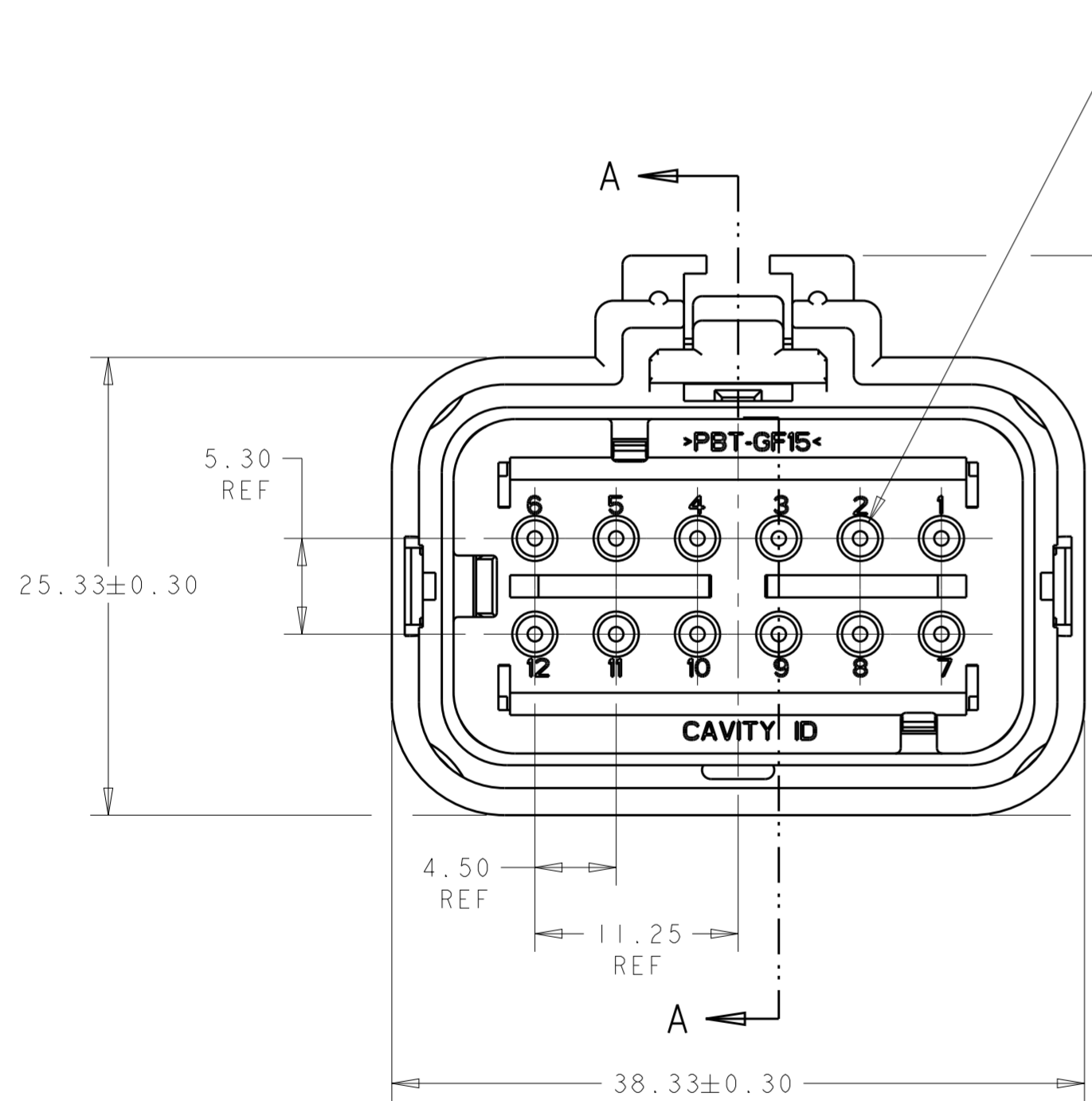

776533-1 SHOWN

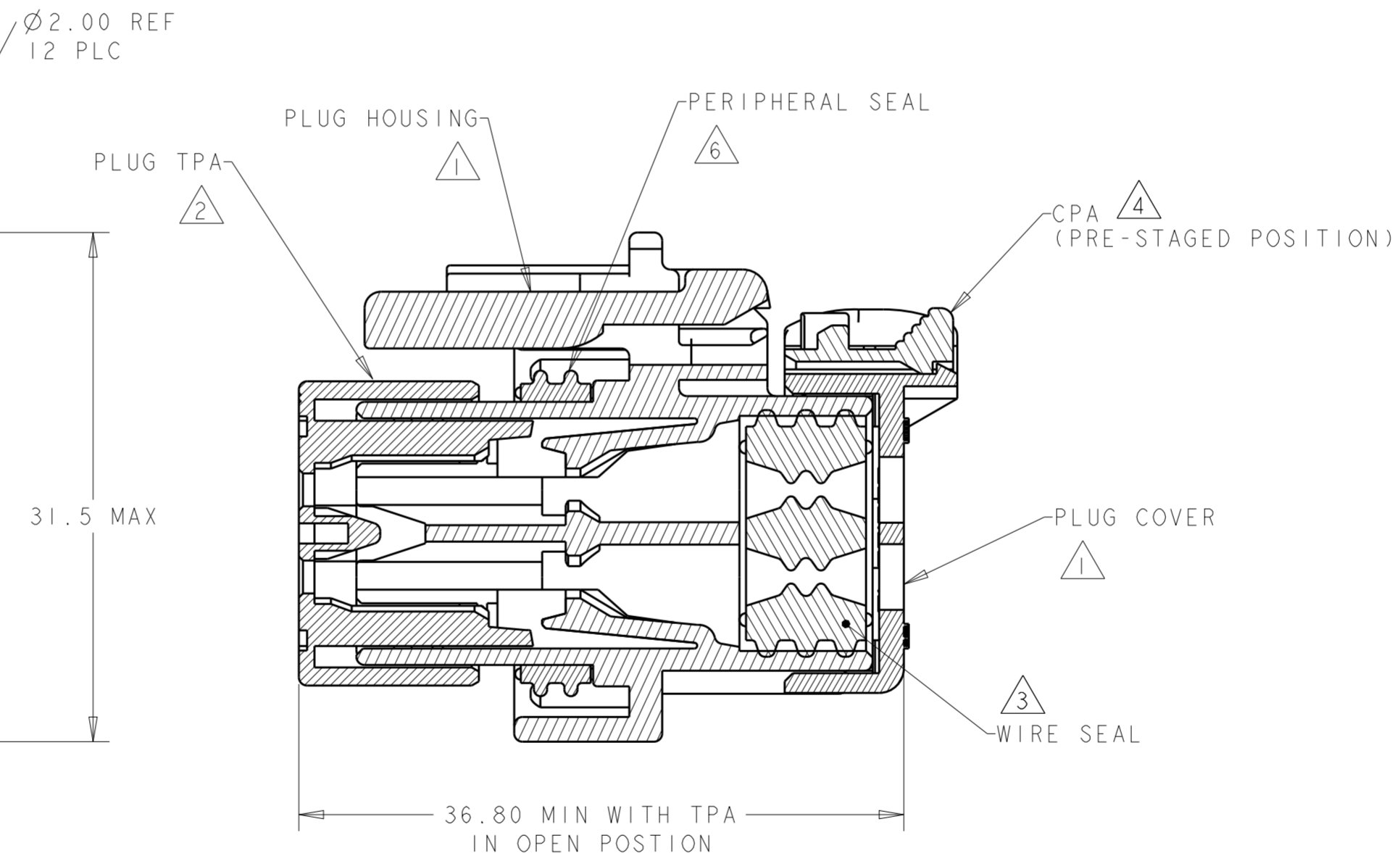

SECTION A-A

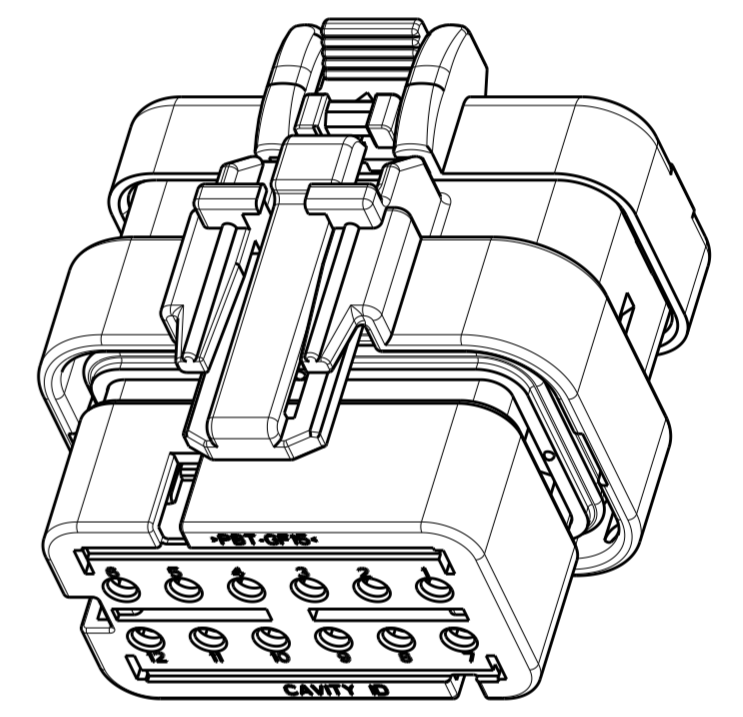

SCALE 2:1

TPA COLOR	PART NUMBER
GREEN	776533-4
YELLOW	776533-3
GRAY	776533-2
RED	776533-1

THIS DRAWING IS A CONTROLLED DOCUMENT.		DWN W. HOELSCHER 03SEP2003	TE Connectivity	
DIMENSIONS: mm		CHK J. PATTERSON 03SEP2003		
TOLERANCES UNLESS OTHERWISE SPECIFIED:		APVD D. KLEIN 03SEP2003	NAME PLUG ASSEMBLY, 12 POSITION, 2 ROW, AMPSEAL 16 CONNECTOR REDUCED DIA WIRE SEAL	
0 PLC ±		PRODUCT SPEC 108-2184	SIZE A2	CAGE CODE -
1 PLC ±		APPLICATION SPEC 114-13065	DRAWING NO G-776533	RESTRICTED TO -
2 PLC ±		WEIGHT 20 ± 1g	SCALE 3:1	SHEET 1
3 PLC ±		Customer Drawing	OF 1	REV E
4 PLC ±				
ANGLES ±				
FINISH -				

Mouser Electronics

Authorized Distributor

Click to View Pricing, Inventory, Delivery & Lifecycle Information:

[TE Connectivity:](#)

[776533-3](#)