

## LMH6503 Wideband, Low Power, Linear Variable Gain Amplifier

Check for Samples: [LMH6503](#)

### FEATURES

- $V_S = \pm 5V$ ,  $T_A = 25^\circ C$ ,  $R_F = 1k\Omega$ ,  $R_G = 174\Omega$ ,  $R_L = 100\Omega$ ,  $A_V = A_{V(MAX)} = 10$ , **Typical Values Unless Specified.**
- **-3dB BW 135MHz**
- **Gain Control BW 100MHz**
- **Adjustment Range (Typical Over Temp) 70dB**
- **Gain Matching (Limit)  $\pm 0.7dB$**
- **Slew Rate 1800V/ $\mu s$**
- **Supply Current (No Load) 37mA**
- **Linear Output Current  $\pm 75mA$**
- **Output Voltage ( $R_L = 100\Omega$ )  $\pm 3.2V$**
- **Input Voltage Noise  $6.6nV/\sqrt{Hz}$**
- **Input Current Noise  $2.4pA/\sqrt{Hz}$**
- **THD (20MHz,  $R_L = 100\Omega$ ,  $V_O = 2V_{PP}$ )  $-57dBc$**
- **Replacement for CLC522**

### APPLICATIONS

- **Variable Attenuator**
- **AGC**
- **Voltage Controller Filter**
- **Multiplier**

### DESCRIPTION

The LMH<sup>TM</sup>6503 is a wideband, DC coupled, differential input, voltage controlled gain stage followed by a high-speed current feedback Op Amp which can directly drive a low impedance load. Gain adjustment range is more than 70dB for up to 10MHz.

Maximum gain is set by external components and the gain can be reduced all the way to cut-off. Power consumption is 370mW with a speed of 135MHz. Output referred DC offset voltage is less than 350mV over the entire gain control voltage range. Device-to-device Gain matching is within 0.7dB at maximum gain. Furthermore, gain at any  $V_G$  is tested and the tolerance is ensured. The output current feedback Op Amp allows high frequency large signals (Slew Rate = 1800V/ $\mu s$ ) and can also drive heavy load current (75mA). Differential inputs allow common mode rejection in low level amplification or in applications where signals are carried over relatively long wires. For single ended operation, the unused input can easily be tied to ground (or to a virtual half-supply in single supply application). Inverting or non-inverting gains could be obtained by choosing one input polarity or the other.

To further increase versatility when used in a single supply application, gain control range is set to be from  $-1V$  to  $+1V$  relative to pin 11 potential (ground pin). In single supply operation, this ground pin is tied to a "virtual" half supply. Gain control pin has high input impedance to simplify its drive requirement. Gain control is linear in  $V/V$  throughout the gain adjustment range. Maximum gain can be set to be anywhere between  $1V/V$  to  $100V/V$  or higher. For linear in dB gain control applications, see LMH6502 datasheet.

The LMH6503 is available in the SOIC-14 and TSSOP-14 package.



Please be aware that an important notice concerning availability, standard warranty, and use in critical applications of Texas Instruments semiconductor products and disclaimers thereto appears at the end of this data sheet.

LMH is a trademark of Texas Instruments.

All other trademarks are the property of their respective owners.

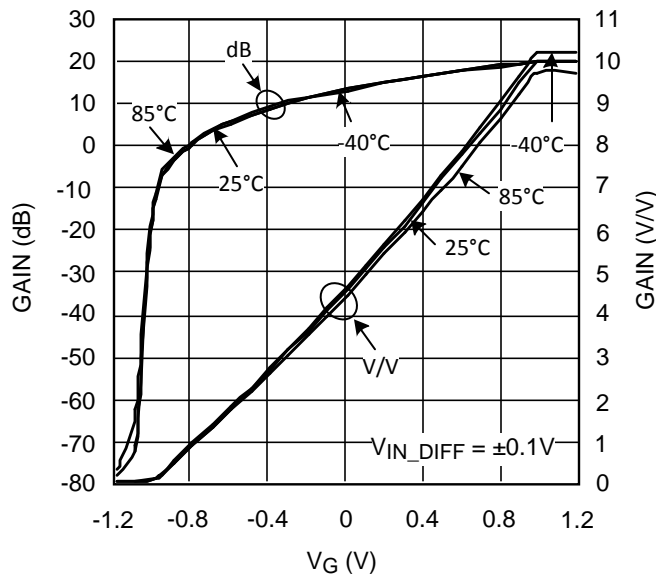

Figure 1. Gain vs.  $V_G$  for Various Temperature

Typical Application

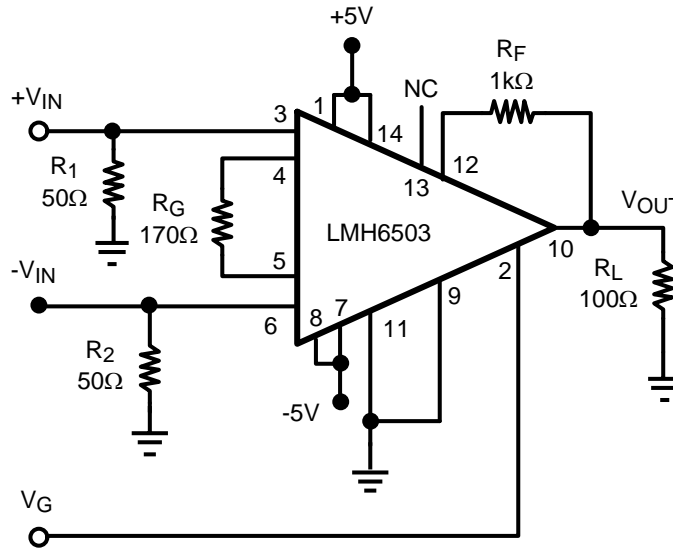

Figure 2.  $A_{VMAX} = 10V/V$



These devices have limited built-in ESD protection. The leads should be shorted together or the device placed in conductive foam during storage or handling to prevent electrostatic damage to the MOS gates.

**Absolute Maximum Ratings<sup>(1)(2)</sup>**

|  |                                 |   |
|--|---------------------------------|---|
| ESD Tolerance: <sup>(3)</sup>                      | Human Body                      | 2KV   |
|  | Machine Model                   | 200V  |
| Input Current                                      |                                 | ±10mA                                       |
| V <sub>IN</sub> Differential                       |                                 | ±(V <sup>+</sup> - V <sup>-</sup> )         |
| Output Current                                     |                                 | 120mA <sup>(4)</sup>                        |
| Supply Voltages (V <sup>+</sup> - V <sup>-</sup> ) |                                 | 12.6V                                       |
| Voltage at Input/ Output pins                      |                                 | V <sup>+</sup> +0.8V, V <sup>-</sup> - 0.8V |
| Soldering Information:                             | Infrared or Convection (20 sec) | 235°C                                       |
|  | Wave Soldering (10 sec)         | 260°C                                       |
| Storage Temperature Range                          |                                 | -65°C to +150°C                             |
| Junction Temperature                               |                                 | +150°C                                      |

- (1) Absolute Maximum Ratings indicate limits beyond which damage to the device may occur. Operating Ratings indicate conditions for which the device is intended to be functional, but specific performance is not ensured. For ensured specifications, see the Electrical Characteristics tables.
- (2) If Military/Aerospace specified devices are required, please contact the Texas Instruments Sales Office/Distributors for availability and specifications.
- (3) Human body model: 1.5kΩ in series with 100pF. Machine model: 0Ω in series with 200pF.
- (4) The maximum output current (I<sub>OUT</sub>) is determined by device power dissipation limitations or value specified, whichever is lower.

**Operating Ratings<sup>(1)</sup>**

|  |                 |                 |
|--|-----------------|-----------------|
| Supply Voltages (V <sup>+</sup> - V <sup>-</sup> ) |                 | 5V to 12V       |
| Temperature Range                                  |                 | -40°C to +85°C  |
| Thermal Resistance:                                | θ <sub>JA</sub> | θ <sub>JC</sub> |
| 14-Pin SOIC  | 138°C/W         | 45°C/W          |
| 14-Pin TSSOP                                       | 160°C/W         | 51°C/W          |

- (1) Absolute Maximum Ratings indicate limits beyond which damage to the device may occur. Operating Ratings indicate conditions for which the device is intended to be functional, but specific performance is not ensured. For ensured specifications, see the Electrical Characteristics tables.

## Electrical Characteristics<sup>(1)</sup>

Unless otherwise specified, all limits ensured for  $T_J = 25^\circ\text{C}$ ,  $V_S = \pm 5\text{V}$ ,  $A_{V(\text{MAX})} = 10$ ,  $V_{\text{CM}} = 0\text{V}$ ,  $R_F = 1\text{k}\Omega$ ,  $R_G = 174\Omega$ ,  $V_{\text{IN\_DIFF}} = \pm 0.1\text{V}$ ,  $R_L = 100\Omega$ ,  $V_G = +1\text{V}$ . **Boldface** limits apply at the temperature extremes.

| Parameter                                 | Test Conditions  | Min <sup>(2)</sup>  | Typ <sup>(2)</sup> | Max <sup>(2)</sup> | Units                  |
|---|--|---|--------------------|--------------------|------------------------|
| <b>Frequency Domain Response</b>          |  |   |                    |                    |                        |
| BW  | -3dB Bandwidth   | $V_{\text{OUT}} < 0.5\text{PP}$   |                    | 135                | MHz                    |
|   |  | $V_{\text{OUT}} < 0.5\text{PP}$ , $A_{V(\text{MAX})} = 100$   |                    | 50                 |                        |
| GF  | Gain Flatness  | $V_{\text{OUT}} < 0.5\text{V}_{\text{PP}}$ ,<br>$-1\text{V} < V_G < 1\text{V}$ , $\pm 0.2\text{dB}$ |                    | 40                 | MHz                    |
| Att Range                                 | Flat Band (Relative to Max Gain)<br>Attenuation Range <sup>(3)</sup> | $\pm 0.2\text{dB}$ Flatness, $f < 30\text{MHz}$   |                    | 20                 | MHz                    |
|   |  | $\pm 0.1\text{dB}$ , $f < 30\text{MHz}$   |                    | 6.6                |                        |
| BW Control                                | Gain Control Bandwidth   | $V_G = 0\text{V}$ <sup>(4)</sup>  |                    | 100                | MHz                    |
| PL  | Linear Phase Deviation   | DC to 60MHz   |                    | 1.6                | deg                    |
| G Delay                                   | Group Delay  | DC to 130MHz  |                    | 2.6                | ns                     |
| CT (dB)                                   | Feed-through   | $V_G = -1.2\text{V}$ , 30MHz (Output Referred)  |                    | -48                | dB                     |
| GR  | Gain Adjustment Range  | $f < 10\text{MHz}$  |                    | 79                 | dB                     |
|   |  | $f < 30\text{MHz}$  |                    | 68                 |                        |
| <b>Time Domain Response</b>               |  |   |                    |                    |                        |
| $t_r$ , $t_f$                             | Rise and Fall Time   | 0.5V Step   |                    | 2.2                | ns                     |
| OS%                                       | Overshoot  | 0.5V Step   |                    | 10                 | %                      |
| SR  | Slew Rate  | 4V Step <sup>(5)</sup>  |                    | 1800               | V/ $\mu\text{s}$       |
| $\Delta\text{G}$ Rate                     | Gain Change Rate   | $V_{\text{IN}} = 0.3\text{V}$ , 10%–90% of final output   |                    | 4.6                | dB/ns                  |
| <b>Distortion &amp; Noise performance</b> |  |   |                    |                    |                        |
| HD2                                       | 2 <sup>nd</sup> Harmonic Distortion                                  | $2V_{\text{PP}}$ , 20MHz  |                    | -60                | dBc                    |
| HD3                                       | 3 <sup>rd</sup> Harmonic Distortion                                  | $2V_{\text{PP}}$ , 20MHz  |                    | -61                | dBc                    |
| THD                                       | Total Harmonic Distortion  | $2V_{\text{PP}}$ , 20MHz  |                    | -57                | dBc                    |
| En tot                                    | Total Equivalent Input Noise   | 1MHz to 150MHz  |                    | 6.6                | nV/ $\sqrt{\text{Hz}}$ |
| $I_n$                                     | Input Noise Current  | 1MHz to 150MHz  |                    | 2.4                | pA/ $\sqrt{\text{Hz}}$ |
| DG  | Differential Gain  | $f = 4.43\text{MHz}$ , $R_L = 150\Omega$ , Neg. Sync  |                    | 0.15               | %                      |
| DP  | Differential Phase   | $f = 4.43\text{MHz}$ , $R_L = 150\Omega$ , Neg. Sync  |                    | 0.22               | deg                    |

- (1) Electrical Table values apply only for factory testing conditions at the temperature indicated. Factory testing conditions result in very limited self-heating of the device such that  $T_J = T_A$ . No ensured specification of parametric performance is indicated in the electrical tables under conditions of internal self-heating where  $T_J > T_A$ .
- (2) Typical values represent the most likely parametric norm. Bold numbers refer to over temperature limits.
- (3) Flat Band Attenuation (Relative To Max Gain) Range Definition: Specified as the attenuation range from maximum which allows gain flatness specified (either  $\pm 0.2\text{dB}$  or  $\pm 0.1\text{dB}$ ), relative to  $A_{V(\text{MAX})}$  gain. For example, for  $f < 30\text{MHz}$ , here are the Flat Band Attenuation ranges:  $\pm 0.2\text{dB}$ : 10V/V down to 1V/V=20dB range  $\pm 0.1\text{dB}$ : 10V/V down to 4.7V/V=6.5dB range
- (4) Gain Control Frequency Response Schematic:

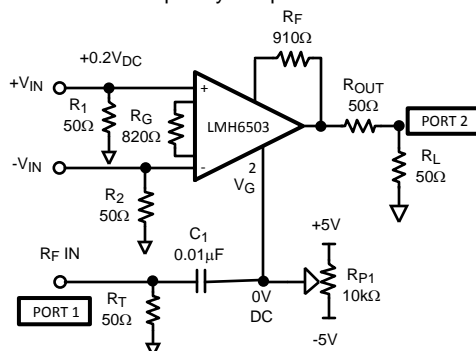

- (5) Slew Rate is the average of the rising and falling rates.

**Electrical Characteristics<sup>(1)</sup> (continued)**

Unless otherwise specified, all limits ensured for  $T_J = 25^\circ\text{C}$ ,  $V_S = \pm 5\text{V}$ ,  $A_{V(\text{MAX})} = 10$ ,  $V_{\text{CM}} = 0\text{V}$ ,  $R_F = 1\text{k}\Omega$ ,  $R_G = 174\Omega$ ,  $V_{\text{IN\_DIFF}} = \pm 0.1\text{V}$ ,  $R_L = 100\Omega$ ,  $V_G = +1\text{V}$ . **Boldface** limits apply at the temperature extremes.

| Parameter                                 | Test Conditions  | Min <sup>(2)</sup>  | Typ <sup>(2)</sup>                         | Max <sup>(2)</sup> | Units                                    |               |
|---|--|---|--|--------------------|--|---------------|
| <b>DC &amp; Miscellaneous Performance</b> |  |   |  |                    |  |               |
| GACCU                                     | Gain Accuracy (see <a href="#">Application Information</a> )   | $V_G = 1.0\text{V}$   |  | +0.25              | +0.9/-0.4                                | dB            |
|   |  | $0\text{V} < V_G < 1\text{V}$   |  | $\pm 0.3$          | +1.3/-1.5                                |               |
|   |  | $-0.7\text{V} < V_G < 1\text{V}$  |  | $\pm 0.4$          | +4.4/-4.3                                |               |
| G Match                                   | Gain Matching (see <a href="#">Application Information</a> )   | $V_G = 1.0$   |  | –                  | $\pm 0.7$                                | dB            |
|   |  | $0 < V_G < 1\text{V}$   |  | –                  | +1.7/-1.1                                |               |
|   |  | $-0.7\text{V} < V_G < 1\text{V}$  |  | –                  | +4.0/-4.7                                |               |
| K   | Gain Multiplier (see <a href="#">Application Information</a> ) |   | 1.58<br><b>1.58</b>                        | 1.72               | 1.87<br><b>1.91</b>                      | V/V           |
| $V_{\text{CM}}$                           | Input Voltage Range  | Pin 3 & 6 Common Mode, $ \text{CMRR}  > 50\text{dB}$ <sup>(6)</sup>               | $\pm 2.0$<br><b><math>\pm 1.80</math></b>  | $\pm 2.2$          |  | V             |
| $V_{\text{IN\_DIFF}}$                     | Differential Input Voltage                                     | Across pins 3 & 6   | $\pm 0.34$<br><b><math>\pm 0.28</math></b> | $\pm 0.37$         |  | V             |
| $I_{\text{RG MAX}}$                       | $R_G$ Current  | Pins 4 & 5  | $\pm 1.70$<br><b><math>\pm 1.60</math></b> | $\pm 2.30$         |  | mA            |
| $I_{\text{BIAS}}$                         | Bias Current   | Pins 3 & 6 <sup>(7)</sup>   |  | 11                 | 18<br><b>20</b>                          | $\mu\text{A}$ |
|   |  | Pins 3 & 6 <sup>(7)</sup> ,<br>$V_S = \pm 2.5\text{V}$                            |  | 3                  | 10<br><b>13</b>                          |               |
| $\text{TC}_{\text{BIAS}}$                 | Bias Current Drift   | Pin 3 & 6 <sup>(8)</sup>  |  | 100                |  | nA/°C         |
| $I_{\text{OFF}}$                          | Offset Current   | Pin 3 & 6   |  | 0.01               | 2.0<br><b>2.5</b>                        | $\mu\text{A}$ |
| $\text{TC}_{\text{I OFF}}$                | Offset Current Drift   | See <sup>(8)</sup>  |  | 5                  |  | nA/°C         |
| $R_{\text{IN}}$                           | Input Resistance   | Pin 3 & 6   |  | 750                |  | k $\Omega$    |
| $C_{\text{IN}}$                           | Input Capacitance  | Pin 3 & 6   |  | 5                  |  | pF            |
| $I_{V_G}$                                 | $V_G$ Bias Current   | Pin 2, $V_G = 1.4\text{V}$ <sup>(7)</sup>   |  | 45                 |  | $\mu\text{A}$ |
| $\text{TC}_{I_{V_G}}$                     | $V_G$ Bias Drift   | Pin 2 <sup>(8)</sup>  |  | 20                 |  | nA/°C         |
| $R_{V_G}$                                 | $V_G$ Input Resistance   | Pin 2   |  | 70                 |  | k $\Omega$    |
| $C_{V_G}$                                 | $V_G$ Input Capacitance  | Pin 2   |  | 1.3                |  | pF            |
| $V_{\text{OUT}}$                          | Output Voltage Range   | $R_L = 100\Omega$   | $\pm 3.00$<br><b><math>\pm 2.97</math></b> | $\pm 3.20$         |  | V             |
|   |  | $R_L$ Open  | $\pm 3.95$<br><b><math>\pm 3.90</math></b> | $\pm 4.05$         |  |               |
| $R_{\text{OUT}}$                          | Output Impedance   | DC  |  | 0.1                |  | $\Omega$      |
| $I_{\text{OUT}}$                          | Output Current   | $V_{\text{OUT}} \pm 4\text{V}$ from Rails   | $\pm 75$<br><b><math>\pm 70</math></b>     | $\pm 90$           |  | mA            |
| $V_{\text{O OFFSET}}$                     | Output Offset Voltage  | $-1\text{V} < V_G < 1\text{V}$  |  | $\pm 80$           | $\pm 350$<br><b><math>\pm 380</math></b> | mV            |
| +PSRR                                     | +Power Supply Rejection Ratio (See <sup>(9)</sup> )            | Input Referred, 1V change, $V_G = 1.4\text{V}$                                    |  | -80                | -58<br><b>-56</b>                        | dB            |
| -PSRR                                     | -Power Supply Rejection Ratio (See <sup>(9)</sup> )            | Input Referred, 1V change, $V_G = 1.4\text{V}$                                    |  | -67                | -57<br><b>-51</b>                        | dB            |
| CMRR                                      | Common Mode Rejection Ratio (See <sup>(10)</sup> )             | Input Referred, $V_G = 1\text{V}$<br>$-1.8\text{V} < V_{\text{CM}} < 1.8\text{V}$ |  | -67                |  | dB            |

(6) CMRR definition:  $[\Delta V_{\text{OUT}}/\Delta V_{\text{CM}}/A_V]$  with 0.1V differential input voltage.  $\Delta V_{\text{OUT}}$  is the change in output voltage with offset shift subtracted out.

(7) Positive current corresponds to current flowing in the device.

(8) Drift determined by dividing the change in parameter distribution at temperature extremes by the total temperature change.

(9) +PSRR definition:  $[\Delta V_{\text{OUT}}/\Delta V^+]/A_V$ , -PSRR definition:  $[\Delta V_{\text{OUT}}/\Delta V^-]/A_V$  with 0.1V differential input voltage.  $\Delta V_{\text{OUT}}$  is the change in output voltage with offset shift subtracted out.

(10) CMRR definition:  $[\Delta V_{\text{OUT}}/\Delta V_{\text{CM}}/A_V]$  with 0.1V differential input voltage.  $\Delta V_{\text{OUT}}$  is the change in output voltage with offset shift subtracted out.

**Electrical Characteristics<sup>(1)</sup> (continued)**

Unless otherwise specified, all limits ensured for  $T_J = 25^\circ\text{C}$ ,  $V_S = \pm 5\text{V}$ ,  $A_{V(\text{MAX})} = 10$ ,  $V_{\text{CM}} = 0\text{V}$ ,  $R_F = 1\text{k}\Omega$ ,  $R_G = 174\Omega$ ,  $V_{\text{IN\_DIFF}} = \pm 0.1\text{V}$ ,  $R_L = 100\Omega$ ,  $V_G = +1\text{V}$ . **Boldface** limits apply at the temperature extremes.

| Parameter |                | Test Conditions                            | Min <sup>(2)</sup> | Typ <sup>(2)</sup> | Max <sup>(2)</sup> | Units |
|-----------|----------------|--|--------------------|--------------------|--------------------|-------|
| $I_S$     | Supply Current | $R_L = \text{Open}$                        |                    | 37                 | 50<br><b>53</b>    | mA    |
|           |                | $R_L = \text{Open}, V_S = \pm 2.5\text{V}$ |                    | 12                 | 20<br><b>23</b>    |       |

**Connection Diagram**

**Top View**

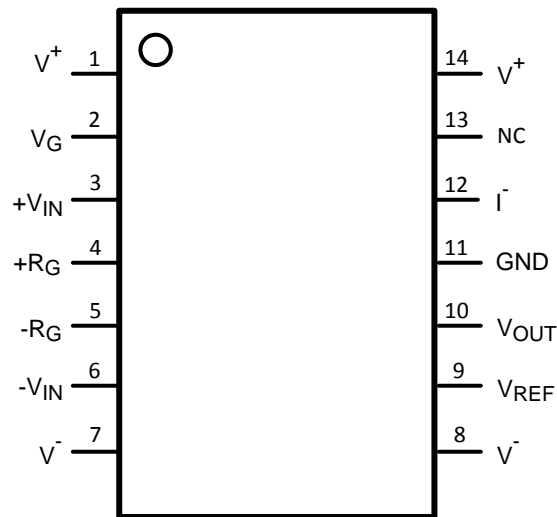

**Figure 3. 14-Pin SOIC AND TSSOP Packages  
See Package Numbers D0014A and PW0014A**

### Typical Performance Charateristics

Unless otherwise specified:  $V_S = \pm 5V$ ,  $25^\circ C$ ,  $V_G = V_{G\_MAX}$ ,  $V_{CM} = 0V$ ,  $R_F = 1k\Omega$ ,  $R_G = 174\Omega$ , both inputs terminated in  $50\Omega$ ,  $R_L = 100\Omega$ , Typical values, results referred to device output:

Small Signal Frequency Response ( $A_V = 2$ )

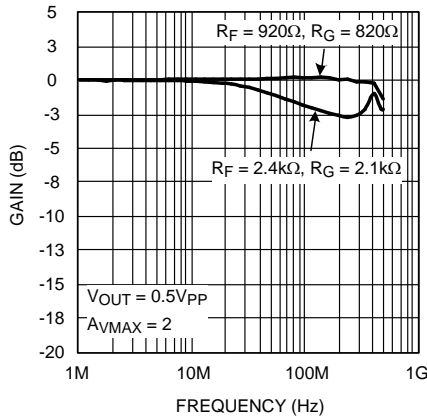

Figure 4.

Large Signal Frequency Response ( $A_V = 2$ )

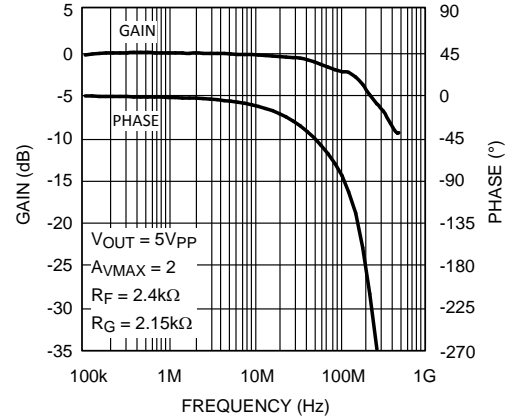

Figure 5.

Frequency Response over Temperature ( $A_V = 10$ )

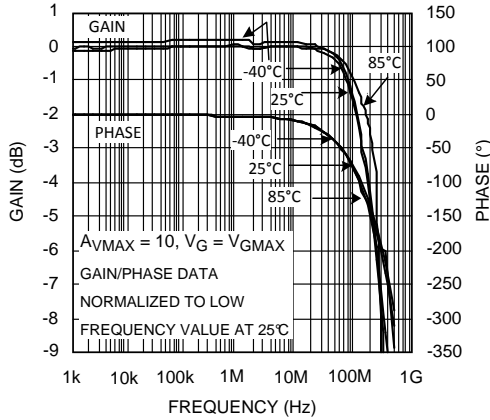

Figure 6.

Frequency Response for Various  $V_G$  ( $A_V_{MAX} = 10$ )

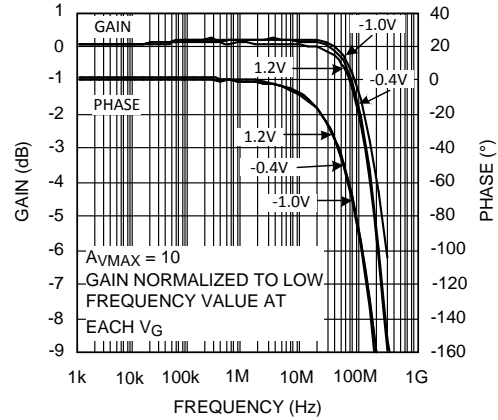

Figure 7.

Frequency Response for Various  $V_G$  ( $A_V_{MAX} = 10$ ) ( $\pm 2.5V$ )

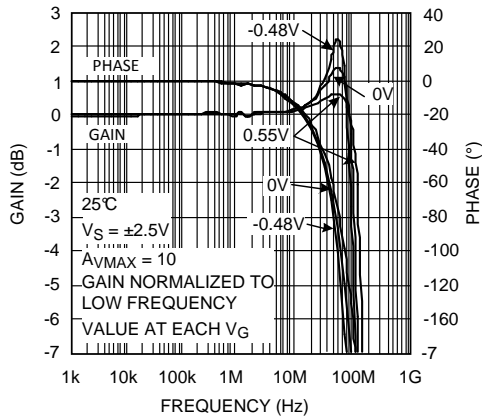

Figure 8.

Small Signal Frequency Response

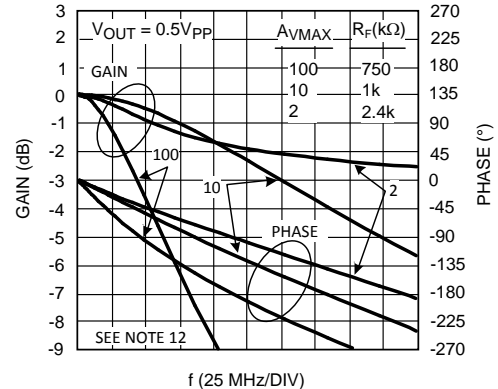

Figure 9.

Typical Performance Characteristics (continued)

Unless otherwise specified:  $V_S = \pm 5V$ ,  $25^\circ C$ ,  $V_G = V_{G\_MAX}$ ,  $V_{CM} = 0V$ ,  $R_F = 1k\Omega$ ,  $R_G = 174\Omega$ , both inputs terminated in  $50\Omega$ ,  $R_L = 100\Omega$ , Typical values, results referred to device output:

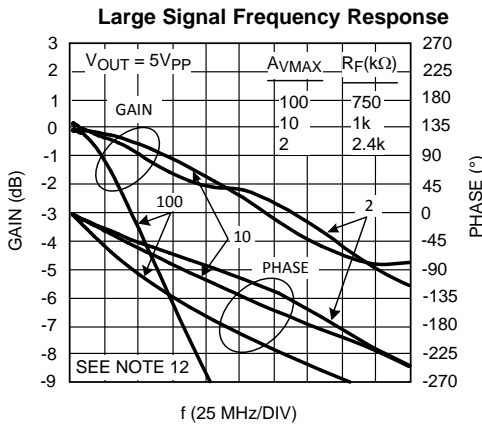

Figure 10.

Frequency Response for Various  $V_G$  ( $A_{VMAX} = 100$ ) (Small Signal)

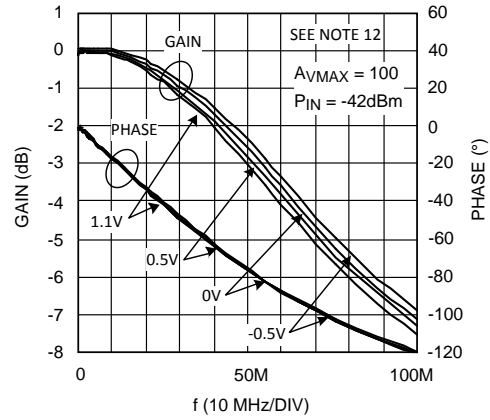

Figure 11.

Frequency Response for Various  $V_G$  ( $A_{VMAX} = 100$ ) (Large Signal)

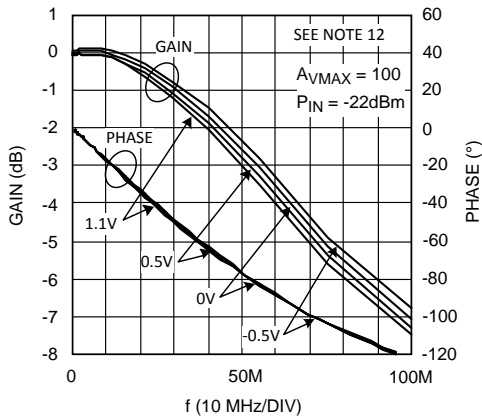

Figure 12.

Gain Control Frequency Response

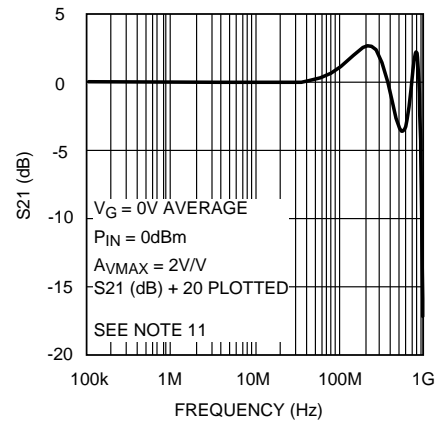

Figure 13.

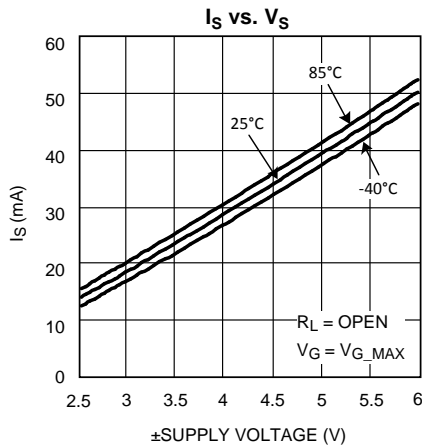

Figure 14.

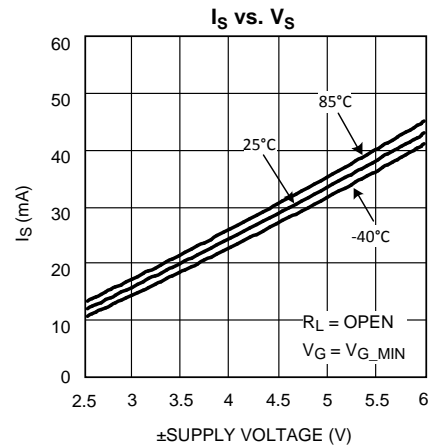

Figure 15.



### Typical Performance Characteristics (continued)

Unless otherwise specified:  $V_S = \pm 5V$ ,  $25^\circ C$ ,  $V_G = V_{G\_MAX}$ ,  $V_{CM} = 0V$ ,  $R_F = 1k\Omega$ ,  $R_G = 174\Omega$ , both inputs terminated in  $50\Omega$ ,  $R_L = 100\Omega$ , Typical values, results referred to device output:

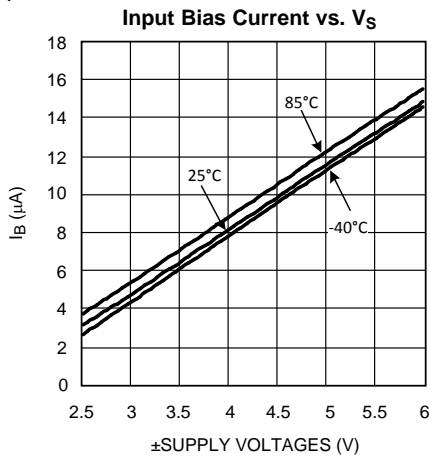

Figure 16.

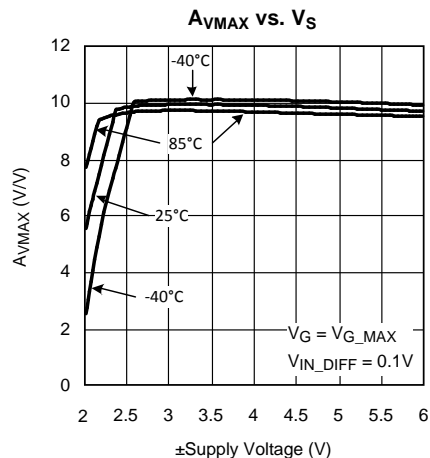

Figure 17.

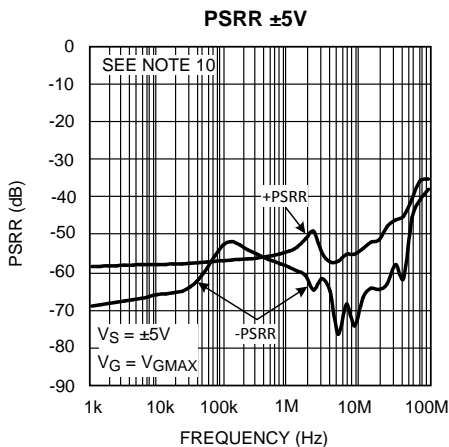

Figure 18.

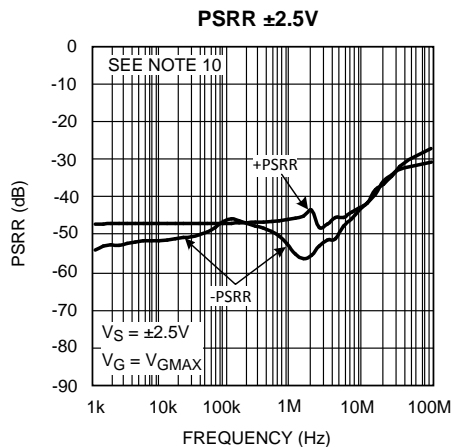

Figure 19.

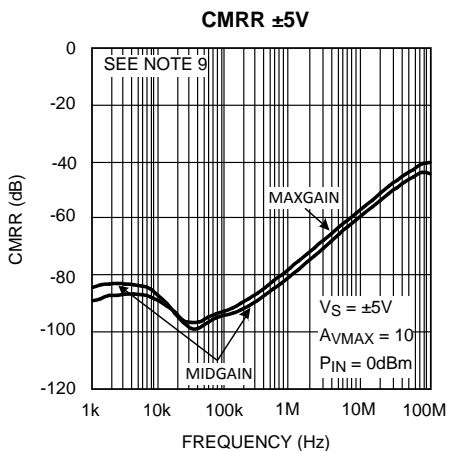

Figure 20.

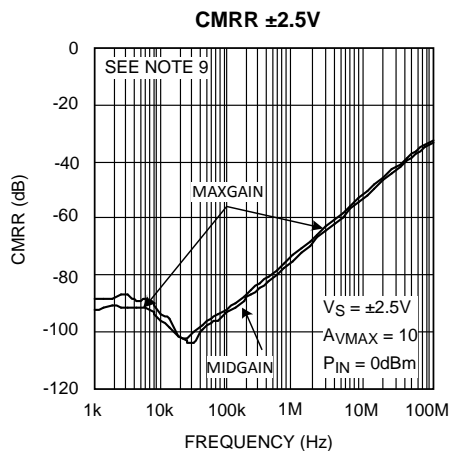

Figure 21.

**Typical Performance Charateristics (continued)**

Unless otherwise specified:  $V_S = \pm 5V$ ,  $25^\circ C$ ,  $V_G = V_{G\_MAX}$ ,  $V_{CM} = 0V$ ,  $R_F = 1k\Omega$ ,  $R_G = 174\Omega$ , both inputs terminated in  $50\Omega$ ,  $R_L = 100\Omega$ , Typical values, results referred to device output:

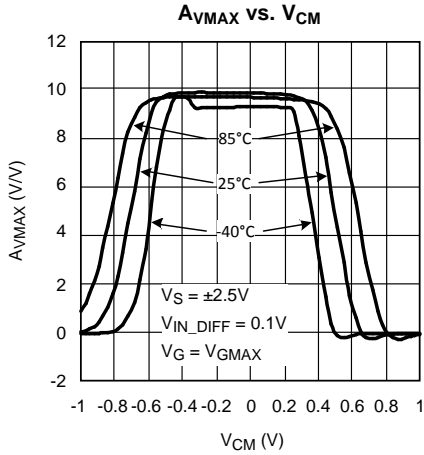

Figure 22.

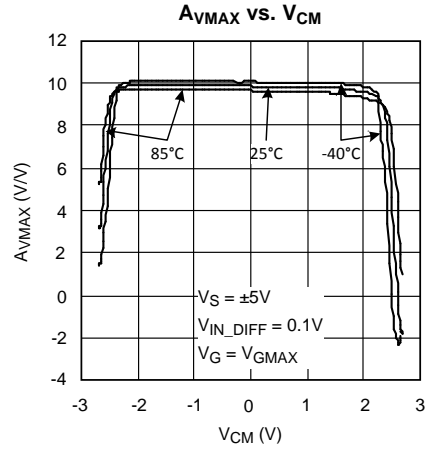

Figure 23.

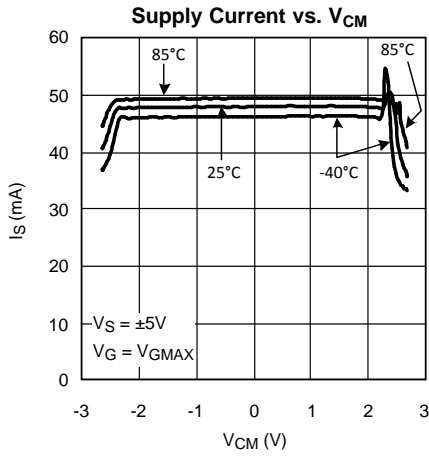

Figure 24.

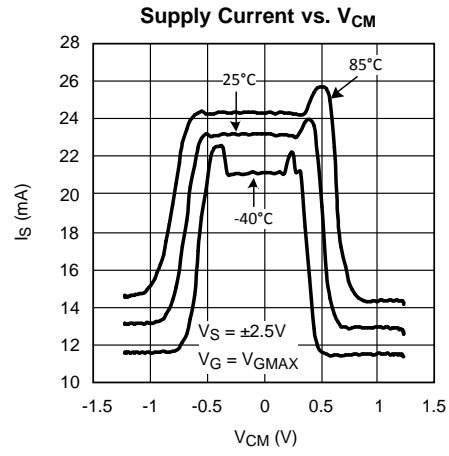

Figure 25.

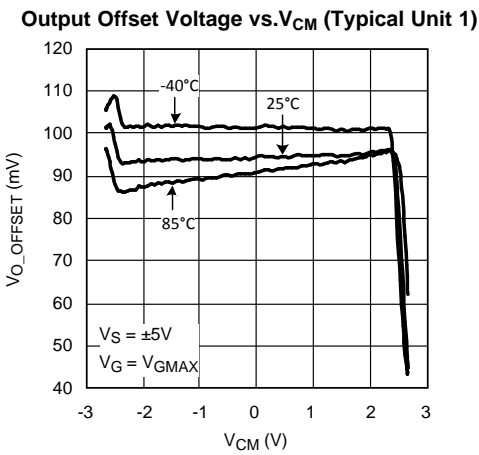

Figure 26.

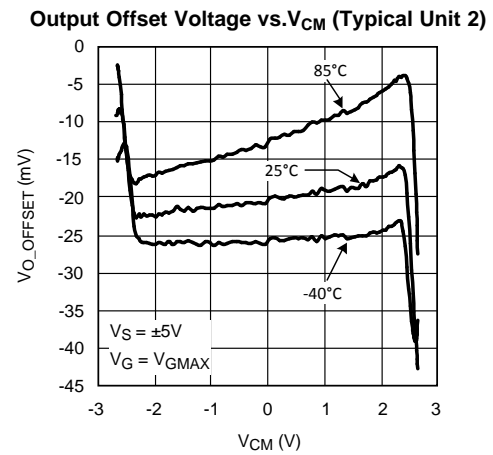

Figure 27.

### Typical Performance Characteristics (continued)

Unless otherwise specified:  $V_S = \pm 5V$ ,  $25^\circ C$ ,  $V_G = V_{G\_MAX}$ ,  $V_{CM} = 0V$ ,  $R_F = 1k\Omega$ ,  $R_G = 174\Omega$ , both inputs terminated in  $50\Omega$ ,  $R_L = 100\Omega$ , Typical values, results referred to device output:

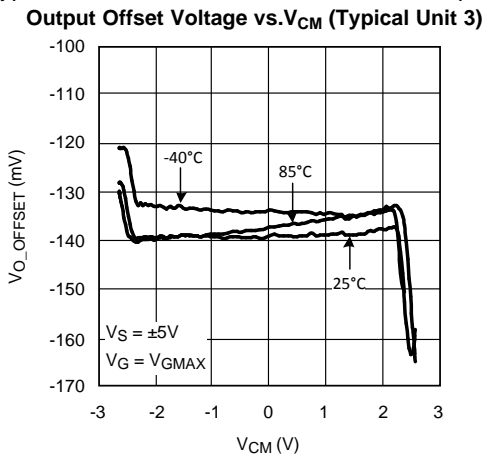

Figure 28.

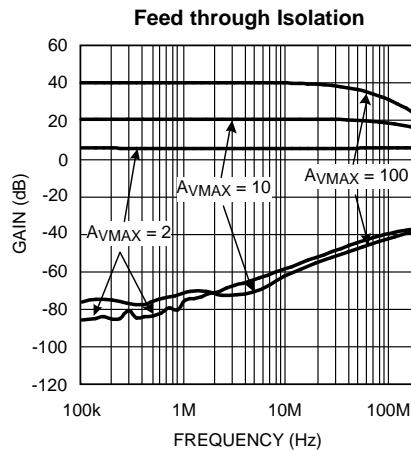

Figure 29.

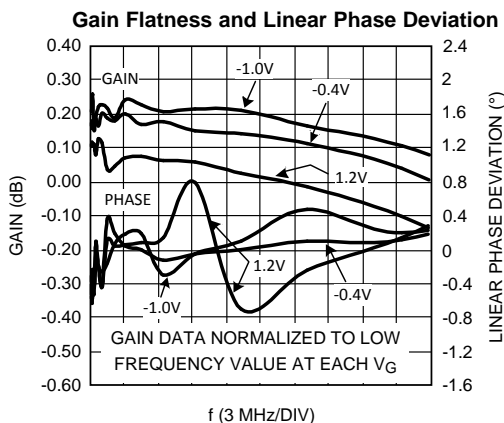

Figure 30.

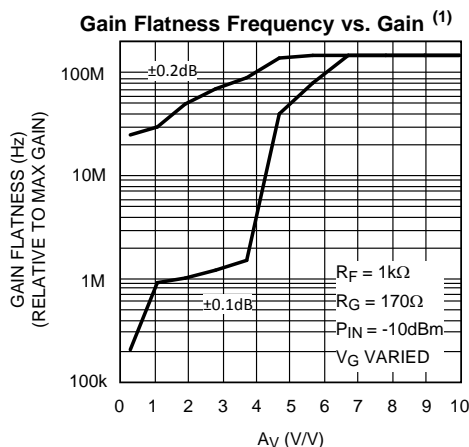

Figure 31.

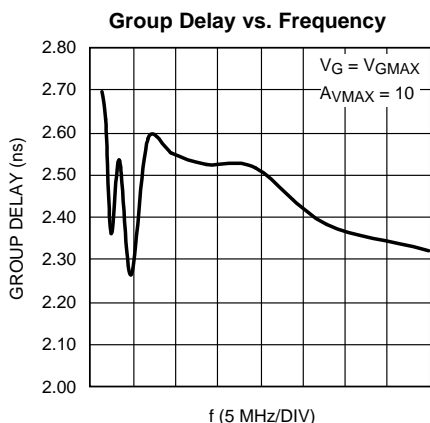

Figure 32.

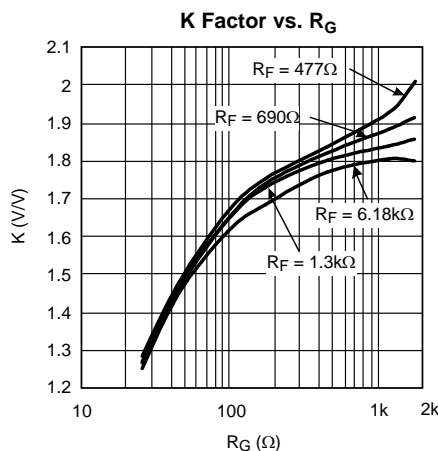

Figure 33.

(1) Flat Band Attenuation (Relative To Max Gain) Range Definition: Specified as the attenuation range from maximum which allows gain flatness specified (either  $\pm 0.2dB$  or  $\pm 0.1dB$ ), relative to  $A_{V\_MAX}$  gain. For example, for  $f < 30MHz$ , here are the Flat Band Attenuation ranges:  $\pm 0.2dB$ :  $10V/V$  down to  $1V/V = 20dB$  range  $\pm 0.1dB$ :  $10V/V$  down to  $4.7V/V = 6.5dB$  range

**Typical Performance Characteristics (continued)**

Unless otherwise specified:  $V_S = \pm 5V$ ,  $25^\circ C$ ,  $V_G = V_{G\_MAX}$ ,  $V_{CM} = 0V$ ,  $R_F = 1k\Omega$ ,  $R_G = 174\Omega$ , both inputs terminated in  $50\Omega$ ,  $R_L = 100\Omega$ , Typical values, results referred to device output:

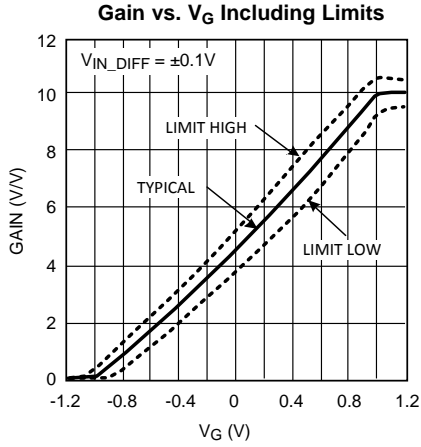

Figure 34.

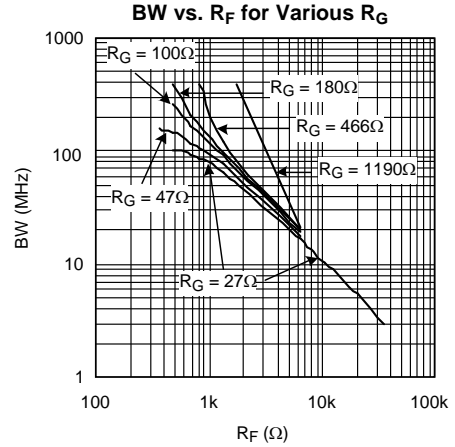

Figure 35.

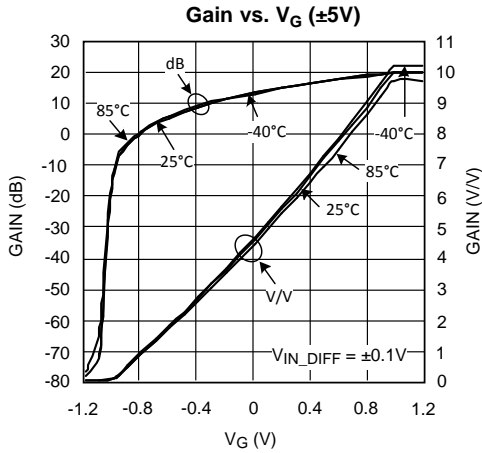

Figure 36.

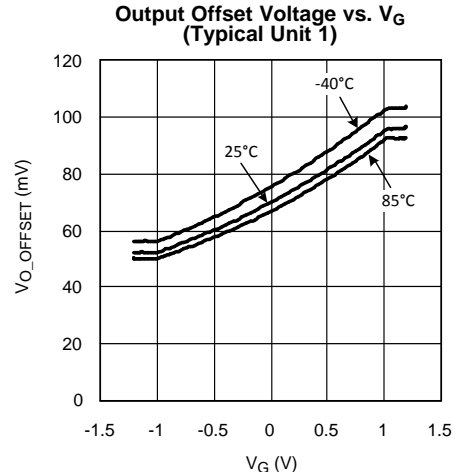

Figure 37.

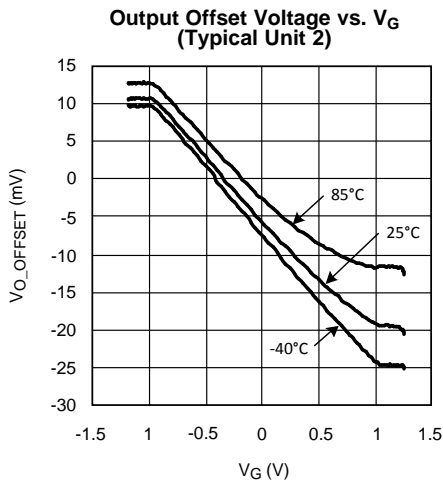

Figure 38.

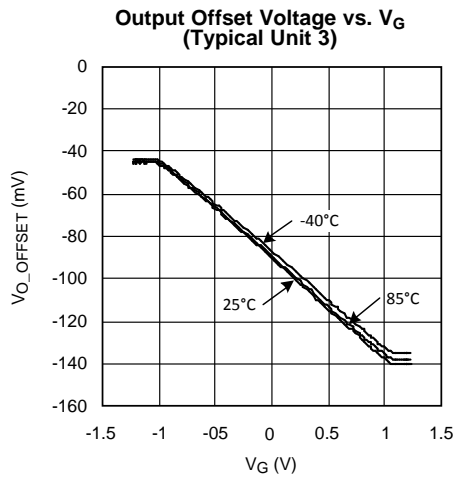

Figure 39.

Typical Performance Characteristics (continued)

Unless otherwise specified:  $V_S = \pm 5V$ ,  $25^\circ C$ ,  $V_G = V_{G\_MAX}$ ,  $V_{CM} = 0V$ ,  $R_F = 1k\Omega$ ,  $R_G = 174\Omega$ , both inputs terminated in  $50\Omega$ ,  $R_L = 100\Omega$ , Typical values, results referred to device output:

Output Offset Voltage vs.  $\pm V_S$  for Various  $V_G$  (Typical Unit 1)

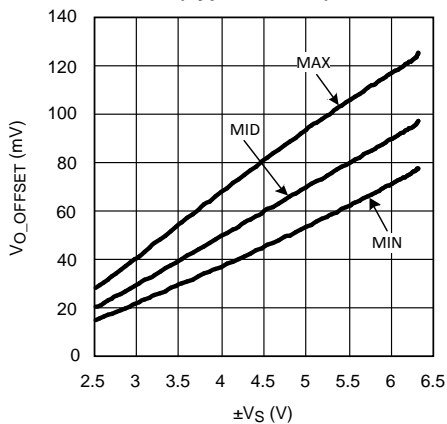

Figure 40.

Output Offset Voltage vs.  $\pm V_S$  for Various  $V_G$  (Typical Unit 2)

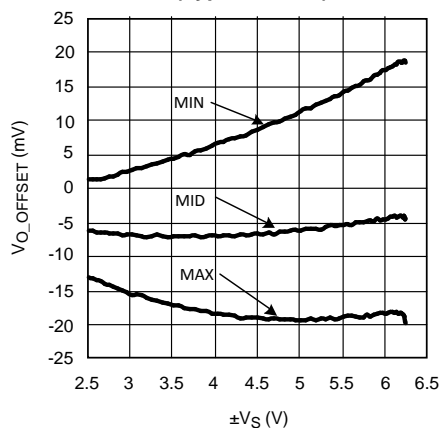

Figure 41.

Output Offset Voltage vs.  $\pm V_S$  for Various  $V_G$  (Typical Unit 3)

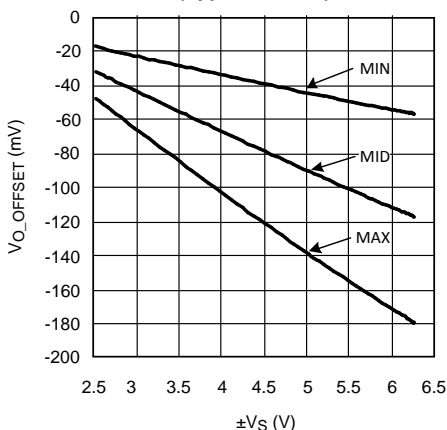

Figure 42.

Gain vs.  $V_G (\pm 2.5V)$

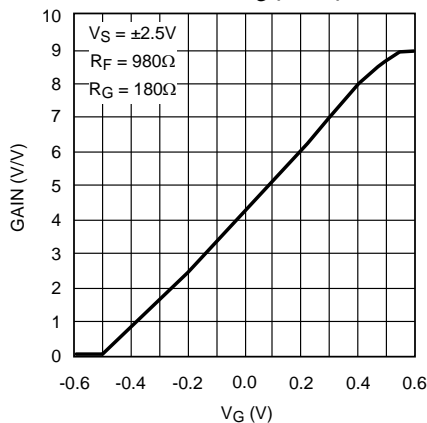

Figure 43.

Noise vs. Frequency ( $A_{VMAX} = 2$ )

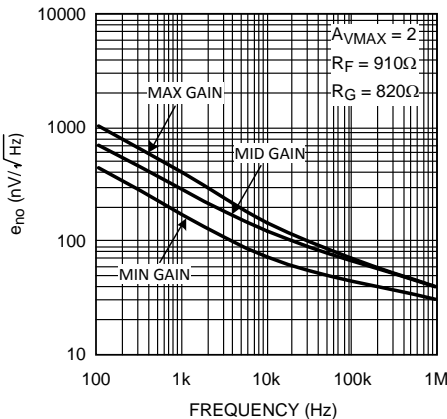

Figure 44.

Noise vs. Frequency ( $A_{VMAX} = 10$ )

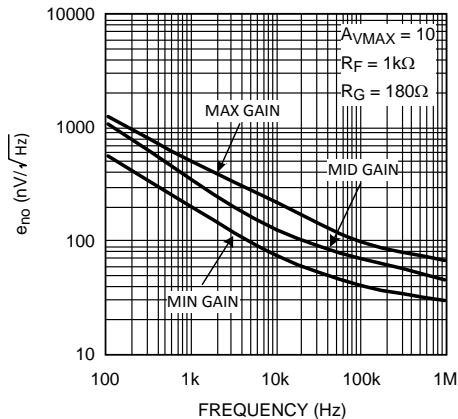

Figure 45.

**Typical Performance Charateristics (continued)**

Unless otherwise specified:  $V_S = \pm 5V$ ,  $25^\circ C$ ,  $V_G = V_{G\_MAX}$ ,  $V_{CM} = 0V$ ,  $R_F = 1k\Omega$ ,  $R_G = 174\Omega$ , both inputs terminated in  $50\Omega$ ,  $R_L = 100\Omega$ , Typical values, results referred to device output:

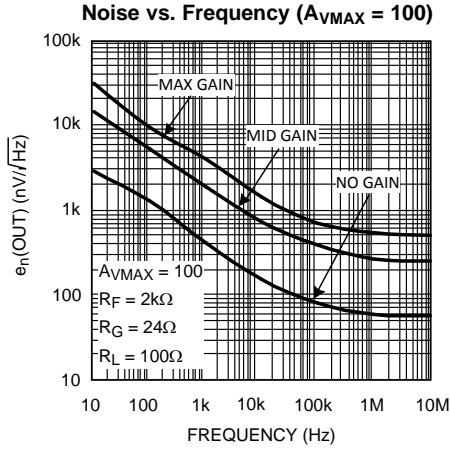

Figure 46.

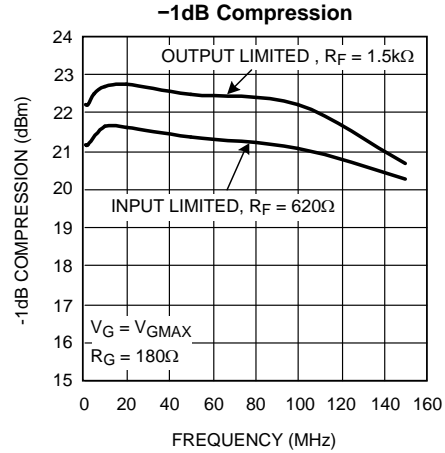

Figure 47.

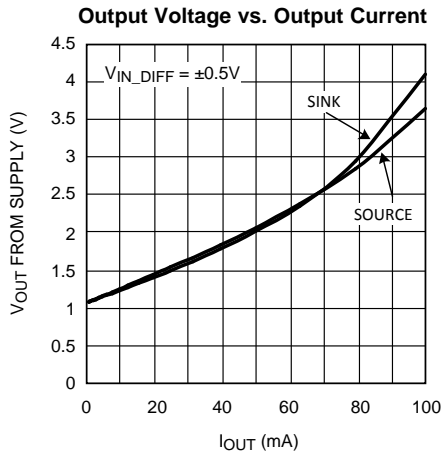

Figure 48.

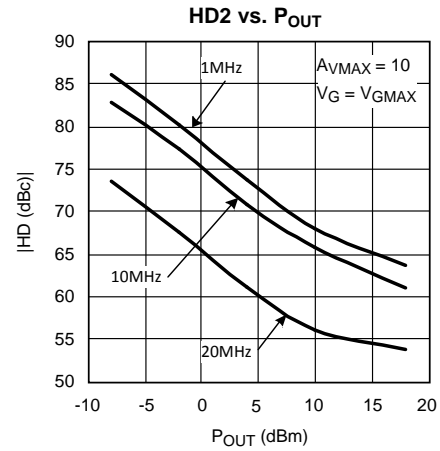

Figure 49.

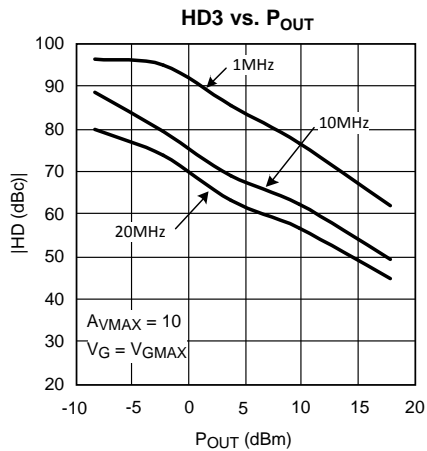

Figure 50.

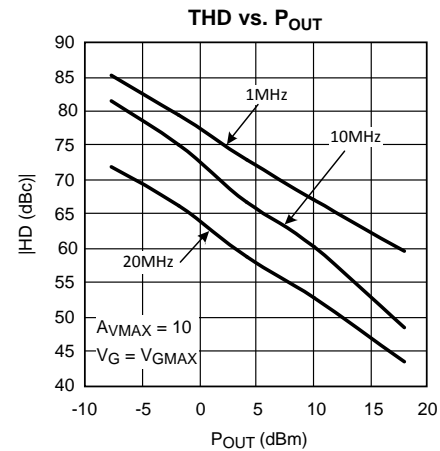

Figure 51.

Typical Performance Characteristics (continued)

Unless otherwise specified:  $V_S = \pm 5V$ ,  $25^\circ C$ ,  $V_G = V_{G\_MAX}$ ,  $V_{CM} = 0V$ ,  $R_F = 1k\Omega$ ,  $R_G = 174\Omega$ , both inputs terminated in  $50\Omega$ ,  $R_L = 100\Omega$ , Typical values, results referred to device output:

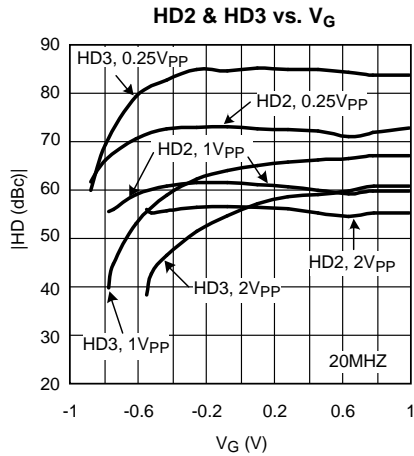

Figure 52.

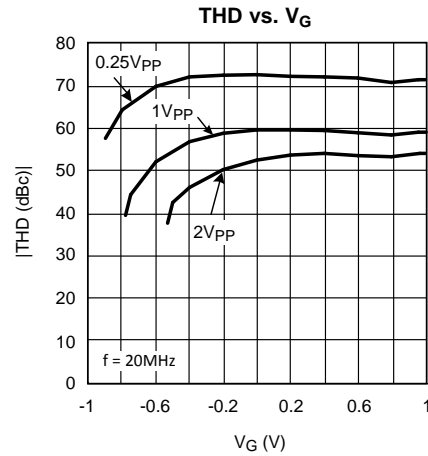

Figure 53.

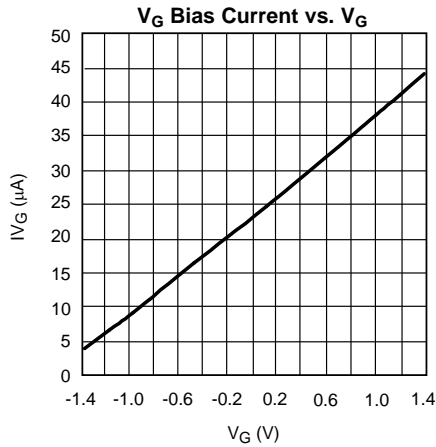

Figure 54.

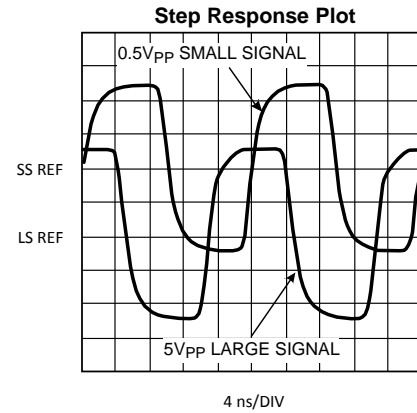

Figure 55.

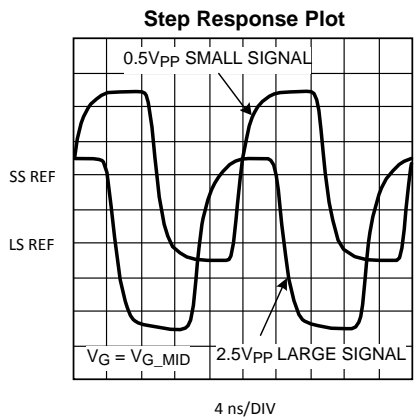

Figure 56.

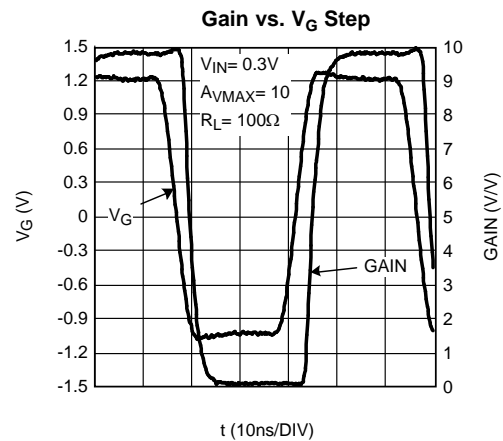
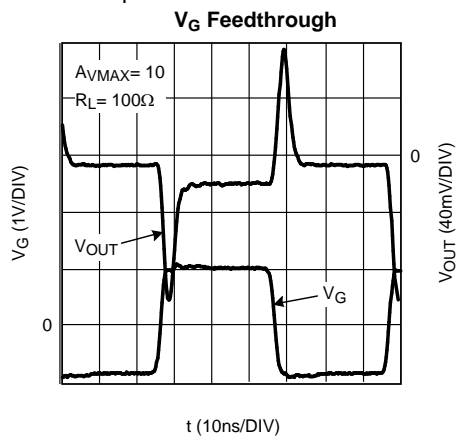

Figure 57.

### Typical Performance Characteristics (continued)

Unless otherwise specified:  $V_S = \pm 5V$ ,  $25^\circ C$ ,  $V_G = V_{G\_MAX}$ ,  $V_{CM} = 0V$ ,  $R_F = 1k\Omega$ ,  $R_G = 174\Omega$ , both inputs terminated in  $50\Omega$ ,  $R_L = 100\Omega$ , Typical values, results referred to device output:



**Figure 58.**



## APPLICATION INFORMATION

### THEORY OF OPERATION

The LMH6503 is a linear wideband variable-gain amplifier as illustrated in [Figure 59](#). A voltage input signal may be applied differentially between the two inputs (+V<sub>IN</sub>, -V<sub>IN</sub>), or single-endedly by grounding one of the two unused inputs. The LMH6503 input buffers convert the input voltage to a current (I<sub>RG</sub>) that is a function of the differential input voltage (V<sub>INPUT</sub> = (+V<sub>IN</sub>) - (-V<sub>IN</sub>)) and the value of the gain setting resistor (R<sub>G</sub>). This current (I<sub>RG</sub>) is then mirrored to a gain stage with a current gain of K (1.72 nominal). The voltage controlled two-quadrant multiplier attenuates this current which is then converted to a voltage via the output amplifier. This output amplifier is a current feedback op amp configured as a Transimpedance amplifier. Its Transimpedance gain is the feedback resistor (R<sub>F</sub>). The input signal, output, and gain control are all voltages. The output voltage can easily be calculated as shown in [Equation 1](#):

$$V_{OUT} = I_{RG} \times K \times \left[ \frac{V_G + 1}{2} \right] \times R_F \quad \text{FOR } -1 < V_G < +1 \quad (1)$$

Where K = 1.72 (Nominal)

since:

$$I_{RG} = \frac{V_{INPUT}}{R_G} \quad (2)$$

The gain of the LMH6503 is therefore a function of three external variables: R<sub>G</sub>, R<sub>F</sub>, and V<sub>G</sub> as expressed in [Equation 3](#):

$$A_V = \frac{R_F}{R_G} \times 1.72 \times \left[ \frac{V_G + 1}{2} \right] \quad (3)$$

The gain control voltage (V<sub>G</sub>) has an ideal input range of -1V < V<sub>G</sub> < +1V. At V<sub>G</sub> = +1V, the gain of the LMH6503 is at its maximum as expressed in [Equation 4](#):

$$A_V = 1.72 \frac{R_F}{R_G} \quad (4)$$

Notice also that [Equation 4](#) holds for both differential and single-ended operation.

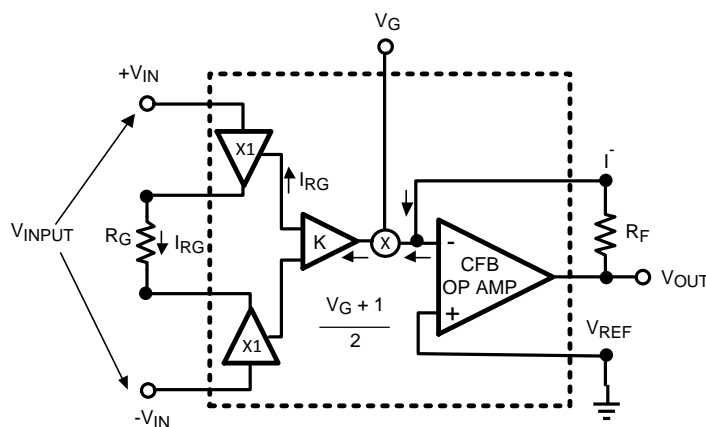

Figure 59. LMH6503 Functional Block Diagram

## CHOOSING $R_F$ AND $R_G$

$R_G$  is calculated using Equation 5.  $V_{\text{INPUTMAX}}$  is the maximum peak input voltage ( $V_{\text{pk}}$ ) determined by the application.  $I_{\text{RGMAX}}$  is the maximum allowable current through  $R_G$  and is typically 2.3mA. Once  $A_{\text{VMAX}}$  is determined from the minimum input and desired output voltages,  $R_F$  is then determined using Equation 6. These values of  $R_F$  and  $R_G$  are the minimum possible values that meet the input voltage and maximum gain constraints. Scaling the resistor values will decrease bandwidth and improve stability.

$$R_G = \frac{V_{\text{INPUTMAX}}}{I_{\text{RGMAX}}} \quad (5)$$

$$R_F = \frac{1}{K} * R_G * A_{\text{VMAX}} \quad (6)$$

Figure 60 illustrates the resulting LMH6503 bandwidths as a function of the maximum (y axis) and minimum (related to x axis) input voltages when  $V_{\text{OUT}}$  is held constant at  $1V_{\text{PP}}$ .

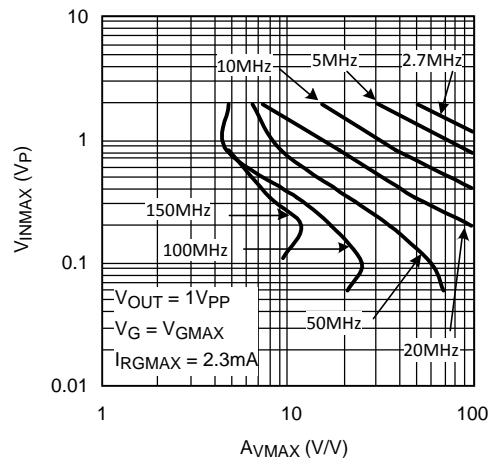

Figure 60. Bandwidth vs.  $V_{\text{INMAX}}$  and  $A_{\text{VMAX}}$

## ADJUSTING OFFSETS

Treating the offsets introduced by the input and output stages of the LMH6503 is accomplished with a two step process. The offset voltage of the output stage is treated by first applying  $-1.1V$  on  $V_G$ , which effectively isolates the input stage and multiplier core from the output stage. As illustrated in Figure 61, the trim pot located at R14 on the LMH6503 Evaluation Board (LMH730033) should then be adjusted in order to null the offset voltage seen at the LMH6503's output (pin 10).

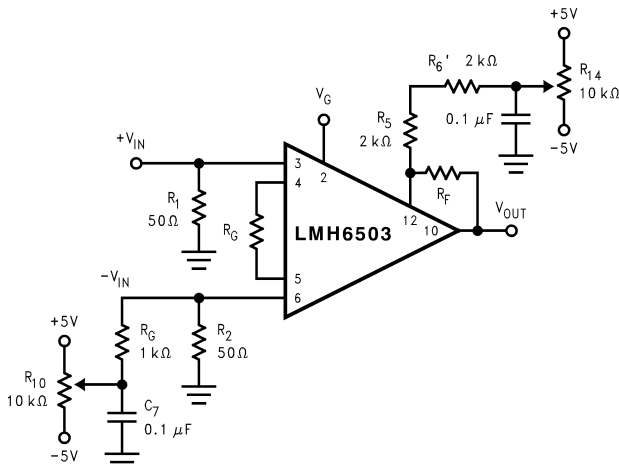

Figure 61. Nulling the Output Offset Voltage

Once this is accomplished, the offset errors introduced by the input stage and multiplier core can then be treated. The second step requires the absence of an input signal and matched source impedances on the two input pins in order to cancel the bias current errors. This done, then +1.1V should be applied to  $V_G$  and the trim pot located at  $R_{10}$  adjusted in order to null the offset voltage seen at the LMH6503's output. If a more limited gain range is anticipated, the above adjustments should be made at these operating points. These steps will minimize the output offset voltage. However, since the offset term itself varies with the gain setting, the correction is not perfect and some residual output offset will remain.

### GAIN ACCURACY

Defined as the ratio of measured gain ( $V/V$ ), at a certain  $V_G$ , to the best fit line drawn through the typical gain ( $V/V$ ) distribution for  $-1V < V_G < 1V$  (results expressed in dB) (See Figure 62). The best fit gain ( $A_V$ ) is given by:

$$A_V (V/V) = 4.87V_G + 4.61 \quad (7)$$

$$\text{For: } -1V \leq V_G \leq +1V, R_F = 1k\Omega, R_G = 174\Omega \quad (8)$$

For a  $V_G$  range, the value specified in the tables represents the worst case accuracy over the entire range. The "Typical" value would be the worst case ratio between the "Typical Gain" and the best fit line. The "Max" value would be the worst case between the max/min gain limit and the best fit line.

### GAIN MATCHING

Defined as the limit on gain variation at a certain  $V_G$  (expressed in dB) (See Figure 62). Specified as "Max" only (no "Typical"). For a  $V_G$  range, the value specified represents the worst case matching over the entire range. The "Max" value would be the worst case ratio between the max/min gain limit and the typical gain.

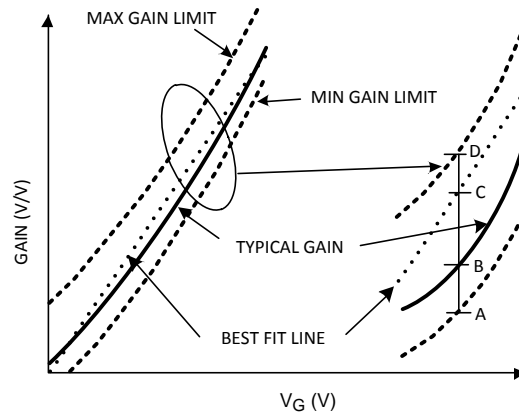

PARAMETER:  
 GAIN ACCURACY (TYPICAL) = B/C (dB)  
 GAIN ACCURACY (+ & - LIMIT) = D/C & A/C (dB)  
 GAIN MATCHING (+ & - LIMIT) = D/B & A/B (dB)

Figure 62. Gain Accuracy and Gain Matching Parameters Defined

NOISE

Figure 63 describes the LMH6503's output-referred spot noise density as a function of frequency with  $A_{VMAX} = 10V/V$ . The plot includes all the noise contributing terms. However, with both inputs terminated in  $50\Omega$ , the input noise contribution is minimal. At  $A_{VMAX} = 10V/V$ , the LMH6503 has a typical flat-band input-referred spot noise density ( $e_{in}$ ) of  $6.6nV/\sqrt{Hz}$ . For applications with  $-3dB$  BW extending well into the flat-band region, the input RMS voltage noise can be determined from the following single-pole model:

$$V_{RMS} = e_{in} * \sqrt{1.57 * (-3dB \text{ BANDWIDTH})} \tag{9}$$

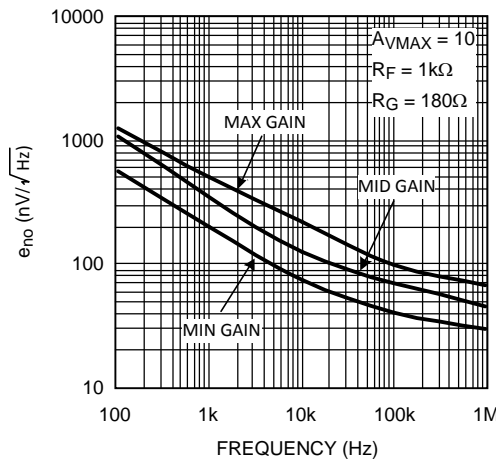
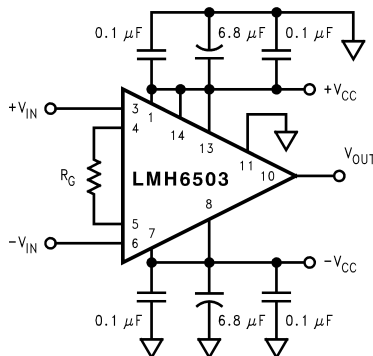

Figure 63. Output Referred Voltage Noise vs. Frequency

## CIRCUIT LAYOUT CONSIDERATIONS

Good high-frequency operation requires all of the de-coupling capacitors shown in [Figure 64](#) to be placed as close as possible to the power supply pins in order to insure a proper high-frequency low-impedance bypass. Adequate ground plane and low inductive power returns are also required of the layout. Minimizing the parasitic capacitances at pins 3, 4, 5, 6, 9, 10 and 12 will assure best high frequency performance. The parasitic inductance of component leads or traces to pins 4, 5 and 9 should also be kept to a minimum. Parasitic or load capacitance,  $C_L$ , on the output (pin 10) degrades phase margin and can lead to frequency response peaking or circuit oscillation. The LMH6503 is fully stable when driving a 100 $\Omega$  load. With reduced load (e.g. 1k $\Omega$ ) there is a possibility of instability at very high frequencies beyond 400MHz especially with a capacitive load. When the LMH6503 is connected to a light load as such, it is recommended to add a snubber network to the output (e.g. 100 $\Omega$  and 39pF in series tied between the LMH6503 output and ground).  $C_L$  can also be isolated from the output by placing a small resistor in series with the output (pin 10).



**Figure 64. Required Power Supply Decoupling**

Component parasitics also influence high frequency results. Therefore it is recommended to use metal film resistors such as RN55D or leadless components such as surface mount devices. High profile sockets are not recommended.

Texas Instruments suggests the following evaluation board as a guide for high frequency layout and as an aid in device testing and characterization:

| Device    | Package | Evaluation Board Part Number |
|-----------|---------|------------------------------|
| LMH6503MA | SOIC-14 | LMH730033                    |

## SINGLE SUPPLY OPERATION

It is possible to operate the LMH6503 with a single supply. To do so, tie pin 11 (GND) to a potential about mid point between  $V^+$  and  $V^-$ . Two examples are shown in [Figure 65](#) & [Figure 66](#).

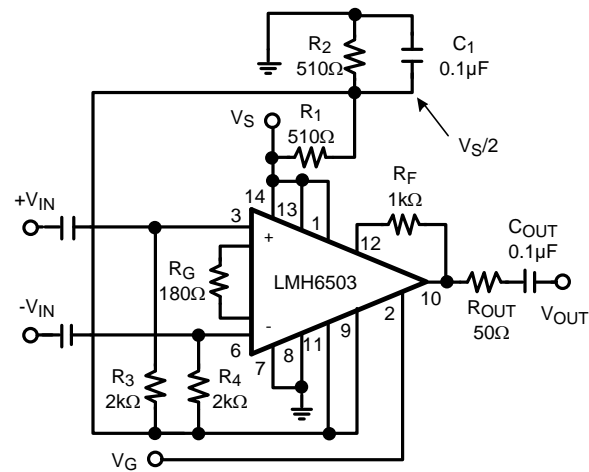

RANGE:  $\pm 1\text{V}$  FROM PIN 11  
VOLTAGE (FOR  $V_S = 10\text{V}$ )

**Figure 65. AC Coupled Single Supply VGA**

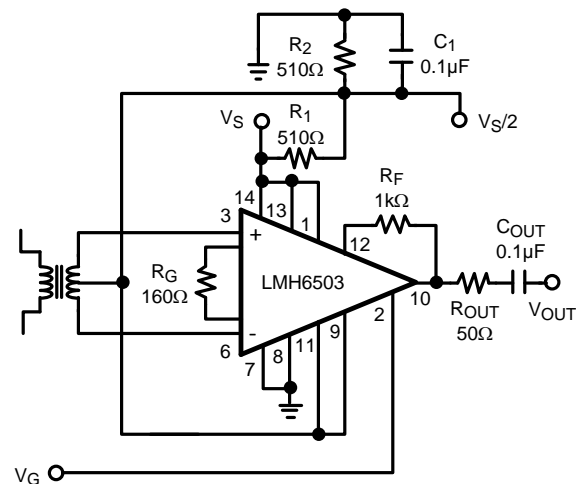

**Figure 66. Transformer Coupled Single Supply VGA**

## OPERATING AT LOWER SUPPLY VOLTAGES

The LMH6503 is rated for operation down to 5V supplies ( $V^+ - V^-$ ). There are some specifications shown for operation at  $\pm 2.5\text{V}$  within the data sheet (i.e. Frequency Response, CMRR, PSRR, Gain vs.  $V_G$ , etc.). Compared to  $\pm 5\text{V}$  operation, at lower supplies:

- a)  $V_G$  range constricts. Referring to [Figure 67](#), note that  $V_{G\_MAX}$  ( $V_G$  voltage required to get maximum gain) is  $0.5\text{V}$  ( $V_S = \pm 2.5\text{V}$ ) compared to  $1.0\text{V}$  for  $V_S = \pm 5\text{V}$ . At the same time, gain cut-off ( $V_{G\_MIN}$ ) would shift to  $-0.5\text{V}$  from  $-1\text{V}$  with  $V_S = \pm 5\text{V}$ .

[Table 1](#) shows the approximate expressions for various  $V_G$  voltages as a function of  $V^-$ :

Table 1.  $V_G$  Definition Based on  $V^-$

| $V_G$        | Definition   | Expression (V)    |
|--------------|--------------|-------------------|
| $V_{G\_MIN}$ | Gain Cut-off | $0.2 \times V^-$  |
| $V_{G\_MID}$ | $A_{VMAX}/2$ | 0                 |
| $V_{G\_MAX}$ | $A_{VMAX}$   | $-0.2 \times V^-$ |

- b)  $V_{G\_LIMIT}$  (maximum permissible voltage on  $V_G$ ) is reduced. This is due to limitations within the device arising from transistor headroom. Beyond this limit, device performance will be affected (non-destructive). Referring to Figure 67, note that with  $V^+ = 2.5V$ , and  $V^- = -4V$ ,  $V_{G\_LIMIT}$  is approaching  $V_{G\_MAX}$  and already "Max gain" is reduced by 1dB. This means that operating under these conditions has reduced the maximum permissible voltage on  $V_G$  to a level below what is needed to get Max gain. If supply voltages are asymmetrical, reference Figure 67 and Figure 68 plots to make sure the region of operation is not overly restricted by the "pinching" of  $V_{G\_LIMIT}$ , and  $V_{G\_MAX}$  curves.
- c) "Max\_gain" reduces. There is an intrinsic reduction in max gain when the total supply voltage is reduced (see Figure 43). In addition, there is the more drastic mechanism described in "b" above and shown in Figure 67.

Similar plots for  $V^+ = 5V$  operation are shown in Figure 68 for comparison and reference.

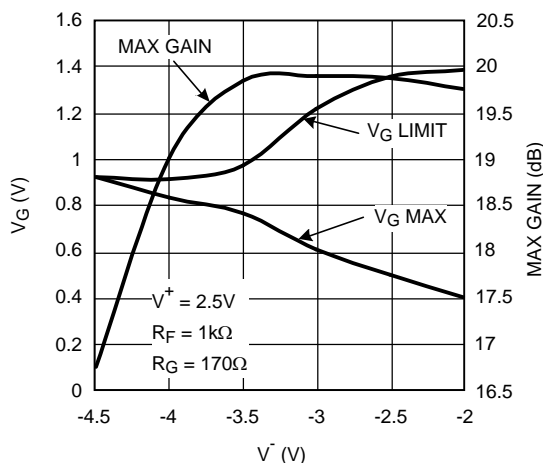

Figure 67.  $V_{G\_MAX}$ ,  $V_{G\_LIMIT}$ , & Max-gain vs.  $V^-$  ( $V^+ = 2.5V$ )

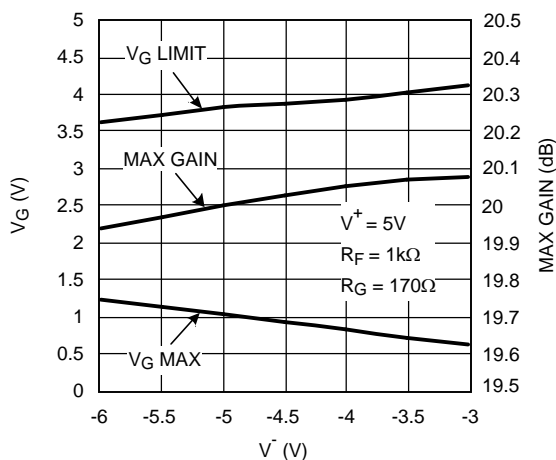
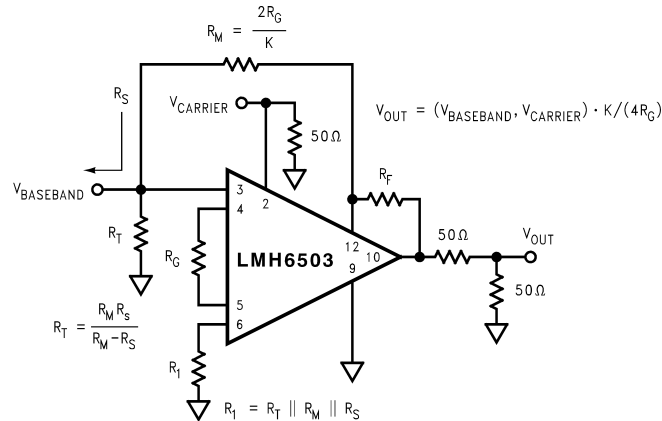

Figure 68.  $V_{G\_MAX}$ ,  $V_{G\_LIMIT}$ , & Max-gain vs.  $V^-$  ( $V^+ = 5V$ )

## Application Circuits

### FOUR-QUADRANT MULTIPLIER

Applications requiring multiplication, squaring or other non-linear functions can be implemented with four-quadrant multipliers. The LMH6503 implements a four-quadrant multiplier as illustrated in [Figure 69](#):



**Figure 69. Four Quadrant Multiplier**

### FREQUENCY SHAPING

Frequency shaping and bandwidth extension of the LMH6503 can be accomplished using parallel networks connected across the  $R_G$  ports. The network shown in the [Figure 70](#) schematic will effectively extend the LMH6503's bandwidth.

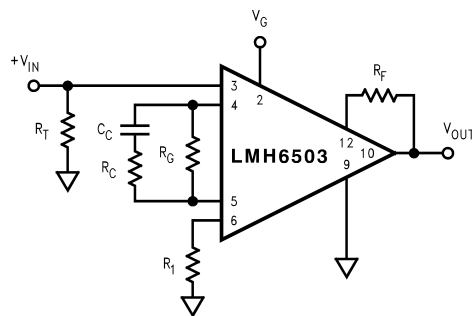
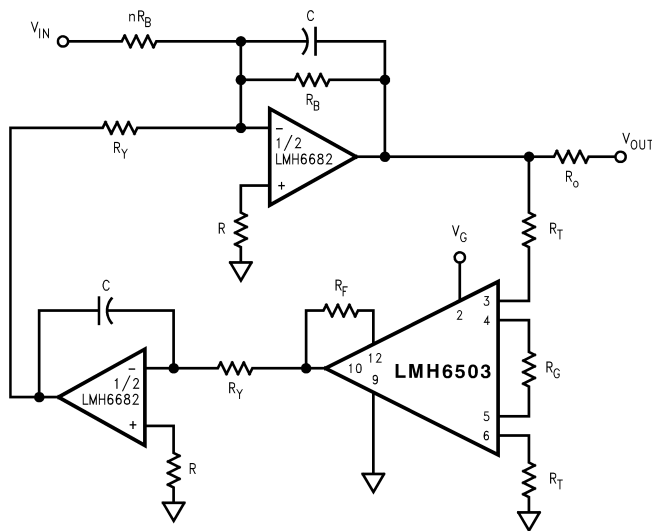

**Figure 70. Frequency Shaping**

### 2<sup>nd</sup> ORDER TUNABLE BANDPASS FILTER

The LMH6503 Variable-Gain Amplifier placed into a feedback loop provides signal processing function such as in a 2nd order tunable bandpass filter. The center frequency of the 2nd order bandpass shown in [Figure 71](#) is adjusted through the use of the LMH6503's gain control voltage,  $V_G$ . The integrators implemented with two sections of a LMH6682, provide the coefficients for the transfer function.





$$\frac{V_O}{V_{IN}} = \left[ -\frac{1}{n} \right] \frac{s \frac{1}{CR_B}}{s^2 + s \frac{1}{CR_B} + \frac{p}{C^2 R_Y^2}}$$

$$p = 1.72 \frac{R_F}{R_Y}, Q = \frac{\sqrt{pR_B}}{R_Y}, \omega_0 = \frac{\sqrt{p}}{CR_Y}$$

Figure 71. Tunable Bandpass Filter

## REVISION HISTORY

| Changes from Revision D (April 2013) to Revision E         | Page               |
|--|--------------------|
| • Changed layout of National Data Sheet to TI format ..... | <a href="#">25</a> |

**PACKAGING INFORMATION**

| Orderable Device | Status<br>(1) | Package Type | Package Drawing | Pins | Package Qty | Eco Plan<br>(2)         | Lead/Ball Finish<br>(6) | MSL Peak Temp<br>(3) | Op Temp (°C) | Device Marking<br>(4/5) | Samples                 |
|------------------|---------------|--------------|-----------------|------|-------------|-------------------------|-------------------------|----------------------|--------------|-------------------------|-------------------------|
| LMH6503MA/NOPB   | ACTIVE        | SOIC         | D               | 14   | 55          | Green (RoHS & no Sb/Br) | CU SN                   | Level-1-260C-UNLIM   | -40 to 85    | LMH6503MA               | <a href="#">Samples</a> |
| LMH6503MAX/NOPB  | ACTIVE        | SOIC         | D               | 14   | 2500        | Green (RoHS & no Sb/Br) | CU SN                   | Level-1-260C-UNLIM   | -40 to 85    | LMH6503MA               | <a href="#">Samples</a> |
| LMH6503MT        | NRND          | TSSOP        | PW              | 14   | 94          | TBD                     | Call TI                 | Call TI              | -40 to 85    | LMH6503MT               |                         |
| LMH6503MT/NOPB   | ACTIVE        | TSSOP        | PW              | 14   | 94          | Green (RoHS & no Sb/Br) | CU SN                   | Level-1-260C-UNLIM   | -40 to 85    | LMH6503MT               | <a href="#">Samples</a> |
| LMH6503MTX/NOPB  | ACTIVE        | TSSOP        | PW              | 14   | 2500        | Green (RoHS & no Sb/Br) | CU SN                   | Level-1-260C-UNLIM   | -40 to 85    | LMH6503MT               | <a href="#">Samples</a> |

(1) The marketing status values are defined as follows:

**ACTIVE:** Product device recommended for new designs.

**LIFEBUY:** TI has announced that the device will be discontinued, and a lifetime-buy period is in effect.

**NRND:** Not recommended for new designs. Device is in production to support existing customers, but TI does not recommend using this part in a new design.

**PREVIEW:** Device has been announced but is not in production. Samples may or may not be available.

**OBSOLETE:** TI has discontinued the production of the device.

(2) **RoHS:** TI defines "RoHS" to mean semiconductor products that are compliant with the current EU RoHS requirements for all 10 RoHS substances, including the requirement that RoHS substance do not exceed 0.1% by weight in homogeneous materials. Where designed to be soldered at high temperatures, "RoHS" products are suitable for use in specified lead-free processes. TI may reference these types of products as "Pb-Free".

**RoHS Exempt:** TI defines "RoHS Exempt" to mean products that contain lead but are compliant with EU RoHS pursuant to a specific EU RoHS exemption.

**Green:** TI defines "Green" to mean the content of Chlorine (Cl) and Bromine (Br) based flame retardants meet JS709B low halogen requirements of <=1000ppm threshold. Antimony trioxide based flame retardants must also meet the <=1000ppm threshold requirement.

(3) MSL, Peak Temp. - The Moisture Sensitivity Level rating according to the JEDEC industry standard classifications, and peak solder temperature.

(4) There may be additional marking, which relates to the logo, the lot trace code information, or the environmental category on the device.

(5) Multiple Device Markings will be inside parentheses. Only one Device Marking contained in parentheses and separated by a "-" will appear on a device. If a line is indented then it is a continuation of the previous line and the two combined represent the entire Device Marking for that device.

(6) Lead/Ball Finish - Orderable Devices may have multiple material finish options. Finish options are separated by a vertical ruled line. Lead/Ball Finish values may wrap to two lines if the finish value exceeds the maximum column width.

**Important Information and Disclaimer:** The information provided on this page represents TI's knowledge and belief as of the date that it is provided. TI bases its knowledge and belief on information provided by third parties, and makes no representation or warranty as to the accuracy of such information. Efforts are underway to better integrate information from third parties. TI has taken and continues to take reasonable steps to provide representative and accurate information but may not have conducted destructive testing or chemical analysis on incoming materials and chemicals. TI and TI suppliers consider certain information to be proprietary, and thus CAS numbers and other limited information may not be available for release.

In no event shall TI's liability arising out of such information exceed the total purchase price of the TI part(s) at issue in this document sold by TI to Customer on an annual basis.

## TAPE AND REEL INFORMATION



### QUADRANT ASSIGNMENTS FOR PIN 1 ORIENTATION IN TAPE



\*All dimensions are nominal

| Device          | Package Type | Package Drawing | Pins | SPQ  | Reel Diameter (mm) | Reel Width W1 (mm) | A0 (mm) | B0 (mm) | K0 (mm) | P1 (mm) | W (mm) | Pin1 Quadrant |
|-----------------|--------------|-----------------|------|------|--------------------|--------------------|---------|---------|---------|---------|--------|---------------|
| LMH6503MAX/NOPB | SOIC         | D               | 14   | 2500 | 330.0              | 16.4               | 6.5     | 9.35    | 2.3     | 8.0     | 16.0   | Q1            |
| LMH6503MTX/NOPB | TSSOP        | PW              | 14   | 2500 | 330.0              | 12.4               | 6.95    | 5.6     | 1.6     | 8.0     | 12.0   | Q1            |

**TAPE AND REEL BOX DIMENSIONS**

\*All dimensions are nominal



| Device          | Package Type | Package Drawing | Pins | SPQ  | Length (mm) | Width (mm) | Height (mm) |
|-----------------|--------------|-----------------|------|------|-------------|------------|-------------|
| LMH6503MAX/NOPB | SOIC         | D               | 14   | 2500 | 367.0       | 367.0      | 35.0        |
| LMH6503MTX/NOPB | TSSOP        | PW              | 14   | 2500 | 367.0       | 367.0      | 35.0        |

D (R-PDSO-G14)

PLASTIC SMALL OUTLINE



4040047-5/M 06/11

- NOTES:
- A. All linear dimensions are in inches (millimeters).
  - B. This drawing is subject to change without notice.
  -  Body length does not include mold flash, protrusions, or gate burrs. Mold flash, protrusions, or gate burrs shall not exceed 0.006 (0,15) each side.
  -  Body width does not include interlead flash. Interlead flash shall not exceed 0.017 (0,43) each side.
  - E. Reference JEDEC MS-012 variation AB.

D (R-PDSO-G14)

PLASTIC SMALL OUTLINE



- NOTES:
- A. All linear dimensions are in millimeters.
  - B. This drawing is subject to change without notice.
  - C. Publication IPC-7351 is recommended for alternate designs.
  - D. Laser cutting apertures with trapezoidal walls and also rounding corners will offer better paste release. Customers should contact their board assembly site for stencil design recommendations. Refer to IPC-7525 for other stencil recommendations.
  - E. Customers should contact their board fabrication site for solder mask tolerances between and around signal pads.



PW (R-PDSO-G14)

PLASTIC SMALL OUTLINE



- NOTES:
- A. All linear dimensions are in millimeters. Dimensioning and tolerancing per ASME Y14.5M-1994.
  - B. This drawing is subject to change without notice.
  - C. Body length does not include mold flash, protrusions, or gate burrs. Mold flash, protrusions, or gate burrs shall not exceed 0,15 each side.
  - D. Body width does not include interlead flash. Interlead flash shall not exceed 0,25 each side.
  - E. Falls within JEDEC MO-153

PW (R-PDSO-G14)

PLASTIC SMALL OUTLINE



- NOTES:
- All linear dimensions are in millimeters.
  - This drawing is subject to change without notice.
  - Publication IPC-7351 is recommended for alternate designs.
  - Laser cutting apertures with trapezoidal walls and also rounding corners will offer better paste release. Customers should contact their board assembly site for stencil design recommendations. Refer to IPC-7525 for other stencil recommendations.
  - Customers should contact their board fabrication site for solder mask tolerances between and around signal pads.

## IMPORTANT NOTICE AND DISCLAIMER

TI PROVIDES TECHNICAL AND RELIABILITY DATA (INCLUDING DATASHEETS), DESIGN RESOURCES (INCLUDING REFERENCE DESIGNS), APPLICATION OR OTHER DESIGN ADVICE, WEB TOOLS, SAFETY INFORMATION, AND OTHER RESOURCES "AS IS" AND WITH ALL FAULTS, AND DISCLAIMS ALL WARRANTIES, EXPRESS AND IMPLIED, INCLUDING WITHOUT LIMITATION ANY IMPLIED WARRANTIES OF MERCHANTABILITY, FITNESS FOR A PARTICULAR PURPOSE OR NON-INFRINGEMENT OF THIRD PARTY INTELLECTUAL PROPERTY RIGHTS.

These resources are intended for skilled developers designing with TI products. You are solely responsible for (1) selecting the appropriate TI products for your application, (2) designing, validating and testing your application, and (3) ensuring your application meets applicable standards, and any other safety, security, or other requirements. These resources are subject to change without notice. TI grants you permission to use these resources only for development of an application that uses the TI products described in the resource. Other reproduction and display of these resources is prohibited. No license is granted to any other TI intellectual property right or to any third party intellectual property right. TI disclaims responsibility for, and you will fully indemnify TI and its representatives against, any claims, damages, costs, losses, and liabilities arising out of your use of these resources.

TI's products are provided subject to TI's Terms of Sale ([www.ti.com/legal/termsofsale.html](http://www.ti.com/legal/termsofsale.html)) or other applicable terms available either on [ti.com](http://ti.com) or provided in conjunction with such TI products. TI's provision of these resources does not expand or otherwise alter TI's applicable warranties or warranty disclaimers for TI products.

Mailing Address: Texas Instruments, Post Office Box 655303, Dallas, Texas 75265  
Copyright © 2019, Texas Instruments Incorporated