

High Voltage MOSFET

N-Channel, Depletion Mode

IXTH 20N50D
IXTT 20N50D

$$V_{DSS} = 500 \text{ V}$$

$$I_{D25} = 20 \text{ A}$$

$$R_{DS(on)} = 0.33 \text{ } \Omega$$

Preliminary Data Sheet

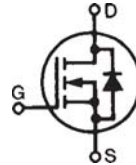

| Symbol | Test Conditions | Maximum Ratings | |
|------------|--|-----------------|------------------|
| V_{DSX} | $T_J = 25^\circ\text{C}$ to 150°C | 500 | V |
| V_{DGX} | $T_J = 25^\circ\text{C}$ to 150°C | 500 | V |
| V_{GS} | Continuous | ± 30 | V |
| V_{GSM} | Transient | ± 40 | V |
| I_{D25} | $T_C = 25^\circ\text{C}$ | 20 | A |
| I_{DM} | $T_C = 25^\circ\text{C}$; pulse width limited by T_{JM} | 50 | A |
| P_D | $T_C = 25^\circ\text{C}$ | 400 | W |
| T_J | | -55 ... + 150 | $^\circ\text{C}$ |
| T_{JM} | | 150 | $^\circ\text{C}$ |
| T_{stg} | | -55 ... + 150 | $^\circ\text{C}$ |
| T_L | 1.6 mm (0.063 in) from case for 10 seconds | 300 | $^\circ\text{C}$ |
| T_{ISOL} | Plastic case for 10 seconds | 300 | $^\circ\text{C}$ |
| M_d | Mounting torque | 1.13/10 | Nm/lb.in. |
| Weight | TO-247 | 6 | g |
| | TO-268 | 4 | g |

TO-247 (IXFH)

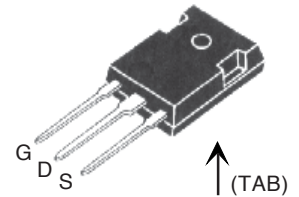

TO-268 (IXTT)

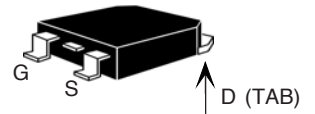

G = Gate D = Drain
S = Source TAB = Drain

Features

- Normally ON Mode
- International standard packages
- Molding epoxies meet UL94 V-0 flammability classification

Applications

- Level shifting
- Triggers
- Solid State Relays
- Current Regulators
- Active load

| Symbol | Test Conditions | Characteristic Values ($T_J = 25^\circ\text{C}$, unless otherwise specified) | | |
|----------------|---|---|------|----------------------|
| | | min. | typ. | max. |
| V_{DSX} | $V_{GS} = -10 \text{ V}$, $I_D = 250 \text{ mA}$ | 500 | | V |
| $V_{GS(off)}$ | $V_{DS} = 25 \text{ V}$, $I_D = 250 \text{ mA}$ | -1.5 | | V |
| I_{GSS} | $V_{GS} = \pm 30 \text{ V}_{DC}$, $V_{DS} = 0$ | | | $\pm 100 \text{ nA}$ |
| $I_{DSX(off)}$ | $V_{DS} = V_{DSS}$ $V_{GS} = -10 \text{ V}$ | $T_J = 25^\circ\text{C}$ $T_J = 125^\circ\text{C}$ | | 25 μA |
| | | | | 500 μA |
| $R_{DS(on)}$ | $V_{GS} = 10 \text{ V}$, $I_D = 10 \text{ A}$ Note 1 | | | 0.33 Ω |
| $I_{D(on)}$ | $V_{GS} = 0 \text{ V}$, $V_{DS} = 25 \text{ V}$ Note 1 | | 1.5 | A |

| Symbol | Test Conditions | Characteristic Values | | |
|--------------|--|--|------|------|
| | | $(T_J = 25^\circ\text{C}, \text{ unless otherwise specified})$ | | |
| | | min. | typ. | max. |
| g_{fs} | $V_{DS} = 30\text{ V}, I_D = 10\text{ A}, \text{ Note 1}$ | 4.0 | 7.5 | S |
| C_{iss} | $V_{GS} = -10\text{ V}, V_{DS} = 25\text{ V}, f = 1\text{ MHz}$ | | 2500 | pF |
| C_{oss} | | | 400 | pF |
| C_{rss} | | | 100 | pF |
| $t_{d(on)}$ | $V_{GS} = 0\text{ V to } -10\text{ V}, V_{DS} = 0.5 \cdot V_{DSX}$ $I_D = 10\text{ A}, R_G = 4.7\ \Omega \text{ (External)},$ | | 35 | ns |
| t_r | | | 85 | ns |
| $t_{d(off)}$ | | | 110 | ns |
| t_f | | | 75 | ns |
| $Q_{g(on)}$ | $V_{GS} = 10\text{ V}, V_{DS} = 0.5 \cdot V_{DSX}, I_D = 0.5 \cdot I_{D25}$ | | 125 | nC |
| Q_{gs} | | | 35 | nC |
| Q_{gd} | | | 51 | nC |
| R_{thJC} | | | 0.31 | K/W |
| R_{thCK} | | | 0.25 | K/W |

Source-Drain Diode

| Symbol | Test Conditions | Characteristic Values | | |
|----------|---|--|------|------|
| | | $(T_J = 25^\circ\text{C}, \text{ unless otherwise specified})$ | | |
| | | min. | typ. | max. |
| V_{SD} | $I_F = I_{D25}, V_{GS} = -10\text{ V}, \text{ Note 1}$ | 0.85 | 1.5 | V |
| t_{rr} | $I_F = 20\text{ A}, -di/dt = 100\text{ A}/\mu\text{s}, V_R = 100\text{ V}$ $V_{GS} = -10\text{ V}$ | | 510 | ns |

Note 1: Pulse test, $t \leq 300\ \mu\text{s}$, duty cycle $d \leq 2\%$

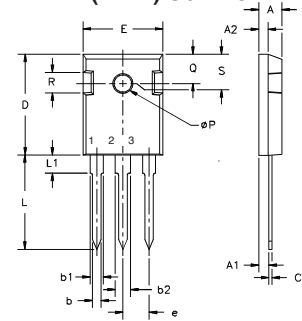
TO-247 AD (IXTH) Outline

Terminals:
 1 - Gate 2 - Drain
 3 - Source Tab - Drain

| Dim. | Millimeter | | Inches | |
|----------------|------------|-------|--------|-------|
| | Min. | Max. | Min. | Max. |
| A | 4.7 | 5.3 | .185 | .209 |
| A ₁ | 2.2 | 2.54 | .087 | .102 |
| A ₂ | 2.2 | 2.6 | .059 | .098 |
| b | 1.0 | 1.4 | .040 | .055 |
| b ₁ | 1.65 | 2.13 | .065 | .084 |
| b ₂ | 2.87 | 3.12 | .113 | .123 |
| C | .4 | .8 | .016 | .031 |
| D | 20.80 | 21.46 | .819 | .845 |
| E | 15.75 | 16.26 | .610 | .640 |
| e | 5.20 | 5.72 | 0.205 | 0.225 |
| L | 19.81 | 20.32 | .780 | .800 |
| L ₁ | | 4.50 | | .177 |
| ∅P | 3.55 | 3.65 | .140 | .144 |
| Q | 5.89 | 6.40 | 0.232 | 0.252 |
| R | 4.32 | 5.49 | .170 | .216 |
| S | 6.15 | BSC | .242 | BSC |

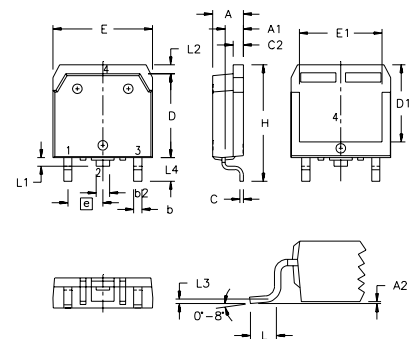
TO-268 (IXTTH) Outline

Terminals:
 1 - Gate 2 - Drain
 3 - Source Tab - Drain

| SYM | INCHES | | MILLIMETERS | |
|----------------|--------|------|-------------|-------|
| | MIN | MAX | MIN | MAX |
| A | .193 | .201 | 4.90 | 5.10 |
| A ₁ | .106 | .114 | 2.70 | 2.90 |
| A ₂ | .001 | .010 | 0.02 | 0.25 |
| b | .045 | .057 | 1.15 | 1.45 |
| b ₂ | .075 | .083 | 1.90 | 2.10 |
| C | .016 | .026 | 0.40 | 0.65 |
| C ₂ | .057 | .063 | 1.45 | 1.60 |
| D | .543 | .551 | 13.80 | 14.00 |
| D ₁ | .488 | .500 | 12.40 | 12.70 |
| E | .624 | .632 | 15.85 | 16.05 |
| E ₁ | .524 | .535 | 13.30 | 13.60 |
| e | .215 | BSC | 5.45 | BSC |
| H | .736 | .752 | 18.70 | 19.10 |
| L | .094 | .106 | 2.40 | 2.70 |
| L ₁ | .047 | .055 | 1.20 | 1.40 |
| L ₂ | .039 | .045 | 1.00 | 1.15 |
| L ₃ | .010 | BSC | 0.25 | BSC |
| L ₄ | .150 | .161 | 3.80 | 4.10 |

IXYS reserves the right to change limits, test conditions, and dimensions.

| | | | | | | | | |
|--|-----------|-----------|-----------|-----------|--------------|--------------|--------------|-----------|
| IXYS MOSFETs and IGBTs are covered by one or more of the following U.S. patents: | 4,835,592 | 4,931,844 | 5,049,961 | 5,237,481 | 6,162,665 | 6,404,065 B1 | 6,683,344 | 6,727,585 |
| | 4,850,072 | 5,017,508 | 5,063,307 | 5,381,025 | 6,259,123 B1 | 6,534,343 | 6,710,405 B2 | |
| | 4,881,106 | 5,034,796 | 5,187,117 | 5,486,715 | 6,306,728 B1 | 6,583,505 | 6,710,463 | |

**Fig. 1. Output Characteristics
@ 25°C**

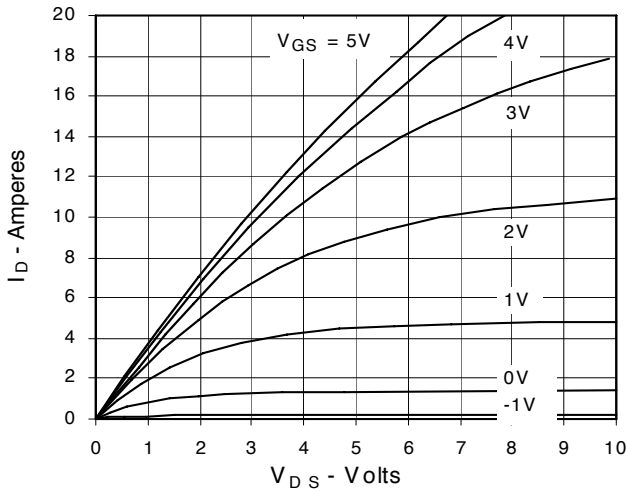

**Fig. 3. Output Characteristics
@ 125°C**

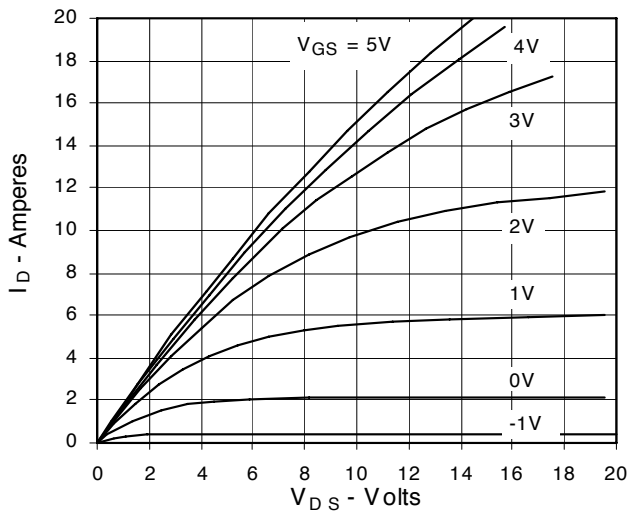

**Fig. 5. $R_{DS(on)}$ Normalized to
0.5 I_{D25} Value vs. I_D**

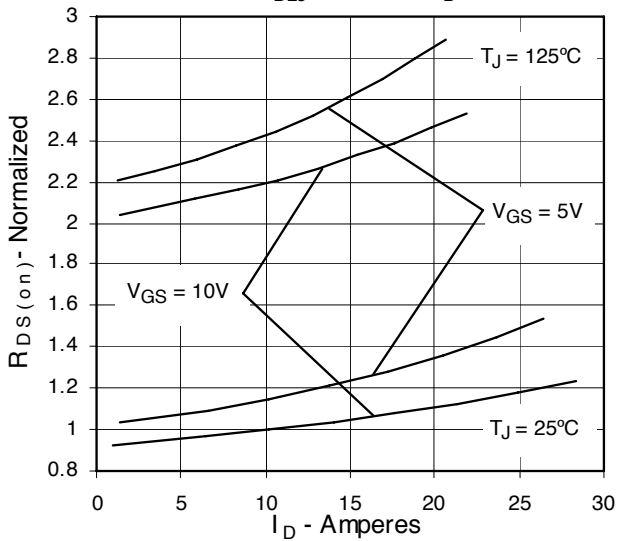

**Fig. 2. Extended Output Characteristics
@ 25°C**

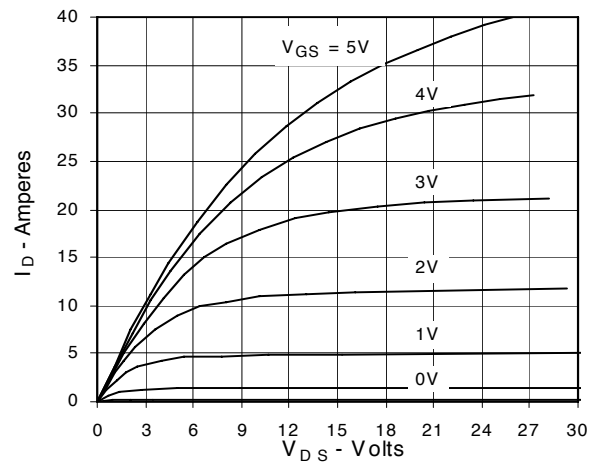

**Fig. 4. $R_{DS(on)}$ Normalized to 0.5 I_{D25}
Value vs. Junction Temperature**

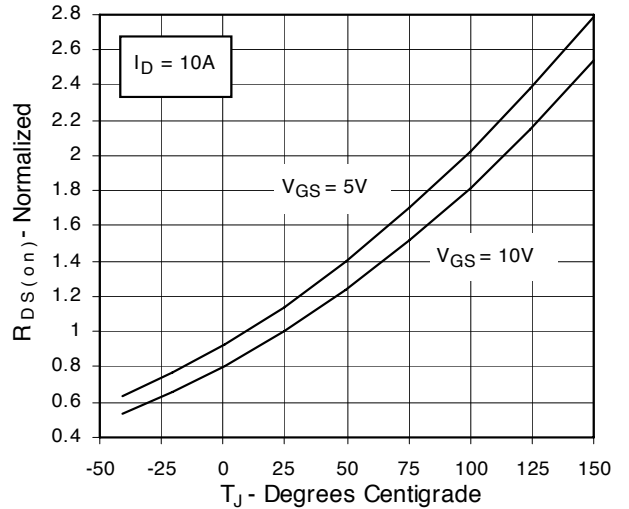

**Fig. 6. Drain Current vs. Case
Temperature**

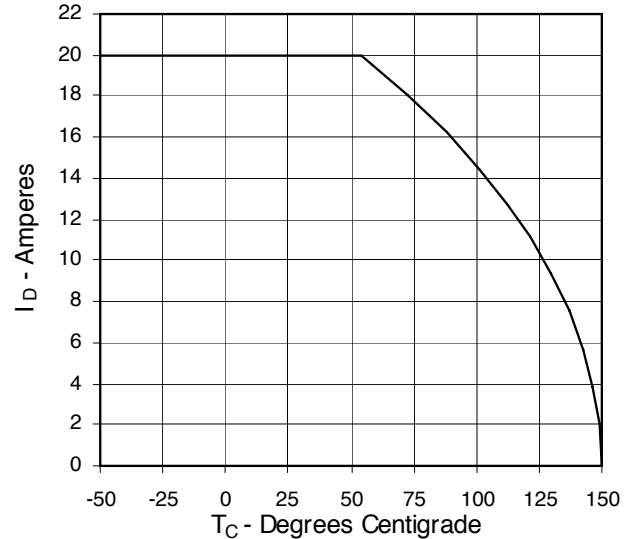

Fig. 7. Input Admittance

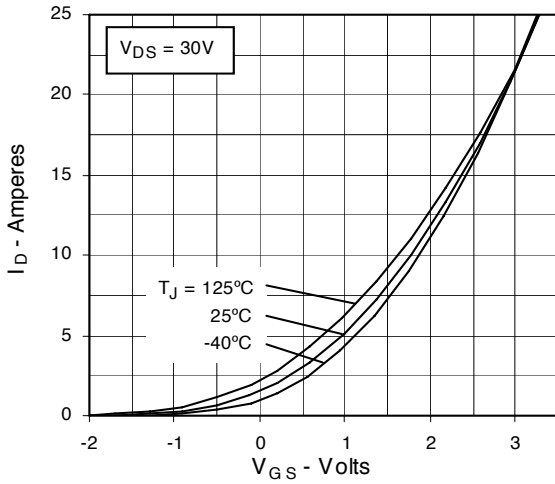

Fig. 8. Transconductance

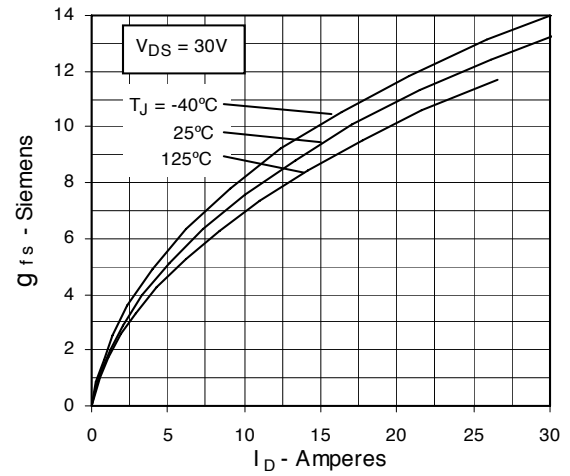

Fig. 9. Source Current vs. Source-To-Drain Voltage

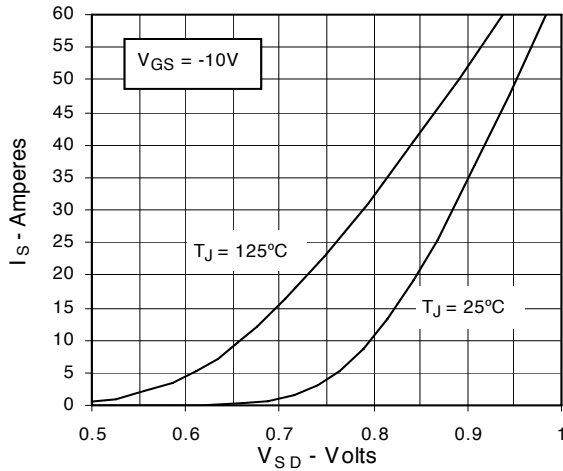

Fig. 10. Dependence of Breakdown and Threshold Voltages on Temperature

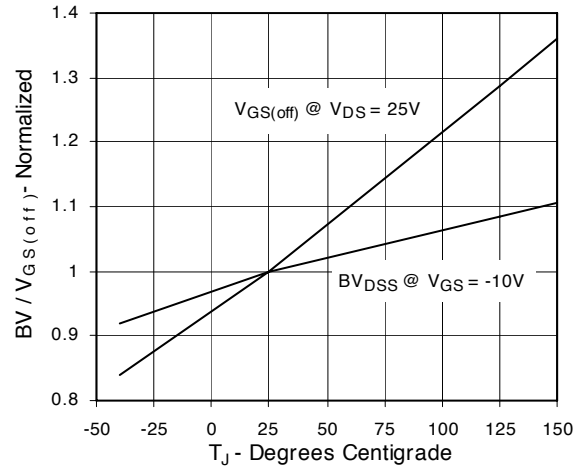

Fig. 11. Gate Charge

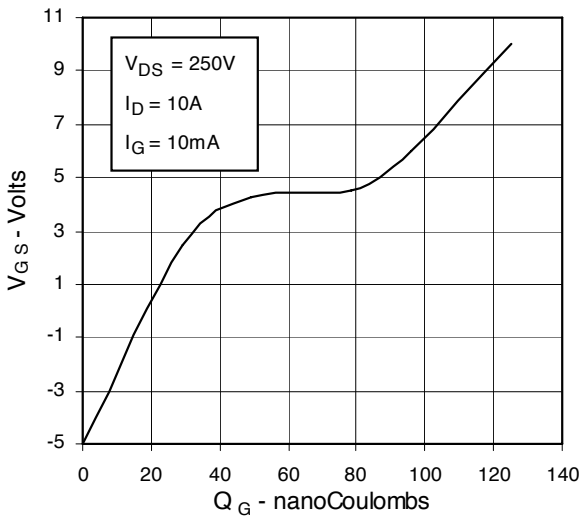
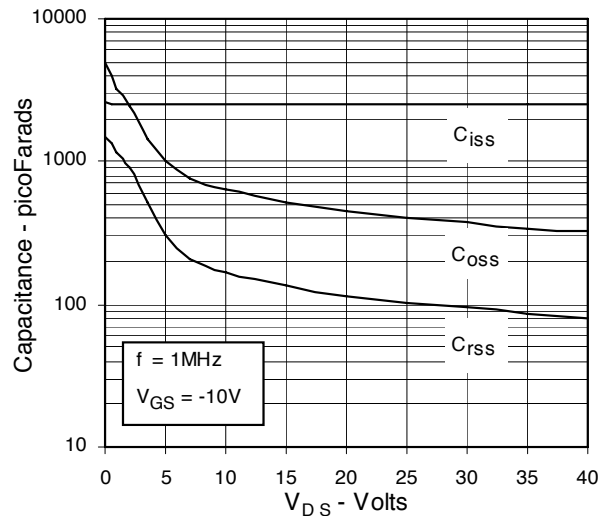

Fig. 12. Capacitance



**Fig. 13. Forward-Bias
Safe Operating Area**

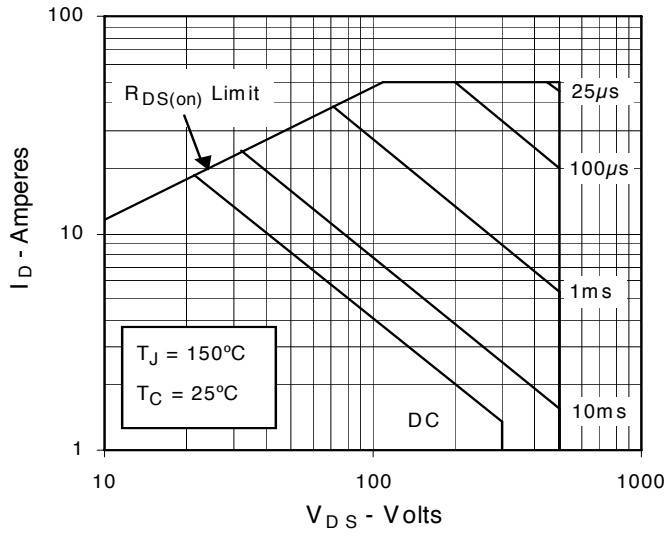
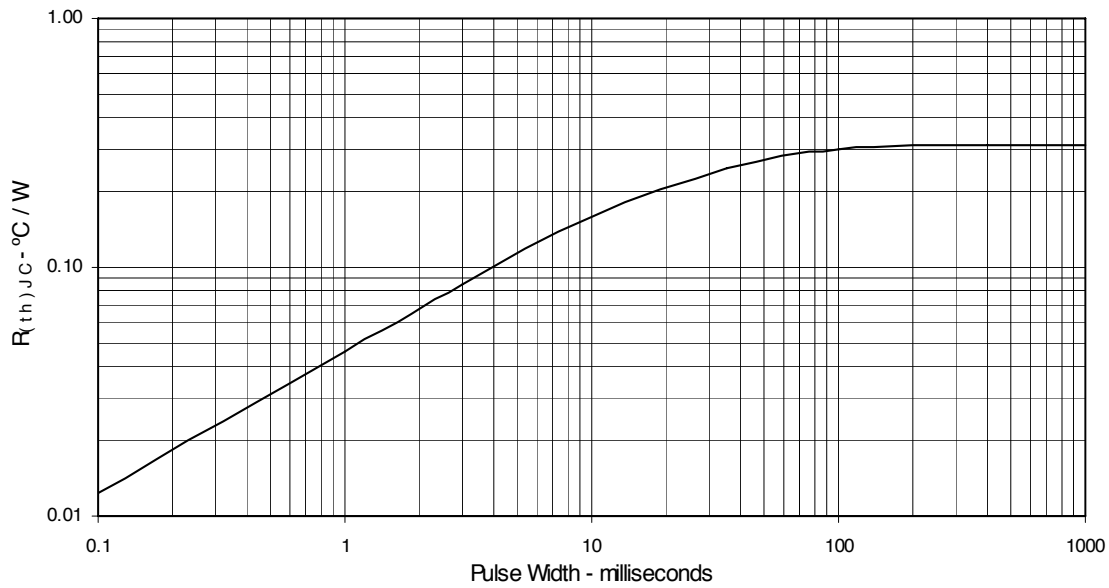

Fig. 14. Maximum Transient Thermal Resistance



Mouser Electronics

Authorized Distributor

Click to View Pricing, Inventory, Delivery & Lifecycle Information:

[IXYS:](#)

[IXTH20N50D](#)