

## 300mW, NPN Small Signal Transistor

### FEATURES

- Low power loss, high efficiency
- Ideal for automated placement
- High surge current capability
- Compliant to RoHS directive 2011/65/EU and in accordance to WEEE 2002/96/EC
- Halogen-free according to IEC 61249-2-21

### APPLICATIONS

- Switching mode power supply (SMPS)
- Adapters
- Lighting application
- On-board DC/DC converter

### MECHANICAL DATA

- Case: SOT-23
- Molding compound: UL flammability classification rating 94V-0
- Moisture sensitivity level: level 1, per J-STD-020
- Packing code with suffix "G" means green compound (halogen-free)
- Matte tin plated leads, solderable per J-STD-002
- Meet JESD 201 class 1A whisker test
- Polarity: Indicated by cathode band
- Weight: 8 mg (approximately)

KEY PARAMETERS		
PARAMETER	VALUE	UNIT
$V_{CBO}$	75	V
$V_{CEO}$	40	V
$V_{EBO}$	6	V
$I_C$	600	mA
$h_{FE}$	300	
Package	SOT-23	
Configuration	Single Dice	

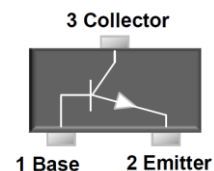

ABSOLUTE MAXIMUM RATINGS ( $T_A = 25^\circ\text{C}$ unless otherwise noted)			
PARAMETER	SYMBOL	MMBT2222A	UNIT
Marking code on the device		1P	
Collector-base voltage, emitter open	$V_{CBO}$	75	V
Collector-emitter voltage, base open	$V_{CEO}$	40	V
Emitter-base voltage, collector open	$V_{EBO}$	6	V
Collector current, dc	$I_C$	600	mA
Total dc power input to all terminals	$P_T$	300	mW
Junction temperature	$T_J$	-55 to +150	$^\circ\text{C}$
Storage temperature	$T_{STG}$	-55 to +150	$^\circ\text{C}$

<b>ELECTRICAL SPECIFICATIONS</b> ( $T_A = 25^\circ\text{C}$ unless otherwise noted)						
<b>PARAMETER</b>	<b>CONDITIONS</b>	<b>SYMBOL</b>	<b>MIN</b>	<b>TYP</b>	<b>MAX</b>	<b>UNIT</b>
Collector-base breakdown voltage, emitter open	$I_C = 10\ \mu\text{A}, I_E = 0$	$V_{(BR)CBO}$	75	-	-	V
Collector-emitter breakdown voltage, base open	$I_C = 10\ \text{mA}, I_B = 0$	$V_{(BR)CEO}$	40	-	-	V
Emitter-base breakdown voltage, collector open	$I_E = 10\ \mu\text{A}, I_C = 0$	$V_{(BR)EBO}$	6	-	-	V
Collector cutoff current, emitter open	$V_{CB} = 60\ \text{V}, I_E = 0$	$I_{CBO}$	-	-	0.01	$\mu\text{A}$
Emitter cutoff current, collector open	$V_{EB} = 3\ \text{V}, I_C = 0$	$I_{EBO}$	-	-	0.1	$\mu\text{A}$
DC Current Gain	$V_{CE} = 10\ \text{V}, I_C = 500\ \text{mA}$	$h_{FE}$	40	-	-	
	$V_{CE} = 10\ \text{V}, I_C = 150\ \text{mA}$		100	-	300	
	$V_{CE} = 10\ \text{V}, I_C = 10\ \text{mA}$		75	-	-	
	$V_{CE} = 10\ \text{V}, I_C = 1\ \text{mA}$		50	-	-	
	$V_{CE} = 10\ \text{V}, I_C = 0.1\ \text{mA}$		35	-	-	
Collector-emitter saturation voltage	$I_C = 500\ \text{mA}, I_B = 50\ \text{mA}$	$V_{CE(sat)}$	-	-	1	V
Base-emitter saturation voltage	$I_C = 500\ \text{mA}, I_B = 50\ \text{mA}$	$V_{BE(sat)}$	-	-	2	V
Transition frequency	$V_{CE} = 20\ \text{V}, I_C = 20\ \text{mA}, f = 100\ \text{MHz}$	$f_T$	300	-	-	MHz
Output Capacitance	1 MHz, $V_{CB} = 10\ \text{V}, I_E = 0$	$C_{OBO}$	8			pF
Input Capacitance	1 MHz, $V_{EB} = 0.5\ \text{V}, I_C = 0$	$C_{IBO}$	25			pF
Delay Time	$V_{CC} = 30\ \text{V}, V_{BE(off)} = -0.5\ \text{V}, I_C = 150\ \text{mA}$	$t_d$	-	-	10	ns
Rise Time	$I_{B1} = 15\ \text{mA}$	$t_r$	-	-	25	ns
Storage Time	$V_{CC} = 30\ \text{V}, I_{B1} = -I_{B2} = 15\ \text{mA}, I_C = 150\ \text{mA}$	$t_s$	-	-	225	ns
Fall Time	$V_{CC} = 30\ \text{V}, I_{B1} = -I_{B2} = 15\ \text{mA}, I_C = 150\ \text{mA}$	$t_f$	-	-	60	ns

**ORDERING INFORMATION**

<b>PART NO.</b>	<b>PACKING CODE</b>	<b>PACKING CODE SUFFIX</b>	<b>PACKAGE</b>	<b>PACKING</b>
MMBT2222A (Note 1)	RF	G	SOT-23	3K / 7" Reel

**Notes:**

1. Whole series with green compound

**EXAMPLE**

<b>EXAMPLE P/N</b>	<b>PART NO.</b>	<b>PACKING CODE</b>	<b>PACKING CODE SUFFIX</b>	<b>DESCRIPTION</b>
MMBT2222A RFG	MMBT2222A	RF	G	Green compound

**CHARACTERISTICS CURVES**

( $T_A = 25^\circ\text{C}$  unless otherwise noted)

**Fig. 1 Max Power Dissipation VS. Ambient Temperature**

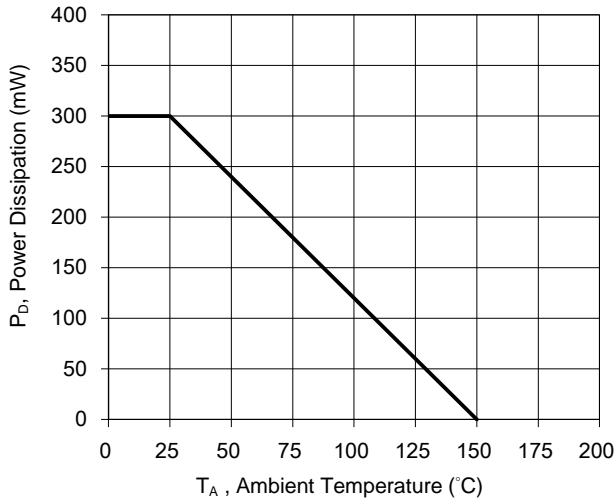

**Fig.2 Typical Capacitance**

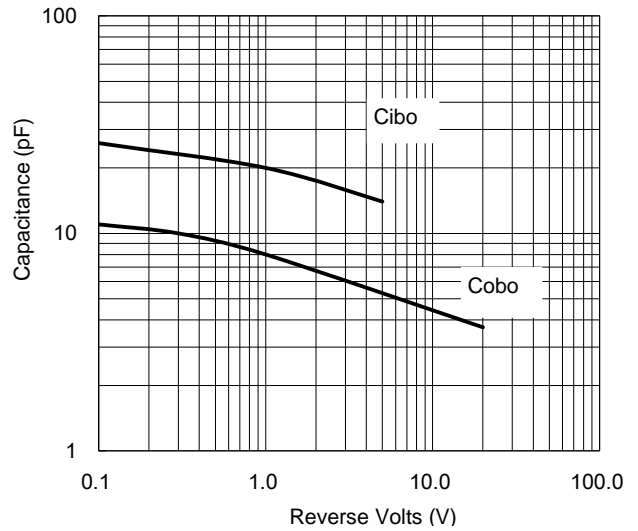

**Fig.3 Typical DC Current Gain VS. Collector Current**

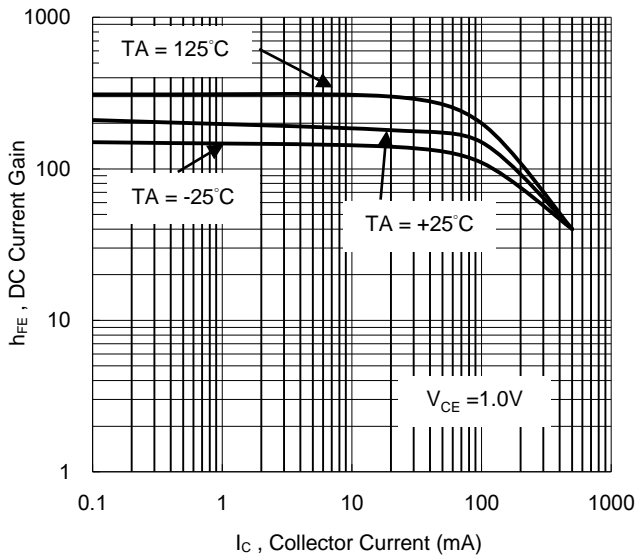

**Fig.4 Gain Bandwidth Product VS. Collector Current**

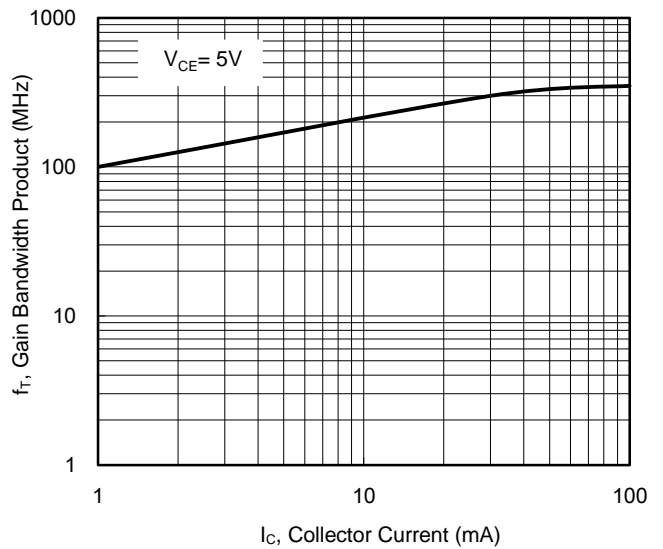

**CHARACTERISTICS CURVES**

( $T_A = 25^\circ\text{C}$  unless otherwise noted)

**Fig.5 Collector Emitter Saturation Voltage VS. Collector Current**

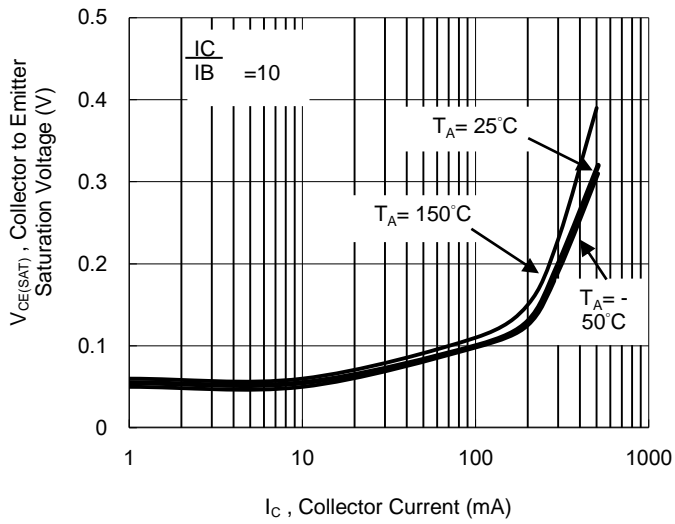

**Fig.6 Base Emitter Voltage vs. Collector Current**

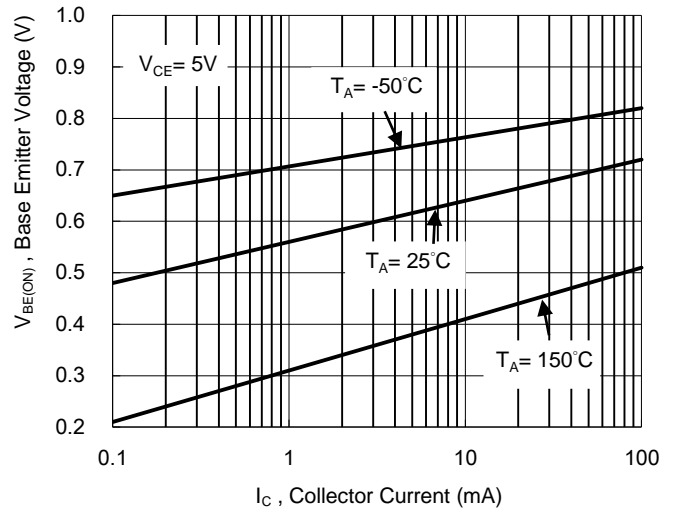

**PACKAGE OUTLINE DIMENSION**

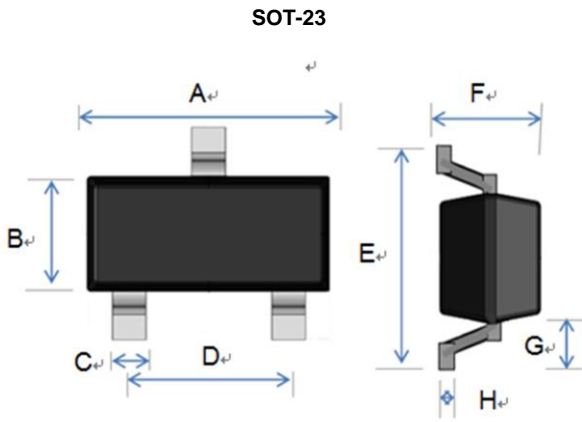

DIM.	Unit(mm)		Unit(inch)	
	Min	Max	Min	Max
A	2.70	3.10	0.106	0.122
B	1.10	1.50	0.043	0.059
C	0.30	0.51	0.012	0.020
D	1.78	2.04	0.070	0.080
E	2.10	2.64	0.083	0.104
F	0.89	1.30	0.035	0.051
G	0.55 REF		0.022 REF	
H	0.10 REF		0.004 REF	

**SUGGEST PAD LAYOUT**

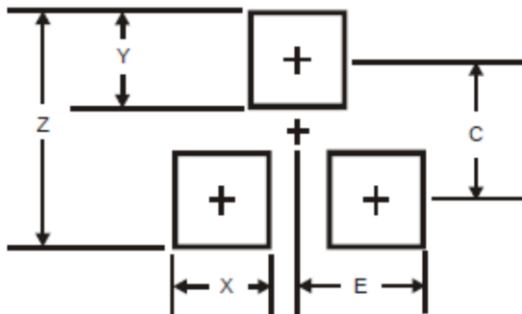

DIM.	Unit(mm)	Unit(inch)
	TYP	TYP
Z	2.8	0.11
X	0.7	0.03
Y	0.9	0.04
C	1.9	0.07
E	1.0	0.04

## Notice

Specifications of the products displayed herein are subject to change without notice. TSC or anyone on its behalf, assumes no responsibility or liability for any errors or inaccuracies.

Information contained herein is intended to provide a product description only. No license, express or implied, to any intellectual property rights is granted by this document. Except as provided in TSC's terms and conditions of sale for such products, TSC assumes no liability whatsoever, and disclaims any express or implied warranty, relating to sale and/or use of TSC products including liability or warranties relating to fitness for a particular purpose, merchantability, or infringement of any patent, copyright, or other intellectual property right.

The products shown herein are not designed for use in medical, life-saving, or life-sustaining applications. Customers using or selling these products for use in such applications do so at their own risk and agree to fully indemnify TSC for any damages resulting from such improper use or sale.

# Mouser Electronics

Authorized Distributor

Click to View Pricing, Inventory, Delivery & Lifecycle Information:

[Taiwan Semiconductor:](#)

[MMBT2222A](#) [MMBT2222A RF](#) [MMBT2222A RFG](#)