



**Restriction on the use of  
Hazardous Substances  
(RoHS)**

At Tyco Electronics, we're ready to support your RoHS requirements. We've assessed more than 1.5 million end items/components for RoHS compliance, and issued new part numbers where any change was required to eliminate the restricted materials.

Part numbers in this catalog are RoHS Compliant, unless marked otherwise. These products comply with European Union Directive 2002/95/EC, as amended 1 January 2006, that restricts the use of lead, mercury, cadmium, hexavalent chromium, PBB, and PBDE in certain electrical and electronic products sold into the EU as of 1 July 2006.

Note: For purposes of this Catalog, included within the definition of RoHS Compliant are products that are clearly "Out of Scope" of the RoHS Directive such as hand tools and other non-electrical accessories. Information regarding RoHS compliance is provided based on reasonable inquiry of our suppliers and represents our current actual knowledge based on the information provided by our suppliers. This information is subject to change. For latest compliance status, refer to our website referenced at right.

**Getting the Information  
You Need**

Our comprehensive on-line RoHS Customer Support Center provides a forum to answer your questions and support your RoHS needs. A RoHS FAQ (Frequently Asked Questions) is available with links to more detailed information. You can also submit RoHS questions and receive a response within 24 hours during a normal work week. The Support Center also provides:

- Cross-Reference from Non-compliant to Compliant Products
- Ability to browse RoHS Compliant Products in our on-line catalog
- Downloadable Technical Data
- Customer Information Presentation
- More detailed information regarding the definitions used above

So whatever your questions when it comes to RoHS, we have the answers at [www.tycoelectronics.com/leadfree](http://www.tycoelectronics.com/leadfree)

RoHS  
Customer  
Support  
Center 

Table of Contents

Introduction

AMP Soft Shell Pin and Socket Connectors provide a highly reliable and economic means of grouping multiple-lead connections in today's computer, computer/peripheral equipment, business machines, entertainment centers, appliances and other sophisticated commercial equipment. The electrical connector is an integral component in these applications. They also offer worldwide application approval because of their reliability and economy. Electrical functions have increased in complexity and new designs continually call for the maximum use of space. The Soft Shell Pin and Socket family of connectors offers the design and features to answer these modern industry requirements.

This catalog is organized by contact centerline spacing (High Density and Standard Density) to provide you with the basic information necessary to select the Soft Shell connector system best suited for your specific application. It contains general information to acquaint you with the complete family of connectors and application tooling.

Since your specific application will determine the degree of automatic, semiautomatic or manual application tooling required, complete specifications are covered on pages 207-204.

Summary Chart

| Page No.                | Product Name                       | No. of Positions       | Centerline (in) mm  | Wire Size (AWG) | Wire Insulation Dia. Max. (in) mm | Current Rating Max (A)* | Voltage Rating Max.   | Operating Temp. Range (C) | UL94 Flammability Rating | Sealed Version Available | Approvals   |
|-------------------------|------------------------------------|------------------------|---|-----------------|-----------------------------------|-------------------------|---|---------------------------|--------------------------|--------------------------|---|
| <b>High Density</b>     |                                    |                        |   |                 |                                   |                         |   |                           |                          |                          |   |
| 9                       | 2.5 mm Signal Double Lock (SDL)    | 2-13                   | (.098) 2.50   | 26-20           | (.071) 1.80                       | 3                       | 50 VAC or VDC   | -30° to +105°             | V-0                      | No                       | UL, CSA, VDE  |
| 17                      | Micro MATE-N-LOK 3 mm              | 2-24                   | (.118) 3.00   | 30-20           | (.060) 1.52                       | 5                       | 250 VAC   | -40° to +105°             | V-0                      | No                       | UL, CSA, VDE  |
| 49                      | Grace Inertia Connectors (GIC) 3.5 | 2-6                    | (.137) 3.50   | 26-18           | (.106) 2.70                       | 7                       | 300 VAC   | -30° to +105°             | V-0                      | No                       | UL, CSA   |
| 53                      | .062 Commercial Pin & Socket       | 1-9                    | (.145) 3.68   | 30-18           | (.110) 2.79                       | 7                       | 250 VAC or VDC  | -55° to +105°             | V-2                      | No                       | UL, CSA   |
| 59                      | Power Double Lock (PDL)            | 1-12<br>3-12<br>2<br>2 | (.156) 3.96<br>(.256) 6.50<br>(.312) 7.92<br>(.512) 13.00 | 26-16           | (.122) 3.10                       | 14                      | 300 VAC (3.96 WTW,<br>6.5 WTB and<br>7.92 WTB)<br>50 VAC (3.96 WTB) | -30° to +105°             | V-0                      | No                       | UL, CSA, VDE  |
| 83                      | Mini-Universal MATE-N-LOK          | 1-24                   | (.163) 4.14   | 30-16           | (.126) 3.20                       | 9.5                     | 600 VAC or VDC  | -55° to +105°             | V-0 & V-2                | Yes                      | UL, CSA,<br>VDE (250 V Max.)  |
| 99                      | Mini-Universal MATE-N-LOK 2        | 2-24                   | (.163) 4.14   | 30-16           | (.126) 3.20                       | 10.5                    | 600 VAC or VDC  | -55° to +105°             | V-0 & V-2                | No                       | UL, CSA, VDE  |
| 109                     | MR (Miniature Rectangular)         | 2-36                   | (.165) 4.20   | 26-18           | (.115) 2.92                       | 9                       | 250 VAC   | -55° to +85°              | V-0                      | No                       | UL, CSA   |
| 119                     | VAL-U-LOK Connector System         | 2-24                   | (.165) 4.20   | 26-18           | (.094) 2.39                       | 9                       | 600 VAC   | -40° to +105°             | V-0 & V-2                | No                       | UL, CSA   |
| 125                     | AMP-DUAC                           | 2-24                   | (.165) 4.20   | 26-18           | (.130) 3.30                       | 9                       | 600 VAC   | -55° to +105°             | V-2                      | No                       | UL, CSA   |
| <b>Standard Density</b> |                                    |                        |   |                 |                                   |                         |   |                           |                          |                          |   |
| 135                     | 5.0 mm Power Key Connectors (PKC)  | 2-6                    | (.197) 5.00   | 24-16           | (.122) 3.10                       | 10                      | 300 VAC   | -30° to +105°             | V-0                      | No                       | UL, CSA   |
| 143                     | .093 Commercial Pin & Socket       | 1-15                   | (.198) 5.03   | 14-24           | (.180) 4.57                       | 13                      | 250 VAC or VDC  | -55° to +105°             | V-2                      | No                       | UL, CSA   |
| 151                     | Commercial MATE-N-LOK              | 1-16                   | (.200) 5.08   | 30-14           | (.130) 3.30                       | 19                      | 250 VAC   | -55° to +105°             | V-2                      | No                       | UL, CSA   |
| 165                     | .140 MATE-N-LOK                    | 2-9                    | (.240) 6.10   | 20-10           | (.180) 4.57                       | 28                      | 600 VAC or VDC  | -55° to +105°             | V-2                      | No                       | UL, CSA   |
| 169                     | Universal MATE-N-LOK               | 1-15                   | (.250) 6.35   | 30-10           | (.200) 5.08                       | 19                      | 600 VAC or VDC  | -55° to +105°**           | V-0 & V-2                | Yes                      | UL, CSA, designed and tested to meet VDE 380 V requirements, except 6 Position Circular |
| 189                     | Universal MATE-N-LOK II            | 2-15                   | (.250) 6.35   | 30-10           | (.200) 5.08                       | 19                      | 600 VAC or VDC  | -55° to +105°             | V-0                      | No                       | UL, CSA, VDE  |
| 203                     | .156 MATE-N-LOK                    | 3-4                    | (.390) 9.91   | 20-10           | (.185) 4.70                       | 32.5                    | 600 VAC   | -55° to +105°             | V-2                      | No                       | UL  |

\*Current Rating is application dependent  
\*\* 125°C Available

**Table of Contents** (Continued)

**High Density**

**Need more information?**

Call Technical Support at a local number listed on the inside back cover.

Technical Support is staffed with specialists well versed in Tyco Electronics products.



**2.5 mm Signal Double Lock (2.5 SDL) Connectors .....9-16**  
 Product Facts .....9  
 Performance Characteristics .....9  
 Quick Reference Chart for Mating Part Numbers and Future Product Plans .....10  
 Mating Configurations (Wire-To-Wire and Wire-To-Board) .....11  
 Contacts and Double Lock Plates .....12  
 Plug Housings .....13  
 Cap Housings .....14  
 Headers, PC Board, Vertical: Standard-Profile .....15  
 High-Profile .....16



**Micro MATE-N-LOK 3 mm Connector System .....17-47**  
 Product Facts .....17  
 Performance Characteristics .....17-18  
 Connector Application .....19-21  
 Contacts .....22  
 Receptacle Housings .....23-24  
 Plug Housings .....25-28  
 Low Profile .....29  
 Vertical Header Assemblies .....30-37  
 Right-Angle Header Assemblies .....38-47



**Grace Inertia Connectors (GIC), 3.5 .....49-52**  
 Product Facts .....49  
 Performance Characteristics .....49  
 Contacts and Double Lock Plates .....50  
 Housings: Plug and Cap .....51-52



**.062 [1.57] Commercial Pin and Socket Connectors .....53-57**  
 Product Facts .....53  
 Performance Characteristics .....53-54  
 Contacts .....55  
 Housings: Free-Hanging or Panel Mount .....56-57  
 Recommended Panel Cutouts .....57



**Power Double Lock (PDL) Connectors .....59-81**  
 Product Facts .....59  
 Performance Characteristics .....59  
 Quick Reference Chart for Mating Part Numbers .....60  
 Contacts .....61  
 Housings: Free-Hanging Plug (3.96 mm centerline) .....62-64  
 Free-Hanging Cap (3.96 mm centerline) .....65-66  
 Panel Mount Cap (3.96 mm centerline) .....67-70  
 Double Lock Plates (3.96 mm centerline) .....71  
 Tab Headers, PC Board, Vertical: 3.96 mm centerline .....72-73  
 7.92 mm centerline .....74  
 Housings: Free-Hanging Plug (6.5 mm centerline) .....75-76  
 Double Lock Plates (6.5 mm centerline) .....77  
 Housings: Panel Mount Cap (6.5 mm centerline) .....78  
 Tab Headers, PC Board, Vertical: 6.5 and 13 mm centerlines .....79-81



Produced under a Quality Management System certified to ISO 9001

ACTION PIN, AMP, AMP-DUAC, AMP-O-LECTRIC, AMPOMATOR, AMP-O-MATIC, CERTI-CRIMP, FASTON, MATE-N-LOK, PRO-CRIMPER, TE Logo and Tyco Electronics and VAL-U-LOK are trademarks.

Kapton is a trademark of E.I. du Pont de Nemours and Company.

MOLEX Mini-Fit and Mini-Fit Jr. are trademarks of Molex, Incorporated.

Other products, logos, and Company names mentioned herein may be trademarks of their respective owners.

**Table of Contents** (Continued)

**High Density**  
(Continued)



**Mini-Universal MATE-N-LOK Connectors .....83-94**  
 Product Facts.....83  
 Performance Characteristics.....83-84  
 Mating Combinations.....85  
 Contacts, Keying Plug, Wire Seal and Test Probe Contact.....86  
 Housings: Free-Hanging or Panel Mount.....87-88  
     Hermaphroditic Free-Hanging.....89  
 Headers, PC Board: Vertical Pin and Blindmate.....90-91  
     Right-Angle Pin.....92  
     Recommended PC Board Hole Layouts.....93  
 Plug or Cap Housing Strain Reliefs.....94



**Mini-Universal MATE-N-LOK Sealed Connectors .....95-97**  
 Product Facts.....95  
 Performance Characteristics.....95  
 Plug or Cap Housing.....96  
 Individual Wire Seals.....96  
 Gang Seals and Contacts.....97



**Mini-Universal MATE-N-LOK 2 Connectors .....99-107**  
 Product Facts.....99  
 Performance Characteristics.....99-100  
 Contacts and Keying Plug.....101  
 Housings: Free-Hanging.....101-102  
 Headers, PC Board: Vertical Pin and Blindmate.....103-104  
     Right-Angle Pin.....105  
     Recommended PC Board Hole Layouts.....106  
 Mating Combinations.....107



**(MR) Miniature Rectangular Connectors .....109-118**  
 Product Facts.....109  
 Performance Characteristics.....109-110  
 Mating Combinations.....111  
 Contacts and Keying Plug.....112  
 Housings: Free-Hanging or Panel Mount.....113-114  
     Recommended Panel Cutouts.....115  
     Strain Reliefs, Adapting Grommets and Commoning Bars.....116  
 Headers, PC Board: Vertical Pin.....117-118  
     Recommended PC Board Hole Layouts.....117-118



**VAL-U-LOK Connector System .....119-124**  
 Product Facts.....119  
 Performance Characteristics.....119  
 Contacts.....120  
 Housings (Single Row): Panel Mount Plug.....121  
     Free-Hanging Plug.....121  
     Receptacle.....121  
 Housings (Double Row): Panel Mount Plug.....122  
     Free-Hanging Plug.....122  
     Colored.....122  
     Receptacle.....122  
 Pin Headers, PC Board: Vertical and Right-Angle.....123  
 Blind Mate Headers.....124



**AMP-DUAC Connectors .....125-133**  
 Product Facts.....125  
 Performance Characteristics.....125  
 Receptacle Housings and Female Contacts.....126  
 Plug Housings and Male Contacts.....127  
 Headers, PC Board: Vertical.....128-133  
     Right-Angle.....133  
 Strain Relief, 6 Position (for Receptacle or Plug Housing).....127

**Table of Contents** (Continued)

**Standard Density**



**5.0 mm Power Key Connectors (5.0 PKC).....135-141**  
 Product Facts .....135  
 Performance Characteristics .....135  
 Quick Reference Chart for Mating Part Numbers .....136  
 Contacts and Double Lock Plates .....137  
 Plug Housings: 1 Row .....138  
                   2 Row .....139  
 Headers, PC Board, Vertical: 1 Row .....140  
                           2 Row .....141



**.093 [2.36] Commercial Pin and Socket Connectors .....143-149**  
 Product Facts .....143  
 Performance Characteristics .....143-144  
 Contacts .....145  
 Housings: Free-Hanging or Panel Mount .....146-149



**Commercial MATE-N-LOK Connectors .....151-164**  
 Product Facts .....151  
 Performance Characteristics .....151-152  
 Mating Combinations .....153-154  
 Contacts, Commoning Tabs and Keying Plug .....155-156  
 Housings: Free-Hanging .....157  
                   Positive Lock .....158  
                   Panel Mount .....159  
                   Flange Mount and Motor Mount .....160  
 Headers, PC Board: Vertical Pin .....161  
                           Surface Mount Right-Angle Pin and Vertical Socket .....162  
                           Right-Angle Pin .....163  
 Insulation Displacement Connectors (IDC) and Dust Covers .....163  
 Right-Angle Pin Headers with Fix Belt .....164



**.140 MATE-N-LOK Connectors .....165-167**  
 Product Facts .....165  
 Performance Characteristics .....165  
 Contacts .....166  
 Housings: Free-Hanging .....166  
                   Panel Mount .....167

**Table of Contents** (Continued)

**Standard Density**  
(Continued)



**Universal MATE-N-LOK Connectors .....169-185**  
 Product Facts.....169  
 Performance Characteristics.....169-170  
 Mating Combinations .....171  
 Contacts.....172-173  
 Housings: Free-Hanging or Panel Mount.....174  
     Cap Housing Panel Cutouts, Keying Plugs and  
     Plug Housing Strain Reliefs.....175  
     Plug or Cap Housing Strain Reliefs and Cap Housing Adapters.....176  
     Flanged Cap Housings with Twist and Lock Feature.....177  
 Sealed Bulkhead Connectors.....178-179  
 Splash-Proof Seals.....180  
 Contacts (used with Splash-Proof Seals) .....181  
 Headers, PC Board: Vertical Pin .....182  
     Vertical Socket.....183  
     Recommended PC Board Hole Layouts .....184  
     PC Board Vertical Pin Headers with ACTION PIN Contacts .....184  
     Right-Angle Pin and Socket.....185  
 Test Connectors.....185  
 Circular Connectors .....186-188  
 Universal MATE-N-LOK Connectors — Available in Colors .....188



**Universal MATE-N-LOK II Connectors .....189-202**  
 Product Facts.....189  
 Performance Characteristics.....189-190  
 Mating Combinations .....191  
 Contacts .....192  
 Housing Kits: Free-Hanging or Panel Mount .....193-194  
     Housing Components: Free-Hanging or Panel Mount .....195  
     Plug or Cap Housing Strain Reliefs and Keying Plug.....196  
 Headers, PC Board: Vertical Pin .....197  
     Vertical Socket.....198  
     Recommended PC Board Hole Layouts .....199  
     PC Board Vertical Pin Headers with ACTION PIN Contacts .....199  
     Right-Angle Pin and Socket.....200  
 High Current Contacts .....201  
 High Current Vertical Pin Headers .....202



**.156 MATE-N-LOK Connectors .....203-204**  
 Product Facts.....203  
 Contacts .....203  
 Housings: Free-Hanging.....204  
     Panel Mount.....204

Technical Documents .....205-206  
 Application Tooling .....207-210  
 Applicator Options .....211-213  
 Product Feature Comparisons.....214-215  
 Non-Compliant to RoHS Compliant Part Number Cross Reference .....216-220  
 Part Number Index .....221-226  
 Tooling Part Number Index .....227  
 Global Contacts .....229

---

**Engineering Notes**

---





## 2.5 mm Signal Double Lock (2.5 SDL) Connectors (Wire-to-Board and Wire-to-Wire)

### Product Facts

- Connector for signal circuits with one row of contacts on 2.5 mm centerline
- Wire-to-board and wire-to-wire connectors, consisting of plug and cap housings for wire termination and PC board-mount post headers
- Mounted to plug and cap housings for wire application, double lock plate provides for positive loading of contacts in the housing. It also helps contacts mate completely
- Double lock plate is contained within the plug and cap housing completely, which provides neat overall appearance
- Accepts 26-20 AWG wire (e.g. UL 1007, 1061, 1571, etc.) with insulation diameters of up to 1.8 mm
- PC board-mount post header is available in two styles: standard profile and high profile
- High-profile post header has locking feature at location fit to resin coating, which is applied onto the board for waterproof protection as in home appliances. It does not hamper mating and locking of post header with plug housing
- Locking structure is inner-lock type and has a clean surface
- Solder tail section of post header is provided with kinks to retain the header firmly on PC board during soldering
- Radial tape-mounted version of post header is also available that is applicable to radial mounting machines
- Recognized under the Component Program  of Underwriters Laboratories Inc., File No. E28476
- Certified by Canadian Standards Association,  File No. LR7189
- VDE Approved, File No.  B 04 11 39175013

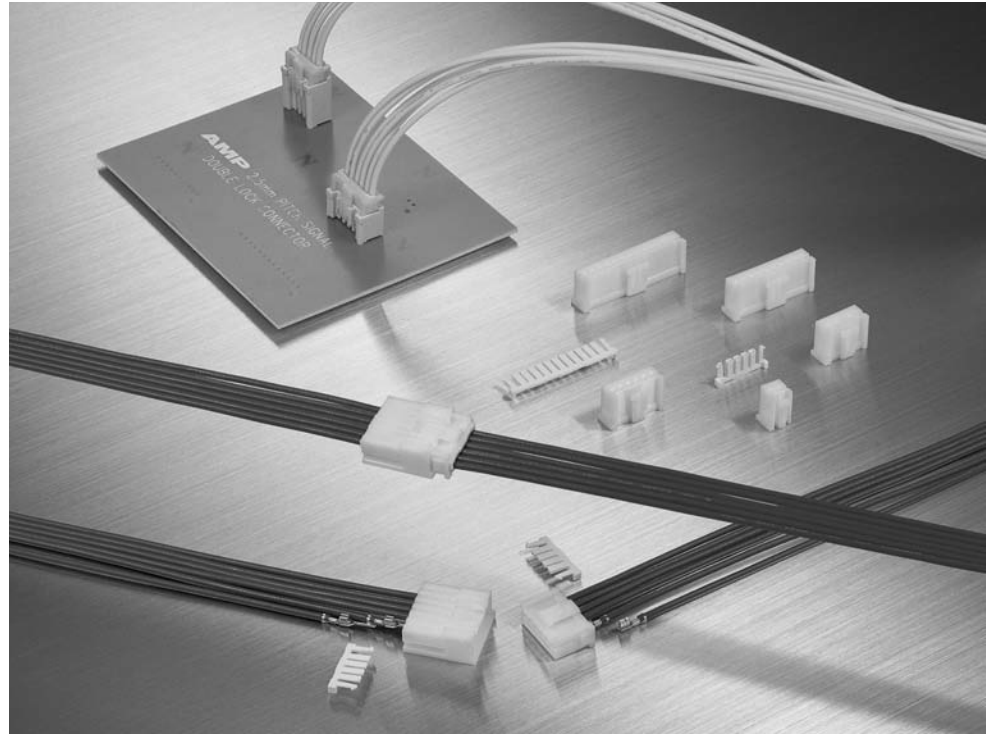

2.5 mm Signal Double Lock Connectors (2.5 SDL) are 2.5 mm centerline, compact, one-row connectors for signal circuits.

With contacts on 2.5 mm centerline, both wire-to-wire and wire-to-board connectors are available.

The connectors consist of plug and cap housings for wire termination, double lock plates for plug and cap housings, crimp snap-in contacts, and a PC board-mount post header. A double lock plate is available for both plug and wire-to-wire cap housing to provide for positive loading. It helps prevent contacts from coming off or mating halfway. The plate is contained within the plug and cap housing completely. The plug and cap housing can be used without a double lock plate.

The connector accepts 26-20 AWG wire (e.g. UL 1007, 1061, 1571, etc.) with insu-

lation diameters of up to 1.8 mm.

The PC board-mount post header is available in two styles: standard profile and high profile.

The high-profile type connectors can be used for home appliances, which require waterproof protection. It does not hamper mating and locking of the post header with the plug housing, even if the board has resin coating on it.

The locking structure is inner-lock type and has a clean surface.

The solder tail of the loose-piece post header has kinks to secure the connector on the PC board until it is soldered.

Radial tape-mounted version of post header is also available and this is applicable to radial mounting machines.

### Performance Characteristics

**Voltage Rating**—50 VAC/DC

**Current Rating**—3 A

**Overall Resistance**—  
10 mΩ max. (initial)  
20 mΩ max. (final)

**Insulation Resistance**—  
500 Ω (500 VDC)

**Dielectric Withstanding Voltage**—  
1,100 VAC, one minute

**Contact Resistance**—20 mΩ max.

**Operating Temperature**—  
-30° ~ +105°C  
(The upper limit includes temperature rise from power carrying)

**Applicable Wire**—26-20 AWG (UL 1007, 1061, 1571)

**Wire Insulation Range**—  
0.93~ 1.8 mm

**PC Board Thickness**—1.6 mm

### Technical Documents

#### Product Specification

108-5459

#### Application Specification

114-5203

**Note:** Dimensions shown are metric.

**2.5 mm Signal Double Lock (2.5 SDL) Connectors  
(Wire-to-Board and Wire-to-Wire) (Continued)**

**Quick Reference Chart for Mating Part Numbers**

| No. of Pos. | Plug Connector Part No.<br>(Wire Side) |                   | Mating Connectors (PC Board Mount & Wire Side) |                   |                        |                   |
|-------------|--|-------------------|--|-------------------|------------------------|-------------------|
|             | Housing                                | Double Lock Plate | Post Header Part No.                           |                   | Cap Connector Part No. |                   |
|             |  |                   | Standard-Profile Type*                         | High-Profile Type | Cap Housing            | Double Lock Plate |
| 2           | 917686-1                               | 917698-1          | 917780-1                                       | 917722-1          | 316086-1               | 917698-1          |
| 3           | 917687-1                               | 917699-1          | 917781-1                                       | 917723-1          | 316087-1               | 917699-1          |
| 4           | 917688-1                               | 917700-1          | 917782-1                                       | 917724-1          | 316088-1               | 917700-1          |
| 5           | 917689-1                               | 917701-1          | 917783-1                                       | 917725-1          | 316089-1               | 917701-1          |
| 6           | 917690-1                               | 917702-1          | 917784-1                                       | 917726-1          | 316090-1               | 917702-1          |
| 7           | 917691-1                               | 917703-1          | 917785-1                                       | 917727-1          | 316091-1               | 917703-1          |
| 8           | 917692-1                               | 917704-1          | 917786-1                                       | 917728-1          | 316092-1               | 917704-1          |
| 9           | 917693-1                               | 917705-1          | 917787-1                                       | 917729-1          | —                      | 917705-1          |
| 10          | 917694-1                               | 917706-1          | 917788-1                                       | 917730-1          | 316094-1               | 917706-1          |
| 11          | 917695-1                               | 917707-1          | 917789-1                                       | 917731-1          | —                      | 917707-1          |
| 12          | 917696-1                               | 917708-1          | 917790-1                                       | 917732-1          | —                      | 917708-1          |
| 13          | 917697-1                               | 917709-1          | 917791-1                                       | 917733-1          | —                      | 917709-1          |

\*Included in Standard-Profile Post Header line are Radial Tape-Mounted version (2 to 8 positions). Refer to appropriate description in the catalog.

**Note:** All part numbers are RoHS Compliant.

**Product Family List (Including Production Plans)**

| Description  | Number of Positions   |   |                     |   |   |   |   |   |    |    |    |    |  |
|--|-----------------------|---|---------------------|---|---|---|---|---|----|----|----|----|--|
|  | 2                     | 3 | 4                   | 5 | 6 | 7 | 8 | 9 | 10 | 11 | 12 | 13 |  |
| Plug Housing                                       | ●                     | ● | ●                   | ● | ● | ● | ● | ● | ●  | ●  | ●  | ●  |  |
| Vertical Board Mount Post Header                   | Standard-Profile Type |   | Loose Piece         |   |   |   |   |   |    |    |    |    |  |
|  | High-Profile Type     |   | Radial Tape-Mounted |   |   |   |   |   |    |    |    |    |  |
| Cap Housing  | Standard-Profile Type |   | Loose Piece         |   |   |   |   |   |    |    |    |    |  |
|  | High-Profile Type     |   | Radial Tape-Mounted |   |   |   |   |   |    |    |    |    |  |
| Double Lock Plate                                  | ●                     | ● | ●                   | ● | ● | ● | ● | ● | ●  | ●  | ●  | ●  |  |
| Horizontal Board Mount Post Header                 | ○                     | ○ | ○                   | ○ | ○ | ○ | ○ | ○ | ○  | ○  | ○  | ○  |  |
| Horizontal Mount Post Header (Radial Tape-Mounted) | ○                     | ○ | ○                   | ○ | ○ | ○ | ○ | — | —  | —  | —  | —  |  |

**Note:** ● indicates products currently available; ○ indicates products planned for production.

**Note:** Dimensions shown are metric.

High Density

2.5 mm Signal Double Lock  
.098 [2.50] Centerline

**2.5 mm Signal Double Lock (2.5 SDL) Connectors  
(Wire-to-Board and Wire-to-Wire) (Continued)**

High Density

2.5 mm Signal Double Lock  
.098 [2.50] Centerline

**Mating Configurations**

**Wire-to-Wire Connections**

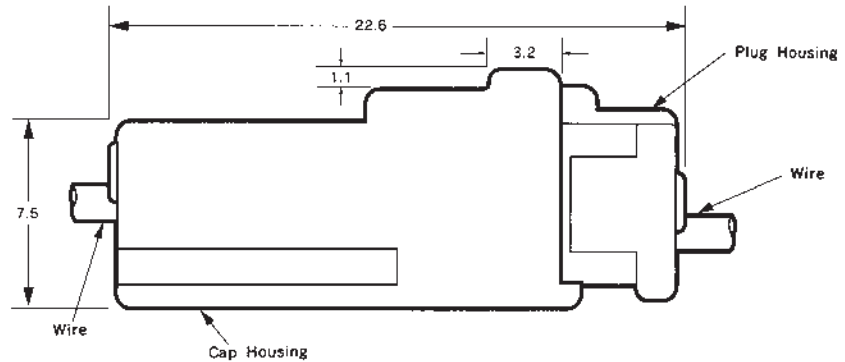

**Wire-to-PC Board Connections**

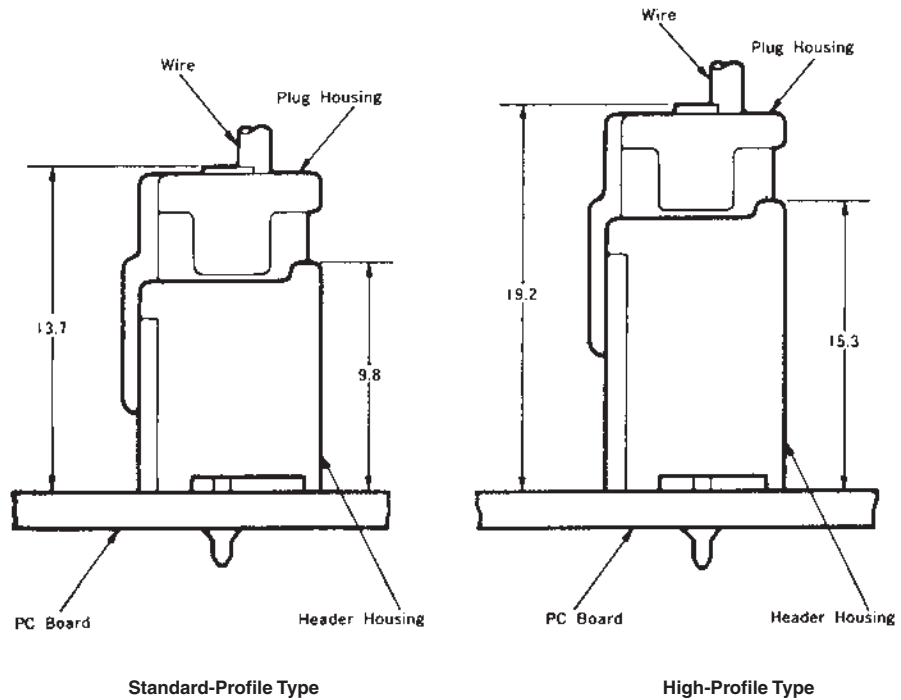

**Note:** Dimensions shown are metric.

**2.5 mm Signal Double Lock (2.5 SDL) Connectors**  
(Wire-to-Board and Wire-to-Wire) (Continued)

**Contacts**

**Material and Finish**

Pre-tinned phosphor bronze  
(0.2 mm thick)

Receptacle for Plug Housing,  
Tab for Cap Housing



| Wire Range |                 | Wire Ins. Dia. | Contact Part Number |             |            |             | Applicator Part Number |
|------------|-----------------|----------------|---------------------|-------------|------------|-------------|------------------------|
| AWG        | mm <sup>2</sup> |                | Tab                 |             | Receptacle |             |                        |
|            |                 |                | Strip Form          | Loose Piece | Strip Form | Loose Piece |                        |
| 26-22      | 0.12~0.35       | 0.93~1.50      | 917765-1            | 316399-1    | 917684-1   | 316401-1    | *                      |
| 22-20      | 0.30~0.53       | 1.40~1.80      | 917764-1            | 316398-1    | 917683-1   | 316400-1    | *                      |

Hand Tool Part No.: for 26-22 AWG = 234604-1 (Instruction Sheet 411-5736)  
22-20 AWG = 234603-1 (Instruction Sheet 411-5735)

Extraction Tool Part No.: 234605-1 (Instruction Sheet 411-5737)

\* Contact the Tooling Assistance Center (TAC) at 1-800-722-1111 for Applicator Part Number.

**Double Lock Plates**

**Material**

UL94V-0, 6/6 Nylon, glass filled,  
natural color



| No. of Pos. | Dimensions of Double Lock Plate |      | Double Lock Plate Part Number | Applicable Housing Part Number |          |
|-------------|---------------------------------|------|-------------------------------|--------------------------------|----------|
|             | A                               | B    |                               | Plug                           | Cap      |
| 2           | 06.5                            | 04.3 | 917698-1                      | 917686-1                       | 316086-1 |
| 3           | 09.0                            | 06.8 | 917699-1                      | 917687-1                       | 316087-1 |
| 4           | 11.5                            | 09.3 | 917700-1                      | 917688-1                       | 316088-1 |
| 5           | 14.0                            | 11.8 | 917701-1                      | 917689-1                       | 316089-1 |
| 6           | 16.5                            | 14.3 | 917702-1                      | 917690-1                       | 316090-1 |
| 7           | 19.0                            | 16.8 | 917703-1                      | 917691-1                       | 316091-1 |
| 8           | 21.5                            | 19.3 | 917704-1                      | 917692-1                       | 316092-1 |
| 9           | 24.0                            | 21.8 | 917705-1                      | 917693-1                       | —        |
| 10          | 26.5                            | 24.3 | 917706-1                      | 917694-1                       | 316094-1 |
| 11          | 29.0                            | 26.8 | 917707-1                      | 917695-1                       | —        |
| 12          | 31.5                            | 29.3 | 917708-1                      | 917696-1                       | —        |
| 13          | 34.0                            | 31.8 | 917709-1                      | 917697-1                       | —        |

Extraction Tool Part No. for Double Lock Plate: 234605-1 (Instruction Sheet 411-5737)

**Note:** All part numbers are RoHS Compliant.

**Note:** Dimensions shown are metric.

**2.5 mm Signal Double Lock (2.5 SDL) Connectors  
(Wire-to-Board and Wire-to-Wire) (Continued)**

High Density  
2.5 mm Signal Double Lock  
.098 [2.50] Centerline

**Plug Housings  
(For Receptacle Contacts)**

**2 to 13 Positions**

**Material**

UL94V-0, 6/6 Nylon, color (see chart)

**Related Product Data**

**Receptacle Contact Part No.**

917684-1 (26-22 AWG)

917683-1 (22-20 AWG)

**Double Lock Plate**—page 12

**Mating Cap Housings**—page 14

**Mating Post Headers**—pages 15-16



| No. of Pos. | Dimensions |      |      | Plug Housing Part Number |          |          |          |          |          |
|-------------|------------|------|------|--------------------------|----------|----------|----------|----------|----------|
|             | A          | B    | C    | Natural                  | Red      | Yellow   | Green    | Blue     | Black    |
| 2           | 02.5       | 07.5 | 06.1 | 917686-1                 | 917686-2 | 917686-4 | 917686-5 | 917686-6 | 917686-9 |
| 3           | 05.0       | 10.0 | 08.6 | 917687-1                 | 917687-2 | 917687-4 | —        | 917687-6 | 917687-9 |
| 4           | 07.5       | 12.5 | 11.1 | 917688-1                 | 917688-2 | 917688-4 | —        | —        | 917688-9 |
| 5           | 10.0       | 15.0 | 13.6 | 917689-1                 | 917689-2 | —        | —        | 917689-6 | —        |
| 6           | 12.5       | 17.5 | 16.1 | 917690-1                 | 917690-2 | 917690-4 | —        | 917690-6 | 917690-9 |
| 7           | 15.0       | 20.0 | 18.6 | 917691-1                 | 917691-2 | 917691-4 | —        | —        | 917691-9 |
| 8           | 17.5       | 22.5 | 21.1 | 917692-1                 | —        | —        | —        | 917692-6 | —        |
| 9           | 20.0       | 25.0 | 23.6 | 917693-1                 | 917693-2 | 917693-4 | —        | —        | —        |
| 10          | 22.5       | 27.5 | 26.1 | 917694-1                 | —        | 917694-4 | —        | —        | —        |
| 11          | 25.0       | 30.0 | 28.6 | 917695-1                 | —        | —        | —        | —        | —        |
| 12          | 27.5       | 32.5 | 31.1 | 917696-1                 | 917696-2 | —        | —        | —        | —        |
| 13          | 30.0       | 35.0 | 33.6 | 917697-1                 | 917697-2 | —        | —        | —        | —        |

**Note:** All part numbers are RoHS Compliant.

**2.5 mm Signal Double Lock (2.5 SDL) Connectors  
(Wire-to-Wire)**

**Cap Housings  
(For Tab Contacts)**

**2 to 10 Positions**

**Material**

UL94V-0, 6/6 Nylon, color (see chart)

**Related Product Data**

**Tab Contact Part No.**

917765-1 (26-22 AWG)

917764-1 (22-20 AWG)

**Double Lock Plate**—page 12

**Mating Plug Housings**—  
page 13



| No. of Pos. | Dimensions |      | Cap Housing Part Number |          |          |          |          |
|-------------|------------|------|-------------------------|----------|----------|----------|----------|
|             | A          | B    | Natural                 | Red      | Yellow   | Blue     | Black    |
| 2           | 02.5       | 08.1 | 316086-1                | 316086-2 | 316086-4 | 316086-6 | 316086-9 |
| 3           | 05.0       | 10.6 | 316087-1                | —        | 316087-4 | —        | 316087-9 |
| 4           | 07.5       | 13.1 | 316088-1                | 316088-2 | 306088-4 | —        | 316088-9 |
| 5           | 10.0       | 15.6 | 316089-1                | 316089-2 | —        | —        | —        |
| 6           | 12.5       | 18.1 | 316090-1                | —        | —        | —        | —        |
| 7           | 15.0       | 20.6 | 316091-1                | —        | —        | —        | 316091-9 |
| 8           | 17.5       | 23.1 | 316092-1                | —        | —        | —        | —        |
| 10          | 22.5       | 28.1 | 316094-1                | —        | 316094-4 | —        | —        |

**Note:** All part numbers are RoHS Compliant.

**Note:** Dimensions shown are metric.

**2.5 mm Signal Double Lock (2.5 SDL) Connectors  
(Wire-to-Wire) (Continued)**

High Density

2.5 mm Signal Double Lock  
.098 [2.50] Centerline

**Vertical Post Headers  
(For PC Board Mount)**

**Standard-Profile Type**

**Material and Finish**

**Header Housings**  
UL94V-0, 6/6 Nylon, glass filled,  
color (see chart)

**Post Contact**  
Pre-tinned copper alloy

**Related Product Data**

**Mating Plug Housings—**  
page 13



**3 to 13 Pos.**

Designs of 5 pos. to 8 pos. header housings are slightly different, please request the drawings.

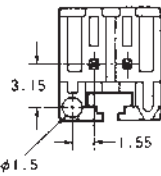

**Section X-X**

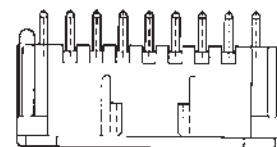
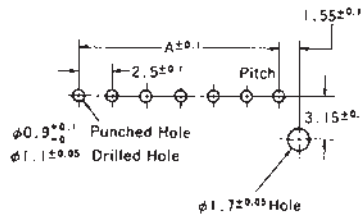

| No. of Pos. | Dimensions |      | Post Header Part Number |              |              |                     |              |              | (Qty.)       |            |        |
|-------------|------------|------|-------------------------|--------------|--------------|---------------------|--------------|--------------|--------------|------------|--------|
|             | A          | B    | Loose Piece             |              |              | Radial Tape-Mounted |              |              |              |            |        |
|             |            |      | Natural                 | Red          | Yellow       | Blue                | Black        | Natural      |              | Red        | Yellow |
| 2           | 02.5       | 07.5 | □-917780-1*1            | □-917780-2*1 | —            | —                   | □-917780-9*1 | □-917894-1*3 | —            | —          | (900)  |
| 3           | 05.0       | 10.0 | □-917781-1*1            | □-917781-2*1 | —            | —                   | □-917781-9*1 | □-917895-1*4 | □-917895-2   | —          | (900)  |
| 4           | 07.5       | 12.5 | □-917782-1*1            | □-917782-2*1 | □-917782-4*1 | —                   | □-917782-9*1 | □-917896-1   | —            | —          | (450)  |
| 5           | 10.0       | 15.0 | □-917783-1*1            | □-917783-2*1 | —            | □-917783-6          | —            | □-917897-1   | □-917897-2   | —          | (450)  |
| 6           | 12.5       | 17.5 | □-917784-1*1            | □-917784-2*1 | —            | —                   | □-917784-9*1 | □-917898-1   | —            | —          | (450)  |
| 7           | 15.0       | 20.0 | □-917785-1*1            | □-917785-2   | □-917785-4*1 | —                   | —            | □-917899-1*5 | 3-917899-2*6 | □-917899-4 | (450)  |
| 8           | 17.5       | 22.5 | □-917786-1*1            | —            | —            | □-917786-6*         | —            | □-917900-1   | —            | —          | (450)  |
| 9           | 20.0       | 25.0 | □-917787-1*1            | □-917787-2   | —            | —                   | —            | —            | —            | —          | —      |
| 10          | 22.5       | 27.5 | □-917788-1*1            | —            | —            | —                   | —            | —            | —            | —          | —      |
| 11          | 25.0       | 30.0 | □-917789-1*1            | —            | —            | —                   | —            | —            | —            | —          | —      |
| 12          | 27.5       | 32.5 | □-917790-1*1            | □-917790-2   | —            | —                   | —            | —            | —            | —          | —      |
| 13          | 30.0       | 35.0 | □-917791-1*1            | □-917791-2   | —            | —                   | —            | —            | —            | —          | —      |

\*1 Leave the □ blank, meaning it is with the boss. Enter 2 meaning it is without the boss.  
 \*2 Leave the □ blank, meaning it is with the boss and the kink. Enter 1 meaning it is without the boss and the kink. Enter 2 meaning it is with the boss and with the kink.

\*3 The blue housing 917894-6 is also available.  
 \*4 The blue housing 917895-6 and the black housing 917895-9 are also available.  
 \*5 Leave the □ blank, meaning it is without the boss. Enter 3 meaning it is with the boss.  
 \*6 It is without the boss.

**Note: All part numbers are RoHS Compliant.**

**Note: Dimensions shown are metric.**

## 2.5 mm Signal Double Lock (2.5 SDL) Connectors (Wire-to-Wire) (Continued)

### Vertical Post Headers (For PC Board Mount)

#### High-Profile Type

#### Material and Finish

**Header Housing**—UL94V-0, 6/6 Nylon, glass filled, color (see chart)

**Post Contact**—Pre-tinned copper alloy

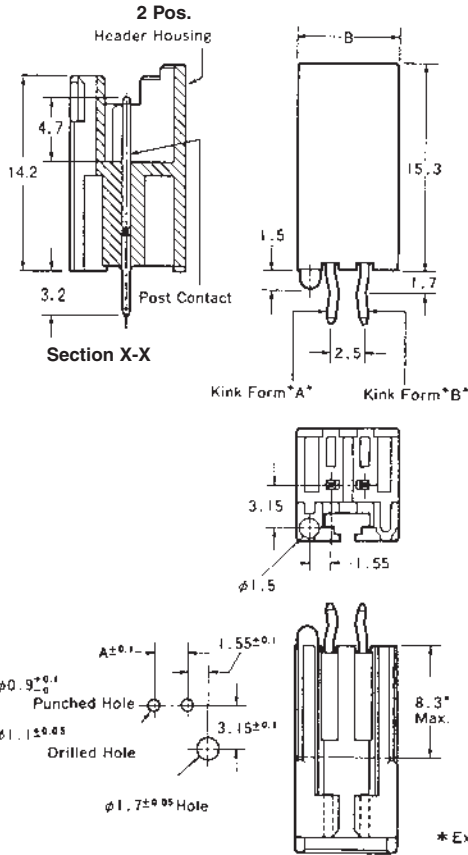

### Related Product Data

Mating Plug Housings—page 13

3 to 13 Pos.

Designs of 5 pos. to 8 pos. header housings are slightly different, please request the drawings.

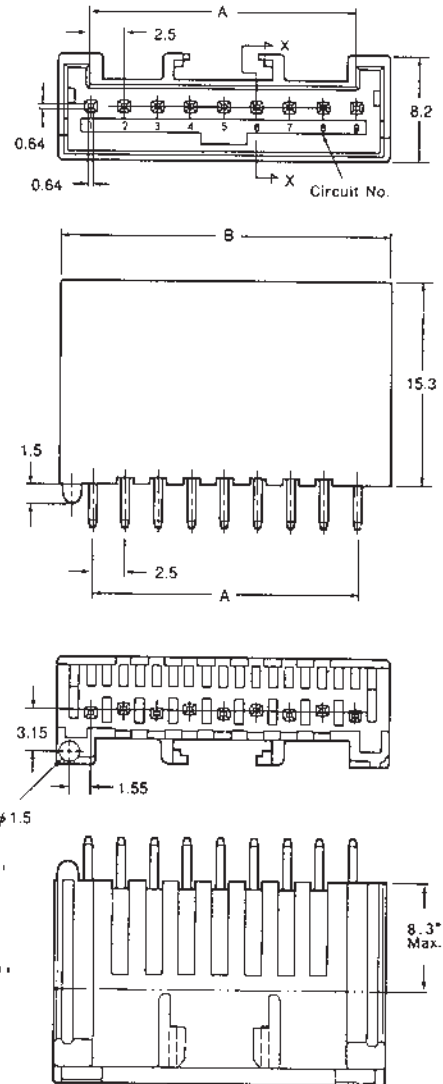

**Note:** Dimensions shown are metric.

| No. of Pos. | Dimensions |      | Post Header Part Number |              |              |              |              |              | Radial Tape-Mounted | (Qty.)             |
|-------------|------------|------|-------------------------|--------------|--------------|--------------|--------------|--------------|---------------------|--------------------|
|             | A          | B    | Loose Piece             |              |              |              |              |              |                     |                    |
|             |            |      | Natural                 | Red          | Yellow       | Green        | Blue         | Black        | Natural             |                    |
| 2           | 02.5       | 07.5 | □-917722-1*1            | □-917722-2*1 | □-917722-4*1 | □-917722-5*1 | □-917722-6*1 | □-917722-9*1 | 316221-1            | (900) <sup>2</sup> |
| 3           | 05.0       | 10.0 | □-917723-1*1            | —            | —            | —            | —            | —            | 316222-1            | (900)              |
| 4           | 07.5       | 12.5 | □-917724-1*1            | —            | —            | —            | —            | —            | 316223-1            | (450)              |
| 5           | 10.0       | 15.0 | □-917725-1*1            | —            | —            | —            | —            | —            | 316224-1            | (450)              |
| 6           | 12.5       | 17.5 | □-917726-1*1            | —            | □-917726-4*1 | —            | □-917726-6*1 | —            | 316225-1            | (450)              |
| 7           | 15.0       | 20.0 | □-917727-1*1            | —            | —            | —            | —            | —            | 316226-1            | (450)              |
| 8           | 17.5       | 22.5 | □-917728-1*1            | —            | —            | —            | —            | —            | 316227-1            | (450)              |
| 9           | 20.0       | 25.0 | □-917729-1*1            | —            | —            | —            | —            | —            | —                   | —                  |
| 10          | 22.5       | 27.5 | □-917730-1*1            | —            | —            | —            | —            | —            | —                   | —                  |
| 11          | 25.0       | 30.0 | □-917731-1*1            | —            | —            | —            | —            | —            | —                   | —                  |
| 12          | 27.5       | 32.5 | □-917732-1*1            | —            | —            | —            | —            | —            | —                   | —                  |
| 13          | 30.0       | 35.0 | □-917733-1*1            | —            | —            | —            | —            | —            | —                   | —                  |

\*1 Leave the □ blank, meaning it is with the boss. Enter 2 meaning it is without the boss.

\*2 The red housing 316221-2 and the yellow housing 316221-4 and the green housing 316221-5 and the blue housing 316221-6 and the black housing 316221-9 are also available.

**Note:** All part numbers are RoHS Compliant.



## Micro MATE-N-LOK 3 mm Connector System

### Product Facts

- Wire-to-wire and wire-to-board pin and receptacle connector system
- Contacts are on 3 mm [.118] centerline spacing
- 2-12 contact positions – single row
- 2-24 contact positions – dual row
- Panel mount or free-hanging wire-to-wire configurations
- Dual beam contact design for reliable interconnection
- Contacts accept 24-20 [0.2-0.6] and 30-26 [0.05-0.15] AWG wire with insulation diameter of .060 [1.52] maximum
- Contacts available in strip form or loose piece
- Pcb mount pin header assemblies in both vertical and right-angle styles
- Surface mount or through-hole pcb pin header attachment
- Pcb headers are IR reflow process compatible
- Recognized under the Component Program of Underwriters Laboratories Inc.  to US and Canadian Standards, File No. E28476
- Passed Tests for VDE under Registration Number 40005280/Continuous Surveillance 

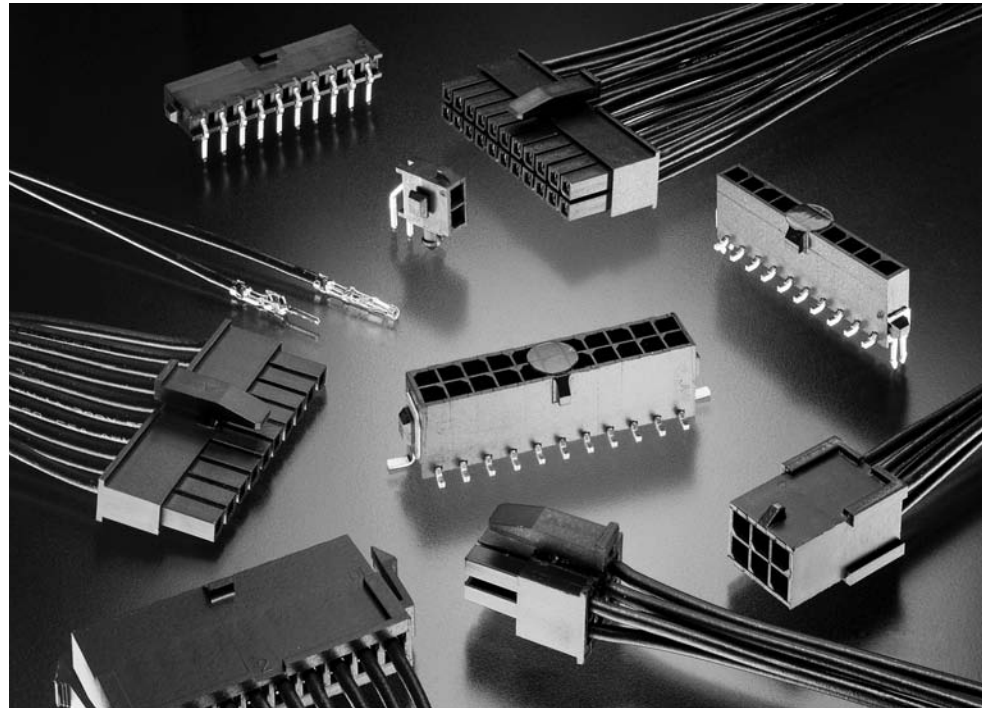

The Micro MATE-N-LOK 3 mm Connector System is a wire-to-wire and wire-to-board connector system with contacts on a 3 mm [.118] centerline. Both single-row and dual-row configurations are available. Crimp, snap-in pin and receptacle contacts are used to terminate 24-20 [0.2-0.6] and 30-26 [0.05-0.15] AWG wire. Plug and receptacle housings allow wire-to-wire and wire-to-panel configurations.

Header assemblies for wire-to-board interconnections include vertical and right-angle components. These IR reflow process compatible headers are available in through-hole and surface mount configurations.

Typical uses of the Micro MATE-N-LOK 3 mm Connector System include the appliance, instrumentation, industrial machinery, home equipment, and security system industries.

### Technical Documents

#### Application Specification

114-13000 Micro MATE-N-LOK Connectors

#### Product Specification

108-1836 3 mm Micro MATE-N-LOK Connector

### Performance Characteristics

**Voltage Rating**—250 vac

**Current Rating**—5 amp max. on 20 AWG wire

**Contact Resistance**—20 milliohms max. final

**Dielectric Withstanding Voltage**—1500 VAC

**Insulation Resistance**—1000 megohms min.

**Operating Temperature**—-40°C to +105°C

**Mating Force**—1.5lb [6.67N] max per contact

**Micro MATE-N-LOK 3 mm Connector System (Continued)**

**Connector Application** . . . . . 19-21  
Crimp, Snap-In Contacts . . . . . 22

**Receptacle Housings**  
Single Row . . . . . 23  
Dual Row . . . . . 24

**Plug Housings**  
Single Row, Free-Hanging . . . . . 25  
Single Row, Panel Mount . . . . . 26  
Dual Row, Free-Hanging . . . . . 27  
Dual Row, Panel Mount . . . . . 28

**Vertical Header Assemblies**  
Low Profile Receptacle Housings,  
Right Angle Surface Mount Housings. . . . . 29  
Single Row, Through-Hole, with Retention Feature  
on Solder-tail and Polarization Feature to PCB . . . . . 30  
Single Row, Through-Hole, with Metal Through-Hole Hold-down . . . . . 31  
Single Row, Surface Mount, with Metal Through-Hole Hold-down . . . . . 32  
Single Row, Surface Mount, with Surface Mount Hold-down . . . . . 33  
Dual Row, Through-Hole, with Retention Feature on Solder-tail . . . . . 34  
Dual Row, Through-Hole, with Retention Feature  
on Solder-tail and Metal Through-Hole Hold-down . . . . . 35  
Dual Row, Surface Mount, with Metal Through-Hole Hold-down. . . . . 36  
Dual Row, Surface Mount, with Surface Mount Hold-down . . . . . 37

**Right-Angle Header Assemblies**  
Single Row, Through-Hole, with Metal Through-Hole Hold-down . . . . . 38  
Single Row, Through-Hole, with Plastic Boardlock . . . . . 39  
Single Row, Surface Mount, with Metal Through-Hole Hold-down . . . . . 40  
Single Row, Surface Mount, with Surface Mount Hold-down . . . . . 41  
Single Row, Surface Mount, with Plastic Boardlock. . . . . 42  
Dual Row, Through-Hole, with Metal Through-Hole Hold-down . . . . . 43  
Dual Row, Through-Hole, with Plastic Boardlock. . . . . 44  
Dual Row, Surface Mount, with Metal Through-Hole Hold-down. . . . . 45  
Dual Row, Surface Mount, with Plastic Boardlock. . . . . 46  
Dual Row, Surface Mount, with Surface Mount Hold-down . . . . . 47

**Current Rating Verification for 30°C Maximum Temperature Rise 100% Energized**



| Number of Circuit Positions | Multiplication Factor |      |
|-----------------------------|-----------------------|------|
|                             | Wire Size (AWG)       |      |
| 2 to 6                      | 0.40                  | 1    |
| 8 to 20                     | 0.40                  | 0.85 |
| 22 to 24                    | 0.36                  | 0.85 |

To determine acceptable current carrying capacity for connector size and wire gage indicated, use the Multiplication Factor from the chart above and multiply it times the Base rated Current at the maximum ambient operating temperature shown in the current rating figure.

High Density

Micro MATE-N-LOK 3 mm Connector System  
.118 [3.00] Centerline

**Micro MATE-N-LOK 3 mm Connector System** (Continued)

**Connector Application —  
Wire-to-Wire and  
Wire-to-Panel**

**Single Row**

| Receptacle  |   | Plug  |   |
|---|---|---|---|
| Contact   | Housing   | Contact   | Housing   |
|  |  |  |  |
| □-794606-□, □-794607-□,<br>□-794610-□, □-794611-□<br>Page 22                      | □-1445022-□<br>Page 23  | □-794608-□, □-794609-□,<br>□-794612-□, □-794613-□<br>Page 22                        | Free-Hanging<br>□-1445049-□<br>Page 25<br><br>Panel Mount<br>□-1445048-□<br>Page 26 |

**Dual Row**

| Receptacle  |   | Plug  |   |
|---|---|---|---|
| Contact   | Housing   | Contact   | Housing   |
|  |  |  |  |
| □-794606-□, □-794607-□,<br>□-794610-□, □-794611-□<br>Page 22                        | □-794617-□<br>Page 24   | □-794608-□, □-794609-□,<br>□-794612-□, □-794613-□<br>Page 22                          | Free-Hanging<br>□-794616-□<br>Page 27<br><br>Panel Mount<br>□-794615-□<br>Page 28     |

High Density

Micro MATE-N-LOK 3 mm Connector System  
.118 [3.00] Centerline

**Micro MATE-N-LOK 3 mm Connector System (Continued)**



**Connector Application —  
Wire-to-PCB**

**Single Row**

| Receptacle  |  |
|---|--|
| Contact   | Housing  |
|  <p>□-794606-□, □-794607-□,<br/>□-794610-□, □-794611-□<br/>(Page 22)</p>   |  <p>□-1445022-□<br/>(Page 23)</p>   |
|  <p>□-794606-□, □-794607-□,<br/>□-794610-□, □-794611-□<br/>(Page 29)</p> |  <p>□-2029047-□, □-2029102-□,<br/>□-2029030-□, □-2029104-□,<br/>(Page 29)</p> |

**Low Profile, Single Row**

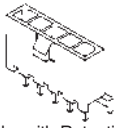
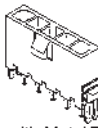
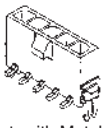
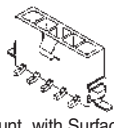
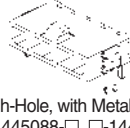
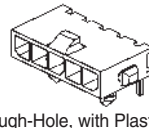
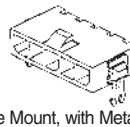
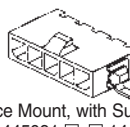
**Header**

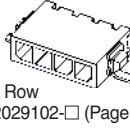
|   |
|---|
|  <p>Vertical Through-Hole, with Retention Feature on Solder-tail and Polarization Feature to PCB<br/>□-1445050-□, □-1445084-□, □-1445093-□ (Page 30)</p> |
|  <p>Vertical Through-Hole, with Metal Through-Hole Hold-down<br/>□-1445051-□, □-1445085-□, □-1445094-□ (Page 31)</p>                                     |
|  <p>Vertical Surface Mount, with Metal Through-Hole Hold-down<br/>□-1445052-□, □-1445086-□, □-1445095-□ (Page 32)</p>                                    |
|  <p>Vertical Surface Mount, with Surface Mount Hold-down<br/>□-1445053-□, □-1445087-□, □-1445096-□ (Page 33)</p>   |
|  <p>Right-angle, Through-Hole, with Metal Through-Hole Hold-down<br/>□-1445054-□, □-1445088-□, □-1445097-□ (Page 38)</p>                                |
|  <p>Right-angle, Through-Hole, with Plastic Boardlock<br/>□-1445055-□, □-1445089-□, □-1445098-□ (Page 39)</p>  |
|  <p>Right-angle, Surface Mount, with Metal Through-Hole Hold-down<br/>□-1445056-□, □-1445090-□, □-1445099-□ (Page 40)</p>                              |
|  <p>Right-angle, Surface Mount, with Surface Mount Hold-down<br/>□-1445057-□, □-1445091-□, □-1445100-□ (Page 41)</p>                                   |
|  <p>Right-angle, Surface Mount, and Plastic Boardlock<br/>□-1445058-□, □-1445092-□, □-1445101-□ (Page 42)</p>  |
|  <p>Low Profile, Single Row<br/>□-2029030-□, □-2029102-□ (Page 29)</p>   |



High Density  
Micro MATE-N-LOK 3 mm Connector System  
.118 [3.00] Centerline

**Micro MATE-N-LOK 3 mm Connector System (Continued)**

**Connector Application —  
Wire-to-PCB**

**Dual Row**

| Receptacle  |   | Header  |
|---|---|---|
| Contact   | Housing   |   |
|  <p>□-794606-□, □-794607-□,<br/>□-794610-□, □-794611-□<br/>(Page 22)</p> |  <p>□-794617-□<br/>(Page 24)</p> | <div style="text-align: center;">  <p>Vertical Through-Hole, with Retention Feature on Solder-tail and Optional Metal Through-Hole Hold-down<br/>□-794630-□, □-794631-□, □-794632-□, (Page 34)<br/>□-794680-□, □-794681-□, □-794682-□ (Page 35)</p> </div> <div style="text-align: center;">  <p>Vertical Surface Mount, with Metal Through-Hole Hold-down<br/>□-794633-□, □-794634-□, □-794635-□ (Page 36)</p> </div> <div style="text-align: center;">  <p>Vertical Surface Mount, with Surface Mount Hold-down<br/>□-794636-□, □-794637-□, □-794638-□ (Page 37)</p> </div> <div style="text-align: center;">  <p>Right-angle, Through-Hole, with Metal Through-Hole Hold-down<br/>□-794677-□, □-794678-□, □-794679-□ (Page 43)</p> </div> <div style="text-align: center;">  <p>Right-angle, Through-Hole, with Plastic Boardlock<br/>□-794618-□, □-794619-□, □-794620-□ (Page 44)</p> </div> <div style="text-align: center;">  <p>Right-angle, Surface Mount, with Metal Through-Hole Hold-down<br/>□-794624-□, □-794625-□, □-794626-□ (Page 45)</p> </div> <div style="text-align: center;">  <p>Right-angle, Surface Mount, with Plastic Boardlock<br/>□-794621-□, □-794622-□, □-794623-□ (Page 46)</p> </div> <div style="text-align: center;">  <p>Right-angle, Surface Mount, with Surface Mount Hold-down<br/>□-794627-□, □-794628-□, □-794629-□ (Page 47)</p> </div> |

High Density

Micro MATE-N-LOK 3 mm Connector System  
.118 [3.00] Centerline

**Micro MATE-N-LOK 3 mm Connector System (Continued)**

**Crimp, Snap-In Contacts**



**Material and Finish**

**Receptacle** — Phosphor Bronze

**Plug** — Brass

**Plating A** — .000100 (.000254) minimum bright tin entire stock over .000050 (.000127) minimum nickel entire stock

**Plating B** — .000015 (.000038) minimum gold in localized gold plate area. .000100 (.000254) minimum bright tin in localized tin plate area, both over .000050 (.000127) minimum nickel on entire stock

**Plating C** — .000030 (.000076) minimum gold in localized gold plate area. .000100 (.000254) minimum bright tin in localized tin plate area, both over .000050 (.000127) minimum nickel on entire stock



**Receptacle Contacts**

| Wire Size Range<br>AWG [mm <sup>2</sup> ] | Ins. Dia. Range          | Finish    | Contact Part Numbers |             | Tooling Part Numbers |           |
|---|--------------------------|-----------|----------------------|-------------|----------------------|-----------|
|   |                          |           | Strip Form           | Loose Piece | Applicator           | Hand Tool |
| 20-24<br>0.50 - 0.20                      | .035 - .060<br>0.89-1.52 | Plating A | 794606-1             | 794610-1    | 680893-□*            | 91501-1   |
|   |                          | Plating B | 1-794606-1           | 1-794610-1  |                      |           |
|   |                          | Plating C | 1-794606-2           | 1-794610-2  |                      |           |
| 26-30<br>0.12 - 0.05                      | .035 - .060<br>0.89-1.52 | Plating A | 794607-1             | 794611-1    | 680894-□*            | 91502-1   |
|   |                          | Plating B | 1-794607-1           | 1-794611-1  |                      |           |
|   |                          | Plating C | 1-794607-2           | 1-794611-2  |                      |           |

\*1=AMPOMATOR CLS Machine, 2=AMP-O-LECTRIC Model K Terminator, 3=AMP-O-LECTRIC Model G Terminator

**Note:** All part numbers are RoHS Compliant.

**Related Product Data**

**Connectors used with:**

Receptacle Contacts used with Receptacle Housings — pages 23-24

Plug Contacts used with Plug Housings — pages 25-28

**Application Tooling**— pages 207-210



**Plug Contacts**

| Wire Size Range<br>AWG [mm <sup>2</sup> ] | Ins. Dia. Range          | Finish    | Contact Part Numbers |             | Tooling Part Numbers |           |
|---|--------------------------|-----------|----------------------|-------------|----------------------|-----------|
|   |                          |           | Strip Form           | Loose Piece | Applicator           | Hand Tool |
| 20-24<br>0.50 - 0.20                      | .035 - .060<br>0.89-1.52 | Plating A | 1-794608-0           | 1-794612-0  | 1385194-□*           | 91501-1   |
|   |                          | Plating B | 1-794608-1           | 1-794612-1  |                      |           |
|   |                          | Plating C | 1-794608-2           | 1-794612-2  |                      |           |
| 26-30<br>0.12 - 0.05                      | .035 - .060<br>0.89-1.52 | Plating A | 1-794609-0           | 1-794613-0  | 1385377-□*           | 91502-1   |
|   |                          | Plating B | 1-794609-1           | 1-794613-1  |                      |           |
|   |                          | Plating C | 1-794609-2           | 1-794613-2  |                      |           |

\*1=AMPOMATOR CLS Machine, 2=AMP-O-LECTRIC Model K Terminator, 3=AMP-O-LECTRIC Model G Terminator

**Note:** All part numbers are RoHS Compliant.

**Contact Extraction Tools**

Part Number 843996-6 for Receptacle Contacts Part Number 1586344-1 for Plug Contacts

High Density

Micro MATE-N-LOK 3 mm Connector System  
.118 [3.00] Centerline

**Micro MATE-N-LOK 3 mm Connector System** (Continued)

High Density

Micro MATE-N-LOK 3 mm Connector System  
.118 [3.00] Centerline

**Receptacle Housings**

**Single Row**

**Material**

Nylon, Black  
Flammability Rating—UL 94V-0

**Related Product Data**

**Contacts:**

Receptacle Contacts—page 22

**Mateable Housings and Headers:**

Single Row Plug Housings—  
pages 25-26  
Single Row Vertical Pin Header  
Assemblies—pages 30-37  
Single Row Right-Angle Pin Header  
Assemblies—pages 38-47



| Number of Circuits | Dimension A    | Part Numbers |
|--------------------|----------------|--------------|
| 2                  | .276<br>7.00   | 1445022-2    |
| 3                  | .394<br>10.00  | 1445022-3    |
| 4                  | .512<br>13.00  | 1445022-4    |
| 5                  | .630<br>16.00  | 1445022-5    |
| 6                  | .748<br>19.00  | 1445022-6    |
| 7                  | .866<br>22.00  | 1445022-7    |
| 8                  | .984<br>25.00  | 1445022-8    |
| 9                  | 1.102<br>28.00 | 1445022-9    |
| 10                 | 1.220<br>31.00 | 1-1445022-0  |
| 11                 | 1.339<br>34.00 | 1-1445022-1  |
| 12                 | 1.457<br>37.00 | 1-1445022-2  |

**Note:** All part numbers are RoHS Compliant.

**Micro MATE-N-LOK 3 mm Connector System (Continued)**

**Receptacle Housings**  
(Continued)

**Dual Row**

**Material**

Nylon, Black  
Flammability Rating—UL 94V-0

**Related Product Data**

**Contacts:**

Receptacle Contacts—page 22

**Mateable Housings and Headers:**

Dual Row Plug Housings—pages 27-28  
Dual Row Vertical Pin Header Assemblies—pages 34-37  
Dual Row Right-Angle Pin Header Assemblies—pages 43-47



| Number of Circuits | Dimension A    | Part Numbers |
|--------------------|----------------|--------------|
| 2                  | .157<br>4.00   | 794617-2     |
| 4                  | .276<br>7.00   | 794617-4     |
| 6                  | .394<br>10.00  | 794617-6     |
| 8                  | .512<br>13.00  | 794617-8     |
| 10                 | .630<br>16.00  | 1-794617-0   |
| 12                 | .748<br>19.00  | 1-794617-2   |
| 14                 | .866<br>22.00  | 1-794617-4   |
| 16                 | .984<br>25.00  | 1-794617-6   |
| 18                 | 1.102<br>28.00 | 1-794617-8   |
| 20                 | 1.220<br>31.00 | 2-794617-0   |
| 22                 | 1.339<br>34.00 | 2-794617-2   |
| 24                 | 1.457<br>37.00 | 2-794617-4   |

**Note:** All part numbers are RoHS Compliant.

High Density

Micro MATE-N-LOK 3 mm Connector System  
.118 [3.00] Centerline



**Micro MATE-N-LOK 3 mm Connector System** (Continued)

**Plug Housings**

**Single Row, Free-Hanging**

**Material**

Nylon, Black  
Flammability Rating—UL 94V-0

**Related Product Data**

**Contacts:**

Plug Contacts—page 22

**Mateable Housings:**

Single Row Receptacle Housings—  
page 23

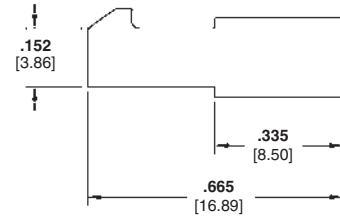

| Number of Circuits | Dimension A    | Part Numbers |
|--------------------|----------------|--------------|
| 2                  | .270<br>6.85   | 1445049-2    |
| 3                  | .388<br>9.85   | 1445049-3    |
| 4                  | .506<br>12.85  | 1445049-4    |
| 5                  | .624<br>15.85  | 1445049-5    |
| 6                  | .742<br>18.85  | 1445049-6    |
| 7                  | .860<br>21.85  | 1445049-7    |
| 8                  | .978<br>24.85  | 1445049-8    |
| 9                  | 1.096<br>27.85 | 1445049-9    |
| 10                 | 1.215<br>30.85 | 1-1445049-0  |
| 11                 | 1.333<br>33.85 | 1-1445049-1  |
| 12                 | 1.451<br>36.85 | 1-1445049-2  |

**Note:** All part numbers are RoHS Compliant.

**Micro MATE-N-LOK 3 mm Connector System (Continued)**

**Plug Housings (Continued)**

**Single Row, Panel Mount**

**Material**

Nylon, Black  
Flammability Rating—UL 94V-0

**Related Product Data**

**Contacts:**

Plug Contacts—page 22

**Mateable Housings:**

Single Row Receptacle Housings—  
page 23



**Recommended Panel Cutout\***

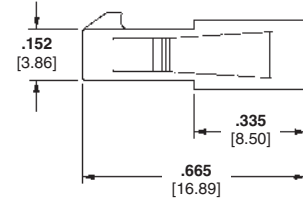
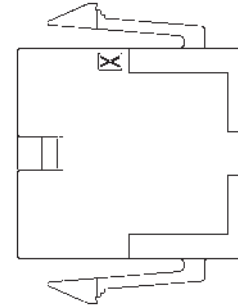

| Number of Circuits | Dimensions     |                |                | Part Numbers |
|--------------------|----------------|----------------|----------------|--------------|
|                    | A              | B              | C              |              |
| 2                  | .270<br>6.85   | .283<br>7.20   | .428<br>10.88  | 1445048-2    |
| 3                  | .388<br>9.85   | .402<br>10.20  | .546<br>13.88  | 1445048-3    |
| 4                  | .506<br>12.85  | .520<br>13.20  | .665<br>16.88  | 1445048-4    |
| 5                  | .624<br>15.85  | .638<br>16.20  | .783<br>19.88  | 1445048-5    |
| 6                  | .742<br>18.85  | .756<br>19.20  | .901<br>22.88  | 1445048-6    |
| 7                  | .860<br>21.85  | .874<br>22.20  | 1.019<br>25.88 | 1445048-7    |
| 8                  | .978<br>24.85  | .992<br>25.20  | 1.137<br>28.88 | 1445048-8    |
| 9                  | 1.096<br>27.85 | 1.110<br>28.20 | 1.255<br>31.88 | 1445048-9    |
| 10                 | 1.215<br>30.85 | 1.228<br>31.20 | 1.373<br>34.88 | 1-1445048-0  |
| 11                 | 1.333<br>33.85 | 1.346<br>34.20 | 1.491<br>37.88 | 1-1445048-1  |
| 12                 | 1.451<br>36.85 | 1.465<br>37.20 | 1.609<br>40.88 | 1-1445048-2  |

\*Recommended panel thickness .062-.091 [1.57-2.30]. Always consult customer drawing for panel cutout dimensions.

**Note: All part numbers are RoHS Compliant.**

High Density  
Micro MATE-N-LOK 3 mm Connector System  
.118 [3.00] Centerline

**Micro MATE-N-LOK 3 mm Connector System** (Continued)

**Plug Housings** (Continued)

**Dual Row, Free-Hanging**

**Material**

Nylon, Black  
Flammability Rating—UL 94V-0

**Related Product Data**

**Contacts:**

Plug Contacts—page 22

**Mateable Housings:**

Dual Row Receptacle Housings—  
page 24



| Number of Circuits | Dimension A    | Part Numbers |
|--------------------|----------------|--------------|
| 2                  | .157<br>3.85   | 794616-2     |
| 4                  | .276<br>6.85   | 794616-4     |
| 6                  | .394<br>9.85   | 794616-6     |
| 8                  | .512<br>12.85  | 794616-8     |
| 10                 | .630<br>15.85  | 1-794616-0   |
| 12                 | .748<br>18.85  | 1-794616-2   |
| 14                 | .866<br>21.85  | 1-794616-4   |
| 16                 | .984<br>24.85  | 1-794616-6   |
| 18                 | 1.102<br>27.85 | 1-794616-8   |
| 20                 | 1.220<br>30.85 | 2-794616-0   |
| 22                 | 1.339<br>33.85 | 2-794616-2   |
| 24                 | 1.457<br>36.85 | 2-794616-4   |

**Note:** All part numbers are RoHS Compliant.

**Micro MATE-N-LOK 3 mm Connector System (Continued)**

**Plug Housings (Continued)**

**Dual Row, Panel Mount**

**Material**

Nylon, Black  
Flammability Rating—UL 94V-0

**Related Product Data**

**Contacts:**

Plug Contacts—page 22

**Mateable Housings:**

Dual Row Receptacle Housings—  
page 24



**Recommended Panel Cutout\***

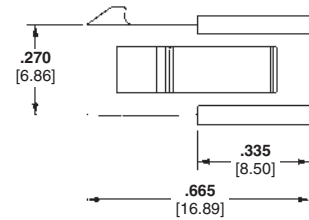

| Number of Circuits | Dimensions     |                |                | Part Numbers |
|--------------------|----------------|----------------|----------------|--------------|
|                    | A              | B              | C              |              |
| 2                  | .157<br>3.85   | .165<br>4.20   | .310<br>7.88   | 794615-2     |
| 4                  | .276<br>6.85   | .285<br>7.20   | .428<br>10.88  | 794615-4     |
| 6                  | .394<br>9.85   | .402<br>10.20  | .546<br>13.88  | 794615-6     |
| 8                  | .512<br>12.85  | .520<br>13.20  | .665<br>16.88  | 794615-8     |
| 10                 | .630<br>15.85  | .638<br>16.20  | .783<br>19.88  | 1-794615-0   |
| 12                 | .748<br>18.85  | .756<br>19.20  | .901<br>22.88  | 1-794615-2   |
| 14                 | .866<br>21.85  | .874<br>22.20  | 1.019<br>25.88 | 1-794615-4   |
| 16                 | .984<br>24.85  | .992<br>25.20  | 1.137<br>28.88 | 1-794615-6   |
| 18                 | 1.102<br>27.85 | 1.110<br>28.20 | 1.255<br>31.88 | 1-794615-8   |
| 20                 | 1.220<br>30.85 | 1.228<br>31.20 | 1.373<br>34.88 | 2-794615-0   |
| 22                 | 1.339<br>33.85 | 1.346<br>34.20 | 1.491<br>37.88 | 2-794615-2   |
| 24                 | 1.457<br>36.85 | 1.469<br>37.20 | 1.609<br>40.88 | 2-794615-4   |

\*Recommended panel thickness .062-.091 [1.57-2.30]. Always consult customer drawing for panel cutout dimensions.

**Note:** All part numbers are RoHS Compliant.

High Density  
Micro MATE-N-LOK 3 mm Connector System  
.118 [3.00] Centerline

**Micro MATE-N-LOK 3 mm Connector System (Continued)**

High Density

Micro MATE-N-LOK 3 mm Connector System  
.118 [3.00] Centerline

**New: Low Profile**

**Low Profile Receptacle Housings**

**Material**

Nylon, Black  
Flammability Rating—V0

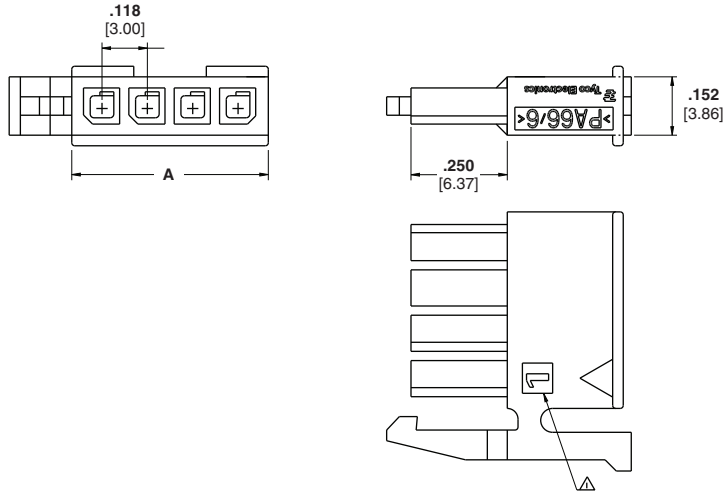

| Positions | Color   | Dimension A | Part Numbers |
|-----------|---------|-------------|--------------|
| 2         | Black   | .276<br>7   | 2029047-2    |
| 3         | Black   | .394<br>10  | 2029047-3    |
| 4         | Black   | .512<br>13  | 2029047-4    |
| 2         | Natural | .276<br>7   | 2029102-2    |
| 3         | Natural | .394<br>10  | 2029102-3    |
| 4         | Natural | .512<br>13  | 2029102-4    |

**Low Profile Right Angle Surface Mount Housings**

**Material**

High Temp Nylon, Black  
Flammability Rating—V0

**Contacts:**

Brass

**Plating A** — .0001100 (.00254)  
minimum tin over .000050 [0.00127]  
minimum nickel

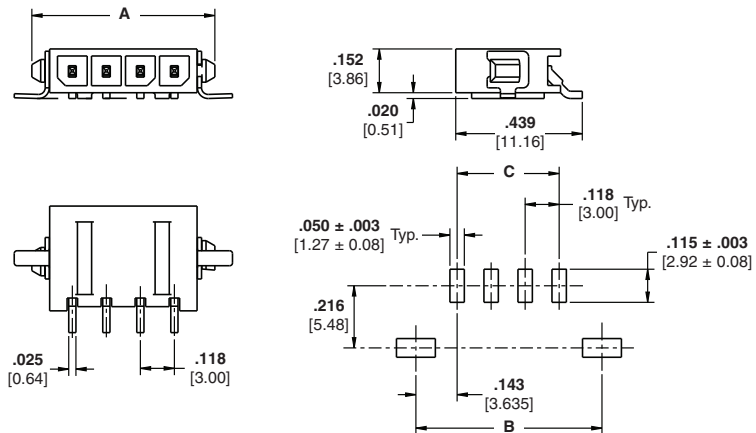

| Positions | Color   | Dimensions |              |           | Part Numbers |
|-----------|---------|------------|--------------|-----------|--------------|
|           |         | A          | B            | C         |              |
| 2         | Black   | .394<br>10 | .410<br>10.4 | .118<br>3 | 2029030-2    |
| 3         | Black   | .512<br>13 | .528<br>13.4 | .263<br>6 | 2029030-3    |
| 4         | Black   | .630<br>16 | .646<br>16.4 | .354<br>9 | 2029030-4    |
| 2         | Natural | .394<br>10 | .410<br>10.4 | .118<br>3 | 2029104-2    |
| 3         | Natural | .512<br>13 | .52<br>13.4  | .263<br>6 | 2029104-3    |
| 4         | Natural | .630<br>16 | .646<br>16.4 | .354<br>9 | 2029104-4    |

**Note:** Less than 4.7mm in vertical board surface height required!

**Micro MATE-N-LOK 3 mm Connector System (Continued)**

**Vertical Header Assemblies**

**Single Row, Through-Hole, with Retention Feature on Soldertail and Polarization Feature to PCB**

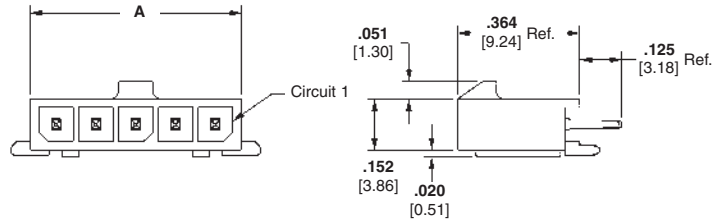

**Material and Finish**

**Housing** — High Temperature Nylon, Black

**Flammability Rating** — UL 94V-0

**Contacts** — Brass

**Plating A**—.000100 [0.00254] min. tin over .000050 [0.00127] min. nickel

**Plating B**—.000015 [0.00038] gold in mating area, .000100 [0.00254] min. tin in solder area, with entire contact underplated .000050 [0.00127] min. nickel

**Plating C**—.000030 [0.00076] gold in mating area, .000100 [0.00254] min. tin in solder area, with entire contact underplated .000050 [0.00127] min. nickel



**Related Product Data**

**Mateable Housings:**

Single Row Receptacle Housings—page 23



**Recommended PC Board Layout\***

| Number of Circuits | Dimensions     |                |                | Header Part Numbers |             |             | Mates with Receptacle Housing Part Number |
|--------------------|----------------|----------------|----------------|---------------------|-------------|-------------|---|
|                    | A              | B              | C              | Plating A           | Plating B   | Plating C   |   |
| 2                  | .276<br>7.00   | .360<br>9.14   | .118<br>3.00   | 2-1445050-2         | 2-1445084-2 | 2-1445093-2 | 1445022-2                                 |
| 3                  | .394<br>10.00  | .478<br>12.14  | .236<br>6.00   | 2-1445050-3         | 2-1445084-3 | 2-1445093-3 | 1445022-3                                 |
| 4                  | .512<br>13.00  | .596<br>15.14  | .354<br>9.00   | 2-1445050-4         | 2-1445084-4 | 2-1445093-4 | 1445022-4                                 |
| 5                  | .630<br>16.00  | .714<br>18.14  | .472<br>12.00  | 2-1445050-5         | 2-1445084-5 | 2-1445093-5 | 1445022-5                                 |
| 6                  | .748<br>19.00  | .832<br>21.14  | .591<br>15.00  | 2-1445050-6         | 2-1445084-6 | 2-1445093-6 | 1445022-6                                 |
| 7                  | .866<br>22.00  | .950<br>24.14  | .709<br>18.00  | 2-1445050-7         | 2-1445084-7 | 2-1445093-7 | 1445022-7                                 |
| 8                  | .984<br>25.00  | 1.069<br>27.14 | .827<br>21.00  | 2-1445050-8         | 2-1445084-8 | 2-1445093-8 | 1445022-8                                 |
| 9                  | 1.102<br>28.00 | 1.187<br>30.14 | .945<br>24.00  | 2-1445050-9         | 2-1445084-9 | 3-1445093-9 | 1445022-9                                 |
| 10                 | 1.220<br>31.00 | 1.304<br>33.14 | 1.063<br>27.00 | 3-1445050-0         | 3-1445084-0 | 3-1445093-0 | 1-1445022-0                               |
| 11                 | 1.339<br>34.00 | 1.423<br>36.14 | 1.181<br>30.00 | 3-1445050-1         | 3-1445084-1 | 3-1445093-1 | 1-1445022-1                               |
| 12                 | 1.457<br>37.00 | 1.541<br>39.14 | 1.299<br>33.00 | 3-1445050-2         | 3-1445084-2 | 3-1445093-2 | 1-1445022-2                               |

\*Recommended PC Board thickness .062 [1.57]. Always consult customer drawing for PC Board layout dimensions.

**Note:** All part numbers are RoHS Compliant.

**Micro MATE-N-LOK 3 mm Connector System (Continued)**

**Vertical Header Assemblies**

(Continued)

**Single Row, Through-Hole, with Metal Through-Hole Hold-down**

**Material and Finish**

**Housing** — High Temperature Nylon, Black

**Flammability Rating** — UL 94V-0

**Contacts** — Brass

**Plating A** — .000100 [0.00254] min. tin over .000050 [0.00127] min. nickel

**Plating B** — .000015 [0.00038] gold in mating area, .000100 [0.00254] min. tin in solder area, with entire contact underplated .000050 [0.00127] min. nickel

**Plating C** — .000030 [0.00076] gold in mating area, .000100 [0.00254] min. tin in solder area, with entire contact underplated .000050 [0.00127] min. nickel

**Hold-downs** — Phosphor Bronze, .000100 [0.00254] min. tin over .000050 [0.00127] min. nickel

**Related Product Data**

**Mateable Housings:**

Single Row Receptacle Housing— page 23



**Recommended PC Board Layout\***

| Number of Circuits | Dimensions     |                |                | Header Part Numbers |             |             | Mates with Receptacle Housing Part Number |
|--------------------|----------------|----------------|----------------|---------------------|-------------|-------------|---|
|                    | A              | B              | C              | Plating A           | Plating B   | Plating C   |   |
| 2                  | .399<br>10.14  | .293<br>7.43   | .118<br>3.00   | 2-1445051-2         | 2-1445085-2 | 2-1445094-2 | 1445022-2                                 |
| 3                  | .517<br>13.14  | .411<br>10.43  | .236<br>6.00   | 2-1445051-3         | 2-1445085-3 | 2-1445094-3 | 1445022-3                                 |
| 4                  | .635<br>16.14  | .529<br>13.43  | .354<br>9.00   | 2-1445051-4         | 2-1445085-4 | 2-1445094-4 | 1445022-4                                 |
| 5                  | .754<br>19.14  | .647<br>16.43  | .472<br>12.00  | 2-1445051-5         | 2-1445085-5 | 2-1445094-5 | 1445022-5                                 |
| 6                  | .871<br>22.14  | .765<br>19.43  | .591<br>15.00  | 2-1445051-6         | 2-1445085-6 | 2-1445094-6 | 1445022-6                                 |
| 7                  | .990<br>25.14  | .883<br>22.43  | .709<br>18.00  | 2-1445051-7         | 2-1445085-7 | 2-1445094-7 | 1445022-7                                 |
| 8                  | 1.108<br>28.14 | 1.001<br>25.43 | .827<br>21.00  | 2-1445051-8         | 2-1445085-8 | 2-1445094-8 | 1445022-8                                 |
| 9                  | 1.226<br>31.14 | 1.119<br>28.43 | .945<br>24.00  | 2-1445051-9         | 2-1445085-9 | 2-1445094-9 | 1445022-9                                 |
| 10                 | 1.344<br>34.14 | 1.237<br>31.43 | 1.063<br>27.00 | 3-1445051-0         | 3-1445085-0 | 3-1445094-0 | 1-1445022-0                               |
| 11                 | 1.462<br>37.14 | 1.356<br>34.43 | 1.181<br>30.00 | 3-1445051-1         | 3-1445085-1 | 3-1445094-1 | 1-1445022-1                               |
| 12                 | 1.580<br>40.14 | 1.474<br>37.43 | 1.299<br>33.00 | 3-1445051-2         | 3-1445085-2 | 3-1445094-2 | 1-1445022-2                               |

\*Recommended PC Board thickness .062 [1.57]. Always consult customer drawing for PC Board layout dimensions.

**Note:** All part numbers are RoHS Compliant.

**Micro MATE-N-LOK 3 mm Connector System (Continued)**

**Vertical Header Assemblies**

(Continued)

**Single Row, Surface Mount, with Metal Through-Hole Hold-down**

**Material and Finish**

**Housing** — High Temperature Nylon, Black

**Flammability Rating** — UL 94V-0

**Contacts**—Brass

**Plating A**—.000100 [0.00254] min. tin over .000050 [0.00127] min. nickel

**Plating B**—.000015 [0.00038] gold in mating area, .000100 [0.00254] min. tin in solder area, with entire contact underplated .000050 [0.00127] min. nickel

**Plating C**—.000030 [0.00076] gold in mating area, .000100 [0.00254] min. tin in solder area, with entire contact underplated .000050 [0.00127] min. nickel

**Hold-downs**—Phosphor Bronze, .000100 [0.00254] min. tin over .000050 [0.00127] min. nickel

**Related Product Data**

**Mateable Housings:**

Single Row Receptacle Housing—page 23



**Recommended PC Board Layout\***

| Number of Circuits | Dimensions     |                |                | Header Part Numbers |             |             | Mates with Receptacle Housing Part Number |
|--------------------|----------------|----------------|----------------|---------------------|-------------|-------------|---|
|                    | A              | B              | C              | Plating A           | Plating B   | Plating C   |   |
| 2                  | .394<br>10.00  | .293<br>7.43   | .118<br>3.00   | 2-1445052-2         | 2-1445086-2 | 2-1445095-2 | 1445022-2                                 |
| 3                  | .512<br>13.00  | .411<br>10.43  | .236<br>6.00   | 2-1445052-3         | 2-1445086-3 | 2-1445095-3 | 1445022-3                                 |
| 4                  | .630<br>16.00  | .529<br>13.43  | .354<br>9.00   | 2-1445052-4         | 2-1445086-4 | 2-1445095-4 | 1445022-4                                 |
| 5                  | .748<br>19.00  | .647<br>16.43  | .472<br>12.00  | 2-1445052-5         | 2-1445086-5 | 2-1445095-5 | 1445022-5                                 |
| 6                  | .866<br>22.00  | .765<br>19.43  | .591<br>15.00  | 2-1445052-6         | 2-1445086-6 | 2-1445095-6 | 1445022-6                                 |
| 7                  | .984<br>25.00  | .883<br>22.43  | .709<br>18.00  | 2-1445052-7         | 2-1445086-7 | 2-1445095-7 | 1445022-7                                 |
| 8                  | 1.102<br>28.00 | 1.001<br>25.43 | .827<br>21.00  | 2-1445052-8         | 2-1445086-8 | 2-1445095-8 | 1445022-8                                 |
| 9                  | 1.220<br>31.00 | 1.119<br>28.43 | .945<br>24.00  | 2-1445052-9         | 2-1445086-9 | 2-1445095-9 | 1445022-9                                 |
| 10                 | 1.339<br>34.00 | 1.237<br>31.43 | 1.063<br>27.00 | 3-1445052-0         | 3-1445086-0 | 3-1445095-0 | 1-1445022-0                               |
| 11                 | 1.457<br>37.00 | 1.356<br>34.43 | 1.181<br>30.00 | 3-1445052-1         | 3-1445086-1 | 3-1445095-1 | 1-1445022-1                               |
| 12                 | 1.575<br>40.00 | 1.474<br>37.43 | 1.299<br>33.00 | 3-1445052-2         | 3-1445086-2 | 3-1445095-2 | 1-1445022-2                               |

\*Recommended PC Board thickness .062 [1.57]. Always consult customer drawing for PC Board layout dimensions.

**Note:** All part numbers are RoHS Compliant.



**Micro MATE-N-LOK 3 mm Connector System (Continued)**

**Vertical Header Assemblies**

(Continued)

**Single Row, Surface Mount, with Surface Mount Hold-down**

**Material and Finish**

**Housing** — High Temperature Nylon, Black

**Flammability Rating** — UL 94V-0

**Contacts**—Brass

**Plating A**— .000100 [0.00254] min. tin over .000050 [0.00127] min. nickel

**Plating B**— .000015 [0.00038] gold in mating area, .000100 [0.00254] min. tin in solder area, with entire contact underplated .000050 [0.00127] min. nickel

**Plating C**— .000030 [0.00076] gold in mating area, .000100 [0.00254] min. tin in solder area, with entire contact underplated .000050 [0.00127] min. nickel

**Hold-downs**—Phosphor Bronze, .000100 [0.00254] min. tin over .000050 [0.00127] min. nickel

**Related Product Data**

**Mateable Housings:**

Single Row Receptacle Housing— page 23

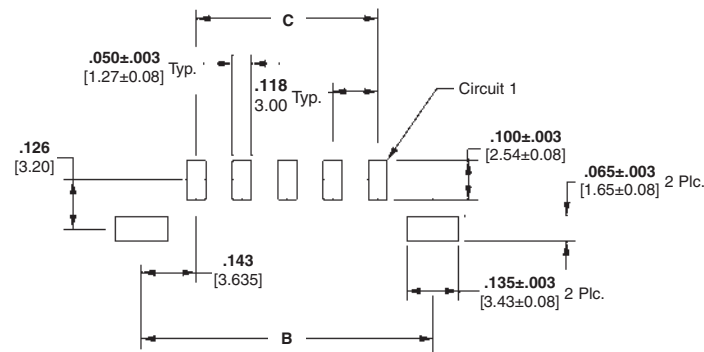
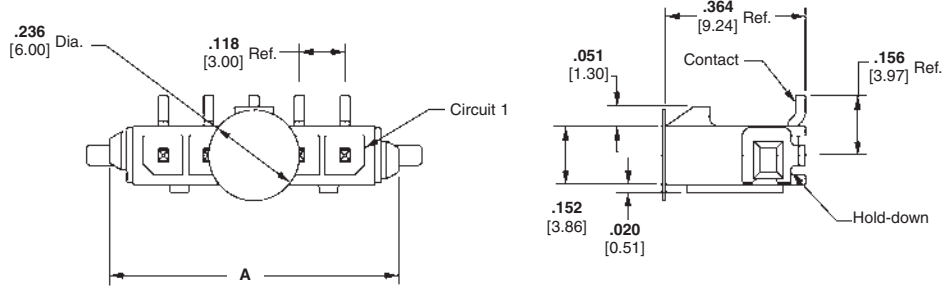

**Recommended PC Board Layout\***

| Number of Circuits | Dimensions     |                |                | Header Part Numbers |             |             | Mates with Receptacle Housing Part Number |
|--------------------|----------------|----------------|----------------|---------------------|-------------|-------------|---|
|                    | A              | B              | C              | Plating A           | Plating B   | Plating C   |   |
| 2                  | .394<br>10.00  | .410<br>10.41  | .118<br>3.00   | 2-1445053-2         | 2-1445087-2 | 2-1445096-2 | 1445022-2                                 |
| 3                  | .512<br>13.00  | .528<br>13.41  | .236<br>6.00   | 2-1445053-3         | 2-1445087-3 | 2-1445096-3 | 1445022-3                                 |
| 4                  | .630<br>16.00  | .646<br>16.41  | .354<br>9.00   | 2-1445053-4         | 2-1445087-4 | 2-1445096-4 | 1445022-4                                 |
| 5                  | .748<br>19.00  | .765<br>19.41  | .472<br>12.00  | 2-1445053-5         | 2-1445087-5 | 2-1445096-5 | 1445022-5                                 |
| 6                  | .866<br>22.00  | .882<br>22.41  | .591<br>15.00  | 2-1445053-6         | 2-1445087-6 | 2-1445096-6 | 1445022-6                                 |
| 7                  | .984<br>25.00  | 1.001<br>25.41 | .709<br>18.00  | 2-1445053-7         | 2-1445087-7 | 2-1445096-7 | 1445022-7                                 |
| 8                  | 1.102<br>28.00 | 1.119<br>28.41 | .827<br>21.00  | 2-1445053-8         | 2-1445087-8 | 2-1445096-8 | 1445022-8                                 |
| 9                  | 1.220<br>31.00 | 1.237<br>31.41 | .945<br>24.00  | 2-1445053-9         | 2-1445087-9 | 2-1445096-9 | 1445022-9                                 |
| 10                 | 1.339<br>34.00 | 1.355<br>34.41 | 1.063<br>27.00 | 3-1445053-0         | 3-1445087-0 | 3-1445096-0 | 1-1445022-0                               |
| 11                 | 1.457<br>37.00 | 1.473<br>37.41 | 1.181<br>30.00 | 3-1445053-1         | 3-1445087-1 | 3-1445096-1 | 1-1445022-1                               |
| 12                 | 1.575<br>40.00 | 1.591<br>40.41 | 1.299<br>33.00 | 3-1445053-2         | 3-1445087-2 | 3-1445096-2 | 1-1445022-2                               |

\*Always consult customer drawing for PC Board layout dimensions.

**Note:** All part numbers are RoHS Compliant.

**Micro MATE-N-LOK 3 mm Connector System (Continued)**

**Vertical Header Assemblies**

(Continued)

**Dual Row, Through-Hole, with Retention Feature on Solder Tail**

**Material and Finish**

**Housing** — High Temperature Nylon, Black

**Flammability Rating** — UL 94V-0

**Contacts**—Brass

**Plating A**— .000100 [0.00254] min. tin over .000050 [0.00127] min. nickel

**Plating B**— .000015 [0.00038] gold in mating area, .000100 [0.00254] min. tin in solder area, with entire contact underplated .000050 [0.00127] min. nickel

**Plating C**— .000030 [0.00076] gold in mating area, .000100 [0.00254] min. tin in solder area, with entire contact underplated .000050 [0.00127] min. nickel

**Hold-downs**—Phosphor Bronze, .000100 [0.00254] min. tin over .000050 [0.00127] min. nickel

**Related Product Data**

**Mateable Housings:**

Dual Row Receptacle Housing—page 24

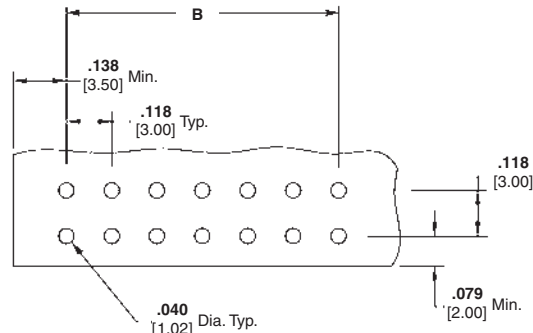

**Recommended PC Board Layout\***

| Number of Circuits | Dimensions     |                | Header Part Numbers |            |            | Mates with Receptacle Housing Part Number |
|--------------------|----------------|----------------|---------------------|------------|------------|---|
|                    | A              | B              | Plating A           | Plating B  | Plating C  |   |
| 2                  | .276<br>7.00   | —              | 3-794630-2          | 3-794631-2 | 3-794632-2 | 794617-2                                  |
| 4                  | .394<br>10.00  | .118<br>3.00   | 3-794630-4          | 3-794631-4 | 3-794632-4 | 794617-4                                  |
| 6                  | .512<br>13.00  | .236<br>6.00   | 3-794630-6          | 3-794631-6 | 3-794632-6 | 794617-6                                  |
| 8                  | .630<br>16.00  | .354<br>9.00   | 3-794630-8          | 3-794631-8 | 3-794632-8 | 794617-8                                  |
| 10                 | .748<br>19.00  | .472<br>12.00  | 4-794630-0          | 4-794631-0 | 4-794632-0 | 1-794617-0                                |
| 12                 | .866<br>22.00  | .591<br>15.00  | 4-794630-2          | 4-794631-2 | 4-794632-2 | 1-794617-2                                |
| 14                 | .984<br>25.00  | .709<br>18.00  | 4-794630-4          | 4-794631-4 | 4-794632-4 | 1-794617-4                                |
| 16                 | 1.102<br>28.00 | .827<br>21.00  | 4-794630-6          | 4-794631-6 | 4-794632-6 | 1-794617-6                                |
| 18                 | 1.220<br>31.00 | .945<br>24.00  | 4-794630-8          | 4-794631-8 | 4-794632-8 | 1-794617-8                                |
| 20                 | 1.339<br>34.00 | 1.063<br>27.00 | 5-794630-0          | 5-794631-0 | 5-794632-0 | 2-794617-0                                |
| 22                 | 1.457<br>37.00 | 1.181<br>30.00 | 5-794630-2          | 5-794631-2 | 5-794632-2 | 2-794617-2                                |
| 24                 | 1.575<br>40.00 | 1.299<br>33.00 | 5-794630-4          | 5-794631-4 | 5-794632-4 | 2-794617-4                                |

\*Recommended PC Board thickness .062 [1.57]. Always consult customer drawing for PC Board layout dimensions.

**Note: All part numbers are RoHS Compliant.**

**Micro MATE-N-LOK 3 mm Connector System (Continued)**

**Vertical Header Assemblies**

(Continued)

**Dual Row, Through-Hole, with Retention Feature on Soldertail and Metal Through-Hole Hold-down**

**Material and Finish**

**Housing**—High Temperature Nylon, Black

**Flammability Rating**—UL 94V-0

**Contacts**—Brass

**Plating A**— .000100 [0.00254] min. tin over .000050 [0.00127] min. nickel

**Plating B**— .000015 [0.00038] gold in mating area, .000100 [0.00254] min. tin in solder area, with entire contact underplated .000050 [0.00127] min. nickel

**Plating C**— .000030 [0.00076] gold in mating area, .000100 [0.00254] min. tin in solder area, with entire contact underplated .000050 [0.00127] min. nickel

**Hold-downs**—Phosphor Bronze, .000100 [0.00254] min. tin over .000050 [0.00127] min. nickel

**Related Product Data**

**Mateable Housings:**

Dual Row Receptacle Housing—page 24



**Section Z-Z**

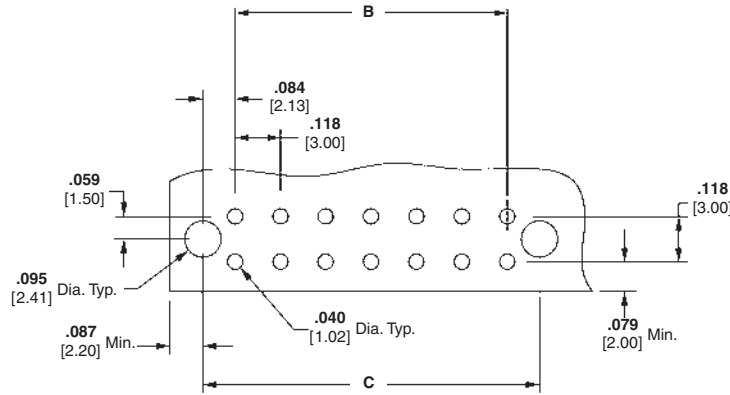
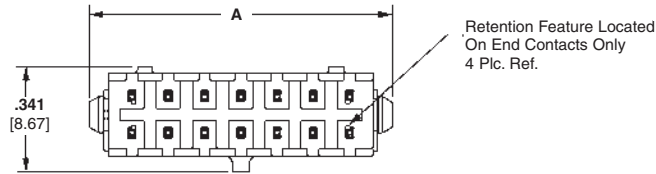

**Recommended PC Board Layout\***

| Number of Circuits | Dimensions     |                |                | Header Part Numbers |            |            | Mates with Receptacle Housing Part Number |
|--------------------|----------------|----------------|----------------|---------------------|------------|------------|---|
|                    | A              | B              | C              | Plating A           | Plating B  | Plating C  |   |
| 2                  | .276<br>7.00   | —              | .169<br>4.30   | 3-794680-2          | 3-794681-2 | 3-794682-2 | 794617-2                                  |
| 4                  | .394<br>10.00  | .118<br>3.00   | .287<br>7.30   | 3-794680-4          | 3-794681-4 | 3-794682-4 | 794617-4                                  |
| 6                  | .512<br>13.00  | .236<br>6.00   | .406<br>10.30  | 3-794680-6          | 3-794681-6 | 3-794682-6 | 794617-6                                  |
| 8                  | .630<br>16.00  | .354<br>9.00   | .524<br>13.30  | 3-794680-8          | 3-794681-8 | 3-794682-8 | 794617-8                                  |
| 10                 | .748<br>19.00  | .472<br>12.00  | .642<br>16.30  | 4-794680-0          | 4-794681-0 | 4-794682-0 | 1-794617-0                                |
| 12                 | .866<br>22.00  | .591<br>15.00  | .760<br>19.30  | 4-794680-2          | 4-794681-2 | 4-794682-2 | 1-794617-2                                |
| 14                 | .984<br>25.00  | .709<br>18.00  | .878<br>22.30  | 4-794680-4          | 4-794681-4 | 4-794682-4 | 1-794617-4                                |
| 16                 | 1.102<br>28.00 | .827<br>21.00  | .996<br>25.30  | 4-794680-6          | 4-794681-6 | 4-794682-6 | 1-794617-6                                |
| 18                 | 1.220<br>31.00 | .945<br>24.00  | 1.114<br>28.30 | 4-794680-8          | 4-794681-8 | 4-794682-8 | 1-794617-8                                |
| 20                 | 1.339<br>34.00 | 1.063<br>27.00 | 1.232<br>31.30 | 5-794680-0          | 5-794681-0 | 5-794682-0 | 2-794617-0                                |
| 22                 | 1.457<br>37.00 | 1.181<br>30.00 | 1.350<br>34.30 | 5-794680-2          | 5-794681-2 | 5-794682-2 | 2-794617-2                                |
| 24                 | 1.575<br>40.00 | 1.299<br>33.00 | 1.469<br>37.30 | 5-794680-4          | 5-794681-4 | 5-794682-4 | 2-794617-4                                |

\*Recommended PC Board thickness .062 [1.57]. Always consult customer drawing for PC Board layout dimensions.

**Note: All part numbers are RoHS Compliant.**

**Micro MATE-N-LOK 3 mm Connector System (Continued)**

**Vertical Header Assemblies**

(Continued)

**Dual Row, Surface Mount, with Metal Through-Hole Hold-down**

**Material and Finish**

**Housing**—High Temperature Nylon, Black

**Flammability Rating**—UL 94V-0

**Contacts**—Brass

**Plating A**—.000100 [0.00254] min. tin over .000050 [0.00127] min. nickel

**Plating B**—.000015 [0.00038] gold in mating area, .000100 [0.00254] min. tin in solder area, with entire contact underplated .000050 [0.00127] min. nickel

**Plating C**—.000030 [0.00076] gold in mating area, .000100 [0.00254] min. tin in solder area, with entire contact underplated .000050 [0.00127] min. nickel

**Hold-downs**—Phosphor Bronze, .000100 [0.00254] min. tin over .000050 [0.00127] min. nickel

**Pick-up Button**—Kapton

**Related Product Data**

**Mateable Housings:**

Dual Row Receptacle Housing—page 24



**Recommended PC Board Layout\***

| Number of Circuits | Dimensions     |                |                | Header Part Numbers |            |            | Mates with Receptacle Housing Part Number |
|--------------------|----------------|----------------|----------------|---------------------|------------|------------|---|
|                    | A              | B              | C              | Plating A           | Plating B  | Plating C  |   |
| 2                  | .276<br>7.00   | —              | .169<br>4.30   | 3-794633-2          | 3-794634-2 | 3-794635-2 | 794617-2                                  |
| 4                  | .394<br>10.00  | .118<br>3.00   | .287<br>7.30   | 3-794633-4          | 3-794634-4 | 3-794635-4 | 794617-4                                  |
| 6                  | .512<br>13.00  | .236<br>6.00   | .406<br>10.30  | 3-794633-6          | 3-794634-6 | 3-794635-6 | 794617-6                                  |
| 8                  | .630<br>16.00  | .354<br>9.00   | .524<br>13.30  | 3-794633-8          | 3-794634-8 | 3-794635-8 | 794617-8                                  |
| 10                 | .748<br>19.00  | .472<br>12.00  | .642<br>16.30  | 4-794633-0          | 4-794634-0 | 4-794635-0 | 1-794617-0                                |
| 12                 | .866<br>22.00  | .591<br>15.00  | .760<br>19.30  | 4-794633-2          | 4-794634-2 | 4-794635-2 | 1-794617-2                                |
| 14                 | .984<br>25.00  | .709<br>18.00  | .878<br>22.30  | 4-794633-4          | 4-794634-4 | 4-794635-4 | 1-794617-4                                |
| 16                 | 1.10<br>28.00  | 2.827<br>21.00 | .996<br>25.30  | 4-794633-6          | 4-794634-6 | 4-794635-6 | 1-794617-6                                |
| 18                 | 1.220<br>31.00 | 0.945<br>24.00 | 1.114<br>28.30 | 4-794633-8          | 4-794634-8 | 4-794635-8 | 1-794617-8                                |
| 20                 | 1.339<br>34.00 | 1.063<br>27.00 | 1.232<br>31.30 | 5-794633-0          | 5-794634-0 | 5-794635-0 | 2-794617-0                                |
| 22                 | 1.457<br>37.00 | 1.181<br>30.00 | 1.350<br>34.30 | 5-794633-2          | 5-794634-2 | 5-794635-2 | 2-794617-2                                |
| 24                 | 1.575<br>40.00 | 1.299<br>33.00 | 1.469<br>37.30 | 5-794633-4          | 5-794634-4 | 5-794635-4 | 2-794617-4                                |

\*Recommended PC Board thickness .062 [1.57]. Always consult customer drawing for PC Board layout dimensions.

**Note: All part numbers are RoHS Compliant.**

**Micro MATE-N-LOK 3 mm Connector System (Continued)**

**Vertical Header Assemblies**

(Continued)

**Dual Row, Surface Mount, with Surface Mount Hold-down**

**Material and Finish**

**Housing** — High Temperature Nylon, Black

**Flammability Rating** — UL 94V-0

**Contacts** — Brass

**Plating A** — .000100 [0.00254] min. tin over .000050 [0.00127] min. nickel

**Plating B** — .000015 [0.00038] gold in mating area, .000100 [0.00254] min. tin in solder area, with entire contact underplated .000050 [0.00127] min. nickel

**Plating C** — .000030 [0.00076] gold in mating area, .000100 [0.00254] min. tin in solder area, with entire contact underplated .000050 [0.00127] min. nickel

**Hold-downs** — Phosphor Bronze, .000100 [0.00254] min. tin over .000050 [0.00127] min. nickel

**Pick-up Button** — Kapton

**Related Product Data**

**Mateable Housings:**

Dual Row Receptacle Housing—page 24

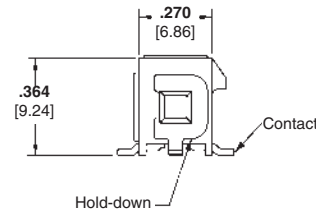

**Recommended PC Board Layout\***

| Number of Circuits | Dimensions     |                |                | Header Part Numbers |            |            | Mates with Receptacle Housing Part Number |
|--------------------|----------------|----------------|----------------|---------------------|------------|------------|---|
|                    | A              | B              | C              | Plating A           | Plating B  | Plating C  |   |
| 2                  | .276<br>7.00   | —              | .286<br>7.27   | 3-794636-2          | 3-794637-2 | 3-794638-2 | 794617-2                                  |
| 4                  | .394<br>10.00  | .118<br>3.00   | .404<br>10.27  | 3-794636-4          | 3-794637-4 | 3-794638-4 | 794617-4                                  |
| 6                  | .512<br>13.00  | .236<br>6.00   | .522<br>13.27  | 3-794636-6          | 3-794637-6 | 3-794638-6 | 794617-6                                  |
| 8                  | .630<br>16.00  | .354<br>9.00   | .640<br>16.27  | 3-794636-8          | 3-794637-8 | 3-794638-8 | 794617-8                                  |
| 10                 | .748<br>19.00  | .472<br>12.00  | .758<br>19.27  | 4-794636-0          | 4-794637-0 | 4-794638-0 | 1-794617-0                                |
| 12                 | .866<br>22.00  | .591<br>15.00  | .876<br>22.27  | 4-794636-2          | 4-794637-2 | 4-794638-2 | 1-794617-2                                |
| 14                 | .984<br>25.00  | .709<br>18.00  | .994<br>25.27  | 4-794636-4          | 4-794637-4 | 4-794638-4 | 1-794617-4                                |
| 16                 | 1.102<br>28.00 | .827<br>21.00  | 1.112<br>28.27 | 4-794636-6          | 4-794637-6 | 4-794638-6 | 1-794617-6                                |
| 18                 | 1.220<br>31.00 | .945<br>24.00  | 1.230<br>31.27 | 4-794636-8          | 4-794637-8 | 4-794638-8 | 1-794617-8                                |
| 20                 | 1.339<br>34.00 | 1.063<br>27.00 | 1.349<br>34.27 | 5-794636-0          | 5-794637-0 | 5-794638-0 | 2-794617-0                                |
| 22                 | 1.457<br>37.00 | 1.181<br>30.00 | 1.467<br>37.27 | 5-794636-2          | 5-794637-2 | 5-794638-2 | 2-794617-2                                |
| 24                 | 1.575<br>40.00 | 1.299<br>33.00 | 1.585<br>40.27 | 5-794636-4          | 5-794637-4 | 5-794638-4 | 2-794617-4                                |

\*Always consult customer drawing for PC Board layout dimensions.

**Note:** All part numbers are RoHS Compliant.

**Micro MATE-N-LOK 3 mm Connector System (Continued)**

**Right-Angle Header Assemblies**

**Single Row, Through-Hole, with Metal Through-Hole Hold-down**

**Material and Finish**

**Housing**—High Temperature Nylon, Black

**Flammability Rating**—UL 94V-0

**Contacts**—Brass

**Plating A**— $.000100$  [0.00254] min. tin over  $.000050$  [0.00127] min. nickel

**Plating B**— $.000015$  [0.00038] gold in mating area,  $.000100$  [0.00254] min. tin in solder area, with entire contact underplated  $.000050$  [0.00127] min. nickel

**Plating C**— $.000030$  [0.00076] gold in mating area,  $.000100$  [0.00254] min. tin in solder area, with entire contact underplated  $.000050$  [0.00127] min. nickel

**Hold-downs**—Phosphor Bronze,  $.000100$  [0.00254] min. tin over  $.000050$  [0.00127] min. nickel

**Related Product Data**

**Mateable Housings:**

Single Row Receptacle Housing—  
page 23



**Recommended PC Board Layout\***

| Number of Circuits | Dimensions     |                |                | Header Part Numbers |             |             | Mates with Receptacle Housing Part Number |
|--------------------|----------------|----------------|----------------|---------------------|-------------|-------------|---|
|                    | A              | B              | C              | Plating A           | Plating B   | Plating C   |   |
| 2                  | .399<br>10.14  | .293<br>7.43   | .118<br>3.00   | 2-1445054-2         | 2-1445088-2 | 2-1445097-2 | 1445022-2                                 |
| 3                  | .517<br>13.14  | .411<br>10.43  | .236<br>6.00   | 2-1445054-3         | 2-1445088-3 | 2-1445097-3 | 1445022-3                                 |
| 4                  | .635<br>16.14  | .529<br>13.43  | .354<br>9.00   | 2-1445054-4         | 2-1445088-4 | 2-1445097-4 | 1445022-4                                 |
| 5                  | .754<br>19.14  | .647<br>16.43  | .472<br>12.00  | 2-1445054-5         | 2-1445088-5 | 2-1445097-5 | 1445022-5                                 |
| 6                  | .871<br>22.14  | .765<br>19.43  | .591<br>15.00  | 2-1445054-6         | 2-1445088-6 | 2-1445097-6 | 1445022-6                                 |
| 7                  | .990<br>25.14  | .883<br>22.43  | .709<br>18.00  | 2-1445054-7         | 2-1445088-7 | 2-1445097-7 | 1445022-7                                 |
| 8                  | 1.108<br>28.14 | 1.001<br>25.43 | .827<br>21.00  | 2-1445054-8         | 2-1445088-8 | 2-1445097-8 | 1445022-8                                 |
| 9                  | 1.226<br>31.14 | 1.119<br>28.43 | .945<br>24.00  | 2-1445054-9         | 2-1445088-9 | 2-1445097-9 | 1445022-9                                 |
| 10                 | 1.344<br>34.14 | 1.237<br>31.43 | 1.063<br>27.00 | 3-1445054-0         | 3-1445088-0 | 3-1445097-0 | 1-1445022-0                               |
| 11                 | 1.462<br>37.14 | 1.356<br>34.43 | 1.181<br>30.00 | 3-1445054-1         | 3-1445088-1 | 3-1445097-1 | 1-1445022-1                               |
| 12                 | 1.580<br>40.14 | 1.474<br>37.43 | 1.299<br>33.00 | 3-1445054-2         | 3-1445088-2 | 3-1445097-2 | 1-1445022-2                               |

\*Recommended PC Board thickness  $.062$  [1.57]. Always consult customer drawing for PC Board layout dimensions.

**Note:** All part numbers are RoHS Compliant.

**Micro MATE-N-LOK 3 mm Connector System (Continued)**

High Density

Micro MATE-N-LOK 3 mm Connector System  
.118 [3.00] Centerline

**Right-Angle Header Assemblies (Continued)**

**Single Row, Through-Hole, with Plastic Boardlock**

**Material and Finish**

**Housing** — High Temperature Nylon, Black

**Flammability Rating** — UL 94V-0

**Contacts**—Brass

**Plating A**— .000100 [0.00254] min. tin over .000050 [0.00127] min. nickel

**Plating B**— .000015 [0.00038] gold in mating area, .000100 [0.00254] min. tin in solder area, with entire contact underplated .000050 [0.00127] min. nickel

**Plating C**— .000030 [0.00076] gold in mating area, .000100 [0.00254] min. tin in solder area, with entire contact underplated .000050 [0.00127] min. nickel



**Related Product Data**

**Mateable Housings:**

Single Row Receptacle Housing— page 23

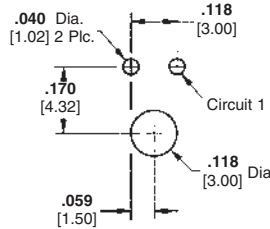

**Recommended PC Board Layout 2 Position\***

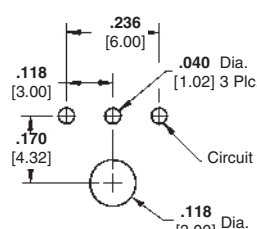

**Recommended PC Board Layout 3 Position\***

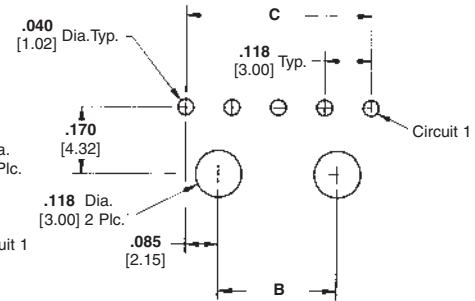

**Recommended PC Board Layout 4-12 Position\***

| Number of Circuits | Dimensions     |                |                | Header Part Numbers |             |             | Mates with Receptacle Housing Part Number |
|--------------------|----------------|----------------|----------------|---------------------|-------------|-------------|---|
|                    | A              | B              | C              | Plating A           | Plating B   | Plating C   |   |
| 2                  | .399<br>10.14  | —              | —              | 2-1445055-2         | 2-1445089-2 | 2-1445098-2 | 1445022-2                                 |
| 3                  | .517<br>13.14  | —              | —              | 2-1445055-3         | 2-1445089-3 | 2-1445098-3 | 1445022-3                                 |
| 4                  | .635<br>16.14  | .185<br>4.70   | .354<br>9.00   | 2-1445055-4         | 2-1445089-4 | 2-1445098-4 | 1445022-4                                 |
| 5                  | .754<br>19.14  | .303<br>7.70   | .472<br>12.00  | 2-1445055-5         | 2-1445089-5 | 2-1445098-5 | 1445022-5                                 |
| 6                  | .871<br>22.14  | .421<br>10.70  | .591<br>15.00  | 2-1445055-6         | 2-1445089-6 | 2-1445098-6 | 1445022-6                                 |
| 7                  | .990<br>25.14  | .539<br>13.70  | .709<br>18.00  | 2-1445055-7         | 2-1445089-7 | 2-1445098-7 | 1445022-7                                 |
| 8                  | 1.108<br>28.14 | .657<br>16.70  | .827<br>21.00  | 2-1445055-8         | 2-1445089-8 | 2-1445098-8 | 1445022-8                                 |
| 9                  | 1.226<br>31.14 | .775<br>19.70  | .945<br>24.00  | 2-1445055-9         | 2-1445089-9 | 2-1445098-9 | 1445022-9                                 |
| 10                 | 1.344<br>34.14 | .894<br>22.70  | 1.063<br>27.00 | 3-1445055-0         | 3-1445089-0 | 3-1445098-0 | 1-1445022-0                               |
| 11                 | 1.462<br>37.14 | 1.012<br>25.70 | 1.181<br>30.00 | 3-1445055-1         | 3-1445089-1 | 3-1445098-1 | 1-1445022-1                               |
| 12                 | 1.580<br>40.14 | 1.300<br>28.70 | 1.299<br>33.00 | 3-1445055-2         | 3-1445089-2 | 3-1445098-2 | 1-1445022-2                               |

\*Recommended PC Board thickness .062 [1.57]. Always consult customer drawing for PC Board layout dimensions.

**Note: All part numbers are RoHS Compliant.**

**Micro MATE-N-LOK 3 mm Connector System (Continued)**

**Right-Angle Header Assemblies (Continued)**

**Single Row, Surface Mount, with Metal Through-Hole Hold-down**

**Material and Finish**

**Housing** — High Temperature Nylon, Black

**Flammability Rating** — UL 94V-0

**Contacts** — Brass

**Plating A** — .000100 [0.00254] min. tin over .000050 [0.00127] min. nickel

**Plating B** — .000015 [0.00038] gold in mating area, .000100 [0.00254] min. tin in solder area, with entire contact underplated .000050 [0.00127] min. nickel

**Plating C** — .000030 [0.00076] gold in mating area, .000100 [0.00254] min. tin in solder area, with entire contact underplated .000050 [0.00127] min. nickel

**Hold-downs** — Phosphor Bronze, .000100 [0.00254] min. tin over .000050 [0.00127] min. nickel

**Related Product Data**

**Mateable Housings:**

Single Row Receptacle Housing—  
page 23

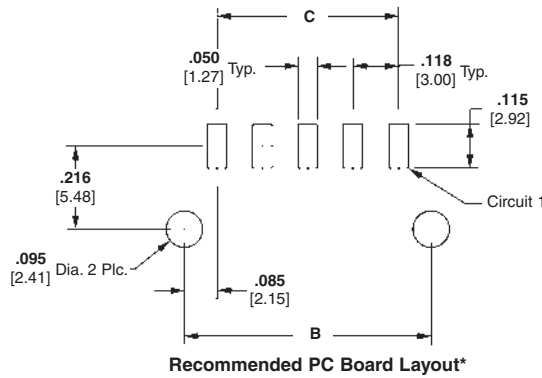

| Number of Circuits | Dimensions     |                |                | Header Part Numbers |             |             | Mates with Receptacle Housing Part Number |
|--------------------|----------------|----------------|----------------|---------------------|-------------|-------------|---|
|                    | A              | B              | C              | Plating A           | Plating B   | Plating C   |   |
| 2                  | .394<br>10.00  | .293<br>7.43   | .118<br>3.00   | 2-1445056-2         | 2-1445090-2 | 2-1445099-2 | 1445022-2                                 |
| 3                  | .512<br>13.00  | .411<br>10.43  | .236<br>6.00   | 2-1445056-3         | 2-1445090-3 | 2-1445099-3 | 1445022-3                                 |
| 4                  | .630<br>16.00  | .529<br>13.43  | .354<br>9.00   | 2-1445056-4         | 2-1445090-4 | 2-1445099-4 | 1445022-4                                 |
| 5                  | .748<br>19.00  | .647<br>16.43  | .472<br>12.00  | 2-1445056-5         | 2-1445090-5 | 2-1445099-5 | 1445022-5                                 |
| 6                  | .866<br>22.00  | .765<br>19.43  | .591<br>15.00  | 2-1445056-6         | 2-1445090-6 | 2-1445099-6 | 1445022-6                                 |
| 7                  | .984<br>25.00  | .883<br>22.43  | .709<br>18.00  | 2-1445056-7         | 2-1445090-7 | 2-1445099-7 | 1445022-7                                 |
| 8                  | 1.102<br>28.00 | 1.001<br>25.43 | .827<br>21.00  | 2-1445056-8         | 2-1445090-8 | 2-1445099-8 | 1445022-8                                 |
| 9                  | 1.220<br>31.00 | 1.119<br>28.43 | 0.945<br>24.00 | 2-1445056-9         | 2-1445090-9 | 2-1445099-9 | 1445022-9                                 |
| 10                 | 1.339<br>34.00 | 1.237<br>31.43 | 1.063<br>27.00 | 3-1445056-0         | 3-1445090-0 | 3-1445099-0 | 1-1445022-0                               |
| 11                 | 1.457<br>37.00 | 1.356<br>34.43 | 1.181<br>30.00 | 3-1445056-1         | 3-1445090-1 | 3-1445099-1 | 1-1445022-1                               |
| 12                 | 1.575<br>40.00 | 1.474<br>37.43 | 1.299<br>33.00 | 3-1445056-2         | 3-1445090-2 | 3-1445099-2 | 1-1445022-2                               |

\*Recommended PC Board thickness .062 [1.57]. Always consult customer drawing for PC Board layout dimensions.

**Note:** All part numbers are RoHS Compliant.

High Density

Micro MATE-N-LOK 3 mm Connector System  
.118 [3.00] Centerline



**Micro MATE-N-LOK 3 mm Connector System (Continued)**

**Right-Angle Header Assemblies (Continued)**

**Single Row, Surface Mount, with Surface Mount Hold-down**

**Material and Finish**

**Housing** — High Temperature Nylon, Black

**Flammability Rating** — UL 94V-0

**Contacts**—Brass

**Plating A**—.000100 [0.00254] min. tin over .000050 [0.00127] min. nickel

**Plating B**—.000015 [0.00038] gold in mating area, .000100 [0.00254] min. tin in solder area, with entire contact underplated .000050 [0.00127] min. nickel

**Plating C**—.000030 [0.00076] gold in mating area, .000100 [0.00254] min. tin in solder area, with entire contact underplated .000050 [0.00127] min. nickel

**Hold-downs**—Phosphor Bronze, .000100 [0.00254] min. tin over .000050 [0.00127] min. nickel

**Related Product Data**

**Mateable Housings:**

Single Row Receptacle Housing—page 23

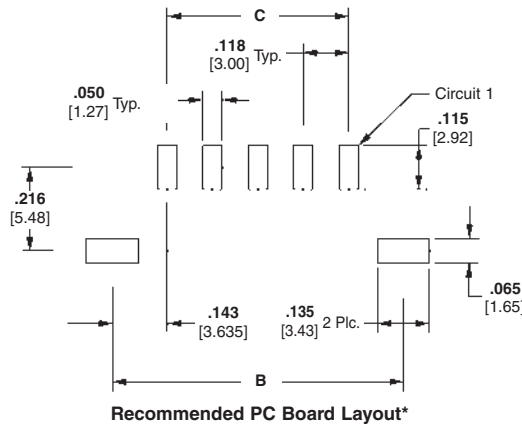
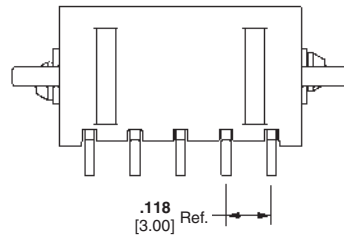
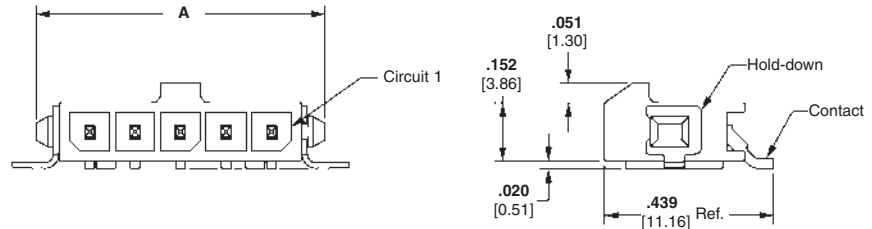

| Number of Circuits | Dimensions     |                |                | Header Part Numbers |             |             | Mates with Receptacle Housing Part Number |
|--------------------|----------------|----------------|----------------|---------------------|-------------|-------------|---|
|                    | A              | B              | C              | Plating A           | Plating B   | Plating C   |   |
| 2                  | .394<br>10.00  | .410<br>10.41  | .118<br>3.00   | 2-1445057-2         | 2-1445091-2 | 2-1445100-2 | 1445022-2                                 |
| 3                  | .512<br>13.00  | .528<br>13.41  | .236<br>6.00   | 2-1445057-3         | 2-1445091-3 | 2-1445100-3 | 1445022-3                                 |
| 4                  | .630<br>16.00  | .646<br>16.41  | .354<br>9.00   | 2-1445057-4         | 2-1445091-4 | 2-1445100-4 | 1445022-4                                 |
| 5                  | .748<br>19.00  | .764<br>19.41  | .472<br>12.00  | 2-1445057-5         | 2-1445091-5 | 2-1445100-5 | 1445022-5                                 |
| 6                  | .866<br>22.00  | .882<br>22.41  | .591<br>15.00  | 2-1445057-6         | 2-1445091-6 | 2-1445100-6 | 1445022-6                                 |
| 7                  | .984<br>25.00  | 1.000<br>25.41 | .709<br>18.00  | 2-1445057-7         | 2-1445091-7 | 2-1445100-7 | 1445022-7                                 |
| 8                  | 1.102<br>28.00 | 1.119<br>28.41 | .827<br>21.00  | 2-1445057-8         | 2-1445091-8 | 2-1445100-8 | 1445022-8                                 |
| 9                  | 1.220<br>31.00 | 1.237<br>31.41 | .945<br>24.00  | 2-1445057-9         | 2-1445091-9 | 2-1445100-9 | 1445022-9                                 |
| 10                 | 1.339<br>34.00 | 1.355<br>34.41 | 1.063<br>27.00 | 3-1445057-0         | 3-1445091-0 | 3-1445100-0 | 1-1445022-0                               |
| 11                 | 1.457<br>37.00 | 1.472<br>37.41 | 1.181<br>30.00 | 3-1445057-1         | 3-1445091-1 | 3-1445100-1 | 1-1445022-1                               |
| 12                 | 1.575<br>40.00 | 1.591<br>40.41 | 1.299<br>33.00 | 3-1445057-2         | 3-1445091-2 | 3-1445100-2 | 1-1445022-2                               |

\*Always consult customer drawing for PC Board layout dimensions.

**Note: All part numbers are RoHS Compliant.**

**Micro MATE-N-LOK 3 mm Connector System (Continued)**

**Right-Angle Header Assemblies (Continued)**

**Single Row, Surface Mount, with Plastic Boardlock**

**Material and Finish**

**Housing** — High Temperature Nylon, Black

**Flammability Rating** — UL 94V-0

**Contacts** — Brass

**Plating A** — .000100 [0.00254] min. tin over .000050 [0.00127] min. nickel

**Plating B** — .000015 [0.00038] gold in mating area, .000100 [0.00254] min. tin in solder area, with entire contact underplated .000050 [0.00127] min. nickel

**Plating C** — .000030 [0.00076] gold in mating area, .000100 [0.00254] min. tin in solder area, with entire contact underplated .000050 [0.00127] min. nickel

**Related Product Data**

**Mateable Housings:**

Single Row Receptacle Housing— page 23

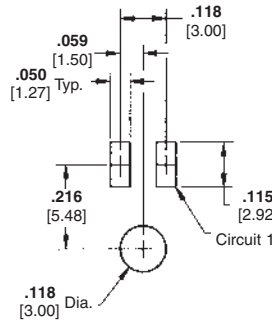

**Recommended PC Board Layout \* 2 Position**

**Recommended PC Board Layout \* 3 Position**

**Recommended PC Board Layout\* 4-12 Positions**

| Number of Circuits | Dimensions     |                |                | Header Part Numbers |             |             | Mates with Receptacle Housing Part Number |
|--------------------|----------------|----------------|----------------|---------------------|-------------|-------------|---|
|                    | A              | B              | C              | Plating A           | Plating B   | Plating C   |   |
| 2                  | .394<br>10.00  | —              | —              | 2-1445058-2         | 2-1445092-2 | 2-1445101-2 | 1445022-2                                 |
| 3                  | .512<br>13.00  | —              | —              | 2-1445058-3         | 2-1445092-3 | 2-1445101-3 | 1445022-3                                 |
| 4                  | .630<br>16.00  | .185<br>4.70   | .354<br>9.00   | 2-1445058-4         | 2-1445092-4 | 2-1445101-4 | 1445022-4                                 |
| 5                  | .748<br>19.00  | .303<br>7.70   | .472<br>12.00  | 2-1445058-5         | 2-1445092-5 | 2-1445101-5 | 1445022-5                                 |
| 6                  | .866<br>22.00  | .421<br>10.70  | .591<br>15.00  | 2-1445058-6         | 2-1445092-6 | 2-1445101-6 | 1445022-6                                 |
| 7                  | .984<br>25.00  | .539<br>13.70  | .709<br>18.00  | 2-1445058-7         | 2-1445092-7 | 2-1445101-7 | 1445022-7                                 |
| 8                  | 1.102<br>28.00 | .657<br>16.70  | .827<br>21.00  | 2-1445058-8         | 2-1445092-8 | 2-1445101-8 | 1445022-8                                 |
| 9                  | 1.220<br>31.00 | .776<br>19.70  | .945<br>24.00  | 2-1445058-9         | 2-1445092-9 | 2-1445101-9 | 1445022-9                                 |
| 10                 | 1.339<br>34.00 | .894<br>22.70  | 1.063<br>27.00 | 3-1445058-0         | 3-1445092-0 | 3-1445101-0 | 1-1445022-0                               |
| 11                 | 1.457<br>37.00 | 1.012<br>25.70 | 1.181<br>30.00 | 3-1445058-1         | 3-1445092-1 | 3-1445101-1 | 1-1445022-1                               |
| 12                 | 1.575<br>40.00 | 1.130<br>28.70 | 1.299<br>33.00 | 3-1445058-2         | 3-1445092-2 | 3-1445101-2 | 1-1445022-2                               |

\*Recommended PC Board thickness .062 [1.57]. Always consult customer drawing for PC Board layout dimensions.

**Note:** All part numbers are RoHS Compliant.

**Micro MATE-N-LOK 3 mm Connector System (Continued)**

High Density

Micro MATE-N-LOK 3 mm Connector System  
.118 [3.00] Centerline

**Right-Angle Header Assemblies (Continued)**

**Dual Row, Through-Hole, with Metal Through-Hole Hold-down**

**Material and Finish**

**Housing** — High Temperature Nylon, Black

**Flammability Rating** — UL 94V-0

**Contacts** — Brass

**Plating A** — .000100 [0.00254] min. tin over .000050 [0.00127] min. nickel

**Plating B** — .000015 [0.00038] gold in mating area, .000100 [0.00254] min. tin in solder area, with entire contact underplated .000050 [0.00127] min. nickel

**Plating C** — .000030 [0.00076] gold in mating area, .000100 [0.00254] min. tin in solder area, with entire contact underplated .000050 [0.00127] min. nickel

**Hold-downs** — Phosphor Bronze, .000100 [0.00254] min. tin over .000050 [0.00127] min. nickel

**Related Product Data**

**Mateable Housings:**

Dual Row Receptacle Housing—page 24

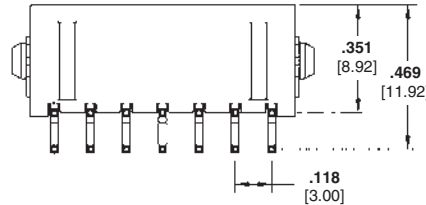
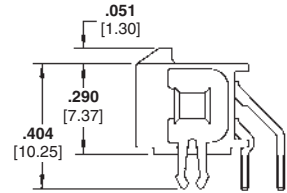
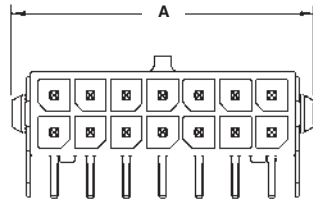

**Recommended PC Board Layout\***

| Number of Circuits | Dimensions     |                |                | Header Part Numbers |            |            | Mates with Receptacle Housing Part Number |
|--------------------|----------------|----------------|----------------|---------------------|------------|------------|---|
|                    | A              | B              | C              | Plating A           | Plating B  | Plating C  |   |
| 2                  | .276<br>7.00   | .169<br>4.30   | —              | 3-794677-2          | 3-794678-2 | 3-794679-2 | 794617-2                                  |
| 4                  | .394<br>10.00  | .287<br>7.30   | .118<br>3.00   | 3-794677-4          | 3-794678-4 | 3-794679-4 | 794617-4                                  |
| 6                  | .512<br>13.00  | .406<br>10.30  | .236<br>6.00   | 3-794677-6          | 3-794678-6 | 3-794679-6 | 794617-6                                  |
| 8                  | .630<br>16.00  | .524<br>13.30  | .354<br>9.00   | 3-794677-8          | 3-794678-8 | 3-794679-8 | 794617-8                                  |
| 10                 | .748<br>19.00  | .642<br>16.30  | .472<br>12.00  | 4-794677-0          | 4-794678-0 | 4-794679-0 | 1-794617-0                                |
| 12                 | .866<br>22.00  | .760<br>19.30  | .591<br>15.00  | 4-794677-2          | 4-794678-2 | 4-794679-2 | 1-794617-2                                |
| 14                 | .984<br>25.00  | .878<br>22.30  | .709<br>18.00  | 4-794677-4          | 4-794678-4 | 4-794679-4 | 1-794617-4                                |
| 16                 | 1.102<br>28.00 | .996<br>25.30  | .827<br>21.00  | 4-794677-6          | 4-794678-6 | 4-794679-6 | 1-794617-6                                |
| 18                 | 1.220<br>31.00 | 1.114<br>28.30 | .945<br>24.00  | 4-794677-8          | 4-794678-8 | 4-794679-8 | 1-794617-8                                |
| 20                 | 1.339<br>34.00 | 1.232<br>31.30 | 1.063<br>27.00 | 5-794677-0          | 5-794678-0 | 5-794679-0 | 2-794617-0                                |
| 22                 | 1.457<br>37.00 | 1.350<br>34.30 | 1.181<br>30.00 | 5-794677-2          | 5-794678-2 | 5-794679-2 | 2-794617-2                                |
| 24                 | 1.575<br>40.00 | 1.469<br>37.30 | 1.299<br>33.00 | 5-794677-4          | 5-794678-4 | 5-794679-4 | 2-794617-4                                |

\*Recommended PC Board thickness .062 [1.57]. Always consult customer drawing for PC Board layout dimensions.

**Note:** All part numbers are RoHS Compliant.

**Micro MATE-N-LOK 3 mm Connector System (Continued)**

**Right-Angle Header Assemblies (Continued)**

**Dual Row, Through-Hole, with Plastic Boardlock**



**Material and Finish**

**Housing** — High Temperature Nylon, Black

**Flammability Rating** — UL 94V-0

**Contacts**—Brass

**Plating A**—.000100 [0.00254] min. tin over .000050 [0.00127] min. nickel

**Plating B**—.000015 [0.00038] gold in mating area, .000100 [0.00254] min. tin in solder area, with entire contact underplated .000050 [0.00127] min. nickel

**Plating C**—.000030 [0.00076] gold in mating area, .000100 [0.00254] min. tin in solder area, with entire contact underplated .000050 [0.00127] min. nickel

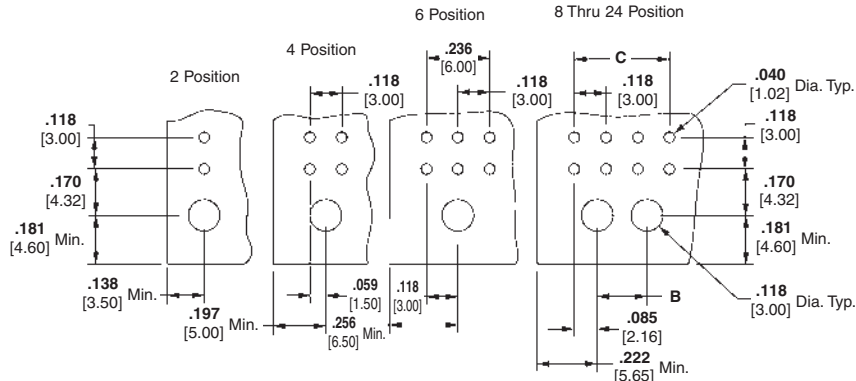
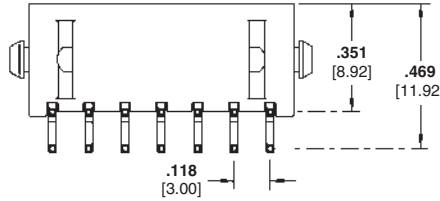

**Related Product Data**

**Mateable Housings:**

Dual Row Receptacle Housing—page 24

**Recommended PC Board Layout\***

| Number of Circuits | Dimensions     |                |                | Header Part Numbers |            |            | Mates with Receptacle Housing Part Number |
|--------------------|----------------|----------------|----------------|---------------------|------------|------------|---|
|                    | A              | B              | C              | Plating A           | Plating B  | Plating C  |   |
| 2                  | .276<br>7.00   | —              | —              | 3-794618-2          | 3-794619-2 | 3-794620-2 | 794617-2                                  |
| 4                  | .394<br>10.00  | —              | .118<br>3.00   | 3-794618-4          | 3-794619-4 | 3-794620-4 | 794617-4                                  |
| 6                  | .512<br>13.00  | —              | .236<br>6.00   | 3-794618-6          | 3-794619-6 | 3-794620-6 | 794617-6                                  |
| 8                  | .630<br>16.00  | .185<br>4.70   | .354<br>9.00   | 3-794618-8          | 3-794619-8 | 3-794620-8 | 794617-8                                  |
| 10                 | .748<br>19.00  | .303<br>7.70   | .472<br>12.00  | 4-794618-0          | 4-794619-0 | 4-794620-0 | 1-794617-0                                |
| 12                 | .866<br>22.00  | .421<br>10.70  | .591<br>15.00  | 4-794618-2          | 4-794619-2 | 4-794620-2 | 1-794617-2                                |
| 14                 | .984<br>25.00  | .539<br>13.70  | .709<br>18.00  | 4-794618-4          | 4-794619-4 | 4-794620-4 | 1-794617-4                                |
| 16                 | 1.102<br>28.00 | .657<br>16.70  | .827<br>21.00  | 4-794618-6          | 4-794619-6 | 4-794620-6 | 1-794617-6                                |
| 18                 | 1.220<br>31.00 | .776<br>19.70  | .945<br>24.00  | 4-794618-8          | 4-794619-8 | 4-794620-8 | 1-794617-8                                |
| 20                 | 1.339<br>34.00 | .894<br>22.70  | 1.063<br>27.00 | 5-794618-0          | 5-794619-0 | 5-794620-0 | 2-794617-0                                |
| 22                 | 1.457<br>37.00 | 1.012<br>25.70 | 1.181<br>30.00 | 5-794618-2          | 5-794619-2 | 5-794620-2 | 2-794617-2                                |
| 24                 | 1.575<br>40.00 | 1.130<br>28.70 | 1.299<br>33.00 | 5-794618-4          | 5-794619-4 | 5-794620-4 | 2-794617-4                                |

\*Recommended PC Board thickness .062 [1.57]. Always consult customer drawing for PC Board layout dimensions.

**Note: All part numbers are RoHS Compliant.**

**Micro MATE-N-LOK 3 mm Connector System (Continued)**

High Density

Micro MATE-N-LOK 3 mm Connector System  
.118 [3.00] Centerline

**Right-Angle Header Assemblies (Continued)**

**Dual Row, Surface Mount, with Metal Through-Hole Hold-down**



**Material and Finish**

**Housing** — High Temperature Nylon, Black

**Flammability Rating** — UL 94V-0

**Contacts**—Brass

**Plating A**—.000100 [0.00254] min. tin over .000050 [0.00127] min. nickel

**Plating B**—.000015 [0.00038] gold in mating area, .000100 [0.00254] min. tin in solder area, with entire contact underplated .000050 [0.00127] min. nickel

**Plating C**—.000030 [0.00076] gold in mating area, .000100 [0.00254] min. tin in solder area, with entire contact underplated .000050 [0.00127] min. nickel

**Hold-downs**—Phosphor Bronze, .000100 [0.00254] min. tin over .000050 [0.00127] min. nickel



**Recommended PC Board Layout\***

**Related Product Data**

**Mateable Housings:**

Dual Row Receptacle Housing—page 24

| Number of Circuits | Dimensions     |                |                | Header Part Numbers |            |            | Mates with Receptacle Housing Part Number |
|--------------------|----------------|----------------|----------------|---------------------|------------|------------|---|
|                    | A              | B              | C              | Plating A           | Plating B  | Plating C  |   |
| 2                  | .276<br>7.00   | .169<br>4.30   | —              | 3-794624-2          | 3-794625-2 | 3-794626-2 | 794617-2                                  |
| 4                  | .394<br>10.00  | .287<br>7.30   | .118<br>3.00   | 3-794624-4          | 3-794625-4 | 3-794626-4 | 794617-4                                  |
| 6                  | .512<br>13.00  | .406<br>10.30  | .236<br>6.00   | 3-794624-6          | 3-794625-6 | 3-794626-6 | 794617-6                                  |
| 8                  | .630<br>16.00  | .524<br>13.30  | .354<br>9.00   | 3-794624-8          | 3-794625-8 | 3-794626-8 | 794617-8                                  |
| 10                 | .748<br>19.00  | .642<br>16.30  | .472<br>12.00  | 4-794624-0          | 4-794625-0 | 4-794626-0 | 1-794617-0                                |
| 12                 | .866<br>22.00  | .760<br>19.30  | .591<br>15.00  | 4-794624-2          | 4-794625-2 | 4-794626-2 | 1-794617-2                                |
| 14                 | .984<br>25.00  | .878<br>22.30  | .709<br>18.00  | 4-794624-4          | 4-794625-4 | 4-794626-4 | 1-794617-4                                |
| 16                 | 1.102<br>28.00 | .996<br>25.30  | .827<br>21.00  | 4-794624-6          | 4-794625-6 | 4-794626-6 | 1-794617-6                                |
| 18                 | 1.220<br>31.00 | 1.114<br>28.30 | .945<br>24.00  | 4-794624-8          | 4-794625-8 | 4-794626-8 | 1-794617-8                                |
| 20                 | 1.339<br>34.00 | 1.232<br>31.30 | 1.063<br>27.00 | 5-794624-0          | 5-794625-0 | 5-794626-0 | 2-794617-0                                |
| 22                 | 1.457<br>37.00 | 1.350<br>34.30 | 1.181<br>30.00 | 5-794624-2          | 5-794625-2 | 5-794626-2 | 2-794617-2                                |
| 24                 | 1.575<br>40.00 | 1.469<br>37.30 | 1.299<br>33.00 | 5-794624-4          | 5-794625-4 | 5-794626-4 | 2-794617-4                                |

\*Recommended PC Board thickness .062 [1.57]. Always consult customer drawing for PC Board layout dimensions.

**Note:** All part numbers are RoHS Compliant.

**Micro MATE-N-LOK 3 mm Connector System (Continued)**

**Right-Angle Header Assemblies (Continued)**  
**Dual Row, Surface Mount, with Plastic Boardlock**

**Material and Finish**

**Housing** — High Temperature Nylon, Black

**Flammability Rating** — UL 94V-0

**Contacts** — Brass

**Plating A** — .000100 [0.00254] min. tin over .000050 [0.00127] min. nickel

**Plating B** — .000015 [0.00038] gold in mating area, .000100 [0.00254] min. tin in solder area, with entire contact underplated .000050 [0.00127] min. nickel

**Plating C** — .000030 [0.00076] gold in mating area, .000100 [0.00254] min. tin in solder area, with entire contact underplated .000050 [0.00127] min. nickel

**Related Product Data**

**Mateable Housings:**

Dual Row Receptacle Housing—page 24



| Number of Circuits | Dimensions     |                |                | Header Part Numbers |            |            | Mates with Receptacle Housing Part Number |
|--------------------|----------------|----------------|----------------|---------------------|------------|------------|---|
|                    | A              | B              | C              | Plating A           | Plating B  | Plating C  |   |
| 2                  | .276<br>7.00   | —              | —              | 3-794621-2          | 3-794622-2 | 3-794623-2 | 794617-2                                  |
| 4                  | .394<br>10.00  | —              | .118<br>3.00   | 3-794621-4          | 3-794622-4 | 3-794623-4 | 794617-4                                  |
| 6                  | .512<br>13.00  | —              | .236<br>6.00   | 3-794621-6          | 3-794622-6 | 3-794623-6 | 794617-6                                  |
| 8                  | .630<br>16.00  | .185<br>4.70   | .354<br>9.00   | 3-794621-8          | 3-794622-8 | 3-794623-8 | 794617-8                                  |
| 10                 | .748<br>19.00  | .303<br>7.70   | .472<br>12.00  | 4-794621-0          | 4-794622-0 | 4-794623-0 | 1-794617-0                                |
| 12                 | .866<br>22.00  | .421<br>10.70  | .591<br>15.00  | 4-794621-2          | 4-794622-2 | 4-794623-2 | 1-794617-2                                |
| 14                 | .984<br>25.00  | .539<br>13.70  | .709<br>18.00  | 4-794621-4          | 4-794622-4 | 4-794623-4 | 1-794617-4                                |
| 16                 | 1.102<br>28.00 | .657<br>16.70  | .827<br>21.00  | 4-794621-6          | 4-794622-6 | 4-794623-6 | 1-794617-6                                |
| 18                 | 1.220<br>31.00 | .776<br>19.70  | .945<br>24.00  | 4-794621-8          | 4-794622-8 | 4-794623-8 | 1-794617-8                                |
| 20                 | 1.339<br>34.00 | .894<br>22.70  | 1.063<br>27.00 | 5-794621-0          | 5-794622-0 | 5-794623-0 | 2-794617-0                                |
| 22                 | 1.457<br>37.00 | 1.012<br>25.70 | 1.181<br>30.00 | 5-794621-2          | 5-794622-2 | 5-794623-2 | 2-794617-2                                |
| 24                 | 1.575<br>40.00 | 1.130<br>28.70 | 1.299<br>33.00 | 5-794621-4          | 5-794622-4 | 5-794623-4 | 2-794617-4                                |

\*Recommended PC Board thickness .062 [1.57]. Always consult customer drawing for PC Board layout dimensions.

**Note: All part numbers are RoHS Compliant.**

**Micro MATE-N-LOK 3 mm Connector System (Continued)**

**Right-Angle Header Assemblies (Continued)**

**Dual Row, Surface Mount, with Surface Mount Hold-down**

**Material and Finish**

**Housing** — High Temperature Nylon, Black

**Flammability Rating** — UL 94V-0

**Contacts**—Brass

**Plating A**— .000100 [0.00254] min. tin over .000050 [0.00127] min. nickel

**Plating B**— .000015 [0.00038] gold in mating area, .000100 [0.00254] min. tin in solder area, with entire contact underplated .000050 [0.00127] min. nickel

**Plating C**— .000030 [0.00076] gold in mating area, .000100 [0.00254] min. tin in solder area, with entire contact underplated .000050 [0.00127] min. nickel

**Hold-downs**—Phosphor Bronze, .000100 [0.00254] min. tin over .000050 [0.00127] min. nickel

**Related Product Data**

**Mateable Housings:**

Dual Row Receptacle Housing—page 24

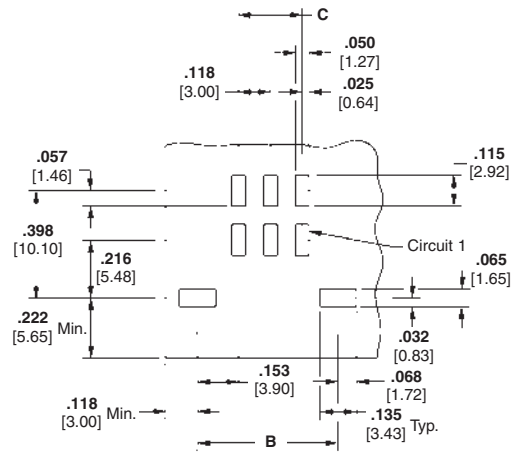
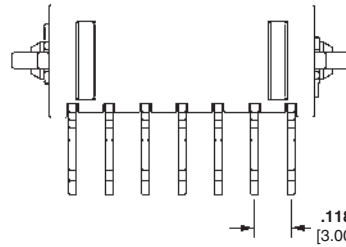
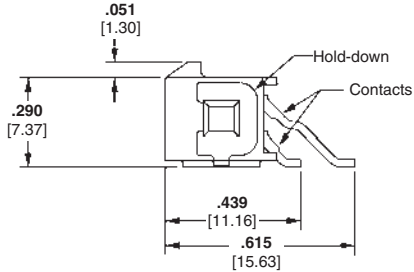
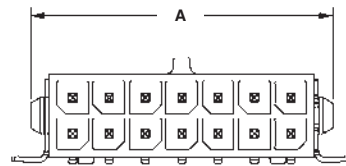

**Recommended PC Board Layout\***

| Number of Circuits | Dimensions     |                |                | Header Part Numbers |            |            | Mates with Receptacle Housing Part Number |
|--------------------|----------------|----------------|----------------|---------------------|------------|------------|---|
|                    | A              | B              | C              | Plating A           | Plating B  | Plating C  |   |
| 2                  | .276<br>7.00   | .276<br>7.27   | —              | 3-794627-2          | 3-794628-2 | 3-794629-2 | 794617-2                                  |
| 4                  | .394<br>10.00  | .394<br>10.27  | .118<br>3.00   | 3-794627-4          | 3-794628-4 | 3-794629-4 | 794617-4                                  |
| 6                  | .512<br>13.00  | .512<br>13.27  | .236<br>6.00   | 3-794627-6          | 3-794628-6 | 3-794629-6 | 794617-6                                  |
| 8                  | .630<br>16.00  | .630<br>16.27  | .354<br>9.00   | 3-794627-8          | 3-794628-8 | 3-794629-8 | 794617-8                                  |
| 10                 | .748<br>19.00  | .748<br>19.27  | .472<br>12.00  | 4-794627-0          | 4-794628-0 | 4-794629-0 | 1-794617-0                                |
| 12                 | .866<br>22.00  | .866<br>22.27  | .591<br>15.00  | 4-794627-2          | 4-794628-2 | 4-794629-2 | 1-794617-2                                |
| 14                 | .984<br>25.00  | .984<br>25.27  | .709<br>18.00  | 4-794627-4          | 4-794628-4 | 4-794629-4 | 1-794617-4                                |
| 16                 | 1.102<br>28.00 | 1.102<br>28.27 | .827<br>21.00  | 4-794627-6          | 4-794628-6 | 4-794629-6 | 1-794617-6                                |
| 18                 | 1.220<br>31.00 | 1.220<br>31.27 | .945<br>24.00  | 4-794627-8          | 4-794628-8 | 4-794629-8 | 1-794617-8                                |
| 20                 | 1.339<br>34.00 | 1.339<br>34.27 | 1.063<br>27.00 | 5-794627-0          | 5-794628-0 | 5-794629-0 | 2-794617-0                                |
| 22                 | 1.457<br>37.00 | 1.457<br>37.27 | 1.181<br>30.00 | 5-794627-2          | 5-794628-2 | 5-794629-2 | 2-794617-2                                |
| 24                 | 1.575<br>40.00 | 1.575<br>40.27 | 1.299<br>33.00 | 5-794627-4          | 5-794628-4 | 5-794629-4 | 2-794617-4                                |

\*Always consult customer drawing for PC Board layout dimensions.

**Note:** All part numbers are RoHS Compliant.

---

**Engineering Notes**

---





**Grace Inertia Connectors (GIC), 3.5 mm Centerline  
(Wire-to-Wire Connectors)**

**Product Facts**

- Small wire-to-wire connectors (3.5 mm centerline) can handle 18 AWG wire
- Locking mechanism helps prevent connectors from being disconnected during movement or transportation
- Four kinds of keying per color-coded housing
- Improved housing shape offers easier mating
- Complies with lead free requirements
- Recognized under the Component Program of Underwriters Laboratories Inc., File No. E28476
- Certified by Canadian Standards Association, File No. E28476



**Performance Characteristics**

- Voltage Rating**—300 VAC
- Current Rating**—7 A (max.)
- Centerline**—3.5 mm
- Applicable Wire**—26 to 18 AWG
- Temperature Rating**—  
-30°C to 105°C

This connector employs the inertia locking mechanism, which simultaneously locks when mated to help prevent mismatching. It is widely used for large-sized household electric appliances, such as refrigerators, washing machines, or dispensers. Depending on the working environment, a locking sound is difficult to confirm during mating of a connector. However, this connector supports secure mating operation even in such a working environment.

**Material and Finish**

- Housing**—6/6 Nylon UL94V-0 (CTI 600 V or more)
- Terminal**—Pre-tin Copper alloy

**Technical Documents**

- Product Specification**  
108-5810
- Application Specification**  
114-5306

**Note:** All dimensions shown are metric.

**Grace Inertia Connectors (GIC), 3.5 mm Centerline  
(Wire-to-Wire Connectors)** (Continued)

**Contacts**

**Material and Finish**

Pre-tinned Copper Alloy

**Receptacle Contact (For Plug Housing)**

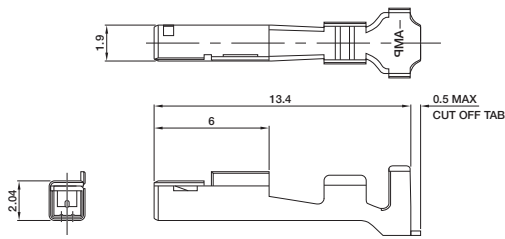

**Tab Contact (For Cap Housing)**

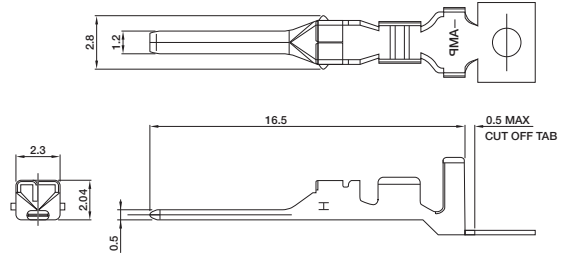

| Wire Range |                 | Insulation Dia.<br>mm | Contact Part Number |           | Tool Part Number      |                       |
|------------|-----------------|-----------------------|---------------------|-----------|-----------------------|-----------------------|
| AWG        | mm <sup>2</sup> |                       | Receptacle          | Tab       | Terminator/Applicator | CERTI-CRIMP Hand Tool |
| 26-22      | 0.13-0.34       | 1.3-2.0               | 1612334-1           | 1612335-1 | **                    | —                     |
| 22-18      | 0.3-0.9         | 1.5-2.7               | 1565079-1           | 1565080-1 | **                    | 1596277-1             |

\*Cut the contact carrier strip when using a hand tool.

\*\* Contact the Tooling Assistance Center (TAC) at 1-800-722-1111 for Terminator or Applicator Part Numbers.

**Double Lock Plates**

**Material**

6/6 Nylon glass filled (UL94V-0)

**2 Position**

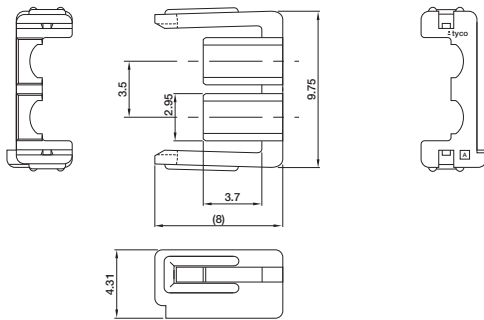

P/N 1565089-1  
\*Two four-positions are used.

**3 Position**

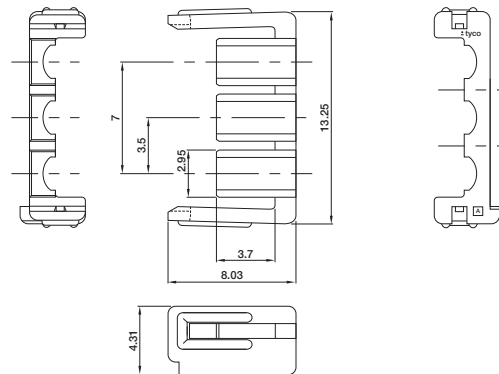

P/N 1565090-1  
\*Two six-positions are used.

**Note:** All dimensions shown are metric.

**Note:** All part numbers are RoHS Compliant.

**Grace Inertia Connectors (GIC), 3.5 mm Centerline  
(Wire-to-Wire Connectors)** (Continued)

**2 Position**

**Material**

6/6 Nylon, UL94V-0 (CTI 600 V or more)

**Plug Housing (For Receptacles)**



**Cap Housing (For Tabs)**



**Related Product Data**

Receptacle and Tab Contacts—page 50

Double Lock Plate—page 50

| Color   | Keying | Part Number  |             |
|---------|--------|--------------|-------------|
|         |        | Plug Housing | Cap Housing |
| Natural | A      | 1565081-1    | 1565085-1   |
| Red     | B      | 1-1565081-2  | 1-1565085-2 |
| Blue    | C      | 2-1565081-3  | 2-1565085-3 |
| Yellow  | D      | 3-1565081-4  | 3-1565085-4 |

**3 Position**

**Material**

6/6 Nylon, UL94V-0 (CTI 600 V or more)

**Plug Housing (For Receptacles)**



**Cap Housing (For Tabs)**



| Color   | Keying | Part Number  |             |
|---------|--------|--------------|-------------|
|         |        | Plug Housing | Cap Housing |
| Natural | A      | 1565082-1    | 1565086-1   |
| Red     | B      | 1-1565082-2  | 1-1565086-2 |
| Blue    | C      | 2-1565082-3  | 2-1565086-3 |
| Yellow  | D      | 3-1565082-4  | 3-1565086-4 |

**Note:** All dimensions shown are metric.

**Note:** All part numbers are RoHS Compliant.

**Grace Inertia Connectors (GIC), 3.5 mm Centerline  
(Wire-to-Wire Connectors)** (Continued)

**4 Position**

**Plug Housing (For Receptacles)**

**Cap Housing (For Tabs)**

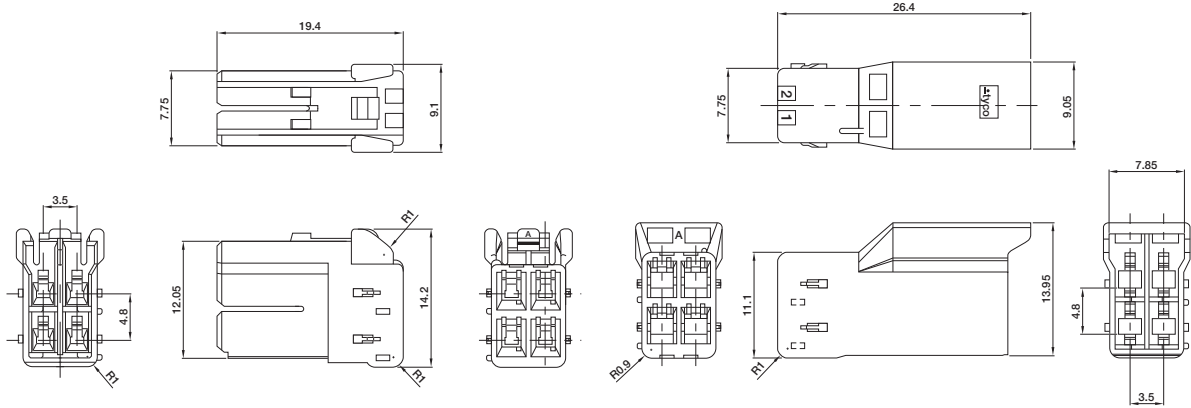

**Material**

6/6 Nylon, UL94V-0 (CTI 600 V or more)

**Related Product Data**

Receptacle and Tab Contacts—page 50

Double Lock Plate—page 50

| Color   | Keying | Part Number  |             |
|---------|--------|--------------|-------------|
|         |        | Plug Housing | Cap Housing |
| Natural | A      | 1565083-1    | 1565087-1   |
| Red     | B      | 1-1565083-2  | 1-1565087-2 |
| Blue    | C      | 2-1565083-3  | 2-1565087-3 |
| Yellow  | D      | 3-1565083-4  | 3-1565087-4 |

**6 Position**

**Plug Housing (For Receptacles)**

**Cap Housing (For Tabs)**

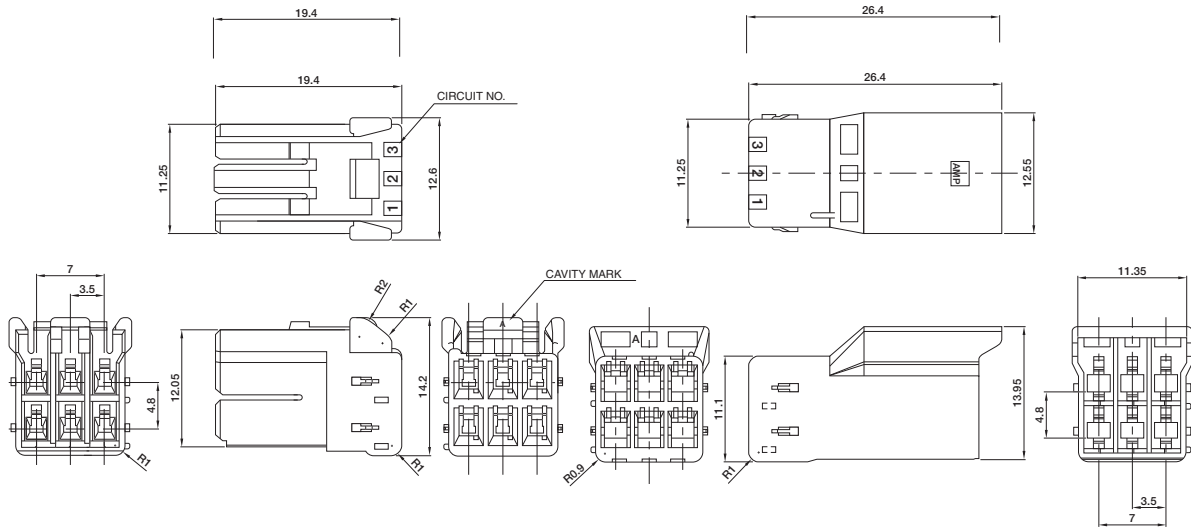

**Material**

6/6 Nylon, UL94V-0 (CTI 600 V or more)

| Color   | Keying | Part Number  |             |
|---------|--------|--------------|-------------|
|         |        | Plug Housing | Cap Housing |
| Natural | A      | 1565084-1    | 1565088-1   |
| Red     | B      | 1-1565084-2  | 1-1565088-2 |
| Blue    | C      | 2-1565084-3  | 2-1565088-3 |
| Yellow  | D      | 3-1565084-4  | 3-1565088-4 |

**Note:** All dimensions shown are metric.

**Note:** All part numbers are RoHS Compliant.

**.062 [1.57] Commercial Pin and Socket Connectors**

**Product Facts**

- Polarized
- Cavity identification
- Low contact-mating force
- Dual locking lances
- Detent and positive locking
- Contacts available in brass and phosphor bronze with tin and gold plating
- Panel mount and free-hanging styles
- "F" crimp contacts
- Applicator and hand tool available
- Economical commercial-grade connectors
- Compatible with high-speed application machinery and most other manufacturers' soft shells
- Wire range 30 to 18 AWG [0.05 to 0.9 mm<sup>2</sup>]
- Accepts wires with insulation diameters as large as .110 [2.79]
- Housings available in 1 to 9 positions
- .062 plug and receptacle housings accept pin or socket contacts. The preferred convention is to use socket contacts with receptacle housings
- Not for interrupting current
- Recognized under the Component Program of Underwriters Laboratories Inc., File No. E28476
- Certified by Canadian Standards Association, File No. LR 7189



**Performance Characteristics**

The .062 Commercial Pin and Socket Connectors performance characteristics found on pages 53-54 are based on free-hanging and panel mount connectors, loaded with contacts crimped on stranded wire.

- Durability**—10 mating cycles
- Dielectric Withstanding Voltage**—1.0 kVAC
- Insulation Resistance**—1000 megohms min. initial
- Voltage Rating**—250 V AC or DC
- Connector Mating**—2.5 lb. [11.1 N] max. per contact
- Connector Unmating**—0.3 lb. [1.3 N] min. per contact
- Contact Insertion Force**—4.0 lb. [17.8 N] max. per contact
- Contact Retention**—7 lb. [31.1 N] min.  
15 lb. [66.6 N] min. for contacts 770983-1 and 794380-1

**Technical Documents**

- Product Specification**  
108-1037 .062 Commercial Pin and Socket Connectors
- Application Specification**  
114-1013 .062 Commercial Pin and Socket Connectors

High Density

.062 [1.57] Commercial Pin and Socket Connectors  
.145 [3.68] Centerline

**.062 [1.57] Commercial Pin and Socket Connectors** (Continued)

**Performance Characteristics**  
(Continued)

**Maximum Current**—Maximum current rating of .062 Commercial Pin and Socket connectors is limited by the maximum operating temperature of the housings which is 105°C including the temperature rise of the contacts which is a maximum of 30°C. There are several variables which have a direct effect on this maximum current-carrying capability for a given connector and must be considered for each application. These variables are:

**Wire Size**—Larger wire will carry more current since it has less internal resistance to current flow and thus generates less heat. Longer wire lengths also enhance current-carrying capabilities since the wire conducts heat away from the connector.

**Connector Size**—In general, the more circuits in a connector, the less current can be carried.

**Ambient Temperature**—The higher the ambient temperature, the less current can be carried in any given connector.

**Related Product Data**

**Product Specification** —  
108-1037

**Application Specification** —  
114-1013

**Current Rating Verification for 30°C Maximum Temperature Rise 100% Energized**

**Wire-to-Wire**

**.062 Commercial Pin and Socket Connectors Calculated Current Table**

| Number of Circuits | Wire Gauge |      |      |      |
|--------------------|------------|------|------|------|
|                    | 18         | 20   | 22   | 24   |
| 2                  | 7.00       | 6.00 | 5.00 | 4.00 |
| 3                  | 7.00       | 6.00 | 5.00 | 4.00 |
| 4                  | 6.00       | 6.00 | 5.00 | 4.00 |
| 4                  | 6.00       | 5.00 | 4.00 | 3.00 |
| 6                  | 6.00       | 5.00 | 4.00 | 3.00 |
| 9                  | 5.00       | 4.00 | 4.00 | 3.00 |

Values are based on initial Temperature Rise versus Current Testing and are intended to be a guide in the selection of a connector family. All applications should be tested by the end user. The values listed are per circuit for fully loaded housings being 100% energized. **Note:** All combinations were not tested, and this chart contains interpolated and extrapolated values.

**Minimum Wire Lengths for T-Rise vs. Current Testing**

| AWG | Min. Length (in.) | AWG | Min. Length (in.) |
|-----|-------------------|-----|-------------------|
| 30  | 2.6               | 18  | 9.4               |
| 28  | 3.2               | 16  | 11.3              |
| 26  | 4.1               | 14  | 13.7              |
| 24  | 5.1               | 12  | 16.4              |
| 20  | 7.8               | 10  | 19.3              |

**Note:** If wire lengths used are less than those listed above, the current-carrying ability of the system will be reduced due to less heat being conducted away from the connector. The customer should fully test all applications.

**Termination Resistance/Contact Crimp Tensile Force**

| Wire Size |                 | Termination Resistance |                                   | Contact Crimp Tensile Force |      |
|-----------|-----------------|------------------------|-----------------------------------|-----------------------------|------|
| AWG       | mm <sup>2</sup> | Test Current (Amps)    | Resistance Milliohms (Max. Init.) | Force (Min.)                |      |
|           |                 |                        |                                   | lbs.                        | N    |
| 24        | 0.2             | 1.5                    | 3.50                              | 10                          | 44.5 |
| 22        | 0.3–0.4         | 3.0                    | 3.50                              | 10                          | 44.5 |
| 20        | 0.5–0.6         | 4.5                    | 3.00                              | 13                          | 57.8 |
| 18        | 0.8–0.9         | 6.0                    | 3.00                              | 14                          | 62.3 |

**Note:** This is the total resistance between wire crimps of a mated pin and socket.

High Density

.062 [1.57] Commercial Pin and Socket Connectors  
.145 [3.68] Centerline

**.062 [1.57] Commercial Pin and Socket Connectors** (Continued)

**Contacts**

Pin Diameter .062 [1.57]

**Material**

.008 [0.20] Stock Thickness  
Pin and socket contacts can be used in either plug or receptacle housings. It is preferred to use socket contacts in receptacle housings.

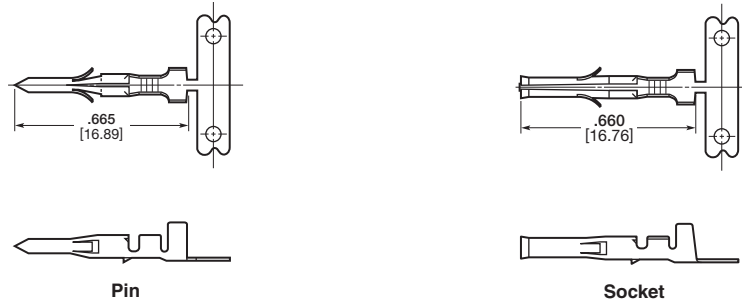

**Related Product Data**

**Performance Characteristics**—pages 53-54

**Housings**—pages 56-57

**Panel Cutouts**—page 57

**Technical Documents**—pages 53 and 205-206

**Application Tooling**—pages 207-210

**Product Specification**—108-1037-1

| Wire Size |                 | Ins. Dia.              | Material & Finish                    | Contact Part Numbers  |              |                       |              | HDM Applicator Part No.   | Hand Tool Part No. |
|-----------|-----------------|------------------------|--------------------------------------|-----------------------|--------------|-----------------------|--------------|---|--------------------|
| AWG       | mm <sup>2</sup> |                        |                                      | Pin                   |              | Socket                |              |   |                    |
|           |                 |                        |                                      | Strip Form            | Loose Pieces | Strip Form            | Loose Pieces |   |                    |
| 30-24     | 0.05-0.2        | .060<br>1.52 Max.      | Brass Pre-tin                        | 640391-1              | 794018-1     | 640392-1              | 794019-1     | 466686-1 <sup>3</sup><br>466686-2 <sup>3</sup><br>466686-3 <sup>3</sup> | 90870-1            |
|           |                 |                        | Brass, Select Gold <sup>1</sup>      | 640391-5 <sup>1</sup> | —            | 640392-5 <sup>1</sup> | —            |   |                    |
|           |                 |                        | Phos. Brz., Pre-tin                  | —                     | —            | 640392-2              | —            |   |                    |
| 24-18     | 0.2-0.9         | .050-.110<br>1.27-2.79 | Brass Pre-tin                        | 350629-1              | 794017-1     | 350628-1              | 794016-1     | 687996-1 <sup>3</sup><br>687996-2 <sup>3</sup><br>687996-3 <sup>3</sup> | 90869-1            |
|           |                 |                        | Phos. Brz., Pre-tin                  | 350629-8              | —            | 350628-2              | —            |   |                    |
|           |                 |                        | Brass, Select Gold <sup>1</sup>      | 350629-5 <sup>1</sup> | —            | 350628-5 <sup>1</sup> | —            |   |                    |
|           |                 |                        | Phos. Brz., Select Gold <sup>1</sup> | —                     | —            | 350628-6 <sup>1</sup> | —            |   |                    |

<sup>1</sup>Select Gold—.000030 [.000762] min. in mating area over .000050 [.00127] nickel.  
<sup>2</sup>Lanceless Socket for Overmolding.  
<sup>3</sup>HDM Applicator part number ending in -1 is used on AMPOMATOR CLS Machine with T or G Terminators, -2 is used on AMP-O-LECTRIC Model K Machine, -3 is used on AMP-O-LECTRIC Model G Machine. See pages 207-210 for further information.  
<sup>4</sup>Contact Retention 15 lbs. [66.6 N] min.

**Note:** Phosphor bronze contacts should be used in high-temperature/humidity cycling applications.  
**Note:** All part numbers are RoHS Compliant.



**Contact Insertion Tool**  
(for Pins and Sockets)  
Part No. 91002-1  
IS 408-7347



**Contact Extraction Tool**  
Part No. 318831-1  
IS 408-4370

**.062 [1.57] Commercial Pin and Socket Connectors** (Continued)

**Housings**

**Free-Hanging or Panel Mount**

.145 [3.68] Centerline spacing

**Material**

**Housing**—Nylon, natural color

**Flammability Rating**—UL94V-2

**Related Product Data**

**Contacts**—page 55

**Product Specification**—  
108-1037

**1 Circuit**



**2, 3, and 4 Circuit, In-Line**



| No. of Circuits | Dimensions    |               |               |               |               |               | Receptacle Part Numbers |                                   | Plug Part Numbers |              |
|-----------------|---------------|---------------|---------------|---------------|---------------|---------------|-------------------------|-----------------------------------|-------------------|--------------|
|                 | Receptacle    |               |               | Plug          |               |               | Panel Mount             | Free-Hanging                      | Panel Mount       | Free-Hanging |
|                 | A             | B             | C             | A             | B             | C             |                         |                                   |                   |              |
| 1               | —             | —             | .785<br>19.94 | —             | —             | .750<br>19.05 | —                       | 770277-1                          | —                 | 770278-1     |
| 2               | .340<br>8.64  | .199<br>5.05  | .820<br>20.83 | .440<br>11.18 | .300<br>7.62  | .780<br>19.81 | 770343-1                | 770342-1<br>770419-1 <sup>1</sup> | 770341-1          | 770340-1     |
| 3               | .490<br>12.45 | .199<br>5.05  | .785<br>19.94 | .590<br>14.99 | .300<br>7.62  | .750<br>19.05 | 770326-1                | 770333-1                          | 770332-1          | 770331-1     |
| 4<br>(In-Line)  | .635<br>16.13 | .199<br>5.05  | .785<br>19.94 | .733<br>18.62 | .300<br>7.62  | .750<br>19.05 | 770335-1                | 770274-1                          | 770334-1          | 770275-1     |
| 4<br>(Matrix)   | .345<br>8.76  | .345<br>8.76  | .878<br>22.30 | .445<br>11.30 | .445<br>11.30 | .868<br>22.04 | 770441-1                | 770442-1                          | 770443-1          | 770433-1     |
| 6               | .345<br>8.76  | .495<br>12.57 | .785<br>19.94 | .445<br>11.30 | .600<br>15.24 | .750<br>19.05 | 770354-1                | 770356-1                          | 770353-1          | 770355-1     |
| 9               | .490<br>12.45 | .495<br>12.57 | .790<br>20.07 | .590<br>14.99 | .600<br>15.24 | .750<br>19.05 | 770427-1                | 770429-1                          | 770426-1          | 770428-1     |

<sup>1</sup>Positive Lock

**Note:** All part numbers are RoHS Compliant.

High Density  
Commercial Pin and Socket Connectors  
.145 [3.68] Centerline



**.062 [1.57] Commercial Pin and Socket Connectors (Continued)**

**Housings**

**Free-Hanging or Panel Mount**

.145 [3.68] Centerline spacing

**Material**

**Housing** — Nylon, natural color

**Flammability Rating** — UL94V-2

**Related Product Data**

**Contacts** — page 55

**4, 6, and 9 Circuit, Matrix**



**Receptacle**



**Plug**

**Recommended Panel Cutouts**

Maximum panel thickness is .060 [1.52].

**Related Product Data**

**Product Specification** — 108-1037

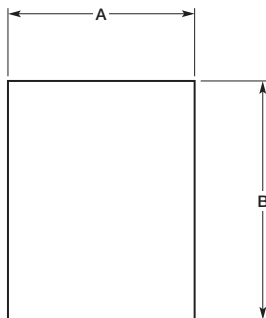

| No. of Circuits | Panel Cutout Dimensions |       |       |       |
|-----------------|-------------------------|-------|-------|-------|
|                 | Receptacle              |       | Plug  |       |
|                 | A                       | B     | A     | B     |
| 2               | .265                    | .505  | .318  | .609  |
|                 | 6.73                    | 12.83 | 8.08  | 15.47 |
| 3               | .265                    | .650  | .318  | .754  |
|                 | 6.73                    | 16.51 | 8.08  | 19.15 |
| 4 (In-Line)     | .260                    | .785  | .312  | .865  |
|                 | 6.60                    | 19.94 | 7.92  | 21.97 |
| 4 (Matrix)      | .400                    | .506  | .465  | .615  |
|                 | 10.16                   | 12.85 | 11.81 | 15.62 |
| 6               | .505                    | .552  | .607  | .615  |
|                 | 12.83                   | 14.02 | 15.42 | 15.62 |
| 9               | .552                    | .650  | .615  | .752  |
|                 | 14.02                   | 16.51 | 15.62 | 19.10 |

**Note:** The panel should be punched so that the housing enters in the same direction as the punch.

**Note:** All part numbers are RoHS Compliant.

---

**Engineering Notes**

---



**Power Double Lock (PDL) Connectors (Wire-to-Board and Wire-to-Wire)**

**Product Facts**

- Power circuit connectors of compact design
- Uses double lock plate on the wire side that helps prevent partial mating of contacts
- Double lock plate compatible with high-count positions of more than 3 rows
- Tab and receptacle contacts resist scooping of contacts at mating / unmating
- Locking of plug to cap housings and plug to board-mounted headers made by the semi-inner locking system that helps preclude the possibility of disengagement by external pressure
- Both wire-to-wire and wire-to-board applications available from the same Series lineup
- Board-mounted header compatible with resin coating, causing no hindrance with the plug locking function
- Design complies with a range of safety standards
- The housing lance design provides no lance on contacts and helps prevent entanglement of contacts with one another
- Fully polarized
- The following contact centerline by row centerline arrangements available:
  - For wire-to-wire application:  
3.96 mm x 4.6 mm  
6.5 mm x 6.5 mm
  - For wire-to-board application:  
3.96 mm x 4.6 mm  
7.92 mm x 4.6 mm  
6.5 mm x 6.5 mm
- Recognized under the Component Program of Underwriters Laboratories Inc., File No. E28476
- Certified by Canadian Standards Association, File No. LR7189
- VDE Approved, File No. B 04 11 39175010



Power Double Lock Connectors are compact connectors designed for use in power circuit applications and are ideally suited for wiring in refrigerators, air conditioners, washing machines, gas equipment, copying machines and automatic vending machines. These connectors can be used alone by inserting wire-terminated crimp snap-in contacts into the housing. However, to achieve more positive contact mounting, plug and cap housings can be equipped with a double lock plate that helps to completely insert contacts. There are three contact centerline spacings available: 3.96 mm, 6.5 mm and 7.92 mm. Of these, the 7.92 mm centerline contact arrangement is for 2-position board-mounted headers. The mating wire-mounted plug connector uses the second circuit of the 3-position 3.96 mm centerline housing with no contact loaded. Available with the 3.96 mm centerline contact arrangement are wire-mounted plug housings and the mating wire-mounted cap housings (for free-hanging and panel mounted

applications) and board-mounted tab headers. The 6.5 mm centerline contact arrangement is used in wire-mounted plug housings and the mating board-mounted tab headers. The plug housings are loaded with receptacle contacts and the cap housings with tab contacts. The tab headers for board mounting are preloaded with solder-dipping tab contacts with tail. Contacts accept two wire size ranges: 28-22 AWG (with insulation outer diameter of 1.3 to 2.0 mm) and 20-18 AWG (with insulation outer diameter of 2.0 to 3.1 mm). The tab header for board mounting has a locking mechanism where it is compatible with resin coating that is applied to the board for waterproof. It is designed to work with the plug locking function. The solder tail section of tab contact has kink feature. Interacting with the mounting boss with kink feature, the solder tab secures the header on the board firmly during soldering.

The double lock plate is compatible with high-count positions of more than 3 rows. Also, the housing lance design of this connector, featuring no lance on contacts, makes handling of the connector very easy, as there is minimal entanglement of contacts with one another.

**Performance Characteristics**

- Voltage Rating**—300 VAC (for 3.96 mm wire-to-wire, 6.5 mm wire-to-board and 7.92 mm wire-to-board applications)  
50 VAC (for 3.96 mm wire-to-board application)
- Current Rating**—14A max. (Based on initial I-rise vs. current testing using 16 AWG wire in a 2-position connector)
- Fine Rating**—1 mV, 1 $\alpha$ A min.
- Operating Temperature**— $-30^{\circ}$  ~  $+105^{\circ}$ C

**Technical Documents**

- Product Specifications**  
108-5410  
108-5439 (SMT)
- Application Specification**  
114-5175
- Instruction Sheet**  
411-5638

**Power Double Lock (PDL) Connectors (Wire-to-Board and Wire-to-Wire) (Continued)**

**Quick Reference Chart for Mating Part Numbers**

**Quick Reference Chart**

| Plug Connector (Wire Side)              |                  |  | Mating Connectors (Wire and PC Board Mount Side) |  |  |
|---|------------------|--|--|--|--|
| No. of Pos.                             | Housing Part No. | Part No. of Applicable Double Lock Plate | No. of Pos.                                      | Part No. of Cap Housing and Tab Header       | Part No. of Applicable Double Lock Plate |
| <b>■ 3.96 mm and 7.92 mm Centerline</b> |                  |  |  |  |  |
| 1                                       | 316768-□         | 316770-1x1                               | 1  | 316769-□ (Free-Hanging)                      | 316770-1x1                               |
| 2                                       | 177898-□         | 177918-1x1                               | 2  | 179463-□ (Free-Hanging)                      | 177918-1x1                               |
|   |                  |  |  | 177906-□ (Panel Mount)                       | —  |
| 3                                       | 177899-□         | 177919-1x1                               | 3  | 179838-□ (PC Board Mount)                    | —  |
|   |                  |  |  | 179464-□ (Free-Hanging)                      | 177919-1x1                               |
|   |                  |  |  | 177907-□ (Panel Mount)                       | —  |
| 4 (1 Row)                               | 316501-□         | 177920-1x1                               | 4  | 179839-□ (PC Board Mount)                    | —  |
|   |                  |  |  | 179844-□ (PC Board Mount 7.92 mm Centerline) | —  |
| 4 (2 Rows)                              | 177900-□         | 177918-1x2                               | 4  | 316502-□ (Panel Mount)                       | 177920-1x1                               |
|   |                  |  |  | 179465-□ (Free-Hanging)                      | 177918-1x2                               |
|   |                  |  |  | 177908-□ (Panel Mount)                       | —  |
| 6                                       | 177901-□         | 177919-1x2                               | 6  | 179840-□ (PC Board Mount)                    | —  |
|   |                  |  |  | 179466-□ (Free-Hanging)                      | 177919-1x2                               |
|   |                  |  |  | 177909-□ (Panel Mount)                       | —  |
| 8                                       | 177902-□         | 177920-1x2                               | 8  | 179841-□ (PC Board Mount)                    | —  |
|   |                  |  |  | 179467-□ (Free-Hanging)                      | 177920-1x2                               |
| 9                                       | 177903-□         | 177919-1x3                               | 9  | 917845-□ (PC Board Mount)                    | —  |
| 10                                      | 177904-□         | 177921-1x2                               | 10   | 177911-□ (Panel Mount)                       | 177919-1x3                               |
| 12                                      | 177905-□         | 177920-1x3                               | 12   | 177912-□ (Panel Mount)                       | 177921-1x2                               |
|   |                  |  |  | 177913-□ (Panel Mount)                       | 177920-1x3                               |
|   |                  |  |  | 1903720-1 (Free-Hanging)                     | 177920-1x3                               |
| <b>■ 6.5 mm and 13.0 mm Centerline</b>  |                  |  |  |  |  |
| 2                                       | 1939344-1        | 316061-1x1                               | 2  | 1939343-1 (Panel Mount)                      | —  |
| 3                                       | 179938-□         | 316062-1x1                               | 3  | 179846-□ (PC Board Mount)                    | —  |
|   |                  |  |  | 179944-□ (PC Board Mount/SMT)                | —  |
| —                                       | —                | —  | 2  | 917745-□ (PC Board Mount 13 mm Centerline)   | —  |
| 4 (1 Row)                               | 179939-□         | 316063-1x1                               | 4  | 9139343-1-□ (Panel Mount)                    | —  |
|   |                  |  |  | 179847-□ (PC Board Mount)                    | —  |
| 4 (2 Rows)                              | 179861-□         | 316061-1x2                               | 4  | 179945-□ (PC Board Mount/SMT)                | —  |
|   |                  |  |  | 179848-□ (PC Board Mount)                    | —  |
|   |                  |  |  | 1903486-1 (Panel Mount)                      | —  |
| 6                                       | 179862-□         | 316062-1x2                               | 6  | 179849-□ (PC Board Mount)                    | —  |
|   |                  |  |  | 1903487-1 (Panel Mount)                      | —  |
| 12                                      | 917354-□         | 353891-1x2                               | 12   | 917353-□ (PC Board Mount)                    | —  |

\*For details on 6.5 mm and 13.0 mm Centerline products, contact Technical Support

**Note: All part numbers are RoHS Compliant.**

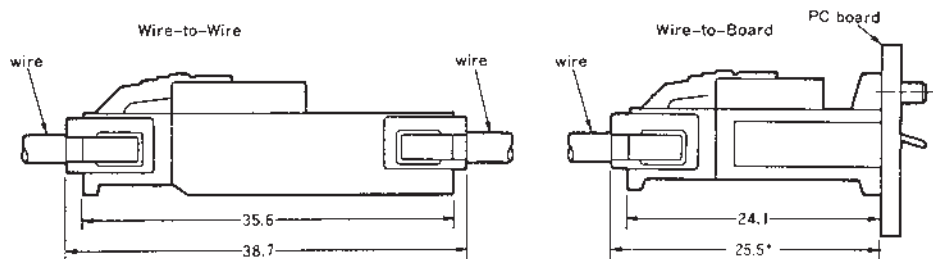

**Note:** All dimensions shown are metric.

High Density

Power Double Lock (PDL) Connectors  
.156 [3.96], .256 [6.50], .312 [7.92] and .512 [13.00] Centerlines

**Power Double Lock (PDL) Connectors (Wire-to-Board and Wire-to-Wire) (Continued)**

**Contacts and Product Composition**

**Contacts**

**Material and Finish**

Pre-tinned copper alloy

Receptacle for Plug Housing,  
Tab for Cap Housing



| Wire Range |                 | Ins. Dia.<br>(Note) | Contact Part No. |           |          |          | Applicator Part No. | CERTI-CRIMP II Hand Tool Part No. |
|------------|-----------------|---------------------|------------------|-----------|----------|----------|---------------------|-----------------------------------|
| AWG        | mm <sup>2</sup> |                     | Receptacle       |           | Tab      |          |                     |                                   |
| 26-22      | 0.14~0.34       | 1.30~2.00           | 177914-1         | 179592-1  | 177916-1 | 179594-1 | 680283-X            | 91567-1                           |
|            |                 |                     | 177914-2*        | 179592-2* |          |          |                     |                                   |
| 20-16      | 0.51~1.38       | 2.00~3.10           | 177915-1         | 179593-1  | 177917-1 | 179595-1 | 680286-X            | 91569-1                           |
|            |                 |                     | 177915-2*        | 179593-2* |          |          |                     |                                   |

**Note:** Maximum diameter is 2.8 mm when Double Lock Plate is used.

\*Part Number suffix -2 represents high contact pressure type.

Extraction Tool P/N : 234912-1 (For receptacle contact)  
234914-1 (For tab contact)

**Note:** Contact the Tooling Assistance Center (TAC) at 1-800-722-1111 for Applicator Part Number.

**Positive mounting achieved with Double Lock mechanism.**

- ① Contact is partially-mounted.
- ② Double Lock Plate is set.
- ③ Contact is fully pushed in as Double Lock Plate is pressed.

**Product Composition**

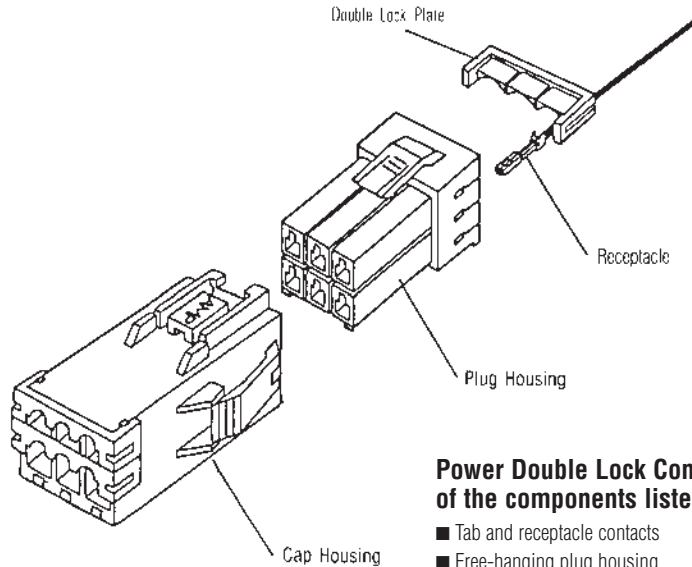

**Power Double Lock Connector is composed of the components listed below:**

- Tab and receptacle contacts
- Free-hanging plug housing
- Free-hanging cap housing
- Panel mount cap housing
- PC Board-mount tab header
- Double Lock Plate

**Note:** All dimensions shown are metric.

**Note:** All part numbers are RoHS Compliant.

**Power Double Lock (PDL) Connectors (Wire-to-Board and Wire-to-Wire) (Continued)**

**3.96 mm Centerline Free-Hanging Plug Housing**

**1 Circuit**

Wire-to-Wire

Material—UL94V-0, 6/6 Nylon

**Part Number**

- 316768-1 (Natural)
- 316768-2 (Red)
- 316768-4 (Yellow)
- 316768-6 (Blue)
- 316768-9 (Black)

**Related Product Data**

**Receptacle Contacts**—page 61

**Mating Cap Housings**  
(Free-Hanging)—pages 65-66

**Double Lock Plate**—page 71

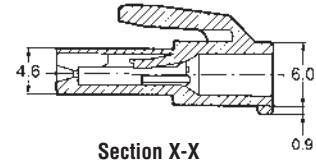
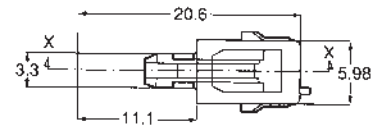

**Section X-X**

**2 Circuits**

Wire-to-Board and Wire-to-Wire

Material—UL94V-0, 6/6 Nylon

**Part Number**

- 177898-1 (Natural)
- 177898-2 (Red)
- 177898-4 (Yellow)
- 177898-6 (Blue)
- 177898-9 (Black)

**Related Product Data**

**Receptacle Contacts**—page 61

**Mating Cap Housings**  
(Free-Hanging)—pages 65-66  
(Panel Mount)—pages 67-70

**Double Lock Plate**—page 71

**Mating Tab Headers**—  
pages 72-74

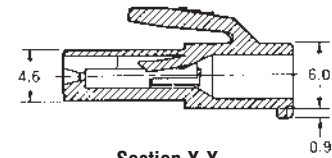
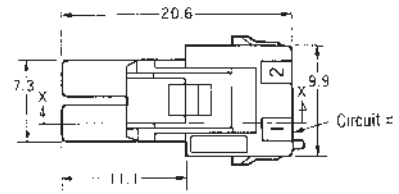
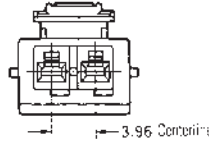

**Section X-X**

**3 Circuits**

Wire-to-Board and Wire-to-Wire

Material—UL94V-0, 6/6 Nylon

**Part Number**

- 177899-1 (Natural)
- 177899-2 (Red)
- 177899-4 (Yellow)
- 177899-6 (Blue)
- 177899-9 (Black)

**Related Product Data**

**Receptacle Contacts**—page 61

**Mating Cap Housings**  
(Free-Hanging)—pages 65-66  
(Panel Mount)—pages 67-70

**Double Lock Plate**—page 71

**Mating Tab Headers**—  
pages 72-74 and  
(2 circuit, 7.92 mm  
centerline)—page 74

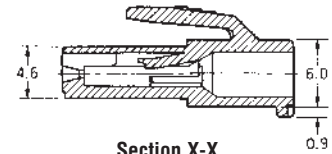
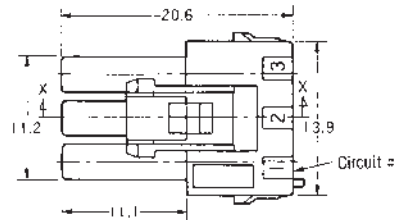
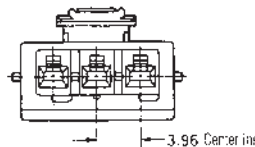

**Section X-X**

**4 Circuits (1 Row)**

Wire-to-Wire

Material—UL94V-0, 6/6 Nylon

**Part Number**

- 316501-1 (Natural)
- 316501-4 (Yellow)
- 316501-6 (Blue)

**Related Product Data**

**Receptacle Contacts**—page 61

**Mating Cap Housings**  
(Panel Mount)—pages 67-70

**Double Lock Plate**—page 71

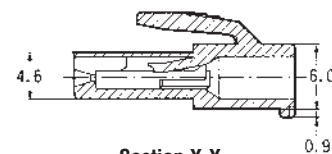
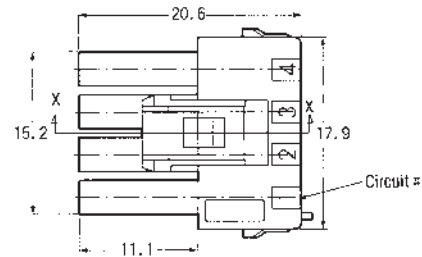
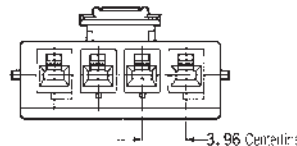

**Section X-X**

**Note:** All dimensions shown are metric.

**Note:** All part numbers are RoHS Compliant.

High Density

Power Double Lock (PDL) Connectors  
.156 [3.96] Centerlines

**Power Double Lock (PDL) Connectors (Wire-to-Board and Wire-to-Wire) (Continued)**

**3.96 mm Centerline Free-Hanging Plug Housing**

**4 Circuits (2 Rows)**

Wire-to-Board and Wire-to-Wire

**Material**

UL94V-0, 6/6 Nylon

**Part Number**

177900-1 (Natural)  
177900-4 (Yellow)  
177900-6 (Blue)

**Lock Type II**

3-177900-1 (Natural)

**Related Product Data**

**Receptacle Contacts**—page 61

**Mating Cap Housings**  
(Free-Hanging)—pages 65-66  
(Panel Mount)—pages 67-70

**Double Lock Plate**—page 71

**Mating Tab Headers**—  
pages 72-74

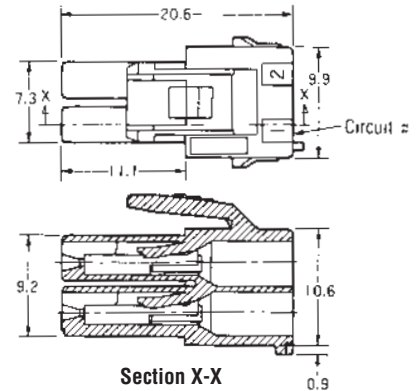
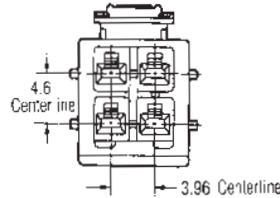

**6 Circuits**

Wire-to-Board and Wire-to-Wire

**Material**

UL94V-0, 6/6 Nylon

**Part Number**

177901-1 (Natural)  
177901-4 (Yellow)  
177901-6 (Blue)

**Lock Type II**

3-177901-1 (Natural)

**Related Product Data**

**Receptacle Contacts**—page 61

**Mating Cap Housings**  
(Free-Hanging)—pages 65-66  
(Panel Mount)—pages 67-70

**Double Lock Plate**—page 71

**Mating Tab Headers**—  
pages 72-74

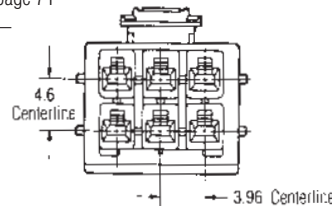

**8 Circuits**

Wire-to-Board and Wire-to-Wire

**Material**

UL94V-0, 6/6 Nylon

**Part Number**

177902-1 (Natural)  
177902-4 (Yellow)  
177902-6 (Blue)

**Lock Type II**

3-177902-1 (Natural)

**Related Product Data**

**Receptacle Contacts**—page 61

**Mating Cap Housings**  
(Free-Hanging)—pages 65-66

**Double Lock Plate**—page 71

**Mating Tab Headers**—pages 72-74



**Note:** All dimensions shown are metric.

**Note:** All part numbers are RoHS Compliant.

**Power Double Lock (PDL) Connectors (Wire-to-Board and Wire-to-Wire) (Continued)**

**3.96 mm Centerline Free-Hanging Plug Housing**

**9 Circuits**

Wire-to-Wire

**Material**

UL94V-0, 6/6 Nylon

**Part Number**

177903-1 (Natural)  
177903-4 (Yellow)  
177903-6 (Blue)

**Lock Type II**

3-177903-1 (Natural)

**Related Product Data**

**Receptacle Contacts**—page 61

**Mating Cap Housings**  
(Panel Mount)—pages 67-70

**Double Lock Plate**—page 71



**10 Circuits**

Wire-to-Wire

**Material**

UL94V-0, 6/6 Nylon

**Part Number**

177904-1 (Natural)  
177904-4 (Yellow)  
177904-6 (Blue)

**Related Product Data**

**Receptacle Contacts**—page 61

**Mating Cap Housings**  
(Panel Mount)—pages 67-70

**Double Lock Plate**—page 71

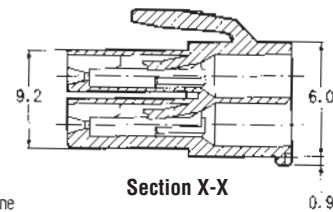
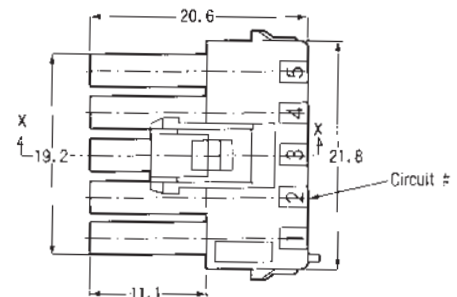
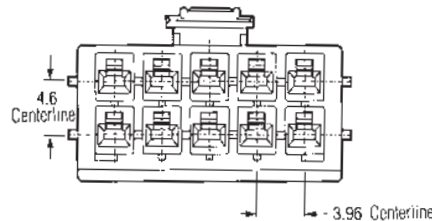

**12 Circuits**

Wire-to-Board and Wire-to-Wire

**Material**

UL94V-0, 6/6 Nylon

**Part Number**

177905-1 (Natural)  
177905-4 (Yellow)  
177905-6 (Blue)

**Related Product Data**

**Receptacle Contacts**—page 61

**Mating Cap Housings**  
(Panel Mount)—pages 67-70

**Double Lock Plate**—page 71

**Mating Tab Headers**—pages 72-74

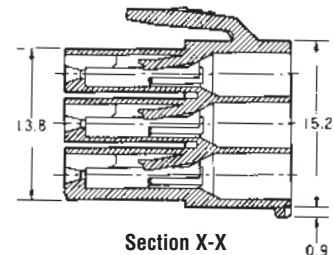
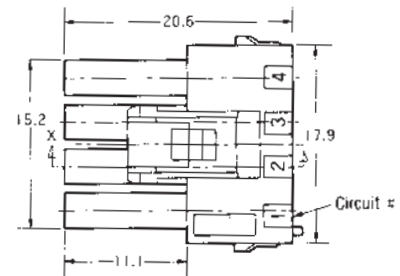
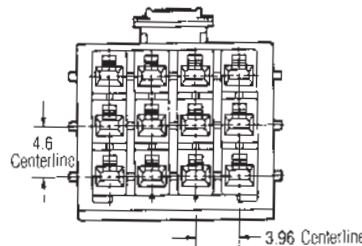

**Note:** All dimensions shown are metric.

**Note:** All part numbers are RoHS Compliant.

High Density  
Power Double Lock (PDL) Connectors  
.156 [3.96] Centerlines



**Power Double Lock (PDL) Connectors (Wire-to-Wire)**

**3.96 mm Centerline Free-Hanging Cap Housing**

**1 Circuit**

Wire-to-Wire

**Material**

UL94V-0, 6/6 Nylon

**Part Number**

- 316769-1 (Natural)
- 316769-2 (Red)
- 316769-4 (Yellow)
- 316769-6 (Blue)
- 316769-9 (Black)

**Related Product Data**

**Tab Contacts**—page 61

**Mating Plug Housings**  
(Free-Hanging)—pages 62-64

**Double Lock Plate**—page 71

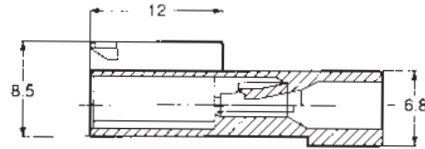
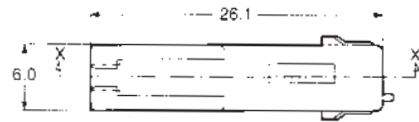
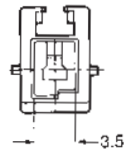

Section X-X

**2 Circuits**

Wire-to-Wire

**Material**

UL94V-0, 6/6 Nylon

**Part Number**

- 179463-1 (Natural)
- 179463-2 (Red)
- 179463-4 (Yellow)
- 179463-6 (Blue)
- 179463-9 (Black)

**Related Product Data**

**Tab Contacts**—page 61

**Mating Plug Housings**  
(Free-Hanging)—pages 62-64

**Double Lock Plate**—page 71

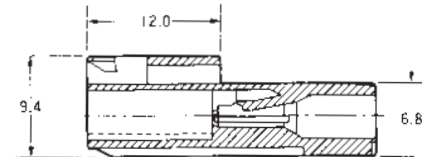
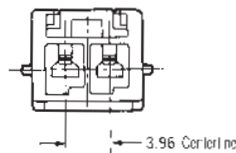

Section X-X

**3 Circuits**

Wire-to-Wire

**Material**

UL94V-0, 6/6 Nylon

**Part Number**

- 179464-1 (Natural)
- 179464-2 (Red)
- 179464-4 (Yellow)
- 179464-6 (Blue)
- 179464-9 (Black)

**Related Product Data**

**Tab Contacts**—page 61

**Mating Plug Housings**  
(Free-Hanging)—pages 62-64

**Double Lock Plate**—page 71

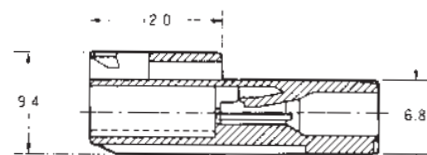
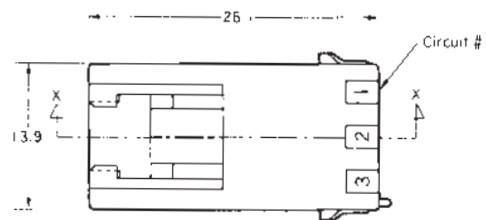
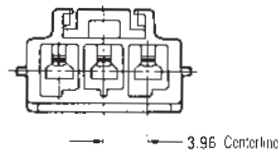

Section X-X

**Note:** All dimensions shown are metric.

**Note:** All part numbers are RoHS Compliant.

**Power Double Lock (PDL) Connectors (Wire-to-Wire) (Continued)**

**3.96 mm Centerline Free-Hanging Cap Housing**

**4 Circuits (2 Rows)**

Wire-to-Wire

**Material**

UL94V-0, 6/6 Nylon

**Part Number**

179465-1 (Natural)  
179465-4 (Yellow)  
179465-6 (Blue)

**Related Product Data**

**Tab Contacts**—page 61

**Mating Plug Housings**  
(Free-Hanging)—pages 62-64

**Double Lock Plate**—page 71



**Section X-X**

**6 Circuits**

Wire-to-Wire

**Material**

UL94V-0, 6/6 Nylon

**Part Number**

179466-1 (Natural)  
179466-4 (Yellow)  
179466-6 (Blue)

**Related Product Data**

**Tab Contacts**—page 61

**Mating Plug Housings**  
(Free-Hanging)—pages 62-64

**Double Lock Plate**—page 71



**Section X-X**

**8 Circuits**

Wire-to-Wire

**Material**

UL94V-0, 6/6 Nylon

**Part Number**

179467-1 (Natural)  
179467-4 (Yellow)  
179467-6 (Blue)

**Related Product Data**

**Tab Contacts**—page 61

**Mating Plug Housings**  
(Free-Hanging)—pages 62-64

**Double Lock Plate**—page 71



**Section X-X**

**12 Circuits**

Wire-to-Board

**Material**

UL94V-0, 6/6 Nylon

**Part Number**

1903720-1 (Natural)

**Related Product Data**

**Tab Contacts**—page 61

**Mating Plug Housings**  
(Free-Hanging)—pages 62-64

**Double Lock Plate**—page 71

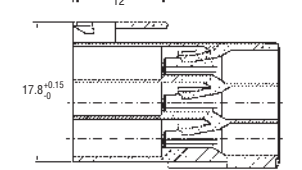
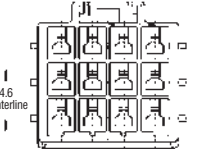

**Section X-X**

**Note:** All dimensions shown are metric.

**Note:** All part numbers are RoHS Compliant.

High Density

Power Double Lock (PDL) Connectors  
.156 [3.96] Centerlines

**Power Double Lock (PDL) Connectors (Wire-to-Wire)** (Continued)

High Density

Power Double Lock (PDL) Connectors  
.156 [3.96] Centerlines

**3.96 mm Centerline Panel Mount Cap Housing**

**2 Circuits**

Wire-to-Wire

Material—UL94V-0, 6/6 Nylon

**Part Number**

- 177906-1 (Natural)
- 177906-2 (Red)
- 177906-4 (Yellow)
- 177906-6 (Blue)
- 177906-9 (Black)

**Related Product Data**

**Tab Contacts**—page 61

**Mating Plug Housings**  
(Free-Hanging)—pages 62-64

**Double Lock Plate**—page 71



**3 Circuits**

Wire-to-Wire

Material—UL94V-0, 6/6 Nylon

**Part Number**

- 177907-1 (Natural)
- 177907-2 (Red)
- 177907-4 (Yellow)
- 177907-6 (Blue)
- 177907-9 (Black)

**Related Product Data**

**Tab Contacts**—page 61

**Mating Plug Housings**  
(Free-Hanging)—pages 62-64

**Double Lock Plate**—page 71



**4 Circuits (1 Row)**

Wire-to-Wire

Material—UL94V-0, 6/6 Nylon

**Part Number**

- 316502-1 (Natural)
- 316502-4 (Yellow)
- 316502-6 (Blue)

**Related Product Data**

**Tab Contacts**—page 61

**Mating Plug Housings**  
(Free-Hanging)—pages 62-64

**Double Lock Plate**—page 71

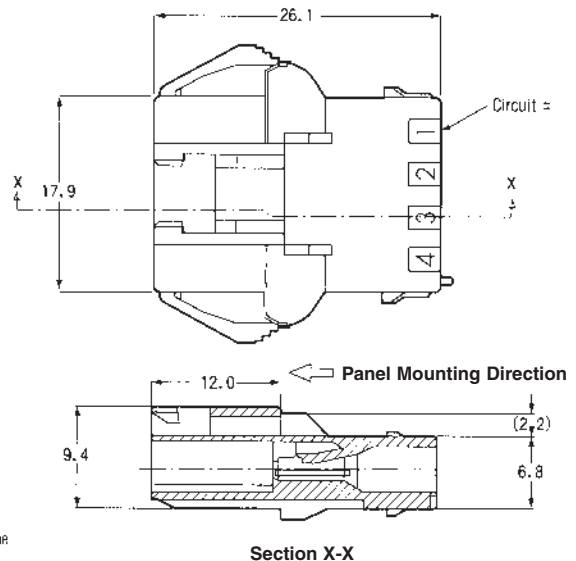

**Note:** All dimensions shown are metric.  
**Note:** All part numbers are RoHS Compliant.

**Power Double Lock (PDL) Connectors (Wire-to-Wire)** (Continued)

**3.96 mm Centerline Panel Mount Cap Housing**

**4 Circuits (2 Rows)**

Wire-to-Wire

**Material**

UL94V-0, 6/6 Nylon

**Part Number**

- 177908-1 (Natural)
- 177908-4 (Yellow)
- 177908-6 (Blue)

**Related Product Data**

**Tab Contacts**—page 61

**Mating Plug Housings**  
(Free-Hanging)—pages 62-64

**Double Lock Plate**—page 71



**Panel Cutout**  
(Applicable Board Thickness: 0.8~2.0 mm)

**Section X-X**

**6 Circuits**

Wire-to-Wire

**Material**

UL94V-0, 6/6 Nylon

**Part Number**

- 177909-1 (Natural)
- 177909-4 (Yellow)
- 177909-6 (Blue)

**Related Product Data**

**Tab Contacts**—page 61

**Mating Plug Housings**  
(Free-Hanging)—pages 62-64

**Double Lock Plate**—page 71

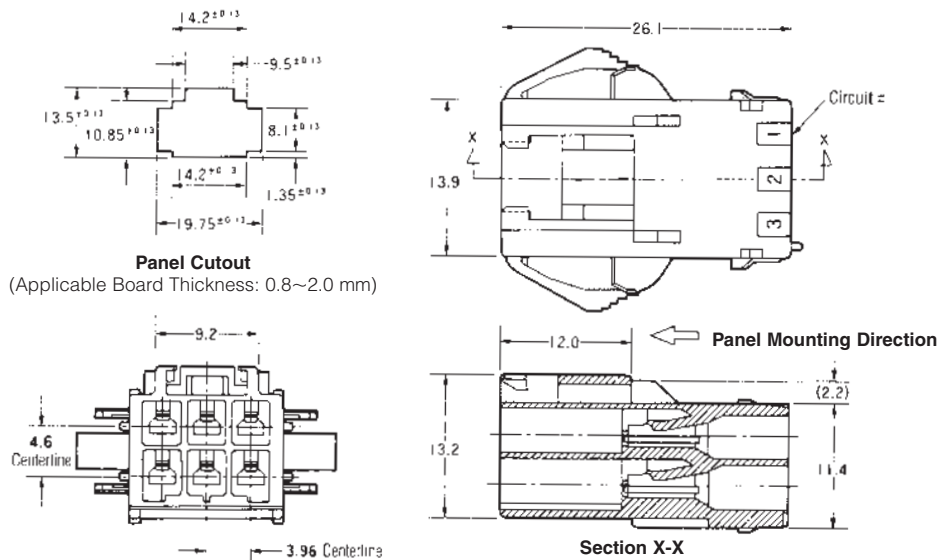

**Panel Cutout**  
(Applicable Board Thickness: 0.8~2.0 mm)

**Section X-X**

**Note:** All dimensions shown are metric.

**Note:** All part numbers are RoHS Compliant.

Power Double Lock (PDL) Connectors .156 [3.96] Centerlines High Density

**Power Double Lock (PDL) Connectors (Wire-to-Wire) (Continued)**

**3.96 mm Centerline Panel Mount Cap Housing**

**9 Circuits**

Wire-to-Wire

**Material**

UL94V-0, 6/6 Nylon

**Part Number**

- 177911-1 (Natural)
- 177911-4 (Yellow)
- 177911-6 (Blue)

**Related Product Data**

**Tab Contacts**—page 61

**Mating Plug Housings**  
(Free-Hanging)—pages 62-64

**Double Lock Plate**—page 71



**For 10 Circuits**

Wire-to-Wire

**Material**

UL94V-0, 6/6 Nylon

**Part Number**

- 177912-1 (Natural)
- 177912-4 (Yellow)
- 177912-6 (Blue)

**Related Product Data**

**Tab Contacts**—page 61

**Mating Plug Housings**  
(Free-Hanging)—pages 62-64

**Double Lock Plate**—page 71



**Note:** All dimensions shown are metric.

**Note:** All part numbers are RoHS Compliant.

**Power Double Lock (PDL) Connectors (Wire-to-Wire) (Continued)**

**3.96 mm Centerline Panel Mount Cap Housing**

**12 Circuits**

**Wire-to-Wire**

**Material**

UL94V-0, 6/6 Nylon

**Part Number**

- 177913-1 (Natural)
- 177913-4 (Yellow)
- 177913-6 (Blue)

**Related Product Data**

**Tab Contacts**—page 61

**Mating Plug Housings**  
(Free-Hanging)—pages 62-64

**Double Lock Plate**—page 71



**Note:** All dimensions shown are metric.

**Note:** All part numbers are RoHS Compliant.

Power Double Lock (PDL) Connectors .156 [3.96] Centerlines High Density

**Power Double Lock (PDL) Connectors (Wire-to-Board and Wire-to-Wire)**

**3.96 mm Centerline Double-Lock Plates**

**Double Lock Plates**

**Material**

UL94V-0, glass filled 6/6 Nylon, natural color

**Part Number**

- 316770-1 (1 Pos.)
- 177918-1 (2 Pos.)
- 177919-1 (3 Pos.)
- 177920-1 (4 Pos.)
- 177921-1 (5 Pos.)

**Related Product Data**

**Plug Housings**—pages 62-64

**Cap Housings**—pages 65-70



For 1 Circuit

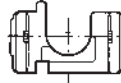

For 2 Circuits

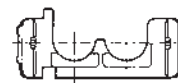

For 3 Circuits



For 4 Circuits

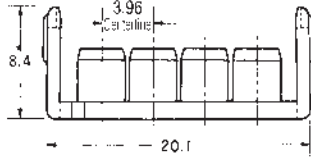

For 5 Circuits

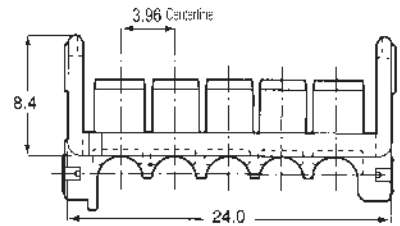

| No. of Pos. | Applicable Housing Part No. |              |             | Double Lock Plate |               |
|-------------|-----------------------------|--------------|-------------|-------------------|---------------|
|             | Plug Housing                | Cap Housing  |             | Part Number       | Required Qty. |
|             |                             | Free-Hanging | Panel Mount |                   |               |
| 1           | 316768-□                    | 316769-□     | —           | 316770-1 (1 Pos.) | 1             |
| 2           | 177898-□                    | 179463-□     | 177906-□    | 177918-1 (2 Pos.) | 1             |
| 3           | 177899-□                    | 179464-□     | 177907-□    | 177919-1 (3 Pos.) | 1             |
| 4 (1 Row)   | 316501-□                    | —            | 316502-□    | 177920-1 (4 Pos.) | 1             |
| 4 (2 Rows)  | 177900-□                    | 179465-□     | 177908-□    | 177918-1 (2 Pos.) | 2             |
| 6           | 177901-□                    | 179466-□     | 177909-□    | 177919-1 (3 Pos.) | 2             |
| 8           | 177902-□                    | 179467-□     | —           | 177920-1 (4 Pos.) | 2             |
| 9           | 177903-□                    | —            | 177911-□    | 177919-1 (3 Pos.) | 3             |
| 10          | 177904-□                    | —            | 177912-□    | 177921-1 (5 Pos.) | 2             |
| 12          | 177905-□                    | —            | 177913-□    | 177920-1 (4 Pos.) | 3             |

**Note:** All dimensions shown are metric.

**Note:** All part numbers are RoHS Compliant.

**Power Double Lock (PDL) Connectors (Wire-to-Board)**

**3.96 mm Centerline for PC Board Mount Tab Header, Vertical**

**2 Circuits**

Wire-to-Board

**Material and Finish**

**Housing**—UL 94V-0, glass filled 6/6 Nylon

**Contact**—Copper alloy, Tin plated

**Part Number**

- 179838-1 (Natural)
- 179838-2 (Red)
- 179838-4 (Yellow)
- 179838-6 (Blue)
- 179838-9 (Black)

**Tube** (53 ea.)—316299-□

**Related Product Data**

**Mating Plug Housing**  
(Free-Hanging)—pages 62-64



**PC Board Layout**  
(Applicable Board Thickness: 1.6 mm)



**3 Circuits**

Wire-to-Board

**Material and Finish**

**Housing**—UL 94V-0, glass filled 6/6 Nylon

**Contact**—Copper alloy, Tin plated

**Part Number**

- 179839-1 (Natural)
- 179839-2 (Red)
- 179839-4 (Yellow)
- 179839-6 (Blue)
- 179839-9 (Black)

**Related Product Data**

**Mating Plug Housing**  
(Free-Hanging)—pages 62-64

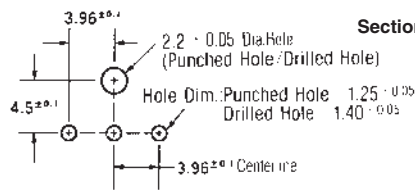

**PC Board Layout**  
(Applicable Board Thickness: 1.6 mm)

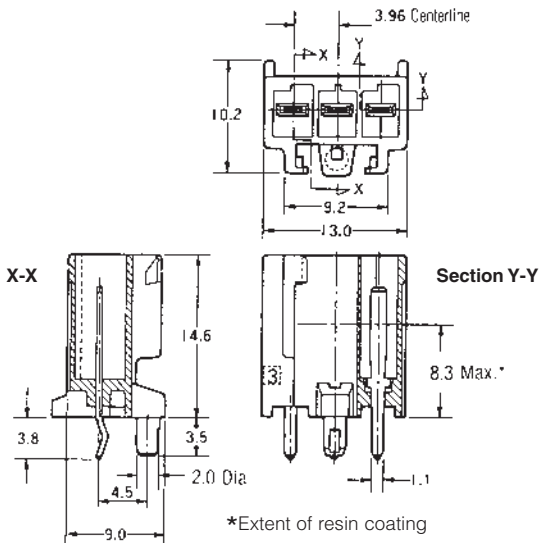

**Note:** All dimensions shown are metric.

**Note:** All part numbers are RoHS Compliant.



**Power Double Lock (PDL) Connectors (Wire-to-Board) (Continued)**

**3.96 mm Centerline for PC Board Mount Tab Header, Vertical (Continued)**

**4 Circuits (2 Rows)**

Wire-to-Board

**Material and Finish**

**Housing**—UL 94V-0, glass filled 6/6 Nylon.

**Contact**—Copper alloy, Tin plated

**Part Number**

- 179840-1 (Natural)
- 179840-4 (Yellow)
- 179840-6 (Blue)

**Related Product Data**

**Mating Plug Housings**  
(Free-Hanging)—pages 62-64

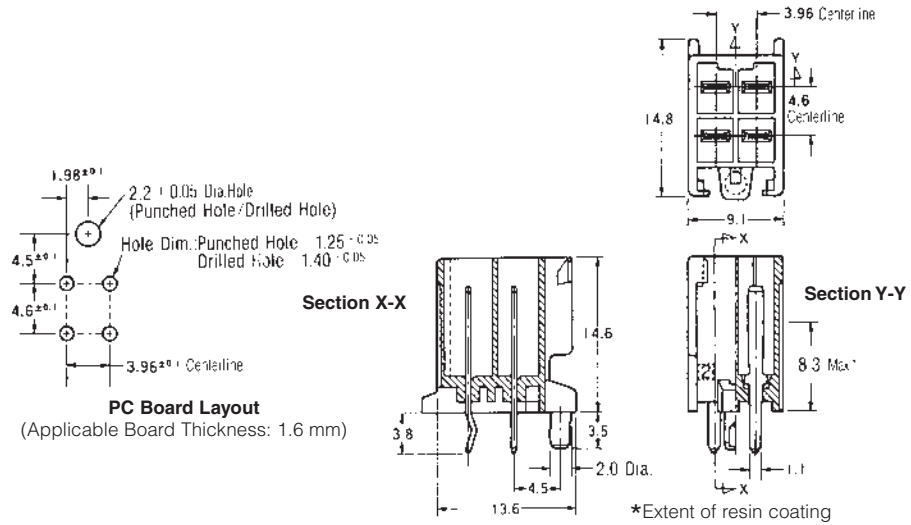

**6 Circuits**

Wire-to-Board

**Material and Finish**

**Housing**—UL 94V-0, glass filled 6/6 Nylon.

**Contact**—Copper alloy, Tin plated

**Part Number**

- 179841-1 (Natural)
- 179841-4 (Yellow)
- 179841-6 (Blue)

**Related Product Data**

**Mating Plug Housings**  
(Free-Hanging)—pages 62-64

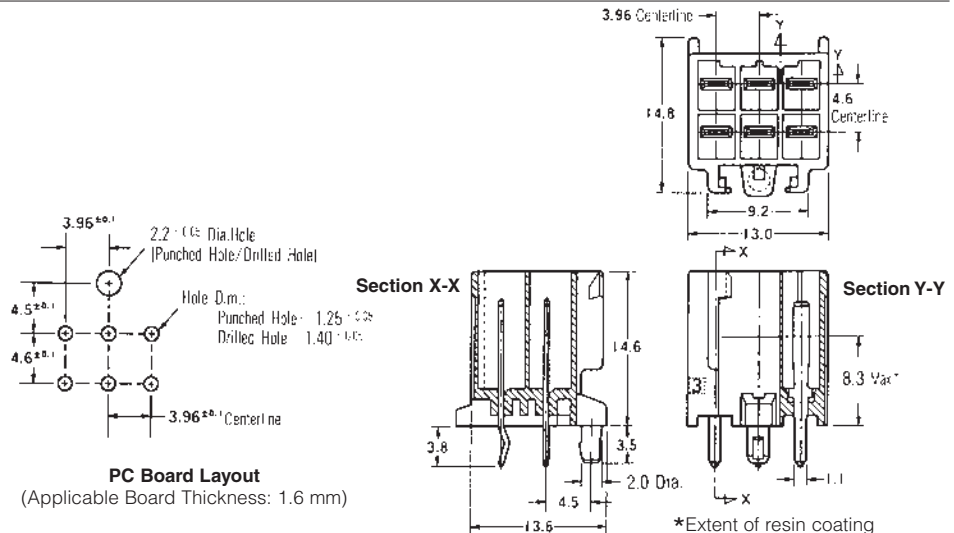

**8 Circuits**

Wire-to-Board

**Material and Finish**

**Housing**—UL 94V-0, glass filled 6/6 Nylon.

**Contact**—Copper alloy, Tin plated

**Part Number**

- 917845-1 (Natural)
- 917845-4 (Yellow)
- 917845-6 (Blue)

**Related Product Data**

**Mating Plug Housings**  
(Free-Hanging)—pages 62-64



**Note:** All dimensions shown are metric.

**Note:** All part numbers are RoHS Compliant.

**Power Double Lock (PDL) Connectors (Wire-to-Board) (Continued)**

**3.96 mm Centerline for PC Board Mount Tab Header, Vertical**

**12 Circuits**  
**Wire-to-Board**

**Material and Finish**  
**Housing**—UL 94V-0, glass filled 6/6 Nylon  
**Contact**—Copper alloy, Tin plated

**Part Number**  
179843-1 (Natural)  
179843-4 (Yellow)  
179843-6 (Blue)

**Related Product Data**  
**Mating Plug Housings**  
(Free-Hanging)—pages 62-64



**PC Board Layout**  
(Applicable Board Thickness: 1.6 mm)



**Section X-X**

**Section Y-Y**

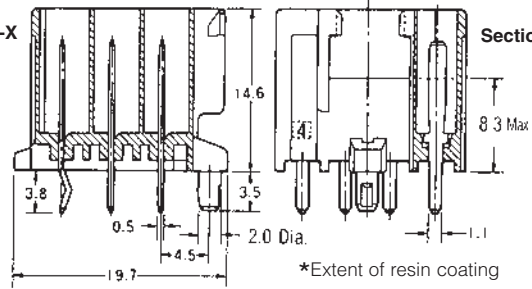

**3.96 mm Centerline (2 Pos. = 7.92 mm Centerline) for PC Board Mount Tab Header, Vertical**

**2 Circuits**  
**Wire-to-Board**

**Material and Finish**  
**Housing**—UL 94V-0, glass filled 6/6 Nylon  
**Contact**—Copper alloy, Tin plated

**Part Number**  
With kink  
179844-1 (Natural)  
179844-2 (Red)  
179844-4 (Yellow)  
179844-6 (Blue)  
179844-9 (Black)

Without kink  
9-179844-1 (Natural)  
9-179844-6 (Blue)

**Related Product Data**  
**Mating 3-Circuit Plug Housings**  
(Free-Hanging)—page 62



**PC Board Layout**  
(Applicable Board Thickness: 1.6 mm)

**Section X-X**

**Section Y-Y**



**Note:** All dimensions shown are metric.  
**Note:** All part numbers are RoHS Compliant.

**Power Double Lock (PDL) Connectors (Wire-to-Board and Wire-to-Wire) (Continued)**

High Density  
Power Double Lock (PDL) Connectors  
.256 [6.50] Centerlines

**6.5 mm Centerline Free-Hanging Plug Housing**

**2 Circuits**  
**Wire-to-Board**

**Material**  
UL 94V-0, 6/6 Nylon

**Part Number**  
1939344-1 (Natural)

**Related Product Data**  
**Receptacle Contacts**—page 61  
**Double Lock Plate**—page 77  
**Mating Tab Headers**—pages 79-81

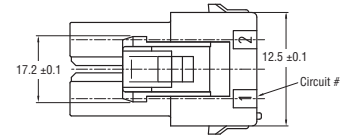

**3 Circuits**  
**Wire-to-Board**

**Material**  
UL 94V-0, 6/6 Nylon

**Part Number**  
179938-1 (Natural)  
179938-2 (Red)  
179938-4 (Yellow)  
179938-6 (Blue)  
179938-9 (Black)

**Related Product Data**  
**Receptacle Contacts**—page 61  
**Double Lock Plate**—page 77  
**Mating Tab Headers**—pages 79-81



**4 Circuits (1 Row)**  
**Wire-to-Board**

**Material**  
UL 94V-0, 6/6 Nylon

**Part Number**  
179939-1 (Natural)  
179939-4 (Yellow)  
179939-6 (Blue)  
179939-9 (Black)

**Related Product Data**  
**Receptacle Contacts**—page 61  
**Double Lock Plate**—page 77  
**Mating Tab Headers**—pages 79-81



**4 Circuits (2 Rows)**  
**Wire-to-Board**

**Material**  
UL 94V-0, 6/6 Nylon

**Part Number**  
**Housing Lock Type A**  
179861-1 (Natural)  
179861-4 (Yellow)  
179861-6 (Blue)  
**Housing Lock Type B**  
2-179861-1 (Natural)  
2-179861-4 (Yellow)  
2-179861-6 (Blue)

**Related Product Data**  
**Receptacle Contacts**—page 61  
**Double Lock Plate**—page 77  
**Mating Tab Headers**—pages 79-81



**Note:** All dimensions shown are metric.  
**Note:** All part numbers are RoHS Compliant.

**Power Double Lock (PDL) Connectors (Wire-to-Board and Wire-to-Wire) (Continued)**

**6.5 mm Centerline Free-Hanging Plug Housing**

**6 Circuits**

**Wire-to-Board**

**Material**

UL 94V-0, 6/6 Nylon

**Part Number**

Housing Lock Type A  
179862-1 (Natural)  
179862-4 (Yellow)  
179862-6 (Blue)

**Housing Lock Type B**

2-179862-1 (Natural)  
2-179862-4 (Yellow)  
2-179862-6 (Blue)

**Related Product Data**

**Receptacle Contacts**—page 61

**Double Lock Plate**—page 77

**Mating Tab Headers**—pages 79-81

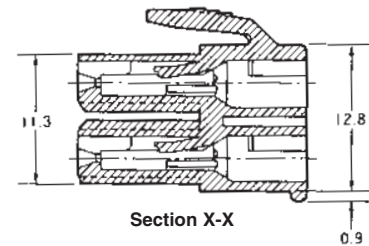
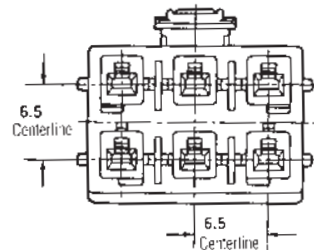
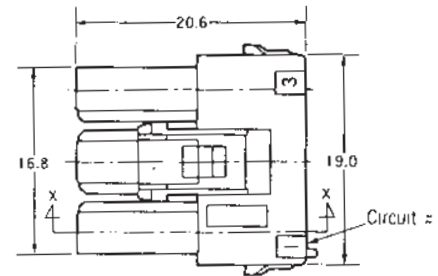

**12 Circuits**

**Wire-to-Board**

**Material**

UL 94V-0, 6/6 Nylon.

**Part Number**

Housing Lock Type A  
917354-1 (Natural)  
Housing Lock Type B  
2-917354-1 (Natural)

**Related Product Data**

**Receptacle Contacts**—page 61

**Double Lock Plate**—page 77

**Mating Tab Headers**—pages 79-81

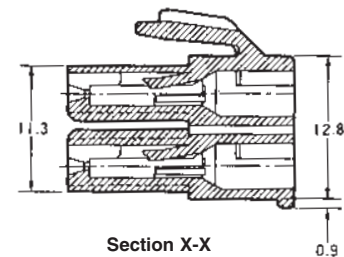

**Note:** All dimensions shown are metric.

**Note:** All part numbers are RoHS Compliant.

**Power Double Lock (PDL) Connectors (Wire-to-Board and Wire-to-Wire) (Continued)**

**6.5 mm Centerline Double-Lock Plates**

**Material**  
UL94V-0, glass filled  
6/6 Nylon, natural color

**Part Number**  
316061-1 (2-Circuits)  
316062-1 (3-Circuits)  
316063-1 (4-Circuits)  
353891-1 (6-Circuits)

**Related Product Data**  
**Plug Housings**  
(Free-Hanging)—pages 75-76

**For 2 Circuits**  
**Wire-to-Board**



**For 3 Circuits**  
**Wire-to-Board**



**For 4 Circuits**  
**Wire-to-Board**



**For 6 Circuits**  
**Wire-to-Board**



| No. of Pos. | Applicable Plug Housing Part No. | Double Lock Plate |               |
|-------------|----------------------------------|-------------------|---------------|
|             |                                  | Part Number       | Required Qty. |
| 3           | 179938-□                         | 316062-1          | 1             |
| 4 (1 Row)   | 179939-□                         | 316063-1          | 1             |
| 4 (2 Rows)  | 179861-□                         | 316061-1          | 2             |
| 6           | 179862-□                         | 316062-1          | 2             |
| 12          | 917354-□                         | 353891-1          | 2             |

**Note:** All dimensions shown are metric.  
**Note:** All part numbers are RoHS Compliant.

**Power Double Lock (PDL) Connectors (Wire-to-Board) (Continued)**

**6.5 mm Centerline Panel Mount Cap Housing**

**2 Circuits**  
Wire-to-Wire

**Material and Finish**  
**Housing**—UL 94V-0, glass filled 6/6 Nylon  
**Contact**—Copper alloy, Tin plated

**Part Number**  
1939343-1 (Natural)

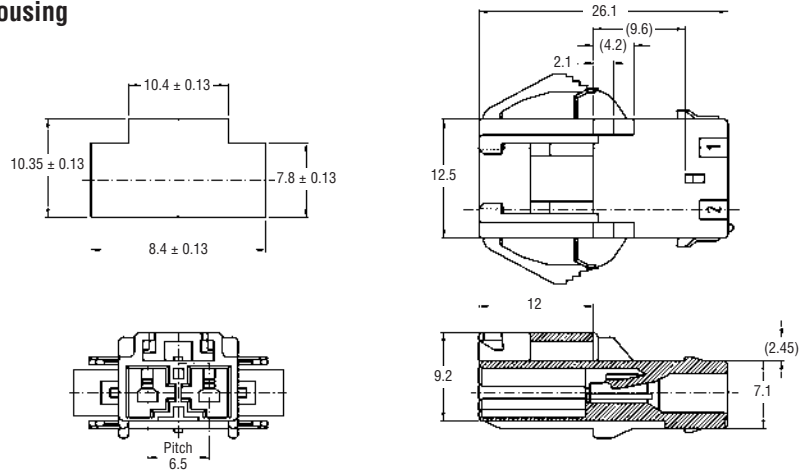

**4 Circuits**  
Wire-to-Wire

**Material and Finish**  
**Housing**—UL 94V-0, glass filled 6/6 Nylon  
**Contact**—Copper alloy, Tin plated

**Part Number**  
1903486-1 (Natural)

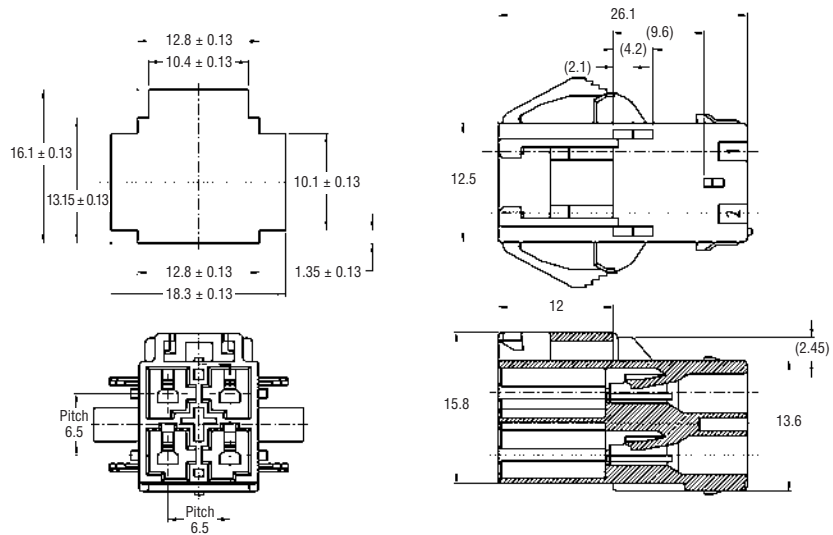

**6 Circuits**  
Wire-to-Wire

**Material and Finish**  
**Housing**—UL 94V-0, glass filled 6/6 Nylon  
**Contact**—Copper alloy, Tin plated

**Part Number**  
1903487-1 (Natural)



**Note:** All dimensions shown are metric.  
**Note:** All part numbers are RoHS Compliant

High Density

Power Double Lock (PDL) Connectors  
2.56 [6.50] Centerlines

**Power Double Lock (PDL) Connectors (Wire-to-Board) (Continued)**

High Density

Power Double Lock (PDL) Connectors  
.256 [6.50] and .512 [13.00] Centerlines

**6.5 mm Centerline (2 Pos.=13 mm Centerline) PC Board Mount Tab Header, Vertical**

**3 Circuits**

Wire-to-Board

**Material and Finish**

**Housing**—UL 94V-0, glass filled 6/6 Nylon

**Contact**—Copper alloy, Tin plated

**Part Number**

- 179846-1 (Natural)
- 179846-4 (Yellow)
- 179846-6 (Blue)

**Related Product Data**

**Mating Plug Housings**  
(Free-Hanging)—pages 75-76

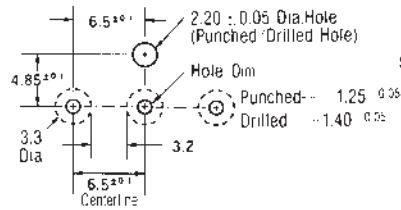

**PC Board Layout**

(Applicable Board Thickness: 1.6 mm)

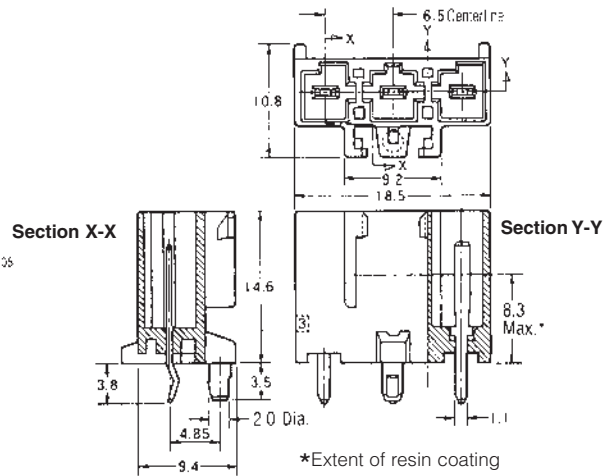

**2 Circuits**

(13 mm Centerline)

Wire-to-Board

**Material and Finish**

**Housing**—UL 94V-0, glass filled 6/6 Nylon

**Contact**—Copper alloy, Tin plated

**Part Number**

- 917745-1 (Natural)
- 917745-4 (Yellow)
- 917745-6 (Blue)

Tube (26 ea.)—917746-□

**Related Product Data**

**Mating 3-Circuit Plug Housings**  
(Free-Hanging)—page 75

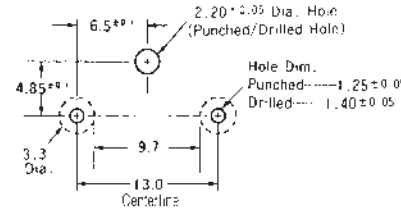

**PC Board Layout**

(Applicable Board Thickness: 1.6 mm)

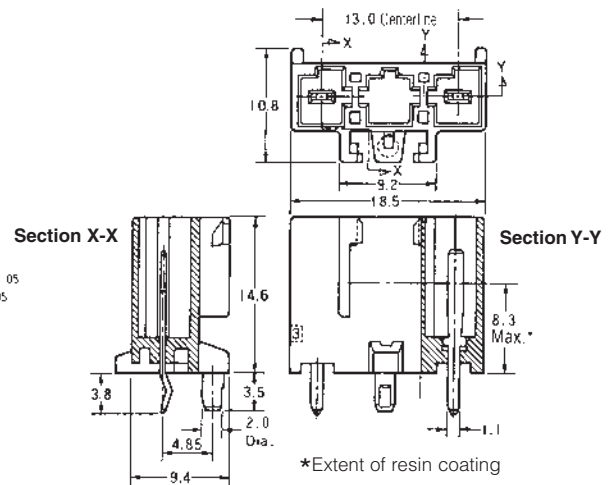

**4 Circuits (1 Row)**

Wire-to-Board

**Material and Finish**

**Housing**—UL 94V-0, glass filled 6/6 Nylon

**Contact**—Copper alloy, Tin plated

**Part Number**

- 179847-1 (Natural)
- 179847-4 (Yellow)
- 179847-6 (Blue)

**Related Product Data**

**Mating Plug Housings**  
(Free-Hanging)—pages 75-76

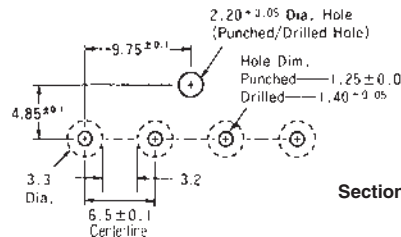

**PC Board Layout**

(Applicable Board Thickness: 1.6 mm)

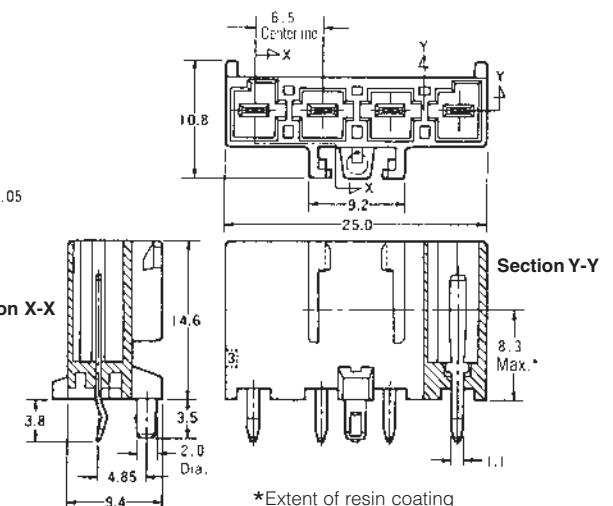

**Note:** All dimensions shown are metric.

**Note:** All part numbers are RoHS Compliant.

**Power Double Lock (PDL) Connectors (Wire-to-Board) (Continued)**

**6.5 mm Centerline PC Board Mount Tab Header, Vertical**

**4 Circuits (2 Rows)**

Wire-to-Board

**Material and Finish**

**Housing**—UL 94V-0, glass filled 6/6 Nylon

**Contact**—Copper alloy, Tin plated

**Part Number**

- 179848-1 (Natural)
- 179848-4 (Yellow)
- 179848-6 (Blue)

Tube (40 ea.)—917747-□

**Related Product Data**

**Mating Plug Housings**  
(Free-Hanging)—pages 75-76

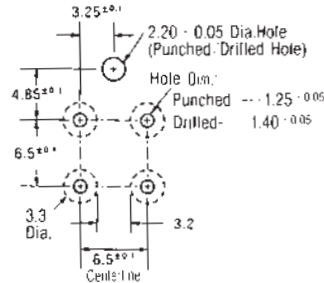

**PC Board Layout**

(Applicable Board Thickness: 1.6 mm)

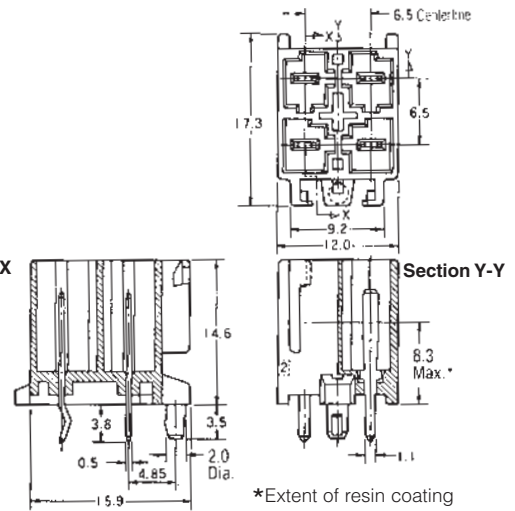

**6 Circuits**

Wire-to-Board

**Material and Finish**

**Housing**—UL 94V-0, glass filled 6/6 Nylon

**Contact**—Copper alloy, Tin plated

**Part Number**

- 179849-1 (Natural)
- 179849-4 (Yellow)
- 179849-6 (Blue)

**Related Product Data**

**Mating Plug Housings**  
(Free-Hanging)—pages 75-76



**PC Board Layout**

(Applicable Board Thickness: 1.6 mm)



**Note:** All dimensions shown are metric.

**Note:** All part numbers are RoHS Compliant.



**Power Double Lock (PDL) Connectors (Wire-to-Board)** (Continued)

**6.5 mm Centerline PC Board Mount Tab Header, Vertical**

**12 Circuits**

**Wire-to-Board**

**Material and Finish**

**Housing**—UL 94V-0,  
glass filled 6/6 Nylon

**Contact**—Copper alloy, Tin plated

**Part Number**

With Boss, With kink  
917353-1 (Natural)

Without Boss, Without kink  
3-917353-1 (Natural)

**Related Product Data**

**Mating Plug Housings**  
(Free-Hanging)—pages 75-76



**PC Board Layout**  
(Applicable Board Thickness: 1.6 mm)

**Note:** All dimensions shown are metric.  
**Note:** All part numbers are RoHS Compliant.

---

**Engineering Notes**

---



## Mini-Universal MATE-N-LOK Connectors

### Product Facts

- Compact, durable housings
- Pins and sockets can be accommodated in the same housings
- Contacts fully protected in the housings. Both pins and sockets can be used on the power supply wiring
- Fully polarized to provide proper plug-to-cap mating incorporating a positive locking mechanism to help prevent accidental disengagement of mated connectors. Also facilitates panel mounting
- Free-hanging or panel mount
- Housings available in 1, 2, 3, 4, 6, 9, 12 and 15 circuit configuration for wire-to-wire connection
- Connectors can be mounted to .031-.079 [0.79-2.00] thick panels
- Printed circuit board pin headers are available in 2 thru 24 circuit vertical and right-angle configurations
- Hermaphroditic housings available in 2, 3 and 4 circuits for free-hanging applications
- Low insertion/extraction forces
- Contacts accept wire size range 30-16 AWG [.05-1.2 mm<sup>2</sup>]
- Test probe contacts available
- .163 [4.14] centerline spacing
- Not for interrupting current
- Recognized under the Component Program of Underwriters Laboratories Inc., File No. E28476
- Certified by Canadian Standards Association, File No. LR 7189

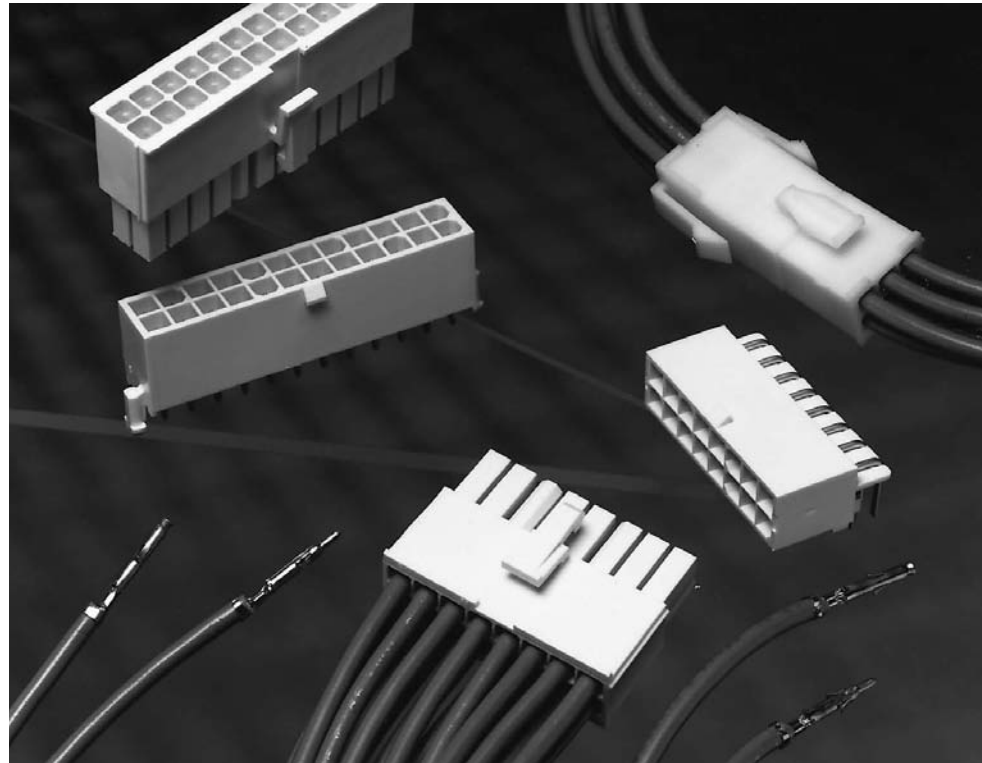

### Performance Characteristics

The Mini-Universal MATE-N-LOK Connector performance characteristics found on pages 83-84 are based on free-hanging and panel mount connectors, loaded with contacts crimped on stranded wire.

**Low Level Termination Resistance**  
20 milliohms max. total resistance between wire crimps of a mated pin and socket

**Dielectric Withstanding Voltage**—  
1.5 KVAC between adjacent circuits

**Insulation Resistance**—  
1000 megohms minimum between adjacent circuits

**Voltage Rating**—600 V AC or DC

**Contact Retention**—8 lb. min. per contact

**Durability**—20 cycles, mating and unmating

### Technical Documents

| Product Specifications |  |
|------------------------|--|
| 108-1542               | Mini-Universal MATE-N-LOK Connectors           |
| 108-1543               | Mini-Universal MATE-N-LOK Headers              |
| 108-5151               | Mini-Universal MATE-N-LOK Connectors (UL94V-2) |
| 108-5138               | Mini-Universal MATE-N-LOK Connectors (UL94V-0) |

### Application Specification

|           |                                      |
|-----------|--------------------------------------|
| 114-16017 | Mini-Universal MATE-N-LOK Connectors |
|-----------|--------------------------------------|

### Instruction Sheets

|          |                                      |
|----------|--------------------------------------|
| 408-3234 | Mini-Universal MATE-N-LOK Connectors |
| 411-5105 | Mini-Universal MATE-N-LOK Connectors |

**Mini-Universal MATE-N-LOK Connectors** (Continued)

**Performance Characteristics** (Continued)

**Maximum Current**—Maximum current rating of Mini-Universal MATE-N-LOK connectors is limited by the maximum operating temperature of the housings which is 105°C including the temperature rise of the contacts which is a maximum of 30°C. There are several variables which have a direct effect on this maximum current-carrying capability for a given connector and must be considered for each application. These variables are:

**Wire Size**—Larger diameter wire will carry more current since it has less internal resistance to current flow and thus generates less heat. Longer wire lengths also enhance current-carrying capabilities since the wire conducts heat away from the connector.

**Connector Size**—In general, the more circuits in a connector, the less current can be carried.

**Ambient Temperature**—The higher the ambient temperature, the less current can be carried in any given connector.

**Printed Wiring Board Conductor Size**—The finished trace conductor width and thickness should be maximized to allow for the greatest current-carrying capacity and heat dissipation.

Mini-Universal MATE-N-LOK connectors also will withstand the following tests:

**Housing Panel Retention**—  
26 lb. min.

**Housing Lock Strength**—9 lb. min.

**Thermal Shock**— -55°C to +105°C

**Temperature-Humidity Cycling**—  
25°C to 65°C at 95 RH

**Vibration**—10-55-10 cycles per minute at .06 inch total excursion

**Physical Shock**—18 drops,  
50 G half-sine at 11 milliseconds

**Current Rating Verification for 30°C Maximum Temperature Rise 100% Energized**

**Wire-to-Wire Mini-Universal MATE-N-LOK Connectors — Calculated Current Table**

| Number of Circuits | Wire AWG |      |      |      |      |      |      |
|--------------------|----------|------|------|------|------|------|------|
|                    | 16       | 18   | 20   | 22   | 24   | 26   | 30   |
| 2                  | 9.50     | 9.00 | 7.50 | 6.00 | 5.00 | 4.00 | 3.00 |
| 3                  | 8.50     | 8.00 | 7.00 | 5.50 | 4.50 | 4.00 | 3.00 |
| 4                  | 8.00     | 7.00 | 6.00 | 5.00 | 4.50 | 3.50 | 2.50 |
| 6                  | 7.00     | 6.50 | 5.50 | 4.50 | 4.00 | 3.00 | 2.50 |
| 9                  | 6.00     | 5.50 | 4.50 | 4.00 | 3.50 | 3.00 | 2.00 |
| 12                 | 6.00     | 5.50 | 4.50 | 3.50 | 3.00 | 2.50 | 2.00 |
| 15                 | 5.50     | 5.00 | 4.00 | 3.50 | 3.00 | 2.50 | 2.00 |

Values are based on initial Temperature Rise versus Current Testing and are intended to be a guide in the selection of a connector family. All applications should be tested by the end user. The values listed are per circuit, for fully loaded housings being 100% energized. **Note:** All combinations above were not tested and this chart contains interpolated and extrapolated values.

**Minimum Wire Lengths for T-Rise vs. Current Testing**

| AWG | Min. Length (in.) | AWG | Min. Length (in.) |
|-----|-------------------|-----|-------------------|
| 30  | 2.6               | 18  | 9.4               |
| 28  | 3.2               | 16  | 11.3              |
| 26  | 4.1               | 14  | 13.7              |
| 24  | 5.1               | 12  | 16.4              |
| 20  | 7.8               | 10  | 19.3              |

**Note:** If wire lengths used are less than those listed above, the current-carrying ability of the system will be reduced due to less heat being conducted away from the connector. The customer should fully test all applications.

**Wire-to-Board**

Due to the vast differences in trace geometry and printed circuit board configurations, we are unable to provide a separate current carrying chart for our printed circuit board header products. However, the above Wire-to-Wire charts may be used as a guideline for headers if the trace width and thickness is equal to the listed wire gauge. For vertical headers, only 95% of the Wire-to-Wire value should be used. For right-angle headers, only 75% of the Wire-to-Wire value should be used. The chart values are only a tool for connector selection and will require the customer to fully test their application.

**Termination Resistance/Contact Crimp Tensile Force**

| Wire Size |                 | Termination Resistance |                                   | Contact Crimp Tensile Force |    |
|-----------|-----------------|------------------------|-----------------------------------|-----------------------------|----|
| AWG       | mm <sup>2</sup> | Test Current (Amps)    | Resistance Milliohms (Max. Init.) | Force (Min.)                |    |
|           |                 |                        |                                   | lbs.                        | N  |
| 30        | .05             | —                      | —                                 | —                           | —  |
| 28        | .08             | —                      | —                                 | —                           | —  |
| 26        | .12             | —                      | —                                 | 4                           | 18 |
| 24        | .2              | —                      | —                                 | 7                           | 31 |
| 22        | .3              | —                      | —                                 | 11                          | 49 |
| 20        | .5              | —                      | —                                 | 13                          | 58 |
| 18        | .8              | —                      | —                                 | 15                          | 67 |
| 16        | 1.2             | —                      | —                                 | 18                          | 80 |

High Density

Mini-Universal MATE-N-LOK Connectors  
.163 [4,14] Centerline

**Mini-Universal MATE-N-LOK Connectors (Continued)**

**Mini-Universal MATE-N-LOK Connector Mating Combinations**

| Connector Part Number |                     |          |                                    |                                   | Mating Connector Part Number |                  |                              |            |                             |
|-----------------------|---------------------|----------|------------------------------------|-----------------------------------|------------------------------|------------------|------------------------------|------------|-----------------------------|
| Number of Circuits    | Flammability Rating | Style    | Plug <sup>1</sup> Housing Part No. | Cap <sup>1</sup> Housing Part No. | PC Board Pin Headers         |                  |                              |            | Right-Angle With Board Lock |
|                       |                     |          |                                    |                                   | Plating                      | With Drain Holes | Vertical Without Drain Holes | Blindmate  |                             |
| 1                     | UL94V-2             | In-Line  | 172335-1                           | 172327-14                         | —                            | —                | —                            | —          | —                           |
|                       | UL94V-0             | In-Line  | 172164-1                           | 172156-14                         | Tin <sup>6</sup>             | —                | —                            | —          | 1-794374-0                  |
|                       |                     |          |                                    |                                   | Duplex <sup>5</sup>          | —                | —                            | —          | 1-794374-1                  |
| 2                     | UL94V-2             | In-Line  | 172336-1                           | 172328-12                         | —                            | —                | —                            | —          | —                           |
|                       |                     |          | 172343-14                          | 172343-14                         | —                            | —                | —                            | —          | —                           |
|                       |                     |          | 172807-13                          | 172807-13                         | —                            | —                | —                            | —          | —                           |
|                       | UL94V-0             | In-Line  | 173956-13                          | 173956-13                         | —                            | —                | —                            | —          | —                           |
|                       |                     |          | 172165-1                           | 172157-12                         | Tin <sup>6</sup>             | 1-770166-0       | 1-770872-0                   | —          | 1-770966-0                  |
|                       |                     |          | 794894-17                          | 172233-14                         | Duplex <sup>5</sup>          | 1-770166-1       | 1-770872-1                   | —          | 1-770966-1                  |
| 3                     | UL94V-2             | In-Line  | 172808-13                          | 794896-12,7                       | Tin/Duplex                   | 1-770166-1       | 1-770872-1                   | —          | 1-770966-1                  |
|                       |                     |          | 172337-1                           | 172808-13                         | —                            | —                | —                            | —          | —                           |
|                       |                     |          | 173957-13                          | 173957-13                         | —                            | —                | —                            | —          | —                           |
|                       | UL94V-0             | In-Line  | 172166-1                           | 172158-12                         | Tin                          | 1-770170-0       | 1-770873-0                   | —          | 1-770967-0                  |
|                       |                     |          | 172809-13                          | 172234-14                         | Duplex <sup>5</sup>          | 1-770170-1       | 1-770873-1                   | —          | 1-770967-1                  |
|                       |                     |          | 172338-1                           | 172330-12                         | —                            | —                | —                            | —          | —                           |
| 4                     | UL94V-2             | Dual Row | 173958-13                          | 173958-13                         | —                            | —                | —                            | —          | —                           |
|                       |                     |          | 172167-1                           | 172159-12                         | Tin                          | 1-770174-0       | 1-770874-0                   | 1-794325-0 | 1-770968-0                  |
|                       |                     |          | 794805-17                          | 794939-12,7                       | Duplex <sup>5</sup>          | 1-770174-1       | 1-770874-1                   | 1-794325-1 | 1-770968-1                  |
|                       | UL94V-0             | Dual Row | 172339-1                           | 172331-12                         | Tin/Duplex                   | 1-770174-1       | 1-770874-1                   | —          | 1-770968-1                  |
|                       |                     |          | 172168-1                           | 172160-12                         | —                            | —                | —                            | —          | —                           |
|                       |                     |          | 794895-17                          | 794940-12,7                       | Tin                          | 1-770178-0       | 1-770875-0                   | 1-794326-0 | 1-770969-0                  |
| 6                     | UL94V-0             | Dual Row | 770579-1                           | —                                 | Duplex <sup>5</sup>          | 1-770178-1       | 1-770875-1                   | 1-794326-1 | 1-770969-1                  |
|                       |                     |          | 794821-17                          | 794941-12,7                       | Tin/Duplex                   | 1-770178-1       | 1-770875-1                   | —          | 1-770969-1                  |
|                       |                     |          | 172340-1                           | 172332-12                         | Tin                          | 1-794065-0       | 1-794073-0                   | 1-794327-0 | 1-770970-0                  |
|                       | UL94V-2             | Matrix   | 172169-1                           | 172161-12                         | Duplex <sup>5</sup>          | 1-794065-1       | 1-794073-1                   | 1-794327-1 | 1-770970-1                  |
|                       |                     |          | 770580-1                           | —                                 | Tin/Duplex                   | 1-794065-1       | 1-794073-1                   | —          | 1-770970-1                  |
|                       |                     |          | 794781-17                          | 794942-12,7                       | —                            | —                | —                            | —          | —                           |
| 8                     | UL94V-0             | Dual Row | 172341-1                           | 172333-12                         | Tin                          | 1-770182-0       | 1-770876-0                   | 1-794432-0 | —                           |
|                       |                     |          | 172170-1                           | 172162-12                         | Duplex <sup>5</sup>          | 1-770182-1       | 1-770876-1                   | 1-794432-1 | —                           |
|                       |                     |          | 770581-1                           | —                                 | Tin                          | 1-770743-0       | 1-770858-0                   | 1-794328-0 | 1-770971-0                  |
|                       | UL94V-2             | Matrix   | 770582-1                           | —                                 | Duplex <sup>5</sup>          | 1-770743-1       | 1-770858-1                   | 1-794328-1 | 1-770971-1                  |
|                       |                     |          | 794781-17                          | 794942-12,7                       | Tin/Duplex                   | 1-770743-1       | 1-770858-1                   | —          | 1-770971-1                  |
|                       |                     |          | 172342-1                           | 172334-12                         | —                            | —                | —                            | —          | —                           |
| 10                    | UL94V-0             | Dual Row | 172171-1                           | 172163-12                         | Tin                          | 1-770186-0       | 1-794040-0                   | 1-794329-0 | —                           |
|                       |                     |          | 770583-1                           | —                                 | Duplex <sup>5</sup>          | 1-770186-1       | 1-794040-1                   | 1-794329-1 | —                           |
|                       |                     |          | 794781-17                          | 794942-12,7                       | Tin                          | 1-794066-0       | 1-770621-0                   | —          | 1-770972-0                  |
|                       | UL94V-2             | Matrix   | 770584-1                           | —                                 | Duplex <sup>5</sup>          | 1-794066-1       | 1-770621-1                   | —          | 1-770972-1                  |
|                       |                     |          | 770585-1                           | —                                 | Tin                          | 1-794067-0       | 1-794074-0                   | —          | 1-770973-0                  |
|                       |                     |          | 770586-1                           | —                                 | Duplex <sup>5</sup>          | 1-794067-1       | 1-794074-1                   | —          | 1-770973-1                  |
| 12                    | UL94V-0             | Dual Row | 172342-1                           | 172334-12                         | —                            | —                | —                            | —          | —                           |
|                       |                     |          | 770587-1                           | —                                 | Tin                          | 1-770190-0       | 1-770859-0                   | 1-794330-0 | —                           |
|                       |                     |          | 794781-17                          | 794942-12,7                       | Duplex <sup>5</sup>          | 1-770190-1       | 1-770859-1                   | 1-794330-1 | —                           |
|                       | UL94V-2             | Matrix   | 172171-1                           | 172163-12                         | Tin                          | 1-794068-0       | 1-794075-0                   | —          | 1-770974-0                  |
|                       |                     |          | 770588-1                           | —                                 | Duplex <sup>5</sup>          | 1-794068-1       | 1-794075-1                   | —          | 1-770974-1                  |
|                       |                     |          | 770589-1                           | —                                 | Tin                          | 1-794069-0       | 1-794076-0                   | —          | 1-794105-0                  |
| 14                    | UL94V-0             | Dual Row | 770589-1                           | —                                 | Duplex <sup>5</sup>          | 1-794069-1       | 1-794076-1                   | —          | 1-794105-1                  |
|                       |                     |          | 770585-1                           | —                                 | Tin                          | 1-794070-0       | 1-794077-0                   | —          | 1-794106-0                  |
|                       |                     |          | 770586-1                           | —                                 | Duplex <sup>5</sup>          | 1-794070-1       | 1-794077-1                   | —          | 1-794106-1                  |
|                       | UL94V-2             | Matrix   | 770586-1                           | —                                 | Tin                          | 1-794071-0       | 1-794078-0                   | —          | 1-794107-0                  |
|                       |                     |          | 770587-1                           | —                                 | Duplex <sup>5</sup>          | 1-794071-1       | 1-794078-1                   | —          | 1-794107-1                  |
|                       |                     |          | 770588-1                           | —                                 | Tin                          | 1-794072-0       | 1-794079-0                   | —          | 1-794108-0                  |
| UL94V-0               | Dual Row            | 770587-1 | —                                  | Duplex <sup>5</sup>               | 1-794072-1                   | 1-794079-1       | —                            | 1-794108-1 |                             |

<sup>1</sup>Mini-Universal MATE-N-LOK plug and cap housings accept pin or socket contacts. Use the appropriate contacts in the plug housing as required by the mating connector. All **Plugs** are **free-hanging** and **Caps** are **free-hanging** or **panel mount**, unless otherwise noted.

<sup>2</sup>Panel mount only.  
<sup>3</sup>Hermaphroditic: Mates to itself.

<sup>4</sup>Free-hanging only.  
<sup>5</sup>Duplex Finish—Plated with .000030 [.000762] min. gold in mating area and matte tin on solder tail end over .000050 [.00127] min. nickel underplate on entire contact.  
<sup>6</sup>Tin Finish—Plated with .000150 [.00381] min. tin over .000050 [.00127] min. nickel underplate on entire contact.

<sup>7</sup>For Splash-Proof Sealing.

**Note: All part numbers are RoHS Compliant.**

High Density

Mini-Universal MATE-N-LOK Connectors  
.163 [4.14] Centerline

**Mini-Universal MATE-N-LOK Connectors (Continued)**

**Contacts**

Pin diameter .039 [0.99]

**Material**

Brass or Phosphor bronze  
Stock Thickness .008 [0.20]  
These contacts are to be used in Mini-Universal MATE-N-LOK Plug or Cap housings only.



**Related Product Data**

**Product Specifications**  
108-1542 Mini-Universal MATE-N-LOK Connectors  
108-1543 Mini-Universal MATE-N-LOK Headers

**Application Specification**  
114-16017 Mini-Universal MATE-N-LOK Connectors

**Performance Characteristics** — pages 83-84

**Housings** — pages 87-89

**Technical Documents** — pages 83 and 205-206

**Application Tooling** — pages 207-210

| Wire Size Range AWG [mm <sup>2</sup> ]      | Ins. Dia. Range  | Material and Finish             | Contact Part Numbers    |                       | HDM Applicator Part No. | Hand Tool Part No.    |                       |
|---|--|---------------------------------|-------------------------|-----------------------|-------------------------|-----------------------|-----------------------|
|   |  |                                 | Pin Strip Form          | Pin Loose Pieces      |                         |                       | Socket Strip Form     |
| 30-26<br>[.05-.12]                          | .035-.050<br>[.889-1.27]                               | Brass, Pre-tin                  | 770835-1                | 794059-1              | 770834-1                | 794058-1              | 567418-1 <sup>3</sup> |
|   |  | Phos. Brz., Pre-tin             | —                       | —                     | 770834-4                | —                     | 567418-2 <sup>3</sup> |
|   |  | Brass, Duplex <sup>1</sup>      | 1-770835-0              | 1-794059-0            | 1-770834-0              | 1-794058-0            | 567418-3 <sup>3</sup> |
| 26-22<br>[.12-.3]                           | .047-.069<br>[1.19-1.75]                               | Phos. Brz., Duplex <sup>1</sup> | —                       | —                     | 1-770834-1              | —                     | —                     |
|   |  | Brass, Pre-tin                  | 770901-1                | 770985-1              | 770902-1                | 770986-1              | 567066-3 <sup>4</sup> |
|   |  | Phos. Brz., Pre-tin             | —                       | —                     | 770902-4                | —                     | 567066-4 <sup>4</sup> |
| 22-18<br>[.3-.8]<br>or<br>22 x (2)<br>[.3]  | .059-.094<br>[1.50-2.39]<br>or<br>.067 x (2)<br>[3.38] | Brass, Duplex <sup>1</sup>      | 1-770901-0              | 1-770985-0            | 1-770902-0              | 1-770986-0            | 91529-1               |
|   |  | Phos. Brz., Duplex <sup>1</sup> | —                       | —                     | 1-770902-1              | —                     | 567066-5 <sup>4</sup> |
|   |  | Brass, Pre-tin                  | 770903-1                | 770987-1              | 770904-1                | 770988-1              | 567067-1 <sup>3</sup> |
| 20-16<br>[.5-1.2]<br>or<br>20 x (2)<br>[.5] | .079-.126<br>[2.01-3.20]<br>or<br>.075 x (2)<br>[1.91] | Phos. Brz., Pre-tin             | —                       | —                     | 770904-4                | —                     | 567067-2 <sup>3</sup> |
|   |  | Brass, Duplex <sup>1</sup>      | 1-770903-0              | 1-770987-0            | 1-770904-0              | 1-770988-0            | 567067-3 <sup>3</sup> |
|   |  | Phos. Brz., Duplex <sup>1</sup> | —                       | —                     | 1-770904-1              | —                     | —                     |
| 20-16<br>[.5-1.2]<br>or<br>20 x (2)<br>[.5] | .079-.126<br>[2.01-3.20]<br>or<br>.075 x (2)<br>[1.91] | Brass, Pre-tin                  | 794406-1 <sup>2</sup>   | 171638-1 <sup>2</sup> | 794407-1 <sup>2</sup>   | 171639-1 <sup>2</sup> | —                     |
|   |  | Phos. Brz., Pre-tin             | —                       | —                     | 794407-4 <sup>2</sup>   | —                     | 680582-2 <sup>3</sup> |
|   |  | Brass, Duplex <sup>1</sup>      | 1-794406-0 <sup>2</sup> | —                     | 1-794407-0 <sup>2</sup> | —                     | 680582-3 <sup>3</sup> |
|   |  | Phos. Brz., Duplex <sup>1</sup> | —                       | —                     | 1-794407-1 <sup>2</sup> | —                     | 91536-1               |

<sup>1</sup> Duplex Finish — Plated with .000030 [.000762] min. gold in mating area and .000100 [.00254] min. tin in crimping area over .000050 [.00127] min. nickel underplate on entire contact.  
<sup>2</sup> .671 [17.04] and .659 [16.74] dimensions are .689 [17.50] for indicated part numbers.  
<sup>3</sup> HDM Applicator part number ending in -1 is used on AMPOMATOR CLS Machine with T or G Terminators, -2 is used on AMP-O-LECTRIC Model K Machine, -3 is used on AMP-O-ELECTRIC Model G Machine. See pages 207-210 for further information.  
<sup>4</sup> HDM Applicator part number ending in -3 is used on AMPOMATOR CLS Machine with T or G Terminators, -4 is used on AMP-O-LECTRIC Model K Machine, -5 is used on AMP-O-LECTRIC Model G Machine. See pages 207-210 for further information.

**Note: All part numbers are RoHS Compliant.**

**Keying Plug**

**Material**

UL94V-0 Nylon, white color



**Part Number**  
174670-1

**Test Probe Contact**

**Material and Finish**

Phosphor bronze, nickel plated



**Part Number**  
172971-1

**Notes:**

1. The test probe is inserted into the housing in the same direction as indicated by the arrow shown to the right.
2. The test probe can be used in the Cap or Plug Housing.
3. Test probes are supplied unassembled.



**Contact Extraction Tool**  
No. 189727-1  
IS 408-4118



**Contact Insertion Tool**  
(For inserting contacts applied to small diameter wire)  
No. 91002-1  
IS 408-7347

Mini-Universal MATE-N-LOK Connectors .163 [4.14] Centerline High Density

**Mini-Universal MATE-N-LOK Connectors (Continued)**

**Housings**

**Free-Hanging or Panel Mount**

.163 [4.14] Centerline spacing

**Related Product Data**

**Product Specifications**

- 108-1542 Mini-Universal MATE-N-LOK Connectors
- 108-1543 Mini-Universal MATE-N-LOK Headers
- 108-5151 Mini-Universal MATE-N-LOK Connectors (UL94V-2)
- 108-5138 Mini-Universal MATE-N-LOK Connectors (UL94V-0)

**Performance Characteristics**— pages 83-84

**Contacts** — page 86

**Keying Plug** — page 86

**Test Probe Contact** — page 86

**Panel Cutout Recommendations**— page 89

**Technical Documents**— pages 83 and 205-206

**Mating Headers** — pages 90-92

**1 Circuit, Free-Hanging**

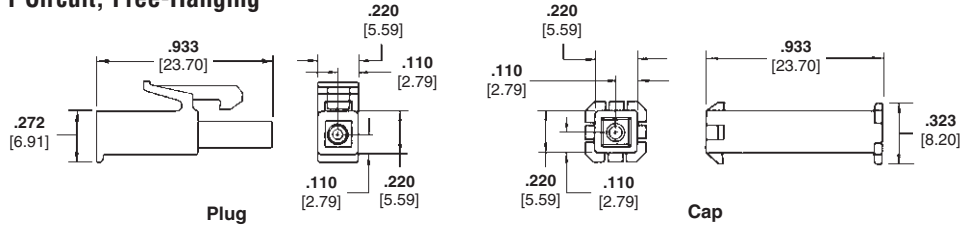

**2 and 3 Circuit, In-Line**

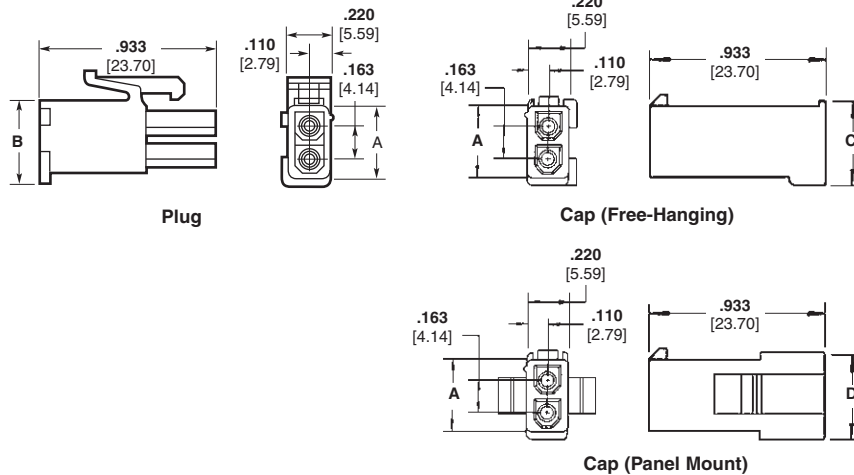

| Number of Circuits | Dimensions    |               |               |               | Housing Part Numbers <sup>1</sup> |                 |                  |                              |                 |                  |
|--------------------|---------------|---------------|---------------|---------------|-----------------------------------|-----------------|------------------|------------------------------|-----------------|------------------|
|                    |               |               |               |               | UL94V-0 Nylon, White Color        |                 |                  | UL94V-2 Nylon, Natural Color |                 |                  |
|                    | A             | B             | C             | D             | Plug                              | Cap Panel Mount | Cap Free-Hanging | Plug                         | Cap Panel Mount | Cap Free-Hanging |
| 1                  | —             | —             | —             | —             | 172164-1                          | —               | 172156-1         | 172335-1                     | —               | 172327-1         |
| 2                  | .386<br>9.80  | .425<br>10.79 | .488<br>12.39 | .464<br>11.78 | 172165-1                          | 172157-1        | 172233-1         | 172336-1                     | 172328-1        | 172343-1         |
| 3                  | .551<br>14.00 | .591<br>15.01 | .654<br>16.61 | .630<br>16.00 | 172166-1                          | 172158-1        | 172234-1         | 172337-1                     | 172329-1        | 172344-1         |

**Note:** All part numbers are RoHS Compliant.

**4 and 6 Circuit, Dual Row**



| Number of Circuits | A Dim.        | Housing Part Numbers <sup>1</sup> |          |                              |          |
|--------------------|---------------|-----------------------------------|----------|------------------------------|----------|
|                    |               | UL94V-0 Nylon, White Color        |          | UL94V-2 Nylon, Natural Color |          |
|                    |               | Plug                              | Cap      | Plug                         | Cap      |
| 4                  | .386<br>9.80  | 172167-1                          | 172159-1 | 172338-1                     | 172330-1 |
| 6                  | .551<br>14.00 | 172168-1                          | 172160-1 | 172339-1                     | 172331-1 |

<sup>1</sup>Housing part numbers shown in both charts (above) are also available in other colors: Red, Green, Blue, Black. To order connectors in these colors use the appropriate dash numbers as follows: Red 1-XXXXXX-2, Green 1-XXXXXX-5, Blue 1-XXXXXX-6, Black 1-XXXXXX-9

**Note:** All part numbers are RoHS Compliant.

**Mini-Universal MATE-N-LOK Connectors (Continued)**

**Housings**

.163 [4.14] Centerline spacing

**Related Product Data**

- Product Specifications**  
 108-1542 Mini-Universal MATE-N-LOK Connectors  
 108-1543 Mini-Universal MATE-N-LOK Headers  
 108-5151 Mini-Universal MATE-N-LOK Connectors (UL94V-2)  
 108-5138 Mini-Universal MATE-N-LOK Connectors (UL94V-0)

**Performance Characteristics**—  
pages 83-84

**Contacts** — page 86

**Keying Plug** — page 86

**Test Probe Contact** — page 86

**Panel Cutout Recommendations**—  
page 89

**Technical Documents**— pages 83  
and 205-206

**Mating Headers** — pages 90-92

**9, 12 and 15 Circuit,  
Free-Hanging or Panel Mount, Matrix**



| Number of Circuits | A Dim.        | Housing Part Numbers <sup>1</sup> |          |                              |          |
|--------------------|---------------|-----------------------------------|----------|------------------------------|----------|
|                    |               | UL94V-0 Nylon, White Color        |          | UL94V-2 Nylon, Natural Color |          |
|                    |               | Plug                              | Cap      | Plug                         | Cap      |
| 9                  | .551<br>13.99 | 172169-1                          | 172161-1 | 172340-1                     | 172332-1 |
| 12                 | .716<br>18.19 | 172170-1                          | 172162-1 | 172341-1                     | 172333-1 |
| 15                 | .882<br>22.40 | 172171-1                          | 172163-1 | 172342-1                     | 172334-1 |

<sup>1</sup>Housing part numbers shown in chart are also available in other colors: Red, Green, Blue, Black. To order connectors in these colors use the appropriate dash numbers as follows: Red 1-XXXXXX-2, Green 1-XXXXXX-5, Blue 1-XXXXXX-6, Black 1-XXXXXX-9

**Note:** All part numbers are RoHS Compliant.

**8 thru 24 Circuit,  
Free-Hanging, Dual Row**



| Number of Circuits | A Dim.      | Part Number<br>UL94V-0 Nylon, White Color<br>Plug |
|--------------------|-------------|---|
| 8                  | .714 18.14  | 770579-1  |
| 10                 | .877 22.28  | 770580-1  |
| 12                 | 1.040 26.42 | 770581-1  |
| 14                 | 1.203 30.56 | 770582-1  |
| 16                 | 1.366 34.70 | 770583-1  |
| 18                 | 1.529 38.84 | 770584-1  |
| 20                 | 1.692 42.98 | 770585-1  |
| 22                 | 1.855 47.12 | 770586-1  |
| 24                 | 2.018 51.26 | 770587-1  |

**Note:** All part numbers are RoHS Compliant.

Mini-Universal MATE-N-LOK Connectors .163 [4.14] Centerline

High Density



**Mini-Universal MATE-N-LOK Connectors (Continued)**

**Housings**  
**Hermaphroditic**  
**Free-Hanging**

**2, 3 and 4 Circuit**

**Related Product Data**

- Product Specifications**  
108-1542 Mini-Universal MATE-N-LOK Connectors  
108-1543 Mini-Universal MATE-N-LOK Headers  
108-5151 Mini-Universal MATE-N-LOK Connectors (UL94V-2)  
108-5138 Mini-Universal MATE-N-LOK Connectors (UL94V-0)

**Performance Characteristics**—  
pages 83-84

**Contacts** — page 86

**Cap Housings** — pages 87-89

**Technical Documents**— pages 83 and 205-206



| Number of Circuits | Part Numbers                 |                            |
|--------------------|------------------------------|----------------------------|
|                    | UL94V-2 Nylon, Natural Color | UL94V-0 Nylon, White Color |
| 2                  | 172807-1                     | 173956-1                   |
| 3                  | 172808-1                     | 173957-1                   |
| 4                  | 172809-1                     | 173958-1                   |

**Note:** Housing mates to itself; 2 required per wire-to-wire connection.

**Note:** All part numbers are RoHS Compliant.

**Recommended Cap Housing Panel Cutouts**

View is from cap entry side

Recommended Panel Thickness .031—.079 [.79 – 2.01]



| Number of Circuits | Dimensions     |               |              |               |
|--------------------|----------------|---------------|--------------|---------------|
|                    | A              | B             | C            | D             |
| 2                  | .421<br>10.69  | .242<br>6.15  | .098<br>2.49 | .407<br>10.3  |
| 3                  | .421<br>10.69  | .242<br>6.15  | .181<br>4.60 | .573<br>14.55 |
| 4                  | .587<br>14.91  | .407<br>10.34 | .098<br>2.49 | .407<br>10.3  |
| 6                  | .752<br>19.10  | .573<br>14.55 | .098<br>2.49 | .407<br>10.3  |
| 9                  | .752<br>19.10  | .573<br>14.55 | .181<br>4.60 | .573<br>14.55 |
| 12                 | .917<br>23.29  | .738<br>18.75 | .181<br>4.60 | .573<br>14.55 |
| 15                 | 1.080<br>27.43 | .904<br>22.96 | .181<br>4.60 | .573<br>14.55 |

**Mini-Universal MATE-N-LOK Connectors (Continued)**

**Vertical PC Board  
Pin Headers**

.163 [4.14] Centerline spacing

**Material**

**Housing** — Nylon, white

**Flammability Rating** — UL94V-0

**Contacts** — Brass

Solder tail diameter .039 [1.00]

**Related Product Data**

**Product Specifications**

108-1542 Mini-Universal MATE-N-LOK Connectors

108-1543 Mini-Universal MATE-N-LOK Headers

108-5151 Mini-Universal MATE-N-LOK Connectors (UL94V-2)

108-5138 Mini-Universal MATE-N-LOK Connectors (UL94V-0)

**Performance Characteristics** — pages 83-84

**Recommended PC Board Hole Layouts** — page 93

**Technical Documents** — pages 83 and 205-206

**Mating Connectors**

**Mini-Universal MATE-N-LOK**  
Plug Housings — pages 87-89

**Mini-Universal MATE-N-LOK 2**  
Plug Housings — pages 101-102

**2 and 3 Circuit, In-Line**

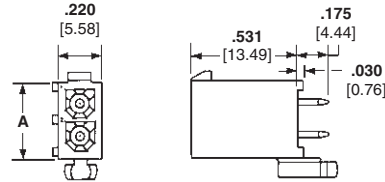

**4, 6, 8, 10 and 12 Circuit, Dual Row**



**9, 12 and 15 Circuit, Matrix**



**14, 16, 18, 20, 22 and 24 Circuit, Dual Row**



| Number of Circuits | Style    | A Dim.         | Pin Finish          | Vertical Pin Header Part Numbers |                     | Mates with Plug Housing Part Number (Using Socket Contact) |                             |
|--------------------|----------|----------------|---------------------|----------------------------------|---------------------|--|-----------------------------|
|                    |          |                |                     | With Drain Holes                 | Without Drain Holes | Mini-Universal MATE-N-LOK                                  | Mini-Universal MATE-N-LOK 2 |
| 2                  | In-Line  | .387<br>9.83   | Tin <sup>1</sup>    | 1-770166-0                       | 1-770872-0          | 172165-1   | 794184-1                    |
|                    |          |                | Duplex <sup>2</sup> | 1-770166-1                       | 1-770872-1          |  |                             |
| 3                  | In-Line  | .550<br>13.97  | Tin <sup>1</sup>    | 1-770170-0                       | 1-770873-0          | 172166-1   | 794186-1                    |
|                    |          |                | Duplex <sup>2</sup> | 1-770170-1                       | 1-770873-1          |  |                             |
| 4                  | Dual Row | .387<br>9.83   | Tin <sup>1</sup>    | 1-770174-0                       | 1-770874-0          | 172167-1   | 794188-1                    |
|                    |          |                | Duplex <sup>2</sup> | 1-770174-1                       | 1-770874-1          |  |                             |
| 6                  | Dual Row | .550<br>13.97  | Tin <sup>1</sup>    | 1-770178-0                       | 1-770875-0          | 172168-1   | 794190-1                    |
|                    |          |                | Duplex <sup>2</sup> | 1-770178-1                       | 1-770875-1          |  |                             |
| 8                  | Dual Row | .713<br>18.11  | Tin <sup>1</sup>    | 1-794065-0                       | 1-794073-0          | 770579-1   | 794192-1                    |
|                    |          |                | Duplex <sup>2</sup> | 1-794065-1                       | 1-794073-1          |  |                             |
| 9                  | Matrix   | .551<br>14.00  | Tin <sup>1</sup>    | 1-770182-0                       | 1-770876-0          | 172169-1   | 794194-1                    |
|                    |          |                | Duplex <sup>2</sup> | 1-770182-1                       | 1-770876-1          |  |                             |
| 10                 | Dual Row | .877<br>22.28  | Tin <sup>1</sup>    | 1-770743-0                       | 1-770858-0          | 770580-1   | 794196-1                    |
|                    |          |                | Duplex <sup>2</sup> | 1-770743-1                       | 1-770858-1          |  |                             |
| 12                 | Dual Row | 1.039<br>26.39 | Tin <sup>1</sup>    | 1-794066-0                       | 1-770621-0          | 770581-1   | 794198-1                    |
|                    |          |                | Duplex <sup>2</sup> | 1-794066-1                       | 1-770621-1          |  |                             |
| 12                 | Matrix   | .713<br>18.11  | Tin <sup>1</sup>    | 1-770186-0                       | 1-794040-0          | 172170-1   | 794200-1                    |
|                    |          |                | Duplex <sup>2</sup> | 1-770186-1                       | 1-794040-1          |  |                             |
| 14                 | Dual Row | 1.202<br>30.53 | Tin <sup>1</sup>    | 1-794067-0                       | 1-794074-0          | 770582-1   | 794202-1                    |
|                    |          |                | Duplex <sup>2</sup> | 1-794067-1                       | 1-794074-1          |  |                             |
| 15                 | Matrix   | .877<br>22.28  | Tin <sup>1</sup>    | 1-770190-0                       | 1-770859-0          | 172171-1   | 794204-1                    |
|                    |          |                | Duplex <sup>2</sup> | 1-770190-1                       | 1-770859-1          |  |                             |
| 16                 | Dual Row | 1.365<br>34.67 | Tin <sup>1</sup>    | 1-794068-0                       | 1-794075-0          | 770583-1   | 794206-1                    |
|                    |          |                | Duplex <sup>2</sup> | 1-794068-1                       | 1-794075-1          |  |                             |
| 18                 | Dual Row | 1.528<br>38.81 | Tin <sup>1</sup>    | 1-794069-0                       | 1-794076-0          | 770584-1   | 794208-1                    |
|                    |          |                | Duplex <sup>2</sup> | 1-794069-1                       | 1-794076-1          |  |                             |
| 20                 | Dual Row | 1.691<br>42.95 | Tin <sup>1</sup>    | 1-794070-0                       | 1-794077-0          | 770585-1   | 794210-1                    |
|                    |          |                | Duplex <sup>2</sup> | 1-794070-1                       | 1-794077-1          |  |                             |
| 22                 | Dual Row | 1.854<br>47.09 | Tin <sup>1</sup>    | 1-794071-0                       | 1-794078-0          | 770586-1   | 794212-1                    |
|                    |          |                | Duplex <sup>2</sup> | 1-794071-1                       | 1-794078-1          |  |                             |
| 24                 | Dual Row | 2.017<br>51.23 | Tin <sup>1</sup>    | 1-794072-0                       | 1-794079-0          | 770587-1   | 794214-1                    |
|                    |          |                | Duplex <sup>2</sup> | 1-794072-1                       | 1-794079-1          |  |                             |

<sup>1</sup> Tin Finish—Plated with .000150 [.00381] min. tin over .000050 [.00127] min. nickel underplate on entire contact.

<sup>2</sup> Duplex Finish—Plated with .000030 [.000762] min. gold in mating area and matte tin on solder tail end over .000050 [.00127] min. nickel underplate on entire contact.

**Note:** All part numbers are RoHS Compliant.

High Density

Mini-Universal MATE-N-LOK Connectors  
.163 [4.14] Centerline

**Mini-Universal MATE-N-LOK Connectors (Continued)**

**Vertical PC Board  
Blindmate Pin Headers**

.163 [4.14] Centerline spacing

**Material**

**Housing** — Nylon, white

**Flammability Rating** — UL94V-0

**Contacts** — Brass

Solder tail diameter .039 [1.00]

**Related Product Data**

**Product Specifications**

108-1693 Mini-Universal MATE-N-LOK 2 Connectors

108-1694 Mini-Universal MATE-N-LOK 2 Headers

**Performance Characteristics** — pages 83-84

**Recommended PC Board Hole Layouts** — page 93

**Technical Documents** — pages 83 and 205-206

**Mating Connectors**

**Mini-Universal MATE-N-LOK**

Plug Housings — pages 87-89

**Mini-Universal MATE-N-LOK 2**

Plug Housings — pages 101-102

**4, 6, 8 and 10 Circuit,  
Dual Row**

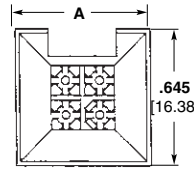

**9, 12 and 15 Circuit,  
Matrix**

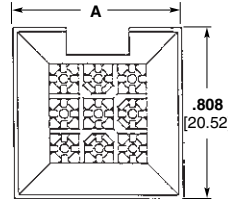

| Number of Circuits | Style    | A Dim.         | Pin Finish          | Pin Header Part Numbers With Drain Holes | Mates with Plug Housing Part Number (Using Socket Contacts) |                             |
|--------------------|----------|----------------|---------------------|--|---|-----------------------------|
|                    |          |                |                     |  | Mini-Universal MATE-N-LOK                                   | Mini-Universal MATE-N-LOK 2 |
| 4                  | Dual Row | .645<br>16.38  | Tin <sup>1</sup>    | 1-794325-0                               | 172167-1  | 794188-1                    |
|                    |          |                | Duplex <sup>2</sup> | 1-794325-1                               |   |                             |
| 6                  | Dual Row | .808<br>20.52  | Tin <sup>1</sup>    | 1-794326-0                               | 172168-1  | 794190-1                    |
|                    |          |                | Duplex <sup>2</sup> | 1-794326-1                               |   |                             |
| 8                  | Dual Row | .971<br>24.66  | Tin <sup>1</sup>    | 1-794327-0                               | 770579-1  | 794192-1                    |
|                    |          |                | Duplex <sup>2</sup> | 1-794327-1                               |   |                             |
| 9                  | Matrix   | .808<br>20.52  | Tin <sup>1</sup>    | 1-794432-0                               | 172169-1  | 794194-1                    |
|                    |          |                | Duplex <sup>2</sup> | 1-794432-1                               |   |                             |
| 10                 | Dual Row | 1.134<br>28.80 | Tin <sup>1</sup>    | 1-794328-0                               | 770580-1  | 794196-1                    |
|                    |          |                | Duplex <sup>2</sup> | 1-794328-1                               |   |                             |
| 12                 | Matrix   | .971<br>24.66  | Tin <sup>1</sup>    | 1-794329-0                               | 172170-1  | 794200-1                    |
|                    |          |                | Duplex <sup>2</sup> | 1-794329-1                               |   |                             |
| 15                 | Matrix   | 1.134<br>28.80 | Tin <sup>1</sup>    | 1-794330-0                               | 172171-1  | 794204-1                    |
|                    |          |                | Duplex <sup>2</sup> | 1-794330-1                               |   |                             |

<sup>1</sup> Tin Finish — Plated with .000150 [.00381] min. tin over .000050 [.00127] min. nickel underplate on entire contact.

<sup>2</sup> Duplex Finish — Plated with .000030 [.000762] min. gold in mating area and matte tin on solder tail end over .000050 [.00127] min. nickel underplate on entire contact.

**Note: All part numbers are RoHS Compliant.**

High Density

Mini-Universal MATE-N-LOK Connectors  
.163 [4.14] Centerline

**Mini-Universal MATE-N-LOK Connectors (Continued)**

**Right-Angle PC Board  
Pin Headers**

.163 [4.14] Centerline spacing

**Material**

**Housing**— Nylon, white color

**Flammability Rating**— UL94V-0

**Contacts**— Brass

Solder tail diameter .039 [1.00]

**Related Product Data**

**Product Specification**

108-1694 Mini-Universal  
MATE-N-LOK 2 Headers

**Performance Characteristics**—  
pages 83-84

**Recommended PC Board Hole  
Layouts**—page 93

**Technical Documents**— pages 83  
and 205-206

**Mating Connectors**

**Mini-Universal MATE-N-LOK**

Plug Housings—pages 87-89

**Mini-Universal MATE-N-LOK 2**

Plug Housings—pages 101-102

**With Board Lock Feature**

**1, 2 and 3 Circuit, In-Line**



**4, 6, 8, 10 and 12 Circuit, Dual Row**



**14, 16, 18, 20, 22 and 24 Circuit, Dual Row**

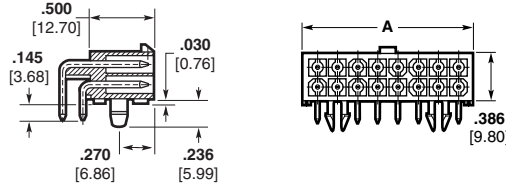

| Number of Circuits | Style    | A Dim.         | Pin Finish          | Pin Header Part Number With Board Lock | Mates with Plug Housing Part Number (Using Socket Contacts) |                             |
|--------------------|----------|----------------|---------------------|--|---|-----------------------------|
|                    |          |                |                     |  | Mini-Universal MATE-N-LOK                                   | Mini-Universal MATE-N-LOK 2 |
| 1                  | —        | .225<br>5.72   | Tin <sup>1</sup>    | 1-794374-0                             | 172164-1  | —                           |
|                    |          |                | Duplex <sup>2</sup> | 1-794374-1                             |   |                             |
| 2                  | In-Line  | .388<br>9.86   | Tin <sup>1</sup>    | 1-770966-0                             | 172165-1  | 794184-1                    |
|                    |          |                | Duplex <sup>2</sup> | 1-770966-1                             |   |                             |
| 3                  | In-Line  | .551<br>14.00  | Tin <sup>1</sup>    | 1-770967-0                             | 172166-1  | 794186-1                    |
|                    |          |                | Duplex <sup>2</sup> | 1-770967-1                             |   |                             |
| 4                  | Dual Row | .388<br>9.86   | Tin <sup>1</sup>    | 1-770968-0                             | 172167-1  | 794188-1                    |
|                    |          |                | Duplex <sup>2</sup> | 1-770968-1                             |   |                             |
| 6                  | Dual Row | .551<br>14.00  | Tin <sup>1</sup>    | 1-770969-0                             | 172168-1  | 794190-1                    |
|                    |          |                | Duplex <sup>2</sup> | 1-770969-1                             |   |                             |
| 8                  | Dual Row | .714<br>18.14  | Tin <sup>1</sup>    | 1-770970-0                             | 770579-1  | 794192-1                    |
|                    |          |                | Duplex <sup>2</sup> | 1-770970-1                             |   |                             |
| 10                 | Dual Row | .877<br>22.28  | Tin <sup>1</sup>    | 1-770971-0                             | 770580-1  | 794196-1                    |
|                    |          |                | Duplex <sup>2</sup> | 1-770971-1                             |   |                             |
| 12                 | Dual Row | 1.040<br>26.42 | Tin <sup>1</sup>    | 1-770972-0                             | 770581-1  | 794198-1                    |
|                    |          |                | Duplex <sup>2</sup> | 1-770972-1                             |   |                             |
| 14                 | Dual Row | 1.203<br>30.56 | Tin <sup>1</sup>    | 1-770973-0                             | 770582-1  | 794202-1                    |
|                    |          |                | Duplex <sup>2</sup> | 1-770973-1                             |   |                             |
| 16                 | Dual Row | 1.366<br>34.70 | Tin <sup>1</sup>    | 1-770974-0                             | 770583-1  | 794206-1                    |
|                    |          |                | Duplex <sup>2</sup> | 1-770974-1                             |   |                             |
| 18                 | Dual Row | 1.529<br>38.84 | Tin <sup>1</sup>    | 1-794105-0                             | 770584-1  | 794208-1                    |
|                    |          |                | Duplex <sup>2</sup> | 1-794105-1                             |   |                             |
| 20                 | Dual Row | 1.692<br>42.98 | Tin <sup>1</sup>    | 1-794106-0                             | 770585-1  | 794210-1                    |
|                    |          |                | Duplex <sup>2</sup> | 1-794106-1                             |   |                             |
| 22                 | Dual Row | 1.855<br>47.12 | Tin <sup>1</sup>    | 1-794107-0                             | 770586-1  | 794212-1                    |
|                    |          |                | Duplex <sup>2</sup> | 1-794107-1                             |   |                             |
| 24                 | Dual Row | 2.018<br>51.26 | Tin <sup>1</sup>    | 1-794108-0                             | 770587-1  | 794214-1                    |
|                    |          |                | Duplex <sup>2</sup> | 1-794108-1                             |   |                             |

<sup>1</sup>Tin Finish—Plated with .000150 [.00381] min. tin over .000050 [.00127] min. nickel underplate on entire contact.

<sup>2</sup>Duplex Finish—Plated with .000030 [.000762] min. gold in mating area and matte tin on solder tail end over .000050 [.00127] min. nickel underplate on entire contact.

**Note:** All part numbers are RoHS Compliant.

High Density

Mini-Universal MATE-N-LOK Connectors  
.163 [4.14] Centerline

**Mini-Universal MATE-N-LOK Connectors (Continued)**

**Recommended PC Board Hole Layouts for Vertical and Blindmate Headers**

.062 [1.57] thick board, tolerances non-accumulative

**Related Product Data**

**Vertical Headers**—pages 90-91

**2 and 3 Circuit, In-Line**



**4, 6, 8, 10 and 12 Circuit, Dual Row**



**9, 12 and 15 Circuit, Matrix**



**14, 16, 18, 20, 22 and 24 Circuit, Dual Row**

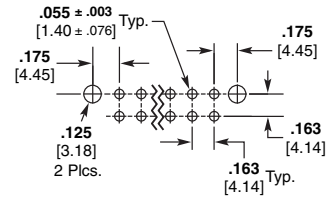

**Recommended PC Board Hole Layouts for Right-Angle Headers**

.062 [1.57] thick board, tolerances non-accumulative

**Related Product Data**

**Right-Angle Headers**—page 92

**1 Circuit**



**2 Circuit, In-Line**

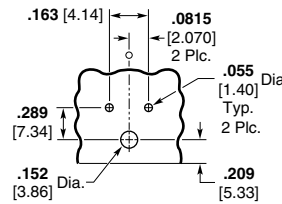

**3 Circuit, In-Line**



**4, 8 and 12 Circuit, Dual Row**



**6 and 10 Circuit, Dual Row**

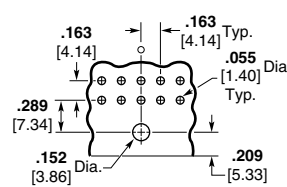

**14 and 18 Circuit, Dual Row**



**22 Circuit, Dual Row**



**16, 20 and 24 Circuit, Dual Row**

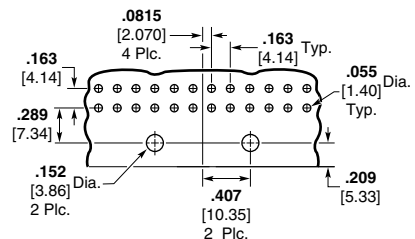

High Density

Mini-Universal MATE-N-LOK Connectors  
.163 [4.14] Centerline

**Mini-Universal MATE-N-LOK Connectors (Continued)**

**Strain Reliefs for Plug or Cap Housings**

**Related Product Data**

**Housings**—pages 87-89  
**Technical Documents**—pages 83 and 205-206

These Strain Reliefs may also be used with AMP-DUAC Receptacle housings on page 126.

**6 and 8 Circuit**



| Style    | Number of Circuits | A Dim.        | Wire Bundle Dia. Range | Part Numbers               |  |
|----------|--------------------|---------------|------------------------|----------------------------|--|
|          |                    |               |                        | UL94V-0 Nylon, White Color | Use With                                     |
| Dual Row | 6                  | .920<br>23.36 | .165-.220<br>4.19-5.59 | 794423-1                   | 172168-1<br>172160-1<br>172339-1<br>172331-1 |
|          | 8                  | .920<br>23.36 | .180-.245<br>4.57-6.22 | 794370-1                   | 770979-1                                     |

**9 Circuit**



| Style  | Number of Circuits | Part Numbers |                                  |
|--------|--------------------|--------------|----------------------------------|
|        |                    | Part Number  | Use With                         |
| Matrix | 9                  | <b>Plug</b>  | 316454-1<br>172169-1<br>172340-1 |
|        |                    | <b>Cap</b>   | 316455-1<br>172161-1<br>172332-1 |

**Note:** All part numbers are RoHS Compliant.

High Density  
Mini-Universal MATE-N-LOK Connectors  
.163 [4.14] Centerline

## Mini-Universal MATE-N-LOK Sealed Connector System

### Product Facts — Sealed Connector System

- Splash-proof design allows use in areas where high humidity, intermittent liquid splashing or foam-in applications require a sealed connector for improved electrical performance
- Wire-to-wire and wire-to-board
- Dual row, 2 to 10 positions (even only) and 16 positions
- Mates with all standard Mini-Universal MATE-N-LOK connector housings and pin headers (except Blindmate)
- Positive, polarized keyed and latched orientation to ease application
- Utilizes proven Mini-Universal MATE-N-LOK contacts with existing application tooling
- Tested to Sealing Level of IP56 and IP57 per IEC 60529
- Primarily used in Appliance, Vending and HVAC applications
- Compact, durable housings
- Pins and sockets can be accommodated in the same housings
- Contacts fully protected in the housings. Both pins and sockets can be used on the power supply wiring
- Fully polarized to provide proper plug-to-cap mating incorporating a positive locking mechanism to help prevent accidental disengagement of mated connectors. Also facilitates panel mounting
- Free-hanging or panel mount
- Connectors can be mounted to .031-.079 [0.79-2.00] thick panels
- With seals, contacts accept wire size range 26-18 AWG [.12-.8 mm<sup>2</sup>] with insulation diameter of .040-.083 [1.02-2.11]
- .163 [4.14] centerline spacing
- Not for interrupting current



### Performance Characteristics

The Mini-Universal MATE-N-LOK Connector performance characteristics found on pages 95-96 are based on free-hanging and panel mount connectors, loaded with contacts crimped on stranded wire.

#### Low Level Termination Resistance

20 milliohms max. total resistance between wire crimps of a mated pin and socket

#### Dielectric Withstanding Voltage—

1.5 KVAC between adjacent circuits

#### Insulation Resistance—

1000 megohms minimum between adjacent circuits

#### Voltage Rating—600 V AC or DC

**Contact Retention**—8 lb. min. per contact

**Durability**—20 cycles, mating and unmating

### Technical Documents

#### Product Specifications

- 108-1542-2 Mini-Universal MATE-N-LOK Splash-Proof Seals
- 108-1542 Mini-Universal MATE-N-LOK Connectors
- 108-1543 Mini-Universal MATE-N-LOK Headers

#### Application Specification

- 114-13089 Mini-Universal MATE-N-LOK Sealed Connector

#### Instruction Sheets

- 408-3234 Mini-Universal MATE-N-LOK Connectors
- 411-5105 Mini-Universal MATE-N-LOK Connectors

**Mini-Universal MATE-N-LOK Sealed Connector System (Continued)**

**Plug**

Part Number 794894-1  
(2 position shown)



**Cap**

Part Number 794896-1  
(2 position shown)

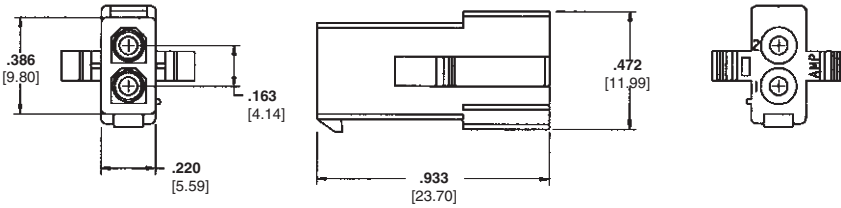

**Individual Wire Seals**

**Single Housing Cavity Plug Seal**

Part Number 794995-1



**Single Wire Seal**

Part Number 794758-1



**Interface Seals**



| Number of Positions | Interface Seals | Plug for Sealing | Cap for Sealing | Vertical Headers for Sealing | Right Angle Headers for Sealing |
|---------------------|-----------------|------------------|-----------------|------------------------------|---------------------------------|
| 2                   | 794772-2        | 794894-1         | 794896-1        | 1-770872-X                   | 1-770966-X                      |
| 4                   | 794772-4        | 794805-1         | 794939-1        | 1-770874-X                   | 1-770968-X                      |
| 6                   | 794772-6        | 794895-1         | 794940-1        | 1-770875-X                   | 10770969-X                      |
| 8                   | 794772-8        | 794821-1         | 794941-1        | 1-794073-X                   | 1-770970-X                      |
| 10                  | 1-794772-0      | 794781-1         | 794942-1        | 1-770858-X                   | 1-770971-X                      |
| 16                  | 1-1586362-6     | 794824-1         | —               | 1-794075-X                   | 1-770974-X                      |

-0 for tin finish, -1 for duplex. See Mini-Universal MATE-N-LOK section for details

**Individual Wire Seal Contacts**

| Wire Size Range AWG [mm <sup>2</sup> ] | Ins. Dia. Range        | Material and Finish                          | Contact Part Numbers (for use with Single Wire Seals) |             |            |             | HDM Applicator Part No. | Hand Tool Part No. |
|--|------------------------|--|---|-------------|------------|-------------|-------------------------|--------------------|
|  |                        |  | Pin   |             | Socket     |             |                         |                    |
|  |                        |  | Strip Form  | Loose Piece | Strip Form | Loose Piece |                         |                    |
| 26-22<br>[.12-.3]                      | .040-.060<br>1.02-1.52 | Brass, Pre-tin<br>Brass, Duplex <sup>1</sup> | 770901-1  | 770985-1    | 770902-1   | 770986-1    | 567066-3 <sup>3</sup>   | 91529-1            |
|  |                        |  | 1-770901-0  | 1-770985-0  | 1-770902-0 | 1-770986-0  | 567066-4 <sup>3</sup>   |                    |
|  |                        |  |   |             |            |             | 567066-5 <sup>3</sup>   |                    |
| 22-18<br>[.3-.8]                       | .050-.083<br>1.27-2.11 | Brass, Pre-tin<br>Brass, Duplex <sup>1</sup> | 770903-1  | 770987-1    | 770904-1   | 770988-1    | 567067-1 <sup>2</sup>   | 91522-1            |
|  |                        |  | 1-770903-0  | 1-770987-0  | 1-770904-0 | 1-770988-0  | 567067-2 <sup>2</sup>   |                    |
|  |                        |  |   |             |            |             | 567067-3 <sup>2</sup>   |                    |

<sup>1</sup> Duplex Finish — Plated with .000030 [.000762] min. gold in mating area and .000100 [.00254] min. tin in crimping area over .000050 [.00127] min. nickel underplate on entire contact.

<sup>2</sup> HDM Applicator part number ending in -1 is used on AMPOMATOR CLS Machine with T or G Terminators, -2 is used on AMP-O-LECTRIC Model K Machine, -3 is used on AMP-O-ELECTRIC Model G Machine. See pages 207-210 for further information.

<sup>3</sup> HDM Applicator part number ending in -3 is used on AMPOMATOR CLS Machine with T or G Terminators, -4 is used on AMP-O-LECTRIC Model K Machine, -5 is used on AMP-O-LECTRIC Model G Machine. See pages 207-210 for further information.

**Note: Ganged Wire Seals are available; contact Technical Support.**

Mini-Universal MATE-N-LOK Sealed Connector System  
.163 [4.14] Centerline  
High Density



**Mini-Universal MATE-N-LOK Connectors (Continued)**

**New: Mini Universal Gang Seals No Seal Crimping Required!**



| Number of Positions | Interface Seals | Gang Wire Seal | Plug for Sealing | Cap for Sealing | Vertical Headers for Sealing* | Right Angle Headers for Sealing* |
|---------------------|-----------------|----------------|------------------|-----------------|-------------------------------|----------------------------------|
| 2                   | 794772-2        | 1586359-2      | 794894-1         | 794896-1        | 1-770872-X                    | 1-770966-X                       |
| 4                   | 794772-4        | 1586359-4      | 794805-1         | 794939-1        | 1-770874-X                    | 1-770968-X                       |
| 6                   | 794772-6        | 1586359-6      | 794895-1         | 794940-1        | 1-770875-X                    | 1-770969-X                       |
| 8                   | 794772-8        | 1586359-8      | 794821-1         | 794941-1        | 1-794073-X                    | 1-770970-X                       |
| 10                  | 1-794772-0      | 1-1586359-0    | 794781-1         | 794942-1        | 1-770858-X                    | 1-770971-X                       |
| 16                  | 1-1586362-6     | 1-1586359-6    | 794824-1         | —               | 1-794075-X                    | 1-770974-X                       |

\*0 for tin finish, -1 for duplex. See Mini-Universal MATE-N-LOK section for details

**Gang Wire Seal Contacts**

| Wire Size Range | Insulation Range | Material Finish                              | Pin        |             | Socket     |             |
|-----------------|------------------|--|------------|-------------|------------|-------------|
|                 |                  |  | Strip Form | Loose Piece | Strip Form | Loose Piece |
| 16 AWG          | .050 - .083      | Brass, Pre-tin<br>Brass, Duplex <sup>1</sup> | 1586537-1  | —           | 1586538-1  | —           |
|                 |                  |  | 1586537-3  | —           | 1586538-3  | —           |
| 18 - 22 AWG     | .050 - .083      | Brass, Pre-tin<br>Brass, Duplex              | 794440-1   | —           | 794831-1   | —           |
|                 |                  |  | 794440-3   | —           | 794831-3   | —           |
| 22 - 26 AWG     | .050 - .069      | Brass, Pre-tin<br>Brass, Duplex <sup>1</sup> | 770901-1   | 770985-1    | 770902-1   | 770986-1    |
|                 |                  |  | 1-770901-0 | 1-770985-0  | 1-770902-0 | 1-770986-0  |

<sup>1</sup> Duplex Finish—Plated with .000030 [.000762] min. gold in mating area and .000100 [.00254] min. tin in crimping area over .000050 [.00127] min. nickel underplate on entire contact.

---

**Engineering Notes**

---



## Mini-Universal MATE-N-LOK 2 Connectors

### Product Facts

- One molded piece, secondary locking plug and cap housing assemblies
- Three-point stabilization to provide better terminal position
- Fully polarized to provide proper plug-to-cap mating
- Lanceless contacts for tangle-free handling
- Toolless contact removal
- Tin or duplex gold plated contacts
- Available in 2 through 24 circuit sizes wire-to-wire and wire-to-board
- Mates with standard Mini-Universal MATE-N-LOK headers and connectors
- Contacts available in strip and loose piece
- Polarized housings available in UL 94V-0 or UL 94V-2 flammability rated material
- Mini-Universal MATE-N-LOK 2 pins and sockets can be intermixed in Mini-Universal MATE-N-LOK 2 housings
- Mini-Universal MATE-N-LOK 2 pins and sockets can not be used in standard Mini-Universal MATE-N-LOK housings
- Contacts accept wire size range 30-16 AWG [.05-1.2 mm<sup>2</sup>]
- .163 [4.14] centerline spacing
- Not for interrupting current
- Recognized under the Component Program of Underwriters Laboratories Inc. to US and Canadian Standards, File No. E28476



### Performance Characteristics

The Mini-Universal MATE-N-LOK 2 Connector performance characteristics found on pages 99-100 are based on free-hanging connectors, loaded with contacts crimped on stranded wire.

#### Low Level Termination Resistance

20 milliohms max. total resistance between wire crimps of a mated pin and socket

#### Dielectric Withstanding Voltage

1500 V AC or DC between adjacent circuits at sea level

#### Insulation Resistance—

100 megohms minimum between adjacent circuits

#### Voltage Rating—600 V AC or DC

**Contact Retention**—15 lb. min. per contact

**Durability**—25 cycles, mating and unmating

**Current Rating**—up to 10.5 amps per circuit; 2 position

**Mating Force**—2.5 lb. max. per circuit

**Unmating Force**—0.25 lb. minimum per circuit

| Wire Size |                 | Termination Resistance |                                   | Contact Crimp Tensile Force |    |
|-----------|-----------------|------------------------|-----------------------------------|-----------------------------|----|
| AWG       | mm <sup>2</sup> | Test Current (Amps)    | Resistance Milliohms (Max. Init.) | Force (Min.) lbs.           | N  |
| 30        | .05             | —                      | —                                 | —                           | —  |
| 28        | .08             | —                      | —                                 | —                           | —  |
| 26        | .12             | —                      | —                                 | 4                           | 18 |
| 24        | .2              | —                      | —                                 | —                           | —  |
| 22        | .3              | —                      | —                                 | 11                          | 49 |
| 20        | .5              | —                      | —                                 | 13                          | 58 |
| 18        | .8              | —                      | —                                 | 15                          | 67 |
| 16        | 1.2             | —                      | —                                 | 18                          | 80 |

### Technical Documents

#### Product Specifications

108-1693 Mini-Universal MATE-N-LOK 2 Connectors

108-1694 Mini-Universal MATE-N-LOK 2 Headers

#### Application Specification

114-1111 Mini-Universal MATE-N-LOK 2 Connectors

#### Instruction Sheet

408-3393 Mini-Universal MATE-N-LOK 2 Connectors

Mini-Universal MATE-N-LOK 2 connectors also will withstand the following tests:

**Housing Lock Strength**—6 lb. min.

**Thermal Shock**—-55°C to +105°C

**Temperature-Humidity Cycling**—25°C to 65°C at 95 RH

**Vibration**—10-55-10 cycles per minute at .06 inch total excursion

**Physical Shock**—18 drops, 50 G half-sine at 11 milliseconds

**Mini-Universal MATE-N-LOK 2 Connectors (Continued)**

**Performance Characteristics (Continued)**

**Maximum Current**—Maximum current rating of Mini-Universal MATE-N-LOK 2 connectors is limited by the maximum operating temperature of the housings which is 105°C (gold) or 85°C (tin) including the temperature rise of the contacts which is a maximum of 30°C. There are several variables which have a direct effect on this maximum current-carrying capability for a given connector and must be considered for each application. These variables are:

**Wire Size**—Larger diameter wire will carry more current since it has less internal resistance to current flow and thus generates less heat. Longer wire lengths also enhance current-carrying capabilities since the wire conducts heat away from the connector.

**Connector Size**—In general, the more circuits in a connector, the less current can be carried.

**Ambient Temperature**—The higher the ambient temperature, the less current can be carried in any given connector.

**Printed Wiring Board Conductor Size**—The finished trace conductor width and thickness should be maximized to allow for the greatest current-carrying capacity and heat dissipation.

**Current Rating Verification for 30°C Maximum Temperature Rise 100% Energized**

**2 Circuit Connector (Wire-to-Wire)**

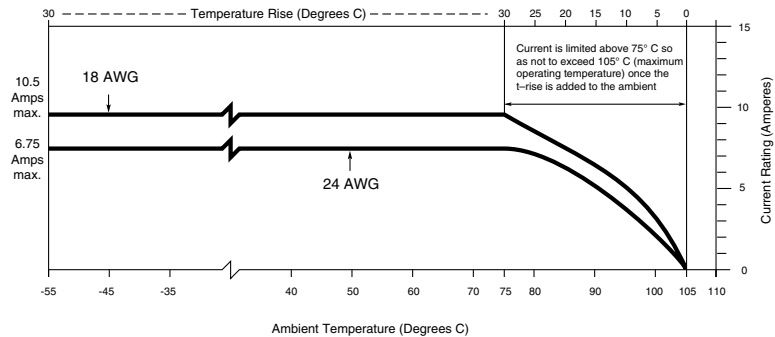

**6 Circuit Connector (Wire-to-Wire)**



**Contacts**

Pin diameter .039 [0.99]

**Material**

Brass

Stock Thickness .010 [0.25]

These contacts can be used in either Mini-Universal MATE-N-LOK 2 Plug or Cap housings **only**.



**Not to be used with Mini-Universal MATE-N-LOK Connectors**

**Related Product Data**

| Product Specifications                          | Wire Size Range AWG [mm <sup>2</sup> ] | Ins. Dia. Range     | Finish                      | Pin Strip Form      | Pin Loose Piece     | Socket Strip Form   | Socket Loose Piece  | HDM Applicator Part No.       | Hand Tool Part No. |
|---|--|---------------------|-----------------------------|---------------------|---------------------|---------------------|---------------------|-------------------------------|--------------------|
| 108-1693 Mini-Universal MATE-N-LOK 2 Connectors | 30-26 [0.5-1.2]                        | .035-.050 .889-1.27 | Pre-tin Duplex <sup>1</sup> | 794216-1 1-794216-0 | 794224-1 1-794224-0 | 794217-1 1-794217-0 | 794225-1 1-794225-0 | 567418-12 567418-22 567418-32 | 90717-2            |
| 108-1694 Mini-Universal MATE-N-LOK 2 Headers    | 26-22 [1.2-3]                          | .047-.069 1.19-1.75 | Pre-tin Duplex <sup>1</sup> | 794218-1 1-794218-0 | 794226-1 1-794226-0 | 794219-1 1-794219-0 | 794227-1 1-794227-0 | 567066-33 567066-43 567066-53 | 91529-1            |
|   | 22-18 [.3-.8]                          | .059-.094 1.50-2.39 | Pre-tin Duplex <sup>1</sup> | 794220-1 1-794220-0 | 794228-1 1-794228-0 | 794221-1 1-794221-0 | 794229-1 1-794229-0 | 680854-12 680854-22 680854-32 | 91522-1            |
|   | 20-16 [1.5-1.2]                        | .079-.126 2.01-3.20 | Pre-tin Duplex <sup>1</sup> | 794222-1 1-794222-0 | 794230-1 1-794230-0 | 794223-1 1-794223-0 | 794231-1 1-794231-0 | 680582-22 680582-32           | 91594-1            |

**Application Specification**

114-1111 Mini-Universal MATE-N-LOK 2 Connectors

**Performance Characteristics**— pages 99-100

**Housings**— pages 101-102

**Technical Documents**— pages 99 and 205-206

| Wire Size Range AWG [mm <sup>2</sup> ] | Ins. Dia. Range     | Finish                      | Contact Part Numbers |                     |                     |                     | HDM Applicator Part No.       | Hand Tool Part No. |
|--|---------------------|-----------------------------|----------------------|---------------------|---------------------|---------------------|-------------------------------|--------------------|
|  |                     |                             | Pin                  |                     | Socket              |                     |                               |                    |
| 30-26 [0.5-1.2]                        | .035-.050 .889-1.27 | Pre-tin Duplex <sup>1</sup> | 794216-1 1-794216-0  | 794224-1 1-794224-0 | 794217-1 1-794217-0 | 794225-1 1-794225-0 | 567418-12 567418-22 567418-32 | 90717-2            |
| 26-22 [1.2-3]                          | .047-.069 1.19-1.75 | Pre-tin Duplex <sup>1</sup> | 794218-1 1-794218-0  | 794226-1 1-794226-0 | 794219-1 1-794219-0 | 794227-1 1-794227-0 | 567066-33 567066-43 567066-53 | 91529-1            |
| 22-18 [.3-.8]                          | .059-.094 1.50-2.39 | Pre-tin Duplex <sup>1</sup> | 794220-1 1-794220-0  | 794228-1 1-794228-0 | 794221-1 1-794221-0 | 794229-1 1-794229-0 | 680854-12 680854-22 680854-32 | 91522-1            |
| 20-16 [1.5-1.2]                        | .079-.126 2.01-3.20 | Pre-tin Duplex <sup>1</sup> | 794222-1 1-794222-0  | 794230-1 1-794230-0 | 794223-1 1-794223-0 | 794231-1 1-794231-0 | 680582-22 680582-32           | 91594-1            |

<sup>1</sup>Duplex Finish — Plated with .000030 [.000762] min. gold in mating area and .000100 [.00254] min. tin in crimping area over .000050 [.00127] min. nickel underplate on entire contact.

<sup>2</sup>HDM Applicator part number ending in -1 is used on AMPOMATOR CLS Machine with T or G Terminators, -2 is used on AMP-O-LECTRIC Model K Machine, -3 is used on AMP-O-ELECTRIC Model G Machine.

<sup>3</sup>HDM Applicator part number ending in -3 is used on AMPOMATOR CLS Machine with T or G Terminators, -4 is used on AMP-O-LECTRIC Model K Machine, -5 is used on AMP-O-LECTRIC Model G Machine.

See pages 207-210 for further information.

**Note: All part numbers are RoHS Compliant.**

**Mini-Universal MATE-N-LOK 2 Connectors** (Continued)

**Housings**

**Free-Hanging**

.163 [4.14] Centerline spacing

**Related Product Data**

**Product Specifications**  
108-1693 Mini-Universal MATE-N-LOK 2 Connectors

108-1694 Mini-Universal MATE-N-LOK 2 Headers

**Performance Characteristics**—

pages 99-100

**Contacts** — page 100

**Technical Documents**— pages 99 and 205-206

**Mating Headers**—pages 103-105

**2 and 3 Circuit, In-Line**



| Number of Circuits | A Dimension   | Housing Part Numbers       |          |                              |          |
|--------------------|---------------|----------------------------|----------|------------------------------|----------|
|                    |               | UL94V-0 Nylon, White Color |          | UL94V-2 Nylon, Natural Color |          |
|                    |               | Plug                       | Cap      | Plug                         | Cap      |
| 2                  | .405<br>10.29 | 794184-1                   | 794185-1 | 794237-1                     | 794238-1 |
| 3                  | .405<br>10.29 | 794186-1                   | 794187-1 | 794239-1                     | 794240-1 |

**4 and 6 Circuit, Dual Row**



| Number of Circuits | A Dimension   | Housing Part Numbers       |          |                              |          |
|--------------------|---------------|----------------------------|----------|------------------------------|----------|
|                    |               | UL94V-0 Nylon, White Color |          | UL94V-2 Nylon, Natural Color |          |
|                    |               | Plug                       | Cap      | Plug                         | Cap      |
| 4                  | .571<br>14.50 | 794188-1                   | 794189-1 | 794241-1                     | 794242-1 |
| 6                  | .736<br>18.70 | 794190-1                   | 794191-1 | 794243-1                     | 794244-1 |

**Keying Plug**

**Material**

UL94V-0 Nylon, white color

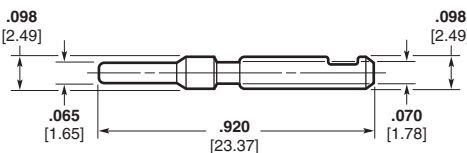

Part Number 794369-1

**Note:** All part numbers are RoHS Compliant.

**Mini-Universal MATE-N-LOK 2 Connectors** (Continued)

**Housings**  
**Free-Hanging**

.163 [4.14] Centerline spacing

**Related Product Data**

**Product Specifications**  
108-1693 Mini-Universal MATE-N-LOK 2 Connectors

108-1694 Mini-Universal MATE-N-LOK 2 Headers

**Performance Characteristics**—  
pages 99-100

**Contacts**—page 100

**Keying Plug**—page 101

**Technical Documents**—pages 99 and 205-206

**Mating Headers**—pages 103-105

**9, 12 and 15 Circuit, Matrix**



| Number of Circuits | A Dimension    | Housing Part Numbers       |          |                              |          |
|--------------------|----------------|----------------------------|----------|------------------------------|----------|
|                    |                | UL94V-0 Nylon, White Color |          | UL94V-2 Nylon, Natural Color |          |
|                    |                | Plug                       | Cap      | Plug                         | Cap      |
| 9                  | .736<br>18.69  | 794194-1                   | 794195-1 | 794247-1                     | 794248-1 |
| 12                 | .901<br>22.89  | 794200-1                   | 794201-1 | 794253-1                     | 794254-1 |
| 15                 | 1.067<br>27.10 | 794204-1                   | 794205-1 | 794257-1                     | 794258-1 |

**8 through 24 Circuit, Dual Row**



| Number of Circuits | A Dimension    | Housing Part Numbers       |          |                              |          |
|--------------------|----------------|----------------------------|----------|------------------------------|----------|
|                    |                | UL94V-0 Nylon, White Color |          | UL94V-2 Nylon, Natural Color |          |
|                    |                | Plug                       | Cap      | Plug                         | Cap      |
| 8                  | .899<br>22.84  | 794192-1                   | 794193-1 | 794245-1                     | 794246-1 |
| 10                 | 1.062<br>26.98 | 794196-1                   | 794197-1 | 794249-1                     | 794250-1 |
| 12                 | 1.225<br>31.12 | 794198-1                   | 794199-1 | 794251-1                     | 794252-1 |
| 14                 | 1.388<br>35.26 | 794202-1                   | 794203-1 | 794255-1                     | 794256-1 |
| 16                 | 1.551<br>39.40 | 794206-1                   | 794207-1 | 794259-1                     | 794260-1 |
| 18                 | 1.714<br>43.54 | 794208-1                   | 794209-1 | 794261-1                     | 794262-1 |
| 20                 | 1.877<br>47.68 | 794210-1                   | 794211-1 | 794263-1                     | 794264-1 |
| 22                 | 2.040<br>51.82 | 794212-1                   | 794213-1 | 794265-1                     | 794266-1 |
| 24                 | 2.203<br>55.96 | 794214-1                   | 794215-1 | 794267-1                     | 794268-1 |

**Note:** All part numbers are RoHS Compliant.

High Density

Mini-Universal MATE-N-LOK 2 Connectors  
.163 [4.14] Centerline

**Mini-Universal MATE-N-LOK 2 Connectors** (Continued)

**Vertical PC Board Pin Headers**

.163 [4.14] Centerline spacing

**Material**

**Housing**— Nylon, white

**Flammability Rating**—UL94V-0

**Contacts**— Brass

Solder tail diameter .039 [1.00]

**Related Product Data**

**Product Specifications**

108-1693 Mini-Universal MATE-N-LOK 2 Connectors

108-1694 Mini-Universal MATE-N-LOK 2 Headers

**Performance Characteristics**— pages 99-100

**Recommended PC Board Hole Layout**—page 106

**Technical Documents**— pages 99 and 205-206

**Mating Connectors**

**Mini-Universal MATE-N-LOK 2**

Plug Housings—pages 101-102

**Mini-Universal MATE-N-LOK**

Plug Housings—pages 87-89

**2 and 3 Circuit, In-Line**

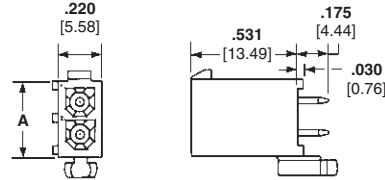

**4, 6, 8, 10 and 12 Circuit, Dual Row**



**9, 12 and 15 Circuit, Matrix**

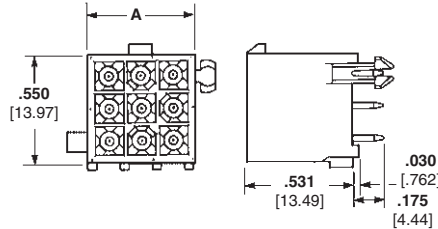

**14, 16, 18, 20, 22 and 24 Circuit, Dual Row**

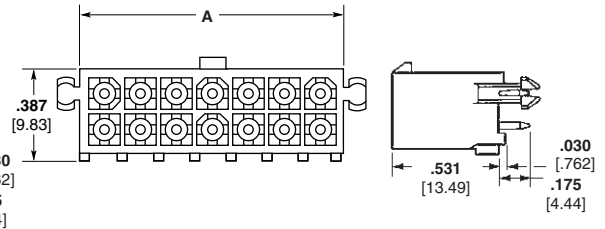

| Number of Circuits | Style    | A Dim.         | Pin Finish          | Vertical Pin Header Part Numbers |                     | Mates with Plug Housing Part Number (Using Socket Contacts) |                             |
|--------------------|----------|----------------|---------------------|----------------------------------|---------------------|---|-----------------------------|
|                    |          |                |                     | With Drain Holes                 | Without Drain Holes | Mini-Universal MATE-N-LOK                                   | Mini-Universal MATE-N-LOK 2 |
| 2                  | In-Line  | .387<br>9.83   | Tin <sup>1</sup>    | 1-770166-0                       | 1-770872-0          | 172165-1  | 794184-1                    |
|                    |          |                | Duplex <sup>2</sup> | 1-770166-1                       | 1-770872-1          |   |                             |
| 3                  | In-Line  | .550<br>13.97  | Tin <sup>1</sup>    | 1-770170-0                       | 1-770873-0          | 172166-1  | 794186-1                    |
|                    |          |                | Duplex <sup>2</sup> | 1-770170-1                       | 1-770873-1          |   |                             |
| 4                  | Dual Row | .387<br>9.83   | Tin <sup>1</sup>    | 1-770174-0                       | 1-770874-0          | 172167-1  | 794188-1                    |
|                    |          |                | Duplex <sup>2</sup> | 1-770174-1                       | 1-770874-1          |   |                             |
| 6                  | Dual Row | .550<br>13.97  | Tin <sup>1</sup>    | 1-770178-0                       | 1-770875-0          | 172168-1  | 794190-1                    |
|                    |          |                | Duplex <sup>2</sup> | 1-770178-1                       | 1-770875-1          |   |                             |
| 8                  | Dual Row | .713<br>18.11  | Tin <sup>1</sup>    | 1-794065-0                       | 1-794073-0          | 770579-1  | 794192-1                    |
|                    |          |                | Duplex <sup>2</sup> | 1-794065-1                       | 1-794073-1          |   |                             |
| 9                  | Matrix   | .551<br>14.00  | Tin <sup>1</sup>    | 1-770182-0                       | 1-770876-0          | 172169-1  | 794194-1                    |
|                    |          |                | Duplex <sup>2</sup> | 1-770182-1                       | 1-770876-1          |   |                             |
| 10                 | Dual Row | .877<br>22.28  | Tin <sup>1</sup>    | 1-770743-0                       | 1-770858-0          | 770580-1  | 794196-1                    |
|                    |          |                | Duplex <sup>2</sup> | 1-770743-1                       | 1-770858-1          |   |                             |
| 12                 | Dual Row | 1.039<br>26.39 | Tin <sup>1</sup>    | 1-794066-0                       | 1-770621-0          | 770581-1  | 794198-1                    |
|                    |          |                | Duplex <sup>2</sup> | 1-794066-1                       | 1-770621-1          |   |                             |
| 12                 | Matrix   | .713<br>18.11  | Tin <sup>1</sup>    | 1-770186-0                       | 1-794040-0          | 172170-1  | 794200-1                    |
|                    |          |                | Duplex <sup>2</sup> | 1-770186-1                       | 1-794040-1          |   |                             |
| 14                 | Dual Row | 1.202<br>30.53 | Tin <sup>1</sup>    | 1-794067-0                       | 1-794074-0          | 770582-1  | 794202-1                    |
|                    |          |                | Duplex <sup>2</sup> | 1-794067-1                       | 1-794074-1          |   |                             |
| 15                 | Matrix   | .877<br>22.28  | Tin <sup>1</sup>    | 1-770190-0                       | 1-770859-0          | 172171-1  | 794204-1                    |
|                    |          |                | Duplex <sup>2</sup> | 1-770190-1                       | 1-770859-1          |   |                             |
| 16                 | Dual Row | 1.365<br>34.67 | Tin <sup>1</sup>    | 1-794068-0                       | 1-794075-0          | 770583-1  | 794206-1                    |
|                    |          |                | Duplex <sup>2</sup> | 1-794068-1                       | 1-794075-1          |   |                             |
| 18                 | Dual Row | 1.528<br>38.81 | Tin <sup>1</sup>    | 1-794069-0                       | 1-794076-0          | 770584-1  | 794208-1                    |
|                    |          |                | Duplex <sup>2</sup> | 1-794069-1                       | 1-794076-1          |   |                             |
| 20                 | Dual Row | 1.691<br>42.95 | Tin <sup>1</sup>    | 1-794070-0                       | 1-794077-0          | 770585-1  | 794210-1                    |
|                    |          |                | Duplex <sup>2</sup> | 1-794070-1                       | 1-794077-1          |   |                             |
| 22                 | Dual Row | 1.854<br>47.09 | Tin <sup>1</sup>    | 1-794071-0                       | 1-794078-0          | 770586-1  | 794212-1                    |
|                    |          |                | Duplex <sup>2</sup> | 1-794071-1                       | 1-794078-1          |   |                             |
| 24                 | Dual Row | 2.017<br>51.23 | Tin <sup>1</sup>    | 1-794072-0                       | 1-794079-0          | 770587-1  | 794214-1                    |
|                    |          |                | Duplex <sup>2</sup> | 1-794072-1                       | 1-794079-1          |   |                             |

<sup>1</sup>Tin Finish—Plated with .000150 [.00381] min. tin over .000050 [.00127] min. nickel underplate on entire contact.

<sup>2</sup>Duplex Finish—Plated with .000030 [.000762] min. gold in mating area and matte tin on solder tail end over .000050 [.00127] min. nickel underplate on entire contact.

**Note:** All part numbers are RoHS Compliant.

**Mini-Universal MATE-N-LOK 2 Connectors** (Continued)

**Vertical PC Board  
Blindmate Pin Headers**

.163 [4.14] Centerline spacing

**Material**

**Housing**— Nylon, white

**Flammability Rating**— UL94V-0

**Contacts**— Brass  
Solder tail diameter .039 [1.00]

**Related Product Data**

**Product Specifications**

108-1693 Mini-Universal MATE-N-LOK 2 Connectors

108-1694 Mini-Universal MATE-N-LOK 2 Headers

**Performance Characteristics**— pages 99-100

**Recommended PC Board Hole Layout**—page 106

**Technical Documents**— pages 99 and 205-206

**Mating Connectors**

**Mini-Universal MATE-N-LOK 2**  
Plug Housings—pages 101-102

**Mini-Universal MATE-N-LOK**  
Plug Housings—pages 87-89

**4, 6, 8 and 10 Circuit,  
Dual Row**



**9, 12 and 15 Circuit,  
Matrix**

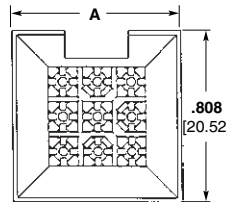

| Number of Circuits | Style    | A Dim.         | Pin Finish          | Pin Header Part Numbers with Drain Holes | Mates with Plug Housing Part Number (Using Socket Contacts) |                             |
|--------------------|----------|----------------|---------------------|--|---|-----------------------------|
|                    |          |                |                     |  | Mini-Universal MATE-N-LOK                                   | Mini-Universal MATE-N-LOK 2 |
| 4                  | Dual Row | .645<br>16.38  | Tin <sup>1</sup>    | 1-794325-0                               | 172167-1  | 794188-1                    |
|                    |          |                | Duplex <sup>2</sup> | 1-794325-1                               |   |                             |
| 6                  | Dual Row | .808<br>20.52  | Tin <sup>1</sup>    | 1-794326-0                               | 172168-1  | 794190-1                    |
|                    |          |                | Duplex <sup>2</sup> | 1-794326-1                               |   |                             |
| 8                  | Dual Row | .971<br>24.66  | Tin <sup>1</sup>    | 1-794327-0                               | 770579-1  | 794192-1                    |
|                    |          |                | Duplex <sup>2</sup> | 1-794327-1                               |   |                             |
| 9                  | Matrix   | .808<br>20.52  | Tin <sup>1</sup>    | 1-794432-0                               | 172169-1  | 794194-1                    |
|                    |          |                | Duplex <sup>2</sup> | 1-794432-1                               |   |                             |
| 10                 | Dual Row | 1.134<br>28.80 | Tin <sup>1</sup>    | 1-794328-0                               | 770580-1  | 794196-1                    |
|                    |          |                | Duplex <sup>2</sup> | 1-794328-1                               |   |                             |
| 12                 | Matrix   | .971<br>24.66  | Tin <sup>1</sup>    | 1-794329-0                               | 172170-1  | 794200-1                    |
|                    |          |                | Duplex <sup>2</sup> | 1-794329-1                               |   |                             |
| 15                 | Matrix   | 1.134<br>28.80 | Tin <sup>1</sup>    | 1-794330-0                               | 172171-1  | 794204-1                    |
|                    |          |                | Duplex <sup>2</sup> | 1-794330-1                               |   |                             |

<sup>1</sup>Tin Finish—Plated with .000150 [.00381] min. tin over .000050 [.00127] min. nickel underplate on entire contact.  
<sup>2</sup>Duplex Finish—Plated with .000030 [.000762] min. gold in mating area and matte tin on solder tail end over .000050 [.00127] min. nickel underplate on entire contact.

**Note:** All part numbers are RoHS Compliant.

Mini-Universal MATE-N-LOK 2 Connectors .163 [4.14] Centerline

High Density



**Mini-Universal MATE-N-LOK 2 Connectors** (Continued)

**Right-Angle PC Board Pin Headers**

.163 [4.14] Centerline spacing

**Material**

**Housing**— Nylon, white color

**Flammability Rating**— UL94V-0

**Contacts**— Brass

Solder tail diameter .039 [1.00]

**Related Product Data**

**Product Specification**

108-1694 Mini-Universal MATE-N-LOK 2 Headers

**Performance Characteristics**— pages 99-100

**Recommended PC Board Hole Layout**— page 106

**Technical Documents**— pages 99 and 205-206

**Mating Connectors**

**Mini-Universal MATE-N-LOK 2**

Plug Housings— pages 101-102

**Mini-Universal MATE-N-LOK**

Plug Housings— pages 87-89

**With Board Lock Feature**  
**2 and 3 Circuit, In-Line**

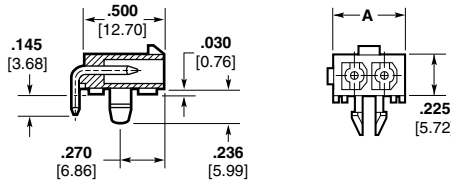

**4, 6, 8, 10 and 12 Circuit, Dual Row**

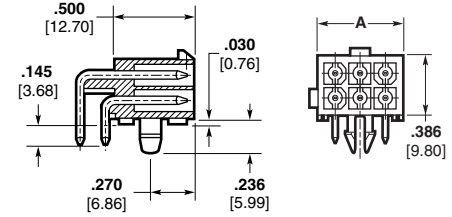

**14, 16, 18, 20, 22 and 24 Circuit, Dual Row**

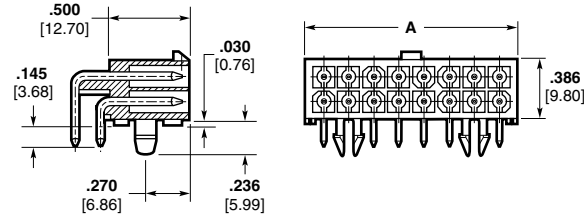

| Number of Circuits | Style    | A Dim.         | Pin Finish          | Pin Header Part Number with Board Lock | Mates with Plug Housing Part Number (Using Socket Contacts) |                             |
|--------------------|----------|----------------|---------------------|--|---|-----------------------------|
|                    |          |                |                     |  | Mini-Universal MATE-N-LOK                                   | Mini-Universal MATE-N-LOK 2 |
| 2                  | In-line  | .388<br>9.86   | Tin <sup>1</sup>    | 1-770966-0                             | 172165-1  | 794184-1                    |
|                    |          |                | Duplex <sup>2</sup> | 1-770966-1                             |   |                             |
| 3                  | In-line  | .551<br>14.00  | Tin <sup>1</sup>    | 1-770967-0                             | 172166-1  | 794186-1                    |
|                    |          |                | Duplex <sup>2</sup> | 1-770967-1                             |   |                             |
| 4                  | Dual Row | .388<br>9.86   | Tin <sup>1</sup>    | 1-770968-0                             | 172167-1  | 794188-1                    |
|                    |          |                | Duplex <sup>2</sup> | 1-770968-1                             |   |                             |
| 6                  | Dual Row | .551<br>14.00  | Tin <sup>1</sup>    | 1-770969-0                             | 172168-1  | 794190-1                    |
|                    |          |                | Duplex <sup>2</sup> | 1-770969-1                             |   |                             |
| 8                  | Dual Row | .714<br>18.14  | Tin <sup>1</sup>    | 1-770970-0                             | 770579-1  | 794192-1                    |
|                    |          |                | Duplex <sup>2</sup> | 1-770970-1                             |   |                             |
| 10                 | Dual Row | .877<br>22.28  | Tin <sup>1</sup>    | 1-770971-0                             | 770580-1  | 794196-1                    |
|                    |          |                | Duplex <sup>2</sup> | 1-770971-1                             |   |                             |
| 12                 | Dual Row | 1.040<br>26.42 | Tin <sup>1</sup>    | 1-770972-0                             | 770581-1  | 794198-1                    |
|                    |          |                | Duplex <sup>2</sup> | 1-770972-1                             |   |                             |
| 14                 | Dual Row | 1.203<br>30.56 | Tin <sup>1</sup>    | 1-770973-0                             | 770582-1  | 794202-1                    |
|                    |          |                | Duplex <sup>2</sup> | 1-770973-1                             |   |                             |
| 16                 | Dual Row | 1.366<br>34.70 | Tin <sup>1</sup>    | 1-770974-0                             | 770583-1  | 794206-1                    |
|                    |          |                | Duplex <sup>2</sup> | 1-770974-1                             |   |                             |
| 18                 | Dual Row | 1.529<br>38.84 | Tin <sup>1</sup>    | 1-794105-0                             | 770584-1  | 794208-1                    |
|                    |          |                | Duplex <sup>2</sup> | 1-794105-1                             |   |                             |
| 20                 | Dual Row | 1.692<br>42.98 | Tin <sup>1</sup>    | 1-794106-0                             | 770585-1  | 794210-1                    |
|                    |          |                | Duplex <sup>2</sup> | 1-794106-1                             |   |                             |
| 22                 | Dual Row | 1.855<br>47.12 | Tin <sup>1</sup>    | 1-794107-0                             | 770586-1  | 794212-1                    |
|                    |          |                | Duplex <sup>2</sup> | 1-794107-1                             |   |                             |
| 24                 | Dual Row | 2.018<br>51.26 | Tin <sup>1</sup>    | 1-794108-0                             | 770587-1  | 794214-1                    |
|                    |          |                | Duplex <sup>2</sup> | 1-794108-1                             |   |                             |

<sup>1</sup>Tin Finish— Plated with .000150 [.00381] min. tin over .000050 [.00127] min. nickel underplate on entire contact.  
<sup>2</sup>Duplex Finish— Plated with .000030 [.000762] min. gold in mating area and matte tin on solder tail end over .000050 [.00127] min. nickel underplate on entire contact.

**Note:** All part numbers are RoHS Compliant.

**Mini-Universal MATE-N-LOK 2 Connectors** (Continued)

**Recommended PC Board Hole Layouts for Vertical and Blindmate Headers**

.062 [1.57] thick board, tolerances non-accumulative

**Related Product Data**

**Vertical Headers**—pages 103-104

**2 and 3 Circuit, In-Line**



**4, 6, 8, 10 and 12 Circuit, Dual Row**



**9, 12 and 15 Circuit, Matrix**

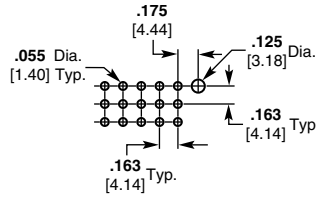

**14, 16, 18, 20, 22 and 24 Circuit, Dual Row**

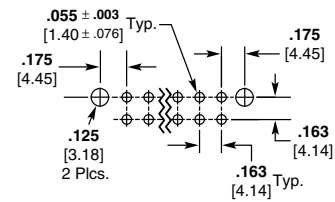

**Recommended PC Board Hole Layouts for Right-Angle Headers**

.062 [1.57] thick board, tolerances non-accumulative

**Related Product Data**

**Right-Angle Headers**—page 105

**2 Circuit**



**3 Circuit**



**4, 8 and 12 Circuit**



**6 and 10 Circuit**



**14 and 18 Circuit**



**22 Circuit**

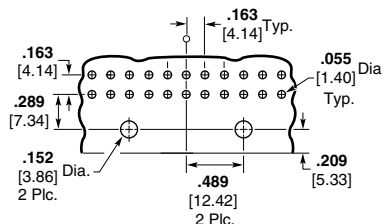

**16, 20 and 24 Circuit**



High Density

Mini-Universal MATE-N-LOK 2 Connectors  
.163 [4.14] Centerline

**Mini-Universal MATE-N-LOK 2 Connectors** (Continued)

**Mini-Universal  
MATE-N-LOK 2 Connector  
Mating Combinations**

| Number of Circuits | Connector Part Number |          |                                    |                                   | Mating Connector Part Number            |                                   |                              |                          |                          |
|--------------------|-----------------------|----------|------------------------------------|-----------------------------------|---|-----------------------------------|------------------------------|--------------------------|--------------------------|
|                    | Flammability Rating   | Style    | Plug <sup>1</sup> Housing Part No. | Cap <sup>1</sup> Housing Part No. | Plating                                 | PC Board Pin Headers <sup>4</sup> |                              |                          | Right-Angle Board Lock   |
|                    |                       |          |                                    |                                   |   | With Drain Holes                  | Vertical Without Drain Holes | Blindmate                |                          |
| 2                  | UL94V-2               | In-Line  | 794237-1                           | 794238-1                          | —                                       | —                                 | —                            | —                        | —                        |
|                    | UL94V-0               | In-Line  | 794184-1                           | 794185-1                          | Tin <sup>3</sup><br>Duplex <sup>2</sup> | 1-770166-0<br>1-770166-1          | 1-770872-0<br>1-770872-1     | —<br>—                   | 1-770966-0<br>1-770966-1 |
| 3                  | UL94V-2               | In-Line  | 794239-1                           | 794240-1                          | —                                       | —                                 | —                            | —                        | —                        |
|                    | UL94V-0               | In-Line  | 794186-1                           | 794187-1                          | Tin <sup>3</sup><br>Duplex <sup>2</sup> | 1-770170-0<br>1-770170-1          | 1-770873-0<br>1-770873-1     | —<br>—                   | 1-770967-0<br>1-770967-1 |
| 4                  | UL94V-2               | Dual Row | 794241-1                           | 794242-1                          | —                                       | —                                 | —                            | —                        | —                        |
|                    | UL94V-0               | Dual Row | 794188-1                           | 794189-1                          | Tin <sup>3</sup><br>Duplex <sup>2</sup> | 1-770174-0<br>1-770174-1          | 1-770874-0<br>1-770874-1     | 1-794325-0<br>1-794325-1 | 1-770968-0<br>1-770968-1 |
| 6                  | UL94V-2               | Dual Row | 794243-1                           | 794244-1                          | —                                       | —                                 | —                            | —                        | —                        |
|                    | UL94V-0               | Dual Row | 794190-1                           | 794191-1                          | Tin <sup>3</sup><br>Duplex <sup>2</sup> | 1-770178-0<br>1-770178-1          | 1-770875-0<br>1-770875-1     | 1-794326-0<br>1-794326-1 | 1-770969-0<br>1-770969-1 |
| 8                  | UL94V-2               | Dual Row | 794245-1                           | 794246-1                          | —                                       | —                                 | —                            | —                        | —                        |
|                    | UL94V-0               | Dual Row | 794192-1                           | 794193-1                          | Tin <sup>3</sup><br>Duplex <sup>2</sup> | 1-794065-0<br>1-794065-1          | 1-794073-0<br>1-794073-1     | 1-794327-0<br>1-794327-1 | 1-770970-0<br>1-770970-1 |
| 9                  | UL94V-2               | Matrix   | 794247-1                           | 794248-1                          | —                                       | —                                 | —                            | —                        | —                        |
|                    | UL94V-0               | Matrix   | 794194-1                           | 794195-1                          | Tin <sup>3</sup><br>Duplex <sup>2</sup> | 1-770182-0<br>1-770182-1          | 1-770876-0<br>1-770876-1     | 1-794432-0<br>1-794432-1 | —<br>—                   |
| 10                 | UL94V-2               | Dual Row | 794249-1                           | 794250-1                          | —                                       | —                                 | —                            | —                        | —                        |
|                    | UL94V-0               | Dual Row | 794196-1                           | 794197-1                          | Tin <sup>3</sup><br>Duplex <sup>2</sup> | 1-770743-0<br>1-770743-1          | 1-770858-0<br>1-770858-1     | 1-794328-0<br>1-794328-1 | 1-770971-0<br>1-770971-1 |
| 12                 | UL94V-2               | Matrix   | 794253-1                           | 794254-1                          | —                                       | —                                 | —                            | —                        | —                        |
|                    |                       | Dual Row | 794251-1                           | 794252-1                          | —                                       | —                                 | —                            | —                        | —                        |
|                    | UL94V-0               | Matrix   | 794200-1                           | 794201-1                          | Tin <sup>3</sup><br>Duplex <sup>2</sup> | 1-770186-0<br>1-770186-1          | 1-794040-0<br>1-794040-1     | 1-794329-0<br>1-794329-1 | —<br>—                   |
|                    |                       | Dual Row | 794198-1                           | 794199-1                          | Tin <sup>3</sup><br>Duplex <sup>2</sup> | 1-794066-0<br>1-794066-1          | 1-770621-0<br>1-770621-1     | —<br>—                   | 1-770972-0<br>1-770972-1 |
| 14                 | UL94V-2               | Dual Row | 794255-1                           | 794256-1                          | —                                       | —                                 | —                            | —                        | —                        |
|                    | UL94V-0               | Dual Row | 794202-1                           | 794203-1                          | Tin <sup>3</sup><br>Duplex <sup>2</sup> | 1-794067-0<br>1-794067-1          | 1-794074-0<br>1-794074-1     | —<br>—                   | 1-770973-0<br>1-770973-1 |
| 15                 | UL94V-2               | Matrix   | 794257-1                           | 794258-1                          | —                                       | —                                 | —                            | —                        | —                        |
|                    | UL94V-0               | Matrix   | 794204-1                           | 794205-1                          | Tin <sup>3</sup><br>Duplex <sup>2</sup> | 1-770190-0<br>1-770190-1          | 1-770859-0<br>1-770859-1     | 1-794330-0<br>1-794330-1 | —<br>—                   |
| 16                 | UL94V-2               | Dual Row | 794259-1                           | 794260-1                          | —                                       | —                                 | —                            | —                        | —                        |
|                    | UL94V-0               | Dual Row | 794206-1                           | 794207-1                          | Tin <sup>3</sup><br>Duplex <sup>2</sup> | 1-794068-0<br>1-794068-1          | 1-794075-0<br>1-794075-1     | —<br>—                   | 1-770974-0<br>1-770974-1 |
| 18                 | UL94V-2               | Dual Row | 794261-1                           | 794262-1                          | —                                       | —                                 | —                            | —                        | —                        |
|                    | UL94V-0               | Dual Row | 794208-1                           | 794209-1                          | Tin <sup>3</sup><br>Duplex <sup>2</sup> | 1-794069-0<br>1-794069-1          | 1-794076-0<br>1-794076-1     | —<br>—                   | 1-794105-0<br>1-794105-1 |
| 20                 | UL94V-2               | Dual Row | 794263-1                           | 794264-1                          | —                                       | —                                 | —                            | —                        | —                        |
|                    | UL94V-0               | Dual Row | 794210-1                           | 794211-1                          | Tin <sup>3</sup><br>Duplex <sup>2</sup> | 1-794070-0<br>1-794070-1          | 1-794077-0<br>1-794077-1     | —<br>—                   | 1-794106-0<br>1-794106-1 |
| 22                 | UL94V-2               | Dual Row | 794265-1                           | 794266-1                          | —                                       | —                                 | —                            | —                        | —                        |
|                    | UL94V-0               | Dual Row | 794212-1                           | 794213-1                          | Tin <sup>3</sup><br>Duplex <sup>2</sup> | 1-794071-0<br>1-794071-1          | 1-794078-0<br>1-794078-1     | —<br>—                   | 1-794107-0<br>1-794107-1 |
| 24                 | UL94V-2               | Dual Row | 794267-1                           | 794268-1                          | —                                       | —                                 | —                            | —                        | —                        |
|                    | UL94V-0               | Dual Row | 794214-1                           | 794215-1                          | Tin <sup>3</sup><br>Duplex <sup>2</sup> | 1-794072-0<br>1-794072-1          | 1-794079-0<br>1-794079-1     | —<br>—                   | 1-794108-0<br>1-794108-1 |

<sup>1</sup>Mini-Universal MATE-N-LOK 2 plug and cap housings accept pin or socket contacts. Use the appropriate contacts in the plug housing as required by the mating connector. All **Plugs** and **Caps** are **free-hanging**.

<sup>2</sup>Duplex Finish — Plated with .000030 [.000762] min. gold in mating area and matte tin on solder tail end over .000050 [.00127] min. nickel underplate on entire contact.

<sup>3</sup>Tin Finish — Plated with .000150 [.00381] min. tin over .000050 [.00127] min nickel underplate on entire contact.

<sup>4</sup>All PC Board pin headers have 94V-0 flammability rating and can mate to V-0 or V-2 plug housings.

**Note:** All part numbers are RoHS Compliant.

High Density

Mini-Universal MATE-N-LOK 2 Connectors  
.163 [4.14] Centerline

---

**Engineering Notes**

---



## (MR) Miniature Rectangular Connectors

### Product Facts

- Housings positively lock to help prevent accidental disengagement
- Either cap or plug housing can be mounted in same rectangular panel cutout without additional hardware
- UL94V-0 housings
- Plug and cap design includes molded-in polarizing feature for proper mating
- Numbered cavities for easy circuit identification
- Egg crate design of plug half fully encloses socket contacts, reducing shock hazard
- Molded skirt extension on cap protects pin contacts
- Strain reliefs for 6 through 36 positions are available
- Choice of tin or gold plated contacts
- Not for interrupting current
- Socket solder tail contacts available for hot side PC Board mounting
- High density achieved through .165 [4.19] contact centerline spacing
- Extraction tool removes both pins and sockets
- Contacts accept 26-18 AWG [.12-.8 mm<sup>2</sup>] wire sizes and insulation diameters of .025-.115 [.635-2.92]
- Same applicator crimps pins and sockets
- Vertical PC Board pin headers are available
- Pin header standoffs on housings at board interface facilitates gas venting and cooling during soldering
- Recognized under the Component Program of Underwriters Laboratories Inc., File No. E28476
- Certified by Canadian Standards Association, File No. LR 7189

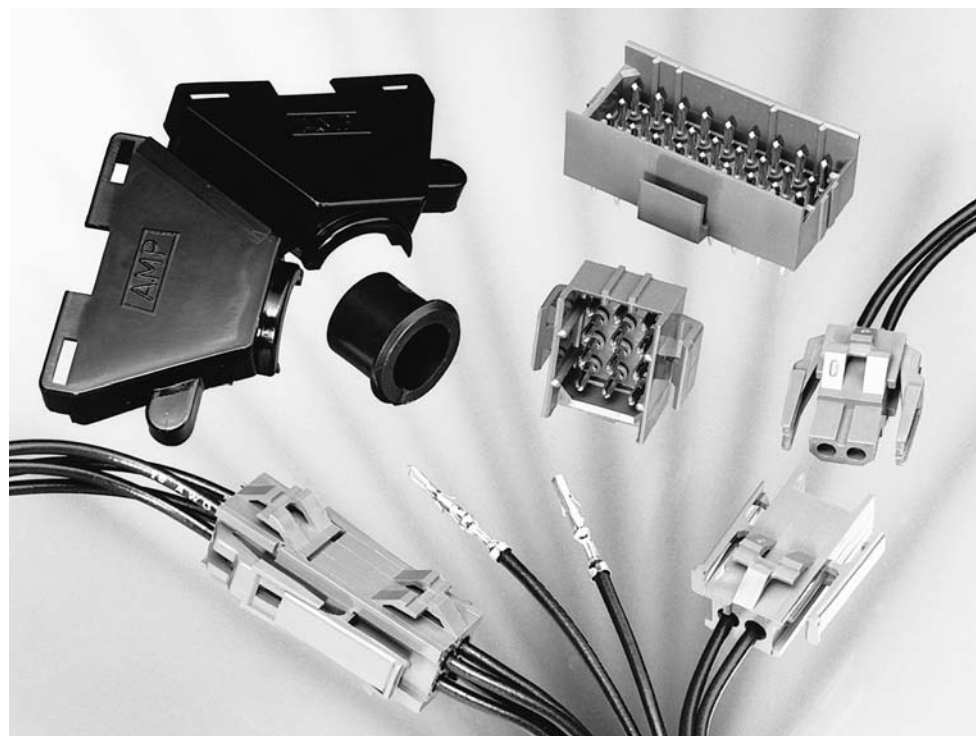

### Performance Characteristics

The Miniature Rectangular Connector performance characteristics found on pages 109-110 are based on free-hanging and panel mount connectors, loaded with contacts crimped on stranded wire.

**Dielectric Withstanding Voltage**—2.5 KVAC between adjacent circuits

**Insulation Resistance**—1500 megohms minimum initial between adjacent circuits

**Voltage Rating**—250 V AC

**Connector Mating**—Split Pin—1.0 lb. max. per circuit

**Connector Unmating**—Split Pin—.25 lb. min. per circuit

**Contact Insertion Force**—1.75 lb. max. per contact

**Contact Retention**—10 lb. min. per contact

**Durability**—25 cycles, mating and unmating

### Technical Documents

#### Product Specifications

108-1022 (MR) Miniature Rectangular Connectors

108-1078 (MR) Miniature Rectangular Headers

#### Application Specification

114-1014 (MR) Miniature Rectangular Contacts

#### Instruction Sheet

408-3231 Pin, Socket, Housing, Contacts, and Accessories

**(MR) Miniature Rectangular Connectors** (Continued)

**Performance Characteristics**

(Continued)

**Maximum Current**—Maximum current rating of Miniature Rectangular connectors is limited by the maximum operating temperature of the housings which is 105°C including the temperature rise of the contacts which is a maximum of 30°C. There are several variables which have a direct effect on this maximum current-carrying capability for a given connector and must be considered for each application. These variables are:

**Wire Size**—Larger diameter wire will carry more current since it has less internal resistance to current flow and thus generates less heat. Longer wire lengths also enhance current-carrying capabilities since the wire conducts heat away from the connector.

**Connector Size**—In general, the more circuits in a connector, the less current can be carried.

**Ambient Temperature**—The higher the ambient temperature, the less current can be carried in any given connector.

**Printed Wiring Board Conductor Size**—The finished trace conductor width and thickness should be maximized to allow for the greatest current-carrying capacity and heat dissipation.

Miniature Rectangular connectors also will withstand the following tests:

**Vibration**—10-55-10 cycles per minute at .06 inch total excursion

**Physical Shock**—18 drops, 50 G sawtooth at 10 milliseconds

**Housing Panel Retention**—50 lb. min.

**Housing Lock Strength**—20 lb. min.

**Thermal Shock**—-55°C to +85°C

**Temperature-Humidity Cycling**—25°C to 65°C at 95 RH

**Corrosion**—48 hr. at 5% salt concentration

**Current Rating Verification for 30°C Maximum Temperature Rise 100% Energized**

**Wire-to-Wire  
MR Calculated Current Table**

| Number of Circuits | Wire Gauge |      |      |      |      |
|--------------------|------------|------|------|------|------|
|                    | 18         | 20   | 22   | 24   | 26   |
| 2                  | 9.00       | 8.00 | 6.50 | 5.50 | 5.00 |
| 3                  | 8.50       | 7.00 | 6.00 | 5.00 | 4.50 |
| 4                  | 7.00       | 6.50 | 5.50 | 5.00 | 4.00 |
| 6                  | 6.00       | 6.00 | 5.00 | 4.00 | 4.00 |
| 9                  | 5.00       | 5.00 | 4.00 | 4.00 | 3.50 |
| 12                 | 4.50       | 4.50 | 4.00 | 3.50 | 3.00 |
| 15                 | 4.50       | 4.00 | 3.50 | 3.00 | 2.50 |
| 20                 | 4.00       | 4.00 | 3.50 | 3.00 | 2.50 |
| 24                 | 4.00       | 3.50 | 3.00 | 2.50 | 2.00 |
| 36                 | 3.50       | 3.00 | 2.50 | 2.00 | 2.00 |

Values are based on initial Temperature Rise versus Current Testing and are intended to be a guide in the selection of a connector family. All applications should be tested by the end user. The values listed are per circuit for fully loaded housings being 100% energized. **Note:** All combinations were not tested and this chart contains interpolated and extrapolated values.

**Minimum Wire Lengths for T-Rise vs. Current Testing**

| AWG | Min. Length (in.) | AWG | Min. Length (in.) |
|-----|-------------------|-----|-------------------|
| 30  | 2.6               | 18  | 9.4               |
| 28  | 3.2               | 16  | 11.3              |
| 26  | 4.1               | 14  | 13.7              |
| 24  | 5.1               | 12  | 16.4              |
| 20  | 7.8               | 10  | 19.3              |

**Note:** If wire lengths used are less than those listed above, the current-carrying ability of the system will be reduced due to less heat being conducted away from the connector. The customer should fully test all applications.

**Wire-to-Board**

Due to the vast differences in trace geometry and printed circuit board configurations, we are unable to provide a separate current carrying chart for our printed circuit board header products. However, the above Wire-to-Wire charts may be used as a guideline for headers if the trace width and thickness is equal to the listed wire gauge. For vertical headers, only 95% of the Wire-to-Wire value should be used. For right-angle headers, only 75% of the Wire-to-Wire value should be used. The charted values are only a tool for connector selection and will require the customer to fully test their application.

**Termination Resistance/Contact Crimp Tensile Force**

| Wire Size | Termination Resistance | Contact Crimp Tensile Force |                                     |      |     |
|-----------|------------------------|-----------------------------|-------------------------------------|------|-----|
|           |                        | Test Current (Amps)         | Resistance (Milliohms (Max. Init.)) | lbs. | N   |
| 26        | .12                    | 1                           | 5.00                                | 5    | 22  |
| 24        | .2                     | 1.5                         | 5.00                                | 8    | 36  |
| 22        | .3                     | 3                           | 4.50                                | 14   | 62  |
| 20        | .5                     | 4.5                         | 4.00                                | 14   | 62  |
| 18        | .8                     | 6                           | 4.00                                | 30   | 133 |

**Note:** This is the total resistance between wire crimps of a mated pin and socket.

**Related Product Data**

**Product Specifications**

108-1022 (MR) Miniature Rectangular Connectors

108-1078 (MR) Miniature Rectangular Headers

High Density  
(MR) Miniature Rectangular Connectors  
.165 [4.20] Centerline

**(MR) Miniature Rectangular Connectors** (Continued)

**(MR) Miniature Rectangular Connector Mating Combinations**

| Connector Part Number |                     |         |                            | Mating Connector Part Number   |                               |            |            |
|-----------------------|---------------------|---------|----------------------------|--------------------------------|-------------------------------|------------|------------|
| Number of Circuits    | Flammability Rating | Style   | Pin Housing (Cap) Part No. | Socket Housing (Plug) Part No. | PC Board Vertical Pin Headers |            |            |
|                       |                     |         |                            |                                | Plating                       | .062 Board | .120 Board |
| 2                     | UL94V-0             | In-Line | 1-640507-0                 | 1-640517-0                     | Tin                           | 640497-1   | 640497-3   |
|                       |                     |         |                            |                                | Duplex <sup>1</sup>           | 2-640497-2 | 2-640497-4 |
| 3                     | UL94V-0             | In-Line | 1-640508-0                 | 1-640518-0                     | Tin                           | 640498-1   | 640498-3   |
|                       |                     |         |                            |                                | Duplex <sup>1</sup>           | 2-640498-2 | 2-640498-4 |
| 4                     | UL94V-0             | Matrix  | 1-640509-0                 | 1-640519-0                     | Tin                           | 640499-1   | 640499-3   |
|                       |                     |         |                            |                                | Duplex <sup>1</sup>           | 2-640499-2 | 2-640499-4 |
| 6                     | UL94V-0             | Matrix  | 1-640510-0                 | 1-640520-0                     | Tin                           | 640500-1   | 640500-3   |
|                       |                     |         |                            |                                | Duplex <sup>1</sup>           | 2-640500-2 | 2-640500-4 |
| 9                     | UL94V-0             | Matrix  | 1-640511-0                 | 1-640521-0                     | Tin                           | 640501-1   | 640501-3   |
|                       |                     |         |                            |                                | Duplex <sup>1</sup>           | 2-640501-2 | 2-640501-4 |
| 12                    | UL94V-0             | Matrix  | 1-640512-0                 | 1-640522-0                     | Tin                           | 640502-1   | 640502-3   |
|                       |                     |         |                            |                                | Duplex <sup>1</sup>           | 2-640502-2 | 2-640502-4 |
| 15                    | UL94V-0             | Matrix  | 1-640513-0                 | 1-640523-0                     | Tin                           | 640503-1   | 640503-3   |
|                       |                     |         |                            |                                | Duplex <sup>1</sup>           | 2-640503-2 | 2-640503-4 |
| 20                    | UL94V-0             | Matrix  | 1-640514-0                 | 1-640524-0                     | Tin                           | 640504-1   | 640504-3   |
|                       |                     |         |                            |                                | Duplex <sup>1</sup>           | 2-640504-2 | 2-640504-4 |
| 24                    | UL94V-0             | Matrix  | 1-640515-0                 | 1-640525-0                     | Tin                           | 640505-1   | 640505-3   |
|                       |                     |         |                            |                                | Duplex <sup>1</sup>           | 2-640505-2 | 2-640505-4 |
| 36                    | UL94V-0             | Matrix  | 1-640516-0                 | 1-640526-0                     | Tin                           | 640506-1   | 640506-3   |
|                       |                     |         |                            |                                | Duplex <sup>1</sup>           | 2-640506-2 | 2-640506-4 |

<sup>1</sup>Duplex Finish — Plated with .000030 [.000762] min. gold in mating area, matte tin on solder tail end over .000050 [.00127] min. nickel underplate on entire contact.

**Note:** All part numbers are RoHS Compliant.

High Density

(MR) Miniature Rectangular Connectors  
.165 [4.20] Centerline

**(MR) Miniature Rectangular Connectors (Continued)**

**Contacts**

Pin diameter .068 [1.73]

**Material**

Phosphor bronze  
Stock thickness .008 [.203]

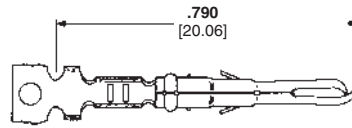

**Live Split Pin**

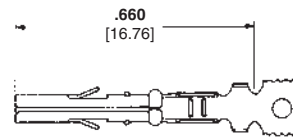

**Standard Socket**

| Wire Size Range<br>AWG [mm <sup>2</sup> ] | Ins. Dia. Range        | Finish                   | Contact Part Numbers |             |                 |             | HDM Applicator Part No.                        | Hand Tool Part No. |
|---|------------------------|--------------------------|----------------------|-------------|-----------------|-------------|--|--------------------|
|   |                        |                          | Live Split Pin       |             | Standard Socket |             |  |                    |
|   |                        |                          | Strip Form           | Loose Piece | Strip Form      | Loose Piece |  |                    |
| 26-24<br>[.12-.2]                         | .025-.050<br>.635-1.27 | Pre-tin                  | 350968-1             | 640579-1    | 794000-1        | 794001-1    | 466352-1 <sup>3</sup>                          | 91534-1            |
|   |                        | Select Gold <sup>1</sup> | 350968-2             | 640579-2    | 794000-2        | 794001-2    | 466352-3 <sup>3</sup>                          |                    |
| 26-18 <sup>2</sup><br>[.12-.8]            | .050-.115<br>1.27-2.92 | Pre-tin                  | 350967-1             | 640545-1    | 641294-1        | 641300-1    | 466351-1 <sup>3</sup>                          | 91526-1            |
|   |                        | Select Gold <sup>1</sup> | 350967-2             | 640545-2    | 641294-2        | 641300-2    | 466351-2 <sup>3</sup><br>466351-4 <sup>3</sup> |                    |

<sup>1</sup>Select Gold Finish—Plated with .000030 min. [.000762] gold in mating area over .000050 [.00127] min. nickel underplate on entire contact.

<sup>2</sup>1650 CMA maximum.

<sup>3</sup>HDM Applicator part number ending in -1 is used on AMPOMATOR CLS Machine with T or G Terminators, -2 is used on AMP-O-LECTRIC Model K Machine, -3 or -4 is used on AMP-O-LECTRIC Model G Machine. See pages 207-210 for further information.

**Grounding Pins**

(Mate first, break last, not for interrupting current)

Pin diameter .068 [1.73]

Stock thickness .008 [.203]

**Material**

Phosphor bronze

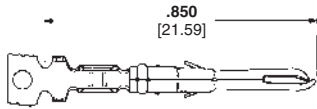

| Wire Size Range<br>AWG [mm <sup>2</sup> ] | Ins. Dia. Range        | Finish                   | Grounding Pin Part Numbers |             | HDM Applicator Part No.                        | Hand Tool Part No. |
|---|------------------------|--------------------------|----------------------------|-------------|--|--------------------|
|   |                        |                          | Strip Form                 | Loose Piece |  |                    |
| 26-18 <sup>2</sup><br>[.12-.8]            | .050-.115<br>1.27-2.92 | Pre-tin                  | 350969-1                   | 640580-1    | 466351-1 <sup>3</sup>                          | 91526-1            |
|   |                        | Select Gold <sup>1</sup> | 350969-2                   | 640580-2    | 466351-2 <sup>3</sup><br>466351-4 <sup>3</sup> |                    |

<sup>1</sup>Select Gold Finish—Plated with .000030 [.000762] min. gold in mating area over .000050 [.00127] min. nickel underplate on entire contact.

<sup>2</sup>1650 CMA maximum.

<sup>3</sup>HDM Applicator part number ending in -1 is used on AMPOMATOR CLS Machine with T or G Terminators, -2 is used on AMP-O-LECTRIC Model K Machine, -3 or -4 is used on AMP-O-LECTRIC Model G Machine. See pages 207-210 for further information.

**Solder Tail Socket**

**Material and Finish**

Phosphor bronze, pre-tin  
Stock thickness .008 [.203]

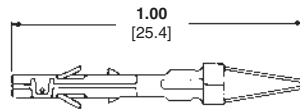

**Part Number 350838-1**

**Note:** Recommended for use with MR Socket Housings

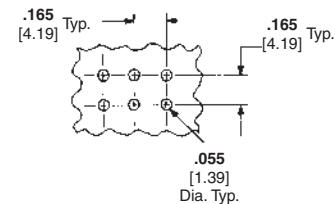

**Recommended PC Board Hole Layout**

.062 [1.57] or .093 [2.36] thick board

**Keying Plug**

IS 408-3231



**Part Number 350591-1**

UL94V-0 Nylon material

**Note:** Use in socket housings only.

**Related Product Data**

**Product Specification**

108-1022 (MR) Miniature Rectangular Connectors

**Application Specification**

114-1014 (MR) Miniature Rectangular Contacts

**Performance Characteristics**—pages 109-110

**Housings**—pages 113-114

**Technical Documents**—pages 109 and 205-206

**Application Tooling**—pages 207-210



**Contact Extraction Tool**  
Part No. 455822-2  
IS 408-9570



**Contact Insertion Tool**  
(For inserting contacts applied to small diameter wire)  
Part No. 455830-1  
IS 408-7984

**Note:** All part numbers are RoHS Compliant.



**(MR) Miniature Rectangular Connectors (Continued)**

**Housings**

**Free-Hanging or Panel Mount**

.165 [4.19] Centerline spacing

**Material**

Nylon, Natural (Color—Brick Red)

**Flammability Rating**—UL94V-0

**Related Product Data**

**Product Specification**

108-1022 (MR) Miniature Rectangular Connectors

**Performance Characteristics**—pages 109-110

**Panel Cutout Recommendations**—page 115

**Contacts**—page 112

**Keying Plug**—page 112

**Strain Reliefs**—page 116

**Commoning Bars**—page 116

**Technical Documents**—pages 109 and 205-206

**Mating Headers**—pages 117-118

**2 and 3 Circuit, In-Line**



| Number of Circuits | Dimensions    |               |               | Part Numbers      |                       |
|--------------------|---------------|---------------|---------------|-------------------|-----------------------|
|                    | A             | B             | C             | Pin Housing (Cap) | Socket Housing (Plug) |
| 2                  | .455<br>11.56 | .365<br>9.27  | .755<br>19.18 | 1-640507-0        | 1-640517-0            |
| 3                  | .620<br>15.75 | .530<br>13.46 | .920<br>23.37 | 1-640508-0        | 1-640518-0            |

**Note:** All part numbers are RoHS Compliant.

**4 and 6 Circuit, Matrix**



| Number of Circuits | A Dim.        | Part Numbers      |                       |
|--------------------|---------------|-------------------|-----------------------|
|                    |               | Pin Housing (Cap) | Socket Housing (Plug) |
| 4                  | .455<br>11.56 | 1-640509-0        | 1-640519-0            |
| 6                  | .620<br>15.75 | 1-640510-0        | 1-640520-0            |

**Note:** All part numbers are RoHS Compliant.

High Density  
**(MR) Miniature Rectangular Connectors**  
.165 [4.20] Centerline

**(MR) Miniature Rectangular Connectors (Continued)**

**Housings**

**Free-Hanging or Panel Mount**

.165 [4.19] Centerline spacing

**Material**

Nylon, Natural (Color—Brick Red)

**Flammability Rating**—UL94V-0

**Related Product Data**

**Product Specification**

108-1022 (MR) Miniature Rectangular Connectors

**Performance Characteristics**—pages 109-110

**Panel Cutout Recommendations**—page 115

**Contacts**—page 112

**Keying Plug**—page 112

**Strain Reliefs**—page 116

**Commoning Bars**—page 116

**Technical Documents**—pages 109 and 205-206

**Mating Headers**—pages 117-118

**9, 12 and 15 Circuit, Matrix**

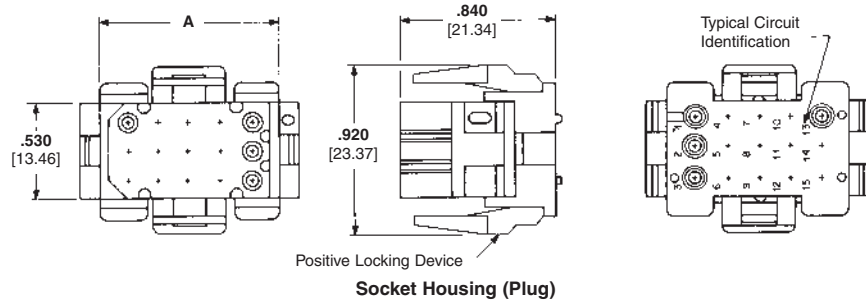
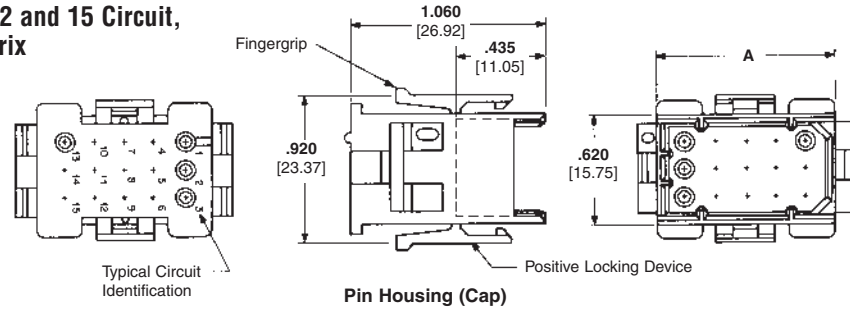

**20, 24 and 36 Circuit, Matrix**

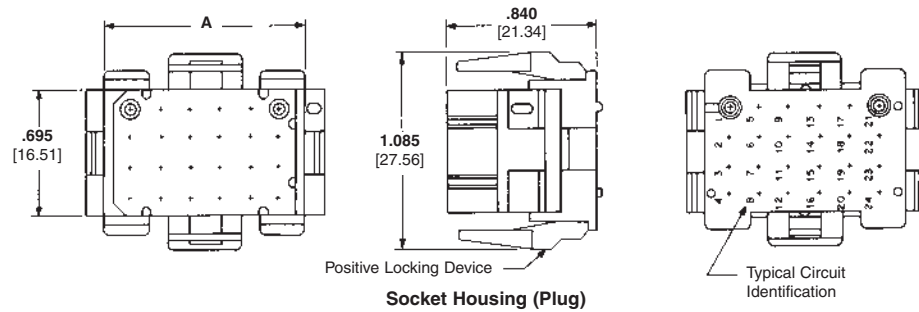
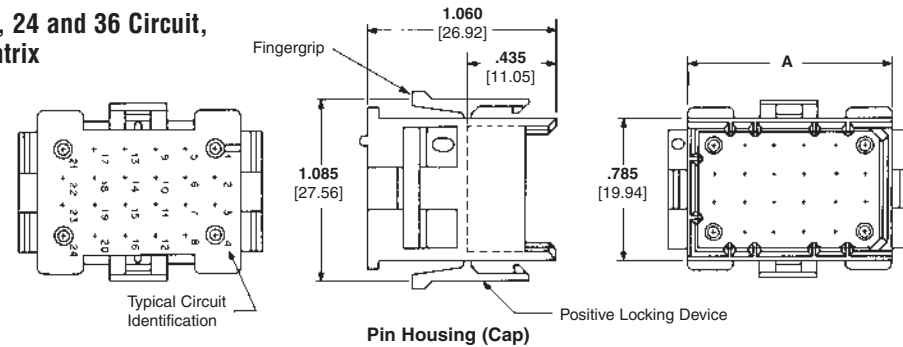

| Number of Circuits | A Dim.        | Part Numbers      |                       |
|--------------------|---------------|-------------------|-----------------------|
|                    |               | Pin Housing (Cap) | Socket Housing (Plug) |
| 9                  | .620 [15.75]  | 1-640511-0        | 1-640521-0            |
| 12                 | .785 [19.94]  | 1-640512-0        | 1-640522-0            |
| 15                 | .950 [24.13]  | 1-640513-0        | 1-640523-0            |
| 20                 | .950 [24.13]  | 1-640514-0        | 1-640524-0            |
| 24                 | 1.115 [28.32] | 1-640515-0        | 1-640525-0            |
| 36                 | 1.610 [40.89] | 1-640516-0        | 1-640526-0            |

**Note:** All part numbers are RoHS Compliant.

High Density

(MR) Miniature Rectangular Connectors .165 [4.20] Centerline

**(MR) Miniature Rectangular Connectors** (Continued)

**Recommended Panel  
Cutouts for Pin and Socket  
Housings**

**Related Product Data**

**Product Specification**

108-1022 (MR) Miniature Rectangular  
Connectors

**Housings**—pages 113-114

**Technical Documents**—pages 109  
and 205-206



View is from housing entry side

Panel Thickness .068 [1.75] Max.

| Number of<br>Circuits | Panel Cutout Dimensions |               |               |               |                |                |
|-----------------------|-------------------------|---------------|---------------|---------------|----------------|----------------|
|                       | A                       | B             | C             | D             | E              | F              |
| 2                     | .105<br>2.67            | .220<br>5.59  | .475<br>12.07 | .630<br>16.00 | .785<br>19.94  | .430<br>10.92  |
| 3                     | .105<br>2.67            | .220<br>5.59  | .640<br>16.26 | .795<br>20.19 | .950<br>24.13  | .430<br>10.92  |
| 4                     | .157<br>3.99            | .280<br>5.28  | .475<br>12.07 | .630<br>16.00 | .785<br>19.94  | .595<br>15.11  |
| 6                     | .208<br>5.28            | .345<br>8.76  | .475<br>12.07 | .630<br>16.00 | .785<br>19.94  | .760<br>19.30  |
| 9                     | .208<br>5.28            | .345<br>8.76  | .640<br>16.26 | .795<br>20.19 | .950<br>24.13  | .760<br>19.30  |
| 12                    | .225<br>5.72            | .475<br>12.07 | .640<br>16.26 | .795<br>20.19 | .950<br>24.13  | .925<br>23.50  |
| 15                    | .308<br>7.82            | .475<br>12.07 | .640<br>16.26 | .795<br>20.19 | .950<br>24.13  | 1.090<br>27.69 |
| 20                    | .308<br>7.82            | .475<br>12.07 | .805<br>20.45 | .960<br>24.38 | 1.115<br>28.32 | 1.090<br>27.69 |
| 24                    | .390<br>9.91            | .475<br>12.07 | .805<br>20.45 | .960<br>24.38 | 1.115<br>28.32 | 1.255<br>31.88 |
| 36                    | .625<br>15.86           | .500<br>12.70 | .800<br>20.32 | .950<br>24.13 | 1.100<br>27.94 | 1.750<br>44.45 |

**Notes:**

1. When mounted in a .060 [1.52] thick panel, the cap's mating end extends .800 [20.32] beyond the panel front; wire end extends .220 [55.88] from the panel rear. Plug mating end extends .580 [14.73] beyond the panel front; wire end extends .220 [55.88] from the panel rear.
2. The panel should be punched so that the housing enters the panel in the same direction as the punch for ease of assembly.

High Density

(MR) Miniature Rectangular Connectors  
.165 [4.20] Centerline

**(MR) Miniature Rectangular Connectors (Continued)**

**Strain Reliefs**

**One Piece — Clam Shell**

(Illustrated in closed position)  
IS 408-3231

**Material**

Nylon, Natural (Color—Brick Red)

**Flammability Rating**—UL94V-0

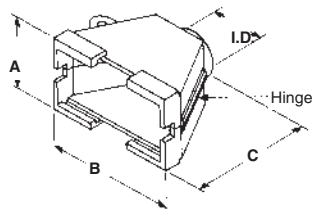

6, 9, 12, 15 and 20 Circuit

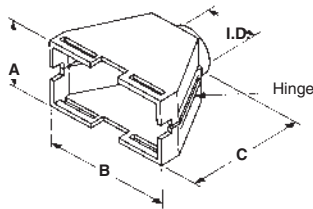

24 and 36 Circuit

| Number of Circuits | Dimensions |       |       |       | Part Numbers |
|--------------------|------------|-------|-------|-------|--------------|
|                    | I.D.       | A     | B     | C     |              |
| 6                  | .374       | .634  | .760  | 1.000 | 350373-1     |
|                    | 9.50       | 16.10 | 19.30 | 25.4  |              |
| 9                  | .420       | .800  | .760  | 1.000 | 350522-1     |
|                    | 10.67      | 20.32 | 19.30 | 25.4  |              |
| 12                 | .420       | .790  | .925  | 1.000 | 350374-1     |
|                    | 10.67      | 20.07 | 23.50 | 25.4  |              |
| 15                 | .420       | .790  | 1.090 | 1.000 | 350523-1     |
|                    | 10.67      | 20.07 | 27.69 | 25.4  |              |
| 20                 | .560       | .960  | 1.090 | 1.280 | 480634-1     |
|                    | 14.22      | 24.38 | 27.69 | 23.51 |              |
| 24                 | .560       | .900  | 1.255 | 1.280 | 350524-1     |
|                    | 14.22      | 22.86 | 31.88 | 23.51 |              |
| 36                 | .560       | .900  | 1.750 | 1.280 | 480594-1     |
|                    | 14.22      | 22.86 | 44.45 | 23.51 |              |

**Notes:**

1. These strain reliefs can be used with either pin or socket housings.
2. **Customer supplied:** One No. 6 Panhead Type B self-taping screw, 3/8 long. Plating is optional to conform to customer requirements.
3. Strain reliefs are also available in UL94V-2 nylon, black in color. To order strain reliefs in this material use the appropriate dash numbers: 1-XXXXXX-9.

**Commoning Bars**

IS 408-3231

**Material**

Brass

Stock thickness .008 [.203]

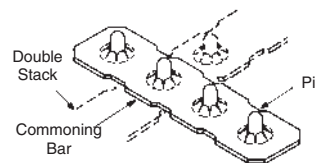
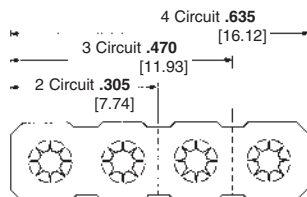

| Finish            | Part Numbers |           |           |
|-------------------|--------------|-----------|-----------|
|                   | 2 Circuit    | 3 Circuit | 4 Circuit |
| Pre-tin           | 350020-1     | 350021-1  | 350022-1  |
| Gold <sup>1</sup> | 350020-2     | 350021-2  | 350022-2  |

<sup>1</sup>Gold Finish—Plated with .000030 [.000762] min. gold over .000050 [.00127] min. nickel underplate on entire contact.

**Related Product Data**

**Housings**—pages 113-114

**Notes:**

1. Commoning bars can be used to common adjacent pin contacts in any column or row. Maximum stack per pin is two.
2. The above illustrates the proper insertion of the Commoning Bar.
3. Use the mating socket housing to assemble the Commoning Bar onto the pins.



**Commoning Bar Extraction Tool**  
Part No. 457306-1  
IS 408-3231

**Note:** All part numbers are RoHS Compliant.

High Density

(MR) Miniature Rectangular Connectors .165 [4.20] Centerline

**(MR) Miniature Rectangular Connectors (Continued)**

**PC Board Vertical  
Pin Headers**

.165 [4.19] Centerline spacing

**Material**

**Housing**—Nylon, Natural (Color—  
Brick Red)

**Flammability Rating**—UL94V-0

**Contacts**—Phosphor bronze  
Solder tail diameter .040 [1.02]

**Related Product Data**

**Product Specification**

108-1078 (MR) Miniature Rectangular  
Headers

**Dimensions A and B**—page 118

**Performance Characteristics**—  
pages 109-110

**Technical Documents**—pages 109  
and 205-206

**Mating Socket Housings**—pages  
113-114

**2 and 3 Circuit, In-Line**

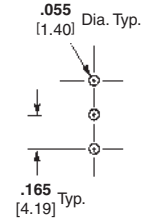

Recommended PC Board Hole Layout

**4 and 6 Circuit, Matrix**



Recommended PC Board Hole Layout

**9, 12 and 15 Circuit,  
Matrix**



Recommended PC Board Hole Layout

High Density

(MR) Miniature Rectangular Connectors  
.165 [4.20] Centerline

**(MR) Miniature Rectangular Connectors (Continued)**

**PC Board Vertical  
Pin Headers**

.165 [4.19] Centerline spacing

**Material**

**Housing**—Nylon, Natural (Color—Brick Red)

**Flammability Rating**—UL94V-0

**Contacts**—Phosphor bronze  
Solder tail diameter .040 [1.02]

**Related Product Data**

**Product Specification**

108-1078 (MR) Miniature Rectangular Headers

**Dimensions** (2 and 3 Circuit, In-Line; 4, 6, 9, 12 and 15 Circuit, Matrix)  
— page 118

**Performance Characteristics**—  
pages 109-110

**Vertical Pin Headers and  
Recommended PC Board Hole  
Layouts**—pages 117-118

**Technical Documents**—pages 109  
and 205-206

**Mating Socket Housings**—pages  
113-114

**20, 24 and 36 Circuit,  
Matrix**

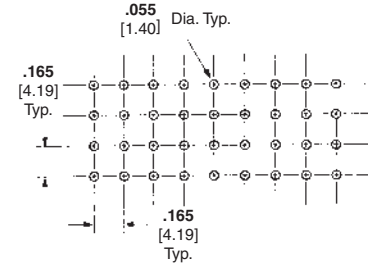
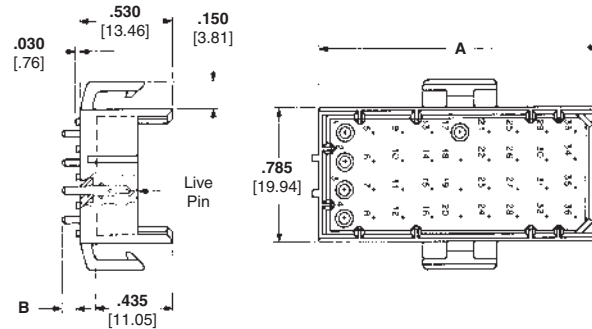

**Recommended PC Board Hole Layout**

| Number of Circuits | Board Thickness | Dimensions     |              | Header Part Numbers |                            | Mates with Socket Housing Part No. |
|--------------------|-----------------|----------------|--------------|---------------------|----------------------------|------------------------------------|
|                    |                 | A              | B            | Tin Finish          | Duplex Finish <sup>1</sup> |                                    |
| 2<br>In-Line       | .062<br>1.57    | .455<br>11.56  | .120<br>3.05 | 640497-1            | 2-640497-2                 | 1-640517-0                         |
|                    | .120<br>3.05    | .455<br>11.56  | .180<br>4.57 | 640497-3            | 2-640497-4                 |                                    |
| 3<br>In-Line       | .062<br>1.57    | .620<br>15.75  | .120<br>3.05 | 640498-1            | 2-640498-2                 | 1-640518-0                         |
|                    | .120<br>3.05    | .620<br>15.75  | .180<br>4.57 | 640498-3            | 2-640498-4                 |                                    |
| 4                  | .062<br>1.57    | .455<br>11.56  | .120<br>3.05 | 640499-1            | 2-640499-2                 | 1-640519-0                         |
|                    | .120<br>3.05    | .455<br>11.56  | .180<br>4.57 | 640499-3            | 2-640499-4                 |                                    |
| 6                  | .062<br>1.57    | .620<br>15.75  | .120<br>3.05 | 640500-1            | 2-640500-2                 | 1-640520-0                         |
|                    | .120<br>3.05    | .620<br>15.75  | .180<br>4.57 | 640500-3            | 2-640500-4                 |                                    |
| 9                  | .062<br>1.57    | .620<br>15.75  | .120<br>3.05 | 640501-1            | 2-640501-2                 | 1-640521-0                         |
|                    | .120<br>3.05    | .620<br>15.75  | .180<br>4.57 | 640501-3            | 2-640501-4                 |                                    |
| 12                 | .062<br>1.57    | .785<br>19.94  | .120<br>3.05 | 640502-1            | 2-640502-2                 | 1-640522-0                         |
|                    | .120<br>3.05    | .785<br>19.94  | .180<br>4.57 | 640502-3            | 2-640502-4                 |                                    |
| 15                 | .062<br>1.57    | .950<br>24.13  | .120<br>3.05 | 640503-1            | 2-640503-2                 | 1-640523-0                         |
|                    | .120<br>3.05    | .950<br>24.13  | .180<br>4.57 | 640503-3            | 2-640503-4                 |                                    |
| 20                 | .062<br>1.57    | .950<br>24.13  | .120<br>3.05 | 640504-1            | 2-640504-2                 | 1-640524-0                         |
|                    | .120<br>3.05    | .950<br>24.13  | .180<br>4.57 | 640504-3            | 2-640504-4                 |                                    |
| 24                 | .062<br>1.57    | 1.115<br>28.32 | .120<br>3.05 | 640505-1            | 2-640505-2                 | 1-640525-0                         |
|                    | .120<br>3.05    | 1.115<br>28.32 | .180<br>4.57 | 640505-3            | 2-640505-4                 |                                    |
| 36                 | .062<br>1.57    | 1.610<br>40.89 | .120<br>3.05 | 640506-1            | 2-640506-2                 | 1-640526-0                         |
|                    | .120<br>3.05    | 1.610<br>40.89 | .180<br>4.57 | 640506-3            | 2-640506-4                 |                                    |

<sup>1</sup>Duplex Finish—Plated with .000030 [.000762] min. gold in mating area, matte tin on solder tail end over .000050 [.00127] min. nickel underplate on entire contact.

**Note:** All part numbers are RoHS Compliant.

High Density

(MR) Miniature Rectangular Connectors  
.165 [4.20] Centerline

## VAL-U-LOK Connector System (Wire-to-Wire, Wire-to-Board and Wire-to-Panel)

### Product Facts

- Low cost, wire-to-wire, wire-to-board and wire-to-panel connectors with 4.2 mm centerline
- Easy mate and unmate with positive latch design
- Single row, 3-5 positions: receptacles, panel mount or free-hanging plugs
- Double row, 2-24 positions (even only): receptacles, panel mount or free-hanging plugs, and vertical or right-angle pin headers
- Available in UL 94V-2 or UL 94V-0 flammability rated nylon
- Products are lead free to help promote a cleaner environment
- Intermateable and interchangeable with Molex Mini-Fit, Jr. and intermateable AMP-DUAC connectors
- Recognized under the Component Program of Underwriters Laboratories Inc., File No. E28476 
- Certified by Canadian Standards Association, File No. 208567 
- Tyco Electronics Design For Environment (DFE) Standard 230-5



High Density

VAL-U-LOK Connector System  
.165 [4.20] Centerline

### Performance Characteristics

#### Electrical

- Voltage**—600 VAC
- Current**—9 amps max. in 2-position applications
- Dielectric Withstanding Voltage**—1500 VAC min.
- Insulation Resistance**—1000 megohms min.
- Operating Temperature**—-40°C to +105°C [-40°F to +221°F]

#### Mechanical

- Connector Mating**—1.55 lb. [6.90 N] max. per circuit
- Connector Unmating**—.11 lb. [.49 N] min. per circuit
- Contact Retention**—4.88 lb. [21.71 N] min. per contact
- Durability**—30 cycles, mating and unmating

### Material and Finish

- Housings**—Nylon, UL 94V-2 and UL 94V-0
- Contacts**—Brass or Phos. Bronze with tin plating (Lead-Free) or gold plating

### Technical Documents

- Design Objective** 108-2112
- Application Specification** 114-13172
- Engineering Test Report** 502-1204

### Applications

- Computer motherboards/power supplies
- Harness assemblies used in the Vending, Gaming and Appliance industries
- Car alarm systems
- Heating systems

Molex and Mini-Fit are trademarks of Molex Incorporated.

**VAL-U-LOK Connector System**  
**(Wire-to-Wire, Wire-to-Board and Wire-to-Panel)** (Continued)

**Contacts**

| Wire Range (AWG) | Insulation Range             | Material & Finish   | Pin        |             | Socket     |             | Applicator Part Number <sup>1</sup> | PRO-CRIMPER III Hand Tool Part Number |
|------------------|------------------------------|---------------------|------------|-------------|------------|-------------|-------------------------------------|---------------------------------------|
|                  |                              |                     | Strip Form | Loose Piece | Strip Form | Loose Piece |                                     |                                       |
| 26-22            | .047 - .069<br>[1.2 - 1.75]  | Brass, Pre-Tin      | 794957-1   | 1586316-1   | 794958-1   | 1586317-1   | 1385448-X                           | 91387-1                               |
|                  |                              | Phos. Brz., Pre-Tin | 794957-3   | 1586316-3   | 794958-3   | 1586317-3   |                                     |                                       |
|                  |                              | Brass, Gold         | 794957-2   | 1586316-2   | 794958-2   | 1586317-2   |                                     |                                       |
|                  |                              | Phos. Brz., Gold    | 794957-4   | 1586316-4   | 794958-4   | 1586317-4   |                                     |                                       |
| 22-18            | .060 - .122<br>[1.50 - 3.10] | Brass, Pre-Tin      | 794955-1   | 1586314-1   | 794956-1   | 1586315-1   | 1852668-X                           | 91388-1                               |
|                  |                              | Phos. Brz., Pre-Tin | 794955-3   | 1586314-3   | 794956-3   | 1586315-3   |                                     |                                       |
|                  |                              | Brass, Gold         | 794955-2   | 1586314-2   | 794956-2   | 1586315-2   |                                     |                                       |
|                  |                              | Phos. Brz., Gold    | 794955-4   | 1586314-4   | 794956-4   | 1586315-4   |                                     |                                       |
| 16               | .071 - .122<br>[1.8 - 3.10]  | Brass, Pre-Tin      | 1586054-1  | 1586840-1   | 1586055-1  | 1586841-1   | 1852294-X                           | 1976444-1                             |
|                  |                              | Phos. Brz., Pre-Tin | 1586054-3  | 1586840-3   | 1586055-3  | 1586841-2   |                                     |                                       |
|                  |                              | Brass, Gold         | 1586054-2  | 1586840-2   | 1586055-2  | 1586841-3   |                                     |                                       |
|                  |                              | Phos. Brz., Gold    | 1586054-4  | 1586840-4   | 1586055-4  | 1586841-4   |                                     |                                       |

Extraction Tool Part Number 1586343-1

<sup>1</sup> For applicator and machine part numbers, contact Technical Support.

**Pin — (used in Plug Housing)**



**Socket — (used in Receptacle Housing)**



VAL-U-LOK Connector System  
High Density  
.165 [4.20] Centerline



**VAL-U-LOK Connector System**  
**(Wire-to-Wire, Wire-to-Board and Wire-to-Panel)** (Continued)

**Housings — Single Row**

| No. of Positions | UL 94V-2 Housings |                   |                    | UL 94V-0 Housings |                   |                    |
|------------------|-------------------|-------------------|--------------------|-------------------|-------------------|--------------------|
|                  | Panel Mount Plug  | Free-Hanging Plug | Receptacle Housing | Panel Mount Plug  | Free-Hanging Plug | Receptacle Housing |
| 3*               | 1586101-3         | 1586103-3         | 1586105-3          | 1586102-3         | 1586104-3         | 1586106-3          |
| 4                | 1586022-4         | 1586024-4         | 1586026-4          | 1586023-4         | 1586025-4         | 1586027-4          |
| 5                | 1586022-5         | 1586024-5         | 1586026-5          | 1586023-5         | 1586025-5         | 1586027-5          |

\*Note: 3 position housings are First Mate/Last Break.

Note: All part numbers are RoHS Compliant.

**Panel Mount Plug Housing**



**Receptacle Housing**

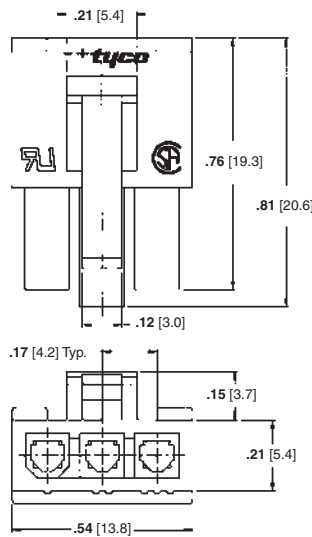

**Free-Hanging Plug Housing**



**Headers — Single Row, Vertical**

| No. of | UL 94V-2 Housings |                     | UL 94V-0 Housings |
|--------|-------------------|---------------------|-------------------|
|        | With Drain Holes  | Without Drain Holes | With Drain Holes  |
| 3*     | 2029054-3         | 2029058-3           | 2029056-3         |
| 4      | 2029054-4         | 2029058-4           | 2029056-4         |
| 5      | 2029054-5         | 2029058-5           | 2029056-5         |

\*Note: 3 position housings are First Mate/Last Break.

Note: All part numbers are RoHS Compliant.



**VAL-U-LOK Connector System**  
**(Wire-to-Wire, Wire-to-Board and Wire-to-Panel)** (Continued)

**Housings — Double Row**

| No. of Positions | UL 94V-2 Housings |                   |                    | UL 94V-0 Housings |                   |                    |
|------------------|-------------------|-------------------|--------------------|-------------------|-------------------|--------------------|
|                  | Panel Mount Plug  | Free-Hanging Plug | Receptacle Housing | Panel Mount Plug  | Free-Hanging Plug | Receptacle Housing |
| 2                | 794953-2          | 1586000-2         | 794954-2           | 1586018-2         | 1586017-2         | 1586019-2          |
| 4                | 794953-4          | 1586000-4         | 794954-4           | 1586018-4         | 1586017-4         | 1586019-4          |
| 6                | 794953-6          | 1586000-6         | 794954-6           | 1586018-6         | 1586017-6         | 1586019-6          |
| 8                | 794953-8          | 1586000-8         | 794954-8           | 1586018-8         | 1586017-8         | 1586019-8          |
| 10               | 1-794953-0        | 1-1586000-0       | 1-794954-0         | 1-1586018-0       | 1-1586017-0       | 1-1586019-0        |
| 12               | 1-794953-2        | 1-1586000-2       | 1-794954-2         | 1-1586018-2       | 1-1586017-2       | 1-1586019-2        |
| 14               | 1-794953-4        | 1-1586000-4       | 1-794954-4         | 1-1586018-4       | 1-1586017-4       | 1-1586019-4        |
| 16               | 1-794953-6        | 1-1586000-6       | 1-794954-6         | 1-1586018-6       | 1-1586017-6       | 1-1586019-6        |
| 18               | 1-794953-8        | 1-1586000-8       | 1-794954-8         | 1-1586018-8       | 1-1586017-8       | 1-1586019-8        |
| 20               | 2-794953-0        | 2-1586000-0       | 2-794954-0         | 2-1586018-0       | 2-1586017-0       | 2-1586019-0        |
| 22               | 2-794953-2        | 2-1586000-2       | 2-794954-2         | 2-1586018-2       | 2-1586017-2       | 2-1586019-2        |
| 24               | 2-794953-4        | 2-1586000-4       | 2-794954-4         | 2-1586018-4       | 2-1586017-4       | 2-1586019-4        |

Note: Plug housings accept pin contacts and receptacle housings accept socket contacts on page 114.

Note: All part numbers are RoHS Compliant.



**Housings — Colored**

| Color | No. of Positions | UL 94V-2 Housings |                   |                    | UL 94V-0 Housings |                   |                    |
|-------|------------------|-------------------|-------------------|--------------------|-------------------|-------------------|--------------------|
|       |                  | Panel Mount Plug  | Free-Hanging Plug | Receptacle Housing | Panel Mount Plug  | Free-Hanging Plug | Receptacle Housing |
| Black | 2-24             | X-2029088-X       | X-2029027-X       | X-1586075-X        | X-2029035-X       | X-2029028-X       | X-2029029-X        |
| Red   | 4-24             | X-2029089-X       | X-2029090-X       | X-2029091-X        | X-2029092-X       | X-2029093-X       | X-2029094-X        |
| Blue  | 6-24             | X-2029095-X       | X-2029096-X       | X-2029097-X        | X-2029098-X       | X-2029099-X       | X-2029100-X        |

Note: Plug housings accept pin contacts and receptacle housings accept socket contacts on page 114.

Note: All part numbers are RoHS Compliant.

VAL-U-LOK Connector System  
High Density  
.165 [4.20] Centerline

**VAL-U-LOK Connector System**  
(Wire-to-Wire, Wire-to-Board and Wire-to-Panel) (Continued)

**Pin Headers**

| No. of Positions | UL 94V-2 Pin Headers |             |             |             | UL 94V-0 Pin Headers |             |             |             |
|------------------|----------------------|-------------|-------------|-------------|----------------------|-------------|-------------|-------------|
|                  | Vertical             |             | Right-Angle |             | Vertical             |             | Right-Angle |             |
|                  | w/o Pegs             | w/Pegs      | w/o Pegs    | Screw Mount | w/o Pegs             | w/Pegs      | w/o Pegs    | Screw Mount |
| 2                | 1586037-2            | 1586039-2   | 1586041-2   | 1586043-2   | 1586038-2            | 1586040-2   | 1586042-2   | 1586044-2   |
| 4                | 1586037-4            | 1586039-4   | 1586041-4   | 1586043-4   | 1586038-4            | 1586040-4   | 1586042-4   | 1586044-4   |
| 6                | 1586037-6            | 1586039-6   | 1586041-6   | 1586043-6   | 1586038-6            | 1586040-6   | 1586042-6   | 1586044-6   |
| 8                | 1586037-8            | 1586039-8   | 1586041-8   | 1586043-8   | 1586038-8            | 1586040-8   | 1586042-8   | 1586044-8   |
| 10               | 1-1586037-0          | 1-1586039-0 | 1-1586041-0 | 1-1586043-0 | 1-1586038-0          | 1-1586040-0 | 1-1586042-0 | 1-1586044-0 |
| 12               | 1-1586037-2          | 1-1586039-2 | 1-1586041-2 | 1-1586043-2 | 1-1586038-2          | 1-1586040-2 | 1-1586042-2 | 1-1586044-2 |
| 14               | 1-1586037-4          | 1-1586039-4 | 1-1586041-4 | 1-1586043-4 | 1-1586038-4          | 1-1586040-4 | 1-1586042-4 | 1-1586044-4 |
| 16               | 1-1586037-6          | 1-1586039-6 | 1-1586041-6 | 1-1586043-6 | 1-1586038-6          | 1-1586040-6 | 1-1586042-6 | 1-1586044-6 |
| 18               | 1-1586037-8          | 1-1586039-8 | 1-1586041-8 | 1-1586043-8 | 1-1586038-8          | 1-1586040-8 | 1-1586042-8 | 1-1586044-8 |
| 20               | 2-1586037-0          | 2-1586039-0 | 2-1586041-0 | 2-1586043-0 | 2-1586038-0          | 2-1586040-0 | 2-1586042-0 | 2-1586044-0 |
| 22               | 2-1586037-2          | 2-1586039-2 | 2-1586041-2 | 2-1586043-2 | 2-1586038-2          | 2-1586040-2 | 2-1586042-2 | 2-1586044-2 |
| 24               | 2-1586037-4          | 2-1586039-4 | 2-1586041-4 | 2-1586043-4 | 2-1586038-4          | 2-1586040-4 | 2-1586042-4 | 2-1586044-4 |

**Note:** All Headers have Brass, Tin-Plated contacts.

**Note:** All part numbers are RoHS Compliant.

**Vertical Pin Headers** (Part No. 1586037 shown w/o pegs)



**PCB Layout: Component Side (shown with pegs)**  
Recommended Board Thickness .070 [1.78]

**Right-Angle Pin Headers** (Part No. 1586043 Screw Mount)

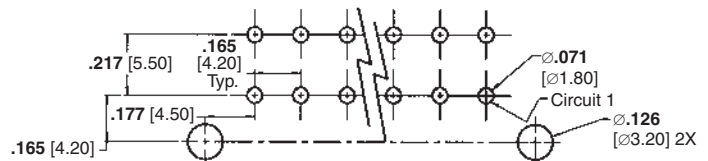

**PCB Layout: Component Side (screw mount shown)**  
Recommended Board Thickness .063 [1.60]

High Density

VAL-U-LOK Connector System  
.165 [4.20] Centerline

**VAL-U-LOK Connector System**  
**(Wire-to-Wire, Wire-to-Board and Wire-to-Panel)** (Continued)

**Blindmate Headers**

| No. of Pos. | Dimensions     |                |                |                |                | UL 94V-2 Housings |                     | UL 94V-0 Housings |                     |
|-------------|----------------|----------------|----------------|----------------|----------------|-------------------|---------------------|-------------------|---------------------|
|             | A              | B              | C              | D              | E              | With Drain Holes  | Without Drain Holes | With Drain Holes  | Without Drain Holes |
| 2           | —              | 5.4<br>[0.21]  | 9.4<br>[0.37]  | 10.8<br>[0.43] | 13.2<br>[0.52] | 1586585-2         | 1586586-2           | 1586587-2         | 1586588-2           |
| 4           | 4.2<br>[0.17]  | 9.6<br>[0.38]  | 13.6<br>[0.54] | 15.0<br>[0.59] | 17.4<br>[0.69] | 1586585-4         | 1586586-4           | 1586587-4         | 1586588-4           |
| 6           | 8.4<br>[0.33]  | 13.8<br>[0.54] | 17.8<br>[0.70] | 19.2<br>[0.76] | 21.6<br>[0.85] | 1586585-6         | 1586586-6           | 1586587-6         | 1586588-6           |
| 8           | 12.6<br>[0.50] | 18.0<br>[0.71] | 22.0<br>[0.87] | 23.4<br>[0.92] | 25.8<br>[1.02] | 1586585-8         | 1586586-8           | 1586587-8         | 1586588-8           |
| 10          | 16.8<br>[0.66] | 22.2<br>[0.87] | 26.2<br>[1.03] | 27.6<br>[1.09] | 30.0<br>[1.18] | 1-1586585-0       | 1-1586586-0         | 1-1586587-0       | 1-1586588-0         |
| 12          | 21.0<br>[0.83] | 26.4<br>[1.04] | 30.4<br>[1.20] | 31.8<br>[1.25] | 34.2<br>[1.35] | 1-1586585-2       | 1-1586586-2         | 1-1586587-2       | 1-1586588-2         |
| 14          | 25.2<br>[0.99] | 30.6<br>[1.20] | 34.6<br>[1.36] | 36.0<br>[1.42] | 38.4<br>[1.51] | 1-1586585-4       | 1-1586586-4         | 1-1586587-4       | 1-1586588-4         |
| 16          | 29.4<br>[1.58] | 34.8<br>[1.37] | 38.8<br>[1.53] | 40.2<br>[1.58] | 42.6<br>[1.69] | 1-1586585-6       | 1-1586586-6         | 1-1586587-6       | 1-1586588-6         |
| 18          | 33.6<br>[1.32] | 39.0<br>[1.54] | 43.0<br>[1.69] | 44.4<br>[1.75] | 46.8<br>[1.84] | 1-1586585-8       | 1-1586586-8         | 1-1586587-8       | 1-1586588-8         |
| 20          | 37.8<br>[1.49] | 43.2<br>[1.70] | 47.2<br>[1.86] | 48.6<br>[1.91] | 51.0<br>[2.01] | 2-1586585-0       | 2-1586586-0         | 2-1586587-0       | 2-1586588-0         |
| 22          | 42.0<br>[1.65] | 47.4<br>[1.87] | 51.4<br>[2.02] | 52.0<br>[2.08] | 55.2<br>[2.17] | 2-1586585-2       | 2-1586586-2         | 2-1586587-2       | 2-1586588-2         |
| 24          | 46.2<br>[1.82] | 51.6<br>[2.03] | 55.6<br>[2.19] | 57.0<br>[2.24] | 59.4<br>[2.32] | 2-1586585-4       | 2-1586586-4         | 2-1586587-4       | 2-1586588-4         |

Note: All part numbers are RoHS Compliant.

VAL-U-LOK Connector System  
High Density  
.165 [4.20] Centerline



## AMP-DUAC Connectors

### Product Facts

- Wire-to-board and wire-to-wire connector system
- Free-hanging or panel mount plug housings
- Vertical header with or without mounting pegs and with or without drain holes
- Selective loading available on vertical headers
- 4.2 mm x 4.2 mm centerline
- Male and female contacts designed for 26-22 AWG and 22-18 AWG wire
- Receptacle housings accept female contacts with less orientation than competitive product
- Right-angle headers
- Designed for power applications
- Positive latch feature helps prevent disconnection
- AMP-DUAC (dual action) receptacle contacts
- Anti-stubbing contact design
- Polarized housings
- Intermateable with Molex Mini-Fit Jr. connectors
- Recognized under Component Program of Underwriters Laboratories Inc., File No. E28476
- Certified by Canadian Standards Association, File No. LR7189



AMP-DUAC Connectors, for power or signal applications, belong to the broad family of Tyco Electronics Soft Shell connectors.

The dual action design of the female receptacle contact provides for low insertion force, yet maintains high-performance current capacity. To help meet your production requirements, semiautomatic bench machines and hand tools are available for strip and loose piece contacts, respectively.

High density, 4.2 mm x 4.2 mm [.165 x .165] centerline, dual-row receptacle housings mate with plug housings (free-hanging or panel mount) or pc board headers (vertical or right-angle). Selective contact loading is available for vertical headers.

All housings are polarized for easier mating and locking latches help maintain reliable connections.

AMP-DUAC wire-to-board, wire-to-panel, and wire-to-wire connectors are intermateable with Molex Mini-Fit Jr. series connectors.

### Technical Documents

- Product Specifications**  
108-1699—Headers  
108-19099—Receptacles
- Application Specification**  
114-19048—Use of Receptacles
- Qualification Test Report**  
501-434  
501-576

### Performance Data

- Voltage Rating**—600 VAC
- Current Rating**—9 amps maximum in 2 position applications
- Low Level Resistance**—10 megohms max.
- Dielectric Withstanding Voltage**—1500 VAC/min.
- Insulation Resistance**—1000 megohms minimum
- Operating Temperature**—-55°C to +105°C [-67°F to +221°F]

### Need more information?

Call Technical Support.

Technical Support is staffed with specialists well versed in Tyco Electronics products. They can provide you with:

- Technical support
- Catalogs
- Technical Documents
- Product Samples
- Tyco Electronics Authorized Distributor Locations

**AMP-DUAC Connectors (Continued)**

**Receptacle Housings**

**2-24 Position Housings**

Accept female contacts.

**Material**

**Housings**—Nylon  
UL 94V-2, Natural color  
UL 94V-0, White color

**Related Product Data**

**Mate with**—Vertical headers (pages 128-133), right-angle headers (page 128) and plug housings (page 127).

**Contacts**—See below.

**Strain Relief**—See below and page 127.

**Technical Documents**—pages 125 and 205-206

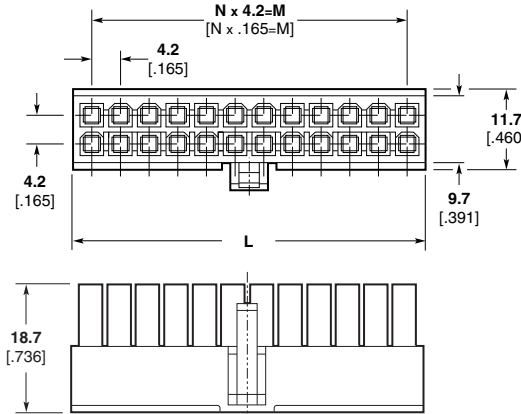

| Number of Positions | Dimensions    |               |    | Part Number      |                |
|---------------------|---------------|---------------|----|------------------|----------------|
|                     | L             | M             | N  | UL 94V-2 Natural | UL 94V-0 White |
| 2                   | 5.5<br>.216   | —             | 1  | 106527-2         | 794657-2       |
| 4                   | 9.7<br>.381   | 4.2<br>.165   | 1  | 106527-4         | 794657-4       |
| 6                   | 13.9<br>.547  | 8.4<br>.330   | 2  | 106527-6         | 794657-6       |
| 8                   | 18.1<br>.712  | 12.6<br>.496  | 3  | 106527-8         | 794657-8       |
| 10                  | 22.3<br>.877  | 16.8<br>.661  | 4  | 1-106527-0       | 1-794657-0     |
| 12                  | 26.5<br>1.043 | 21.0<br>.826  | 5  | 1-106527-2       | 1-794657-2     |
| 14                  | 30.7<br>1.208 | 25.2<br>.992  | 6  | 1-106527-4       | 1-794657-4     |
| 16                  | 34.9<br>1.374 | 29.4<br>1.157 | 7  | 1-106527-6       | 1-794657-6     |
| 18                  | 39.1<br>1.539 | 33.6<br>1.322 | 8  | 1-106527-8       | 1-794657-8     |
| 20                  | 43.3<br>1.704 | 37.8<br>1.488 | 9  | 2-106527-0       | 2-794657-0     |
| 22                  | 47.5<br>1.870 | 42.0<br>1.653 | 10 | 2-106527-2       | 2-794657-2     |
| 24                  | 51.7<br>2.035 | 46.2<br>1.818 | 11 | 2-106527-4       | 2-794657-4     |



**Strain Relief, 6 Position  
Part Number 1375618-1**

Used with plug or receptacle housings.

**Wire Bundle Range**—4.19-5.59  
[.165-.220]

**Material**—Nylon,  
UL 94V-2, Natural color

**Female Contacts**

Used in receptacle housings.

**Material**—Phos. Bronze

**Application Tooling**—See chart and pages 207-210



**Technical Documents**

**Product Specifications**  
108-1699 AMP-DUAC Header  
108-19099 AMP-DUAC Receptacle

**Application Specification**  
114-19048 AMP-DUAC Receptacle Contact

| Wire Size Range AWG [mm <sup>2</sup> ] | Ins. Dia. Range           | Plating | Part Number |             | Applicator Part Number          |  |                                   |
|--|---------------------------|---------|-------------|-------------|---------------------------------|--|-----------------------------------|
|  |                           |         | Strip Form  | Loose Piece | for AMP-O-LECTRIC Bench Machine | for AMP-O-MATIC Stripper/Crimper Machine | CERTI-CRIMP Hand Tool Part Number |
| 22-18<br>[.3-.8]                       | 1.5-2.4<br>.059-.094      | Tin     | 106529-2    | 1-106529-2  | 680308-□*                       | 567959-1                                 | 734202-2                          |
|  |                           | Gold    | 1-794138-3  | 1-794141-3  |                                 |  |                                   |
| 26-22<br>[.12-.3]                      | 1.3-1.75<br>.047-.069     | Tin     | 106528-2    | 1-106528-2  | 680307-□*                       | 567960-1                                 | —                                 |
|  |                           | Gold    | 1-794139-3  | 1-794142-3  |                                 |  |                                   |
| 2@18 or 16<br>[.8-.9] [1.29]           | 3.3 Total<br>Max.<br>.130 | Tin     | 794418-1    | 794421-1    | 680350-□*                       | —  | 90714-1                           |
|  |                           | Gold    | 1-794140-3  | 1-794143-3  |                                 |  |                                   |

Extraction Tool Part Number 188688-1

\*Part Number suffix “-2” indicates Applicator for Model K Machine and “-3” for Model G Machine.

**Note: All part numbers are RoHS Compliant.**

High Density

AMP-DUAC Connectors  
.165 [4.20] Centerline

**AMP-DUAC Connectors (Continued)**

**Plug Housings**

**2-24 Position Housings**

Accept male contacts.

**Material**

**Housings**—Nylon  
UL 94V-2, Natural color  
UL 94V-0, White color

**Related Product Data**

**Mate with**—Receptacle housings (page 126)

**Contacts**—See below.

**Strain Relief**—See below.

**Technical Documents**—pages 125 and 205-206



**Recommended Cutout for 2.00 [.079] Max. Thick Panel**

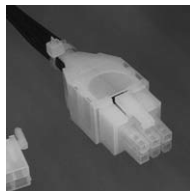
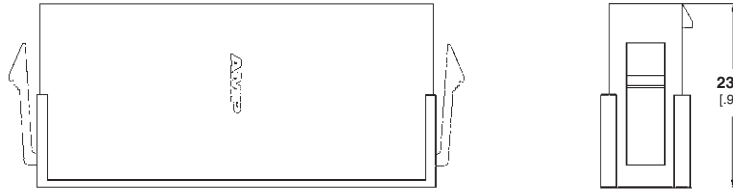

**Strain Relief, 6 Position Part Number 1375618-1**

Used with plug or receptacle housings.

**Wire Bundle Range**—4.19-5.59 [.165-.220]

**Material**—Nylon,  
UL 94V-2, Natural color

| Number of Positions | Dimensions    |               | Part Number       |             |                 |             |
|---------------------|---------------|---------------|-------------------|-------------|-----------------|-------------|
|                     | L             | M             | UL 94V-2, Natural |             | UL 94V-0, White |             |
|                     |               |               | Free-Hanging      | Panel Mount | Free-Hanging    | Panel Mount |
| 2                   | 5.4<br>.213   | 10.8<br>.425  | 794542-2          | 794550-2    | *794594-2       | *794598-2   |
| 4                   | 9.6<br>.378   | 15.0<br>.591  | 794542-4          | 794550-4    | *794594-4       | *794598-4   |
| 6                   | 13.8<br>.543  | 19.2<br>.756  | 794542-6          | 794550-6    | *794594-6       | *794598-6   |
| 8                   | 18.0<br>.709  | 23.4<br>.921  | 794542-8          | 794550-8    | *794594-8       | *794598-8   |
| 10                  | 22.2<br>.874  | 27.6<br>1.087 | 1-794542-0        | 1-794550-0  | *1-794594-0     | *1-794598-0 |
| 12                  | 26.4<br>1.039 | 31.8<br>1.252 | 1-794542-2        | 1-794550-2  | *1-794594-2     | *1-794598-2 |
| 14                  | 30.6<br>.205  | 36.0<br>1.417 | 1-794542-4        | 1-794550-4  | *1-794594-4     | *1-794598-4 |
| 16                  | 34.8<br>1.370 | 40.2<br>1.583 | 1-794542-6        | 1-794550-6  | *1-794594-6     | *1-794598-6 |
| 18                  | 39.0<br>1.535 | 44.4<br>1.748 | 1-794542-8        | 1-794550-8  | *1-794594-8     | *1-794598-8 |
| 20                  | 43.2<br>1.701 | 48.6<br>1.913 | 2-794542-0        | 2-794550-0  | *2-794594-0     | *2-794598-0 |
| 22                  | 47.4<br>1.866 | 52.8<br>2.079 | 2-794542-2        | 2-794550-2  | *2-794594-2     | *2-794598-2 |
| 24                  | 51.6<br>2.032 | 57.0<br>2.244 | 2-794542-4        | 2-794550-4  | *2-794594-4     | *2-794598-4 |

\*Call for availability.

**Male Contacts**

Used in plug housings.

**Material**—Phos. Bronze

**Application Tooling**—See chart and pages 207-210

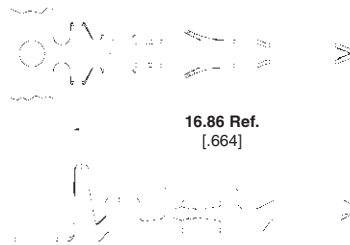

| Wire Size Range<br>AWG [mm <sup>2</sup> ] | Ins. Dia. Range       | Plating | Part Number |             | Applicator Part Number          |  |                                   |
|---|-----------------------|---------|-------------|-------------|---------------------------------|--|-----------------------------------|
|   |                       |         | Strip Form  | Loose Piece | for AMP-O-LECTRIC Bench Machine | for AMP-O-MATIC Stripper/Crimper Machine | CERTI-CRIMP Hand Tool Part Number |
| 22-18<br>[.3-.8]                          | 1.5-2.4<br>.059-.094  | Tin     | 794576-1    | 794577-1    | 680308-□*                       | 567959-1                                 | 734202-2                          |
|   |                       | Gold    | 794576-4    | —           |                                 |  |                                   |
| 26-22<br>[.12-.3]                         | 1.3-1.75<br>.047-.069 | Tin     | 794578-1    | 794579-1    | 680307-□*                       | 567960-1                                 | —                                 |
|   |                       | Gold    | 794578-4    | —           |                                 |  |                                   |

\*Part Number suffix “-2” indicates Applicator for Model K Machine and “-3” for Model G Machine.

**Note: All part numbers are RoHS Compliant.**

**AMP-DUAC Connectors (Continued)**

**Vertical Header Assemblies**

**2, 4 and 6 Position,  
with and without Pegs and  
with and without Drain  
Holes**

**Material and Finish**

**Housing**—Nylon  
UL 94V-2, Natural color  
UL 94V-0, White color

**Contacts**—0.25 [.010] thick copper alloy

**Related Product Data**

**Mate with**—Receptacle housings (page 126).

**Technical Documents**—pages 125 and 205-206



**Recommended PC Board Layout**



| Number of Positions | PCB Pegs | Drain Holes | Plating | Part Number       |                 |
|---------------------|----------|-------------|---------|-------------------|-----------------|
|                     |          |             |         | UL 94V-2, Natural | UL 94V-0, White |
| 2                   | N        | N           | Tin     | 1586491-2         | 1586495-2       |
|                     | N        | N           | 30 Gold | 1586492-2         | 1586496-2       |
|                     | Y        | N           | Tin     | 1586489-2         | 1586493-2       |
|                     | Y        | N           | 30 Gold | 1586490-2         | 1586494-2       |
|                     | N        | Y           | Tin     | 1-794349-1        | 1-794543-1      |
|                     | N        | Y           | 30 Gold | 1-794349-2        | 1-794543-2      |
|                     | Y        | Y           | Tin     | 1-794302-1        | 1-794540-1      |
|                     | Y        | Y           | 30 Gold | 1-794302-2        | 1-794540-2      |
| 4                   | Y        | N           | Tin     | 1586489-4         | 1586493-4       |
|                     | Y        | N           | 30 Gold | 1586490-4         | 1586494-4       |
|                     | N        | N           | Tin     | 1586491-4         | 1586495-4       |
|                     | N        | N           | 30 Gold | 1586492-4         | 1586496-4       |
|                     | Y        | Y           | Tin     | 1-794303-1        | 1-794466-1      |
|                     | Y        | Y           | 30 Gold | 1-794303-2        | 1-794466-2      |
|                     | N        | Y           | Tin     | 1-794350-1        | 1-794484-1      |
|                     | N        | Y           | 30 Gold | 1-794350-2        | 1-794484-2      |
| 6                   | Y        | Y           | Tin     | 1-794304-1        | 1-794467-1      |
|                     | Y        | Y           | 30 Gold | 1-794304-2        | 1-794467-2      |
|                     | N        | Y           | Tin     | 1-794351-1        | 1-794485-1      |
|                     | N        | Y           | 30 Gold | 1-794351-2        | 1-794485-2      |
|                     | Y        | N           | Tin     | 1586489-6         | 1586493-6       |
|                     | Y        | N           | 30 Gold | 1586490-6         | 1586494-6       |
|                     | N        | N           | Tin     | 1586491-6         | 1586495-6       |
|                     | N        | N           | 30 Gold | 1586492-6         | 1586496-6       |

**Note:** All part numbers are RoHS Compliant.

High Density

AMP-DUAC Connectors  
.165 [4.20] Centerline



**AMP-DUAC Connectors (Continued)**

**Vertical Header Assemblies**  
(Continued)

**8 and 10 Position,  
with and without Pegs and  
with and without Drain  
Holes**

**Material and Finish**

**Housing**—Nylon  
UL 94V-2, Natural color  
UL 94V-0, White color

**Contacts**—0.25 [.010] thick copper alloy

**Related Product Data**

**Mate with**—Receptacle housings (page 126).

**Technical Documents**—pages 125 and 205-206



**Recommended PC Board Layout**

| Number of Positions | PCB Pegs | Drain Holes | Plating | Part Number       |                 |
|---------------------|----------|-------------|---------|-------------------|-----------------|
|                     |          |             |         | UL 94V-2, Natural | UL 94V-0, White |
| 8                   | Y        | N           | Tin     | 1586489-8         | 1586493-8       |
|                     | Y        | N           | 30 Gold | 1586490-8         | 1586494-8       |
|                     | N        | N           | Tin     | 1586491-8         | 1586495-8       |
|                     | N        | N           | 30 Gold | 1586492-8         | 1586496-8       |
|                     | Y        | Y           | Tin     | 1-794305-1        | 1-794468-1      |
|                     | Y        | Y           | 30 Gold | 1-794305-2        | 1-794468-2      |
|                     | N        | Y           | Tin     | 1-794352-1        | 1-794486-1      |
|                     | N        | Y           | 30 Gold | 1-794352-2        | 1-794486-2      |
| 10                  | Y        | N           | Tin     | 1-1586489-0       | 1-1586493-0     |
|                     | Y        | N           | 30 Gold | 1-1586490-0       | 1-1586494-0     |
|                     | N        | N           | Tin     | 1-1586491-0       | 1-1586495-0     |
|                     | N        | N           | 30 Gold | 1-1586492-0       | 1-1586496-0     |
|                     | Y        | Y           | Tin     | 1-794306-1        | 1-794469-1      |
|                     | Y        | Y           | 30 Gold | 1-794306-2        | 1-794469-2      |
|                     | N        | Y           | Tin     | 1-794353-1        | 1-794487-1      |
|                     | N        | Y           | 30 Gold | 1-794353-2        | 1-794487-2      |

**Note:** All part numbers are RoHS Compliant.

**AMP-DUAC Connectors (Continued)**

**Vertical Header Assemblies**  
(Continued)

**12 Position,  
with and without Pegs and  
with and without Drain  
Holes**

**Material and Finish**

**Housing**—Nylon  
UL 94V-2, Natural color  
UL 94V-0, White color  
**Contacts**—0.25 [.010] thick copper  
alloy

**Related Product Data**

**Mate with**—Receptacle housings  
(page 126).  
**Technical Documents**—pages 125  
and 205-206

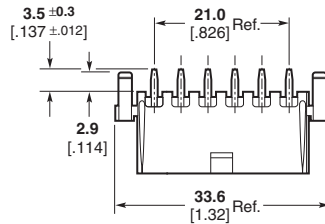

**Recommended PC Board Layout**

| Number of Positions | PCB Pegs | Drain Holes | Plating | Part Number       |                 |
|---------------------|----------|-------------|---------|-------------------|-----------------|
|                     |          |             |         | UL 94V-2, Natural | UL 94V-0, White |
| 12                  | Y        | N           | Tin     | 1-1586489-2       | 1-1586493-2     |
|                     | Y        | N           | 30 Gold | 1-1586490-2       | 1-1586494-2     |
|                     | N        | N           | Tin     | 1-1586491-2       | 1-1586495-2     |
|                     | N        | N           | 30 Gold | 1-1586492-2       | 1-1586496-2     |
|                     | Y        | Y           | Tin     | 1-794307-1        | 1-794470-1      |
|                     | Y        | Y           | 30 Gold | 1-794307-2        | 1-794470-2      |
|                     | N        | Y           | Tin     | 1-794354-1        | 1-794488-1      |
|                     | N        | Y           | 30 Gold | 1-794354-2        | 1-794488-2      |

**14 Position,  
with and without Pegs and  
with and without Drain  
Holes**

**Material and Finish**

**Housing**—Nylon  
UL 94V-2, Natural color  
UL 94V-0, White color  
**Contacts**—0.25 [.010] thick copper  
alloy

**Related Product Data**

**Mate with**—Receptacle housings  
(page 126).  
**Technical Documents**—pages 125  
and 205-206

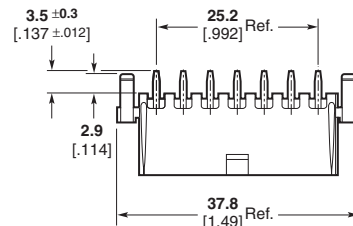

**Recommended PC Board Layout**

| Number of Positions | PCB Pegs | Drain Holes | Plating | Part Number       |                 |
|---------------------|----------|-------------|---------|-------------------|-----------------|
|                     |          |             |         | UL 94V-2, Natural | UL 94V-0, White |
| 14                  | Y        | N           | Tin     | 1-1586489-4       | 1-1586493-4     |
|                     | Y        | N           | 30 Gold | 1-1586490-4       | 1-1586494-4     |
|                     | N        | N           | Tin     | 1-1586491-4       | 1-1586495-4     |
|                     | N        | N           | 30 Gold | 1-1586492-4       | 1-1586496-4     |
|                     | Y        | Y           | Tin     | 1-794308-1        | 1-794453-1      |
|                     | Y        | Y           | 30 Gold | 1-794308-2        | 1-794453-2      |
|                     | N        | Y           | Tin     | 1-794355-1        | 1-794489-1      |
|                     | N        | Y           | 30 Gold | 1-794355-2        | 1-794489-2      |

**Note:** All part numbers are RoHS Compliant.

**AMP-DUAC Connectors (Continued)**

**Vertical Header Assemblies (Continued)**

**16 Position, with and without Pegs and with and without Drain Holes**

**Material and Finish**

**Housing**—Nylon  
UL 94V-2, Natural color  
UL 94V-0, White color  
**Contacts**—0.25 [.010] thick copper alloy

**Related Product Data**

**Mate with**—Receptacle housings (page 126).  
**Technical Documents**—pages 125 and 205-206

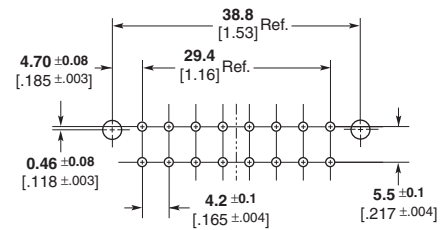
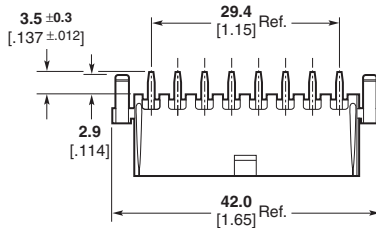

**Recommended PC Board Layout**

| Number of Positions | PCB Pegs | Drain Holes | Plating | Part Number       |                 |
|---------------------|----------|-------------|---------|-------------------|-----------------|
|                     |          |             |         | UL 94V-2, Natural | UL 94V-0, White |
| 16                  | Y        | N           | Tin     | 1-1586489-6       | 1-1586493-6     |
|                     | Y        | N           | 30 Gold | 1-1586490-6       | 1-1586494-6     |
|                     | N        | N           | Tin     | 1-1586491-6       | 1-1586495-6     |
|                     | N        | N           | 30 Gold | 1-1586492-6       | 1-1586496-6     |
|                     | Y        | Y           | Tin     | 1-794309-1        | 1-794429-1      |
|                     | Y        | Y           | 30 Gold | 1-794309-2        | 1-794429-2      |
|                     | N        | Y           | Tin     | 1-794356-1        | 1-794490-1      |
|                     | N        | Y           | 30 Gold | 1-794356-2        | 1-794490-2      |

**18 Position, with and without Pegs and with and without Drain Holes**

**Material and Finish**

**Housing**—Nylon  
UL 94V-2, Natural color  
UL 94V-0, White color  
**Contacts**—0.25 [.010] thick copper alloy

**Related Product Data**

**Mate with**—Receptacle housings (page 126).  
**Technical Documents**—pages 125 and 205-206

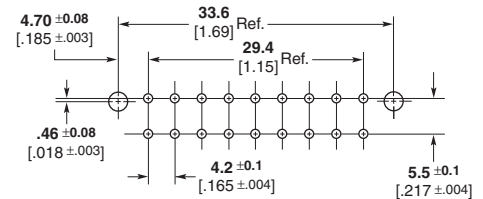

**Recommended PC Board Layout**

| Number of Positions | PCB Pegs | Drain Holes | Plating | Part Number       |                 |
|---------------------|----------|-------------|---------|-------------------|-----------------|
|                     |          |             |         | UL 94V-2, Natural | UL 94V-0, White |
| 18                  | Y        | N           | Tin     | 1-1586489-8       | 1-1586493-8     |
|                     | Y        | N           | 30 Gold | 1-1586490-8       | 1-1586494-8     |
|                     | N        | N           | Tin     | 1-1586491-8       | 1-1586495-8     |
|                     | N        | N           | 30 Gold | 1-1586492-8       | 1-1586496-8     |
|                     | Y        | Y           | Tin     | 1-794310-1        | 1-794454-1      |
|                     | Y        | Y           | 30 Gold | 1-794310-2        | 1-794454-2      |
|                     | N        | Y           | Tin     | 1-794357-1        | 1-794491-1      |
|                     | N        | Y           | 30 Gold | 1-794357-2        | 1-794491-2      |

**Note:** All part numbers are RoHS Compliant.

**AMP-DUAC Connectors (Continued)**

**Vertical Header Assemblies (Continued)**

**20 Position, with and without Pegs and with and without Drain Holes**

**Material and Finish**

**Housing**—Nylon  
UL 94V-2, Natural color  
UL 94V-0, White color

**Contacts**—0.25 [.010] thick copper alloy

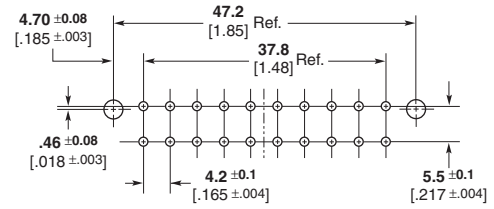
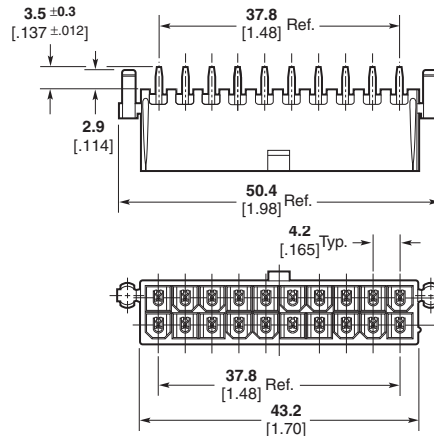

**Recommended PC Board Layout**

**Related Product Data**

**Mate with**—Receptacle housings (page 126).

**Technical Documents**—pages 125 and 205-206

| Number of Positions | PCB Pegs | Drain Holes | Plating | Part Number       |                 |
|---------------------|----------|-------------|---------|-------------------|-----------------|
|                     |          |             |         | UL 94V-2, Natural | UL 94V-0, White |
| 20                  | Y        | N           | Tin     | 2-1586489-0       | 2-1586493-0     |
|                     | Y        | N           | 30 Gold | 2-1586490-0       | 2-1586494-0     |
|                     | N        | N           | Tin     | 2-1586491-0       | 2-1586495-0     |
|                     | N        | N           | 30 Gold | 2-1586492-0       | 2-1586496-0     |
|                     | Y        | Y           | Tin     | 1-794311-1        | 1-794455-1      |
|                     | Y        | Y           | 30 Gold | 1-794311-2        | 1-794455-2      |
|                     | N        | Y           | Tin     | 1-794358-1        | 1-794492-1      |
|                     | N        | Y           | 30 Gold | 1-794358-2        | 1-794492-2      |

**High Temperature Headers**

IR Reflow compatible, UL 94V-0, Black color

| Number of Positions | PCB Pegs | Drain Holes | Plating | Part Number     |
|---------------------|----------|-------------|---------|-----------------|
|                     |          |             |         | UL 94V-0, Black |
| 20                  | N        | N           | Tin     | 1-794415-1      |
|                     | N        | N           | 30 Gold | 1-794415-2      |

**22 Position, with and without Pegs and with and without Drain Holes**

**Material and Finish**

**Housing**—Nylon  
UL 94V-2, Natural color  
UL 94V-0, White color

**Contacts**—0.25 [.010] thick copper alloy

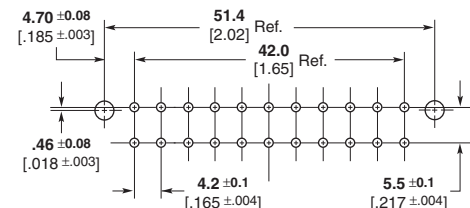
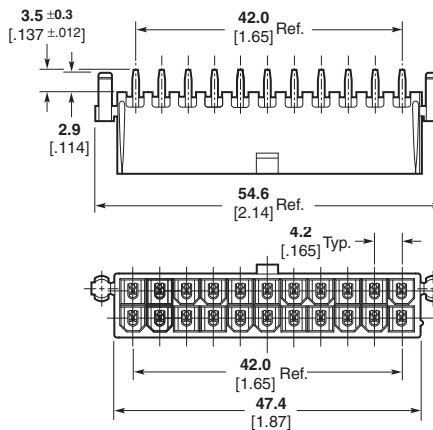

**Recommended PC Board Layout**

**Related Product Data**

**Mate with**—Receptacle housings (page 126).

**Technical Documents**—pages 125 and 205-206

| Number of Positions | PCB Pegs | Drain Holes | Plating | Part Number       |                 |
|---------------------|----------|-------------|---------|-------------------|-----------------|
|                     |          |             |         | UL 94V-2, Natural | UL 94V-0, White |
| 22                  | Y        | N           | Tin     | 2-1586489-2       | 2-1586493-2     |
|                     | Y        | N           | 30 Gold | 2-1586490-2       | 2-1586494-2     |
|                     | N        | N           | Tin     | 2-1586491-2       | 2-1586495-2     |
|                     | N        | N           | 30 Gold | 2-1586492-2       | 2-1586496-2     |
|                     | Y        | Y           | Tin     | 1-794312-1        | 1-794471-1      |
|                     | Y        | Y           | 30 Gold | 1-794312-2        | 1-794471-2      |
|                     | N        | Y           | Tin     | 1-794359-1        | 1-794493-1      |
|                     | N        | Y           | 30 Gold | 1-794359-2        | 1-794493-2      |

**Note:** All part numbers are RoHS Compliant.

**AMP-DUAC Connectors (Continued)**

**Vertical Header Assemblies (Continued)**

**24 Position, with and without Pegs and with and without Drain Holes**

**Material and Finish**

**Housing**—Nylon  
UL 94V-2, Natural color  
UL 94V-0, White color

**Contacts**—0.25 [.010] thick copper alloy



Recommended PC Board Layout

**Related Product Data**

**Mate with**—Receptacle housings (page 126).

**Technical Documents**—pages 125 and 205-206

| Number of Positions | PCB Pegs | Drain Holes | Plating | Part Number       |                 |
|---------------------|----------|-------------|---------|-------------------|-----------------|
|                     |          |             |         | UL 94V-2, Natural | UL 94V-0, White |
| 24                  | Y        | N           | Tin     | 2-1586489-4       | 2-1586493-4     |
|                     | Y        | N           | 30 Gold | 2-1586490-4       | 2-1586494-4     |
|                     | N        | N           | Tin     | 2-1586491-4       | 2-1586495-4     |
|                     | N        | N           | 30 Gold | 2-1586492-4       | 2-1586496-4     |
|                     | Y        | Y           | Tin     | 794313-3          | 1-794472-1      |
|                     | Y        | Y           | 30 Gold | 794313-4          | 1-794472-2      |
|                     | N        | Y           | Tin     | 1-794360-1        | 1-794494-1      |
|                     | N        | Y           | 30 Gold | 1-794360-2        | 1-794494-2      |

**Right-Angle Header Assemblies**

**2-24 Position, with Pegs and without Drain Holes**

**Material and Finish**

**Housing**—Nylon  
UL 94V-2, Natural color  
UL 94V-0, White color

**Contacts**—Copper alloy



Recommended Mounting Hole Pattern For 1.78 [.070] Max. Thick PC Board (Component Side Shown)

| Number of Positions | PCB Pegs | Drain Holes | Plating | Part Number       |                 |
|---------------------|----------|-------------|---------|-------------------|-----------------|
|                     |          |             |         | UL 94V-2, Natural | UL 94V-0, White |
| 2                   | Y        | N           | Tin     | 1-794507-1        | 1-794526-1      |
| 4                   | Y        | N           | Tin     | 1-794508-1        | 1-794527-1      |
| 6                   | Y        | N           | Tin     | 1-794448-1        | 1-794528-1      |
| 8                   | Y        | N           | Tin     | 1-794509-1        | 1-794529-1      |
| 10                  | Y        | N           | Tin     | 1-794510-1        | 1-794530-1      |
| 12                  | Y        | N           | Tin     | 1-794511-1        | 1-794531-1      |
| 14                  | Y        | N           | Tin     | 1-794512-1        | 1-794532-1      |
| 16                  | Y        | N           | Tin     | 1-794513-1        | 1-794533-1      |
| 18                  | Y        | N           | Tin     | 1-794514-1        | 1-794588-1      |
| 20                  | Y        | N           | Tin     | 1-794449-1        | 1-794534-1      |
| 22                  | Y        | N           | Tin     | 1-794515-1        | 1-794589-1      |
| 24                  | Y        | N           | Tin     | 1-794516-1        | 1-794590-1      |

**Note:** All part numbers are RoHS Compliant.

---

**Engineering Notes**

---



# Mouser Electronics

Authorized Distributor

Click to View Pricing, Inventory, Delivery & Lifecycle Information:

[TE Connectivity:](#)

[770342-1](#)