

8 PIN SOP PHOTOTRANSISTOR DUAL CHANNEL PHOTOCOUPLER ELD20X Series ELD21X Series

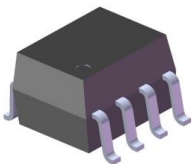

Features:

- Dual channel coupler
- Current transfer ratios offered in narrow ranges

| | |
|------------------|---------------|
| ELD205: 40-80% | ELD211: >20% |
| ELD206: 63-125% | ELD213: >100% |
| ELD207: 100-200% | ELD217: >100% |
- High isolation voltage between input and output (Viso = 3750 Vrms)
- Operating temperature range of -55 to +110°C
- High BVceo of 80V
- Standard SO-8 footprint package
- Pb free and RoHS compliant.
- UL and cUL approved(No. E214129)
- VDE approval (No. 40028116)
- SEMKO approved
- NEMKO approved
- DEMKO approved
- FIMKO approved

Schematic

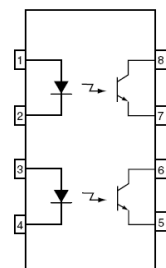

Pin Configuration

1. Anode
2. Cathode
3. Anode
4. Cathode
5. Emitter
6. Collector
7. Emitter
8. Collector

Description

The ELD20X and ELD21X series contain two infrared emitting diodes optically coupled to two phototransistor detectors.

The devices are packaged in an 8-pin small outline package which conforms to the standard SO-8 footprint.

Applications

- Feedback Control Circuits
- Interfacing and coupling systems of different potentials and impedances
- General Purpose Switching Circuits
- Monitor and Detection Circuits

Absolute Maximum Ratings (Ta=25°C)

| | Parameter | Symbol | Rating | Unit |
|--------|---|-----------|------------|-------|
| Input | Forward current | I_F | 60 | mA |
| | Peak forward current (t = 10μs) | I_{FM} | 1 | A |
| | Reverse voltage | V_R | 6 | V |
| | Power dissipation No derating needed | P_D | 90 | mW |
| Output | Collector power dissipation No derating needed | P_C | 150 | mW |
| | Collector-Emitter voltage | V_{CEO} | 80 | V |
| | Collector-Base voltage | V_{CBO} | 80 | V |
| | Emitter-Collector voltage | V_{ECO} | 7 | V |
| | Collector Current | I_C | 50 | mA |
| | Total Power Dissipation | P_{TOT} | 250 | mW |
| | Isolation Voltage* ¹ | V_{ISO} | 3750 | V rms |
| | Operating Temperature | T_{OPR} | -55 to 110 | °C |
| | Storage Temperature | T_{STG} | -55 to 125 | °C |
| | Soldering Temperature* ² | T_{SOL} | 260 | °C |

Notes:
 *1 AC for 1 minute, R.H.= 40 ~ 60% R.H. In this test, pins 1, 2, 3 & 4 are shorted together, and pins 5, 6, 7 & 8 are shorted together.
 *2 For 10 seconds

Electro-Optical Characteristics (Ta=25°C unless specified otherwise)

Input

| Parameter | Symbol | Min. | Typ. | Max. | Unit | Condition |
|-------------------|----------|------|------|------|---------------|--------------------------|
| Forward voltage | V_F | - | 1.2 | 1.5 | V | $I_F = 10\text{mA}$ |
| Reverse current | I_R | - | 0.1 | 100 | μA | $V_R = 6\text{V}$ |
| Input capacitance | C_{in} | - | 25 | - | pF | $V = 0, f = 1\text{MHz}$ |

Output

| Parameter | Symbol | Min | Typ. | Max. | Unit | Condition |
|-------------------------------------|------------|-----|------|------|------|---|
| Collector-Emitter dark current | I_{CEO} | - | 5.0 | 50 | nA | $V_{CE} = 10\text{V}, I_F = 0\text{mA}$ |
| Collector-Emitter breakdown voltage | BV_{CEO} | 80 | - | - | V | $I_C = 0.1\text{mA}$ |
| Emitter-Collector breakdown voltage | BV_{ECO} | 7 | - | - | V | $I_E = 0.1\text{mA}$ |
| Collector-Emitter capacitance | C_{CE} | - | 10 | - | pF | $V_{CE} = 0\text{V}, f = 1\text{MHz}$ |

Transfer Characteristics

| Parameter | Symbol | Min | Typ. | Max. | Unit | Condition |
|------------------------|--------|-----|------|------|------|---|
| Current Transfer Ratio | ELD205 | 40 | - | 80 | % | $I_F = 10\text{mA}, V_{CE} = 5\text{V}$ |
| | ELD206 | 63 | - | 125 | | |
| | ELD207 | 100 | - | 200 | | |
| | ELD211 | 20 | - | - | | |
| | ELD213 | 100 | - | - | | |
| Current Transfer Ratio | ELD205 | 13 | 30 | - | % | $I_F = 1\text{mA}, V_{CE} = 5\text{V}$ |
| | ELD206 | 22 | 45 | - | | |
| | ELD207 | 34 | 70 | - | | |
| | ELD217 | 100 | 120 | - | | |

* Typical values at $T_a = 25^\circ\text{C}$

Transfer Characteristics

| Parameter | Symbol | Min | Typ. | Max. | Unit | Condition |
|--------------------------------------|---------------|-----|-----------|------|----------|---|
| Collector-emitter saturation voltage | $V_{CE(sat)}$ | - | - | 0.4 | V | $I_F = 10mA, I_C = 2.5mA$ |
| Isolation resistance | R_{IO} | - | 10^{11} | - | Ω | $V_{IO} = 500Vdc$ |
| Input-output capacitance | C_{IO} | - | 0.5 | - | pF | $V_{IO} = 0, f = 1MHz$ |
| Turn-on time | T_{on} | - | 5.0 | - | μs | $V_{CC} = 10V,$ $I_C = 2mA, R_L = 100\Omega$ |
| Turn-off time | T_{off} | - | 4.0 | - | | |
| Rise time | T_r | - | 1.6 | - | | |
| Fall time | T_f | - | 2.2 | - | | |

* Typical values at $T_a = 25^\circ C$

Typical Electro-Optical Characteristics Curves

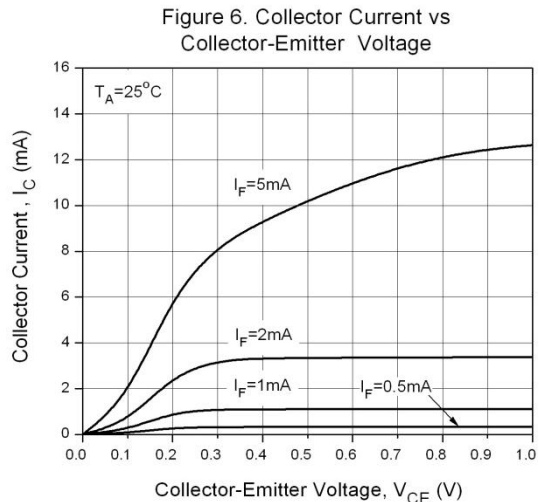
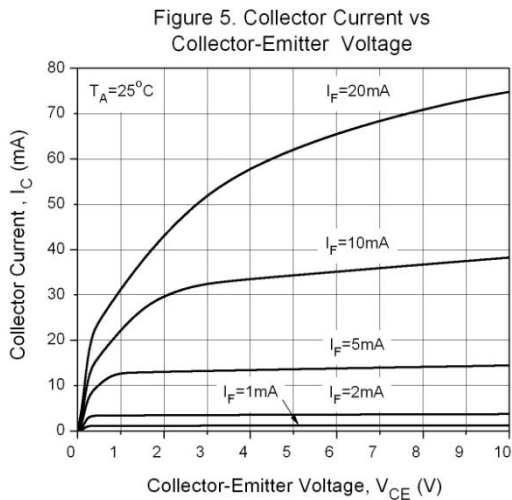
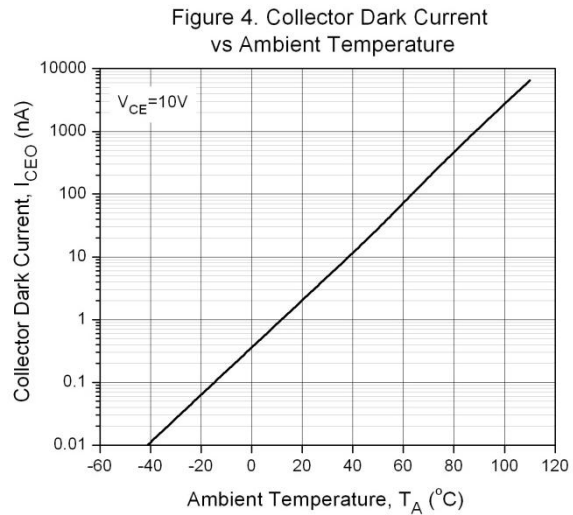
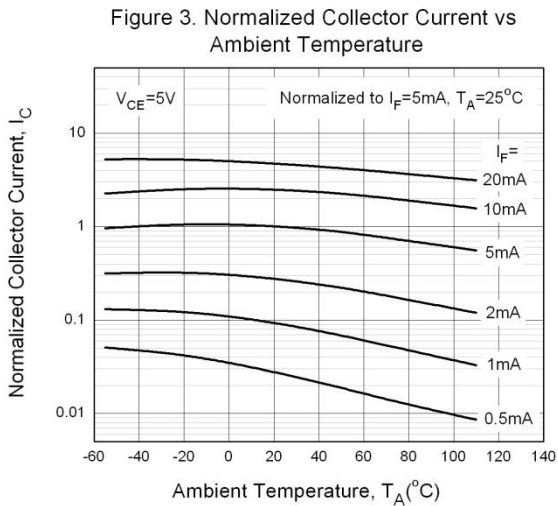
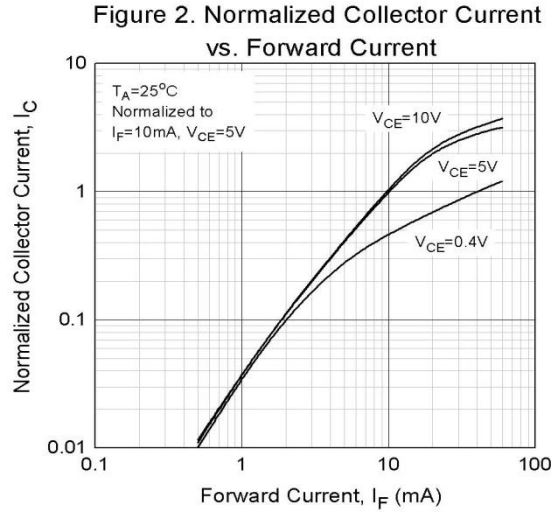
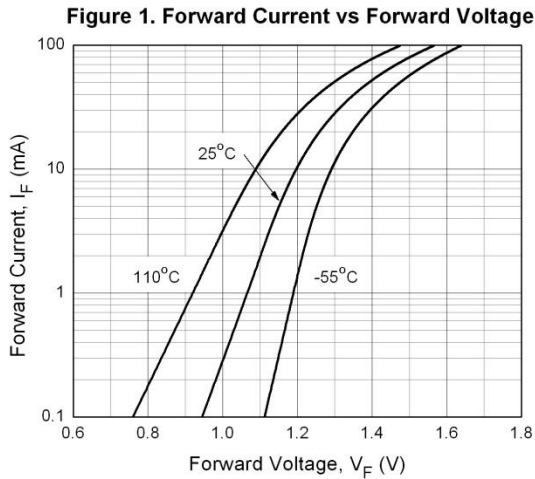

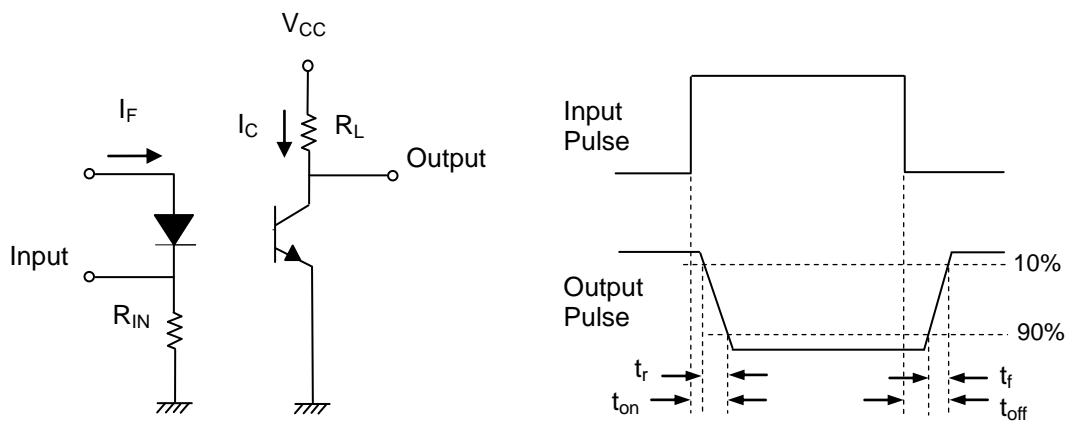
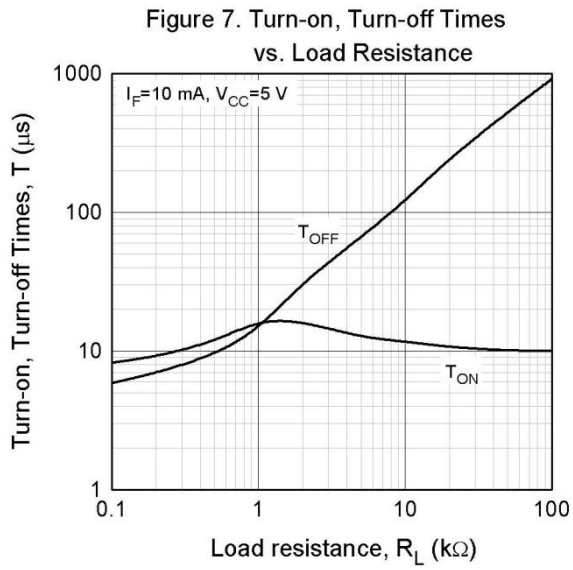

Figure 8. Switching Time Test Circuit & Waveforms

Order Information

Part Number

ELD2XX(Y)-V

Note

- XX = Part no. (05, 06, 07, 11, 13, or 17)
- Y = Tape and reel option (TA, TB or none).
- V = VDE safety (Optional)

| Option | Description | Packing quantity |
|--------|-----------------------------|---------------------|
| None | Standard | 100 units per tube |
| -V | Standard + VDE | 100 units per tube |
| (TA) | TA tape & reel option | 2000 units per reel |
| (TB) | TB tape & reel option | 2000 units per reel |
| (TA)-V | TA tape & reel option + VDE | 2000 units per reel |
| (TB)-V | TB tape & reel option + VDE | 2000 units per reel |

Package Dimension (Dimensions in mm)

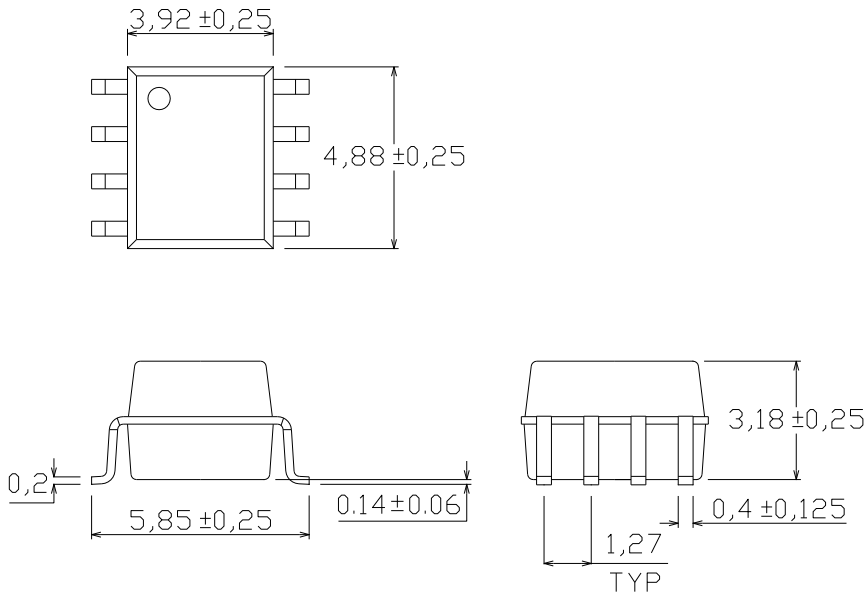

Recommended pad layout for surface mount leadform

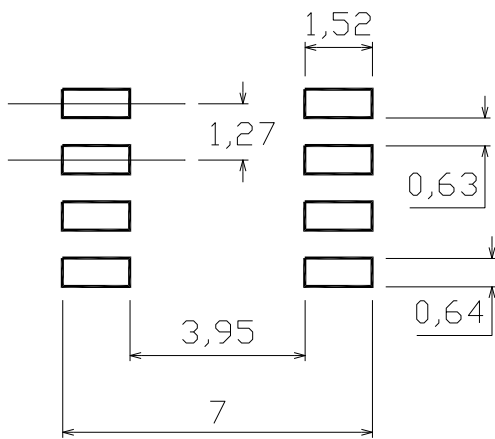

Device Marking

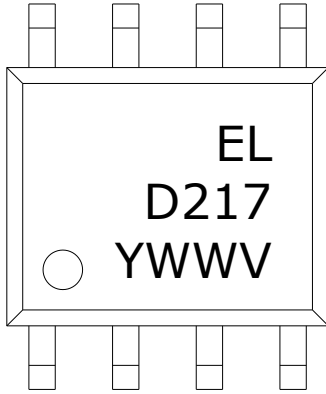

Notes

| | |
|------|---------------------------|
| EL | denotes Everlight |
| D217 | denotes Part Number |
| Y | denotes 1 digit Year code |
| WW | denotes 2 digit Week code |

Tape & Reel Packing Specifications

Option TA

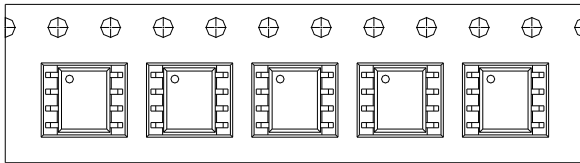

Option TB

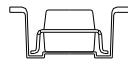
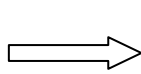
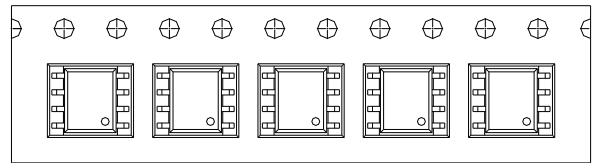

Direction of feed from reel

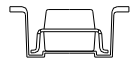
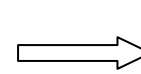

Direction of feed from reel

Tape dimensions

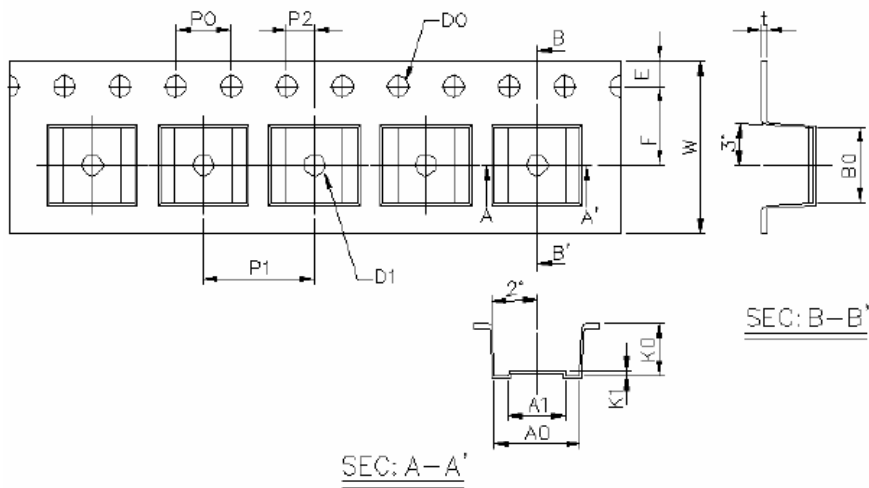

| | | | | | | | |
|----------------|-----------|-----------|-----------|-----------|-------------------|-----------|-----------|
| Dimension No. | A0 | A1 | B0 | D0 | D1 | E | F |
| Dimension (mm) | 6.2±0.1 | 4.1±0.1 | 5.28±0.1 | 1.5±0.1 | 1.5±0.3 | 1.75±0.1 | 5.5±0.1 |
| Dimension No. | Po | P1 | P2 | t | W | K0 | K1 |
| Dimension (mm) | 4.0±0.1 | 8.0±0.1 | 2.0±0.1 | 0.4±0.1 | 12.0+0.3/ -0.1 | 3.7±0.1 | 0.3±0.1 |

Precautions for Use

1. Soldering Condition

1.1 (A) Maximum Body Case Temperature Profile for evaluation of Reflow Profile

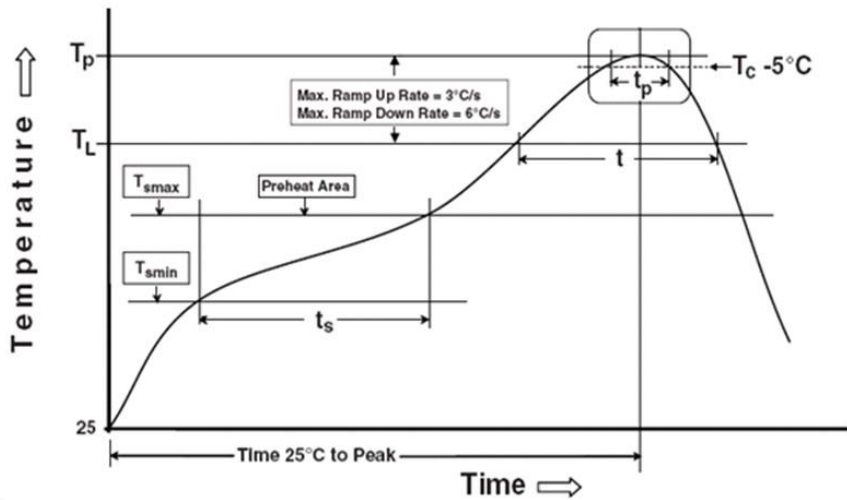

Note:

Reference: IPC/JEDEC J-STD-020D

Preheat

| | |
|--|-----------------|
| Temperature min (T_{smin}) | 150 °C |
| Temperature max (T_{smax}) | 200°C |
| Time (T_{smin} to T_{smax}) (t_s) | 60-120 seconds |
| Average ramp-up rate (T_{smax} to T_p) | 3 °C/second max |

Other

| | |
|--|------------------|
| Liquidus Temperature (T_L) | 217 °C |
| Time above Liquidus Temperature (t_L) | 60-100 sec |
| Peak Temperature (T_p) | 260°C |
| Time within 5 °C of Actual Peak Temperature: $T_p - 5^\circ\text{C}$ | 30 s |
| Ramp- Down Rate from Peak Temperature | 6°C /second max. |
| Time 25°C to peak temperature | 8 minutes max. |
| Reflow times | 3 times |

DISCLAIMER

1. Above specification may be changed without notice. EVERLIGHT will reserve authority on material change for above specification.
2. When using this product, please observe the absolute maximum ratings and the instructions for using outlined in these specification sheets. EVERLIGHT assumes no responsibility for any damage resulting from use of the product which does not comply with the absolute maximum ratings and the instructions included in these specification sheets.
3. These specification sheets include materials protected under copyright of EVERLIGHT corporation. Please don't reproduce or cause anyone to reproduce them without EVERLIGHT's consent.

Mouser Electronics

Authorized Distributor

Click to View Pricing, Inventory, Delivery & Lifecycle Information:

Everlight:

[ELD205](#) [ELD205\(TA\)](#) [ELD205\(TA\)-V](#) [ELD205\(TB\)](#) [ELD205\(TB\)-V](#) [ELD205-V](#) [ELD206](#) [ELD206\(TA\)](#) [ELD206\(TA\)-V](#) [ELD206\(TB\)](#) [ELD206\(TB\)-V](#) [ELD206-V](#) [ELD207](#) [ELD207\(TA\)](#) [ELD207\(TA\)-V](#) [ELD207\(TB\)](#) [ELD207\(TB\)-V](#) [ELD207-V](#) [ELD211](#) [ELD211\(TA\)](#) [ELD211\(TA\)-V](#) [ELD211\(TB\)](#) [ELD211\(TB\)-V](#) [ELD211-V](#) [ELD213](#) [ELD213\(TA\)](#) [ELD213\(TA\)-V](#) [ELD213\(TB\)](#) [ELD213\(TB\)-V](#) [ELD213-V](#) [ELD217](#) [ELD217\(TA\)](#) [ELD217\(TA\)-V](#) [ELD217\(TB\)](#) [ELD217\(TB\)-V](#) [ELD217-V](#)