

SN74AVCH20T245

20-BIT DUAL-SUPPLY BUS TRANSCEIVER

WITH CONFIGURABLE VOLTAGE TRANSLATION AND 3-STATE OUTPUTS

SCE5567F – MAY 2004 – REVISED APRIL 2005

- Control Inputs V_{IH}/V_{IL} Levels are Referenced to V_{CCA} Voltage
- V_{CC} Isolation Feature – If Either V_{CC} Input Is at GND, Both Ports Are in the High-Impedance State
- Overvoltage-Tolerant Inputs/Outputs Allow Mixed-Voltage-Mode Data Communications
- Fully Configurable Dual-Rail Design Allows Each Port to Operate Over the Full 1.2-V to 3.6-V Power-Supply Range
- I_{off} Supports Partial-Power-Down Mode Operation
- I/Os Are 4.6-V Tolerant
- Bus Hold on Data Inputs Eliminates the Need for External Pullup/Pulldown Resistors
- Max Data Rates
 - 380 Mbps (1.8-V to 3.3-V Translation)
 - 260 Mbps (< 1.8-V to 3.3-V Translation)
 - 260 Mbps (Translate to 2.5 V)
 - 210 Mbps (Translate to 1.8 V)
 - 120 Mbps (Translate to 1.5 V)
 - 100 Mbps (Translate to 1.2 V)
- Latch-Up Performance Exceeds 100 mA Per JESD 78, Class II
- ESD Protection Exceeds JESD 22
 - 8000-V Human-Body Model (A114-A)
 - 200-V Machine Model (A115-A)
 - 1000-V Charged-Device Model (C101)

DGG OR DGV PACKAGE
(TOP VIEW)

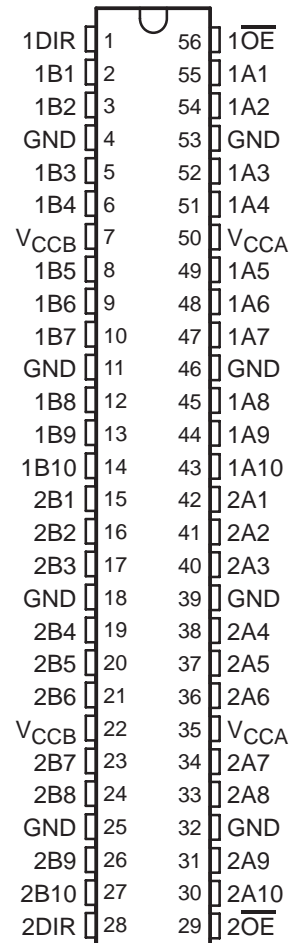

description/ordering information

This 20-bit noninverting bus transceiver uses two separate configurable power-supply rails. The SN74AVCH20T245 is optimized to operate with V_{CCA}/V_{CCB} set at 1.4 V to 3.6 V. It is operational with V_{CCA}/V_{CCB} as low as 1.2 V. The A port is designed to track V_{CCA} . V_{CCA} accepts any supply voltage from 1.2 V to 3.6 V. The B port is designed to track V_{CCB} . V_{CCB} accepts any supply voltage from 1.2 V to 3.6 V. This allows for universal low-voltage bidirectional translation between any of the 1.2-V, 1.5-V, 1.8-V, 2.5-V, and 3.3-V voltage nodes.

ORDERING INFORMATION

T_A	PACKAGE†		ORDERABLE PART NUMBER	TOP-SIDE MARKING
–40°C to 85°C	TSSOP – DGG	Tape and reel	SN74AVCH20T245GR	AVCH20T245
	TVSOP – DGV	Tape and reel	SN74AVCH20T245VR	WK245
	VFBGA – GQL	Tape and reel	SN74AVCH20T245KR	WK245
	VFBGA – ZQL (Pb-free)		74AVCH20T245ZQLR	

† Package drawings, standard packing quantities, thermal data, symbolization, and PCB design guidelines are available at www.ti.com/sc/package.



Please be aware that an important notice concerning availability, standard warranty, and use in critical applications of Texas Instruments semiconductor products and disclaimers thereto appears at the end of this data sheet.

PRODUCTION DATA information is current as of publication date. Products conform to specifications per the terms of Texas Instruments standard warranty. Production processing does not necessarily include testing of all parameters.



POST OFFICE BOX 655303 • DALLAS, TEXAS 75265

Copyright © 2005, Texas Instruments Incorporated

SN74AVCH20T245

20-BIT DUAL-SUPPLY BUS TRANSCEIVER

WITH CONFIGURABLE VOLTAGE TRANSLATION AND 3-STATE OUTPUTS

SCES567F – MAY 2004 – REVISED APRIL 2005

description/ordering information (continued)

The SN74AVCH20T245 is designed for asynchronous communication between data buses. The device transmits data from the A bus to the B bus or from the B bus to the A bus, depending on the logic level at the direction-control (DIR) input. The output-enable (\overline{OE}) input can be used to disable the outputs so that the buses are effectively isolated.

The SN74AVCH20T245 is designed so that the control (1DIR, 2DIR, $1\overline{OE}$, and $2\overline{OE}$) inputs are supplied by V_{CCA} .

This device is fully specified for partial-power-down applications using I_{off} . The I_{off} circuitry disables the outputs, preventing damaging current backflow through the device when it is powered down.

The V_{CC} isolation feature ensures that if either V_{CC} input is at GND, both outputs are in the high-impedance state. The bus-hold circuitry on the powered-up side always stays active.

Active bus-hold circuitry holds unused or undriven inputs at a valid logic state. Use of pullup or pulldown resistors with the bus-hold circuitry is not recommended.

To ensure the high-impedance state during power up or power down, \overline{OE} should be tied to V_{CC} through a pullup resistor; the minimum value of the resistor is determined by the current-sinking capability of the driver.

GQL OR ZQL PACKAGE (TOP VIEW)

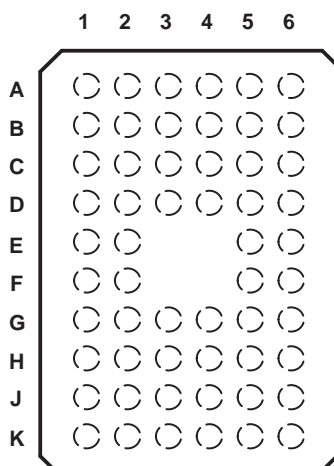

terminal assignments

	1	2	3	4	5	6
A	1B1	1B2	1DIR	$1\overline{OE}$	1A2	1A1
B	1B3	1B4	GND	GND	1A4	1A3
C	1B5	1B6	V_{CCB}	V_{CCA}	1A6	1A5
D	1B7	1B8	GND	GND	1A8	1A7
E	1B9	1B10			1A10	1A9
F	2B1	2B2			2A2	2A1
G	2B3	2B4	GND	GND	2A4	2A3
H	2B5	2B6	V_{CCB}	V_{CCA}	2A6	2A5
J	2B7	2B8	GND	GND	2A8	2A7
K	2B9	2B10	2DIR	$2\overline{OE}$	2A10	2A9

FUNCTION TABLE (each 10-bit section)

INPUTS		OPERATION
\overline{OE}	DIR	
L	L	B data to A bus
L	H	A data to B bus
H	X	Isolation

SN74AVCH20T245
20-BIT DUAL-SUPPLY BUS TRANSCEIVER
WITH CONFIGURABLE VOLTAGE TRANSLATION AND 3-STATE OUTPUTS

SCE5567F – MAY 2004 – REVISED APRIL 2005

logic diagram (positive logic)

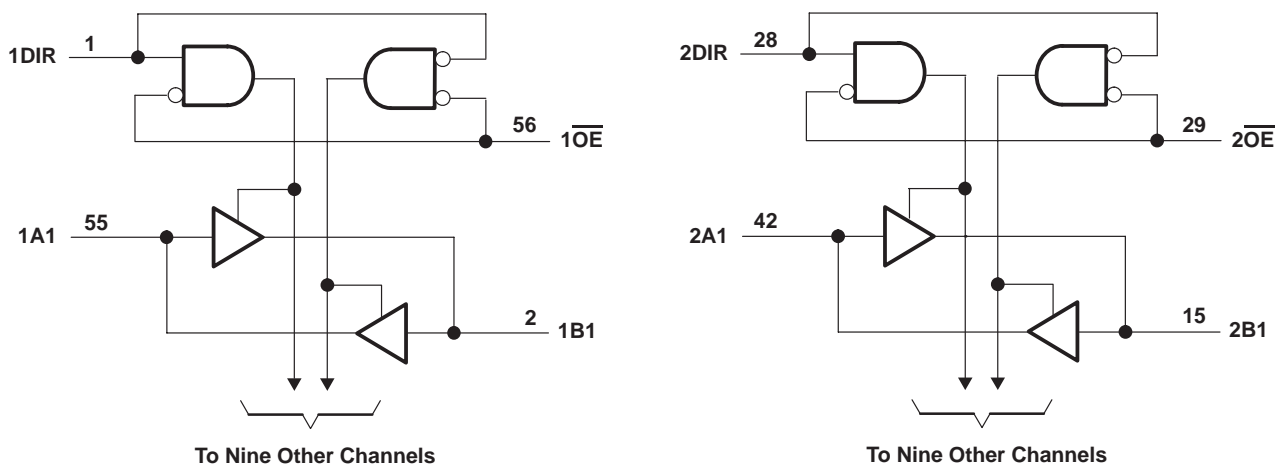

Pin numbers shown are for the DGG and DGV packages.

absolute maximum ratings over operating free-air temperature range (unless otherwise noted)†

Supply voltage range, V_{CCA} and V_{CCB}	-0.5 V to 4.6 V
Input voltage range, V_I (see Note 1): I/O ports (A port)	-0.5 V to 4.6 V
I/O ports (B port)	-0.5 V to 4.6 V
Control inputs	-0.5 V to 4.6 V
Voltage range applied to any output in the high-impedance or power-off state, V_O (see Note 1): (A port)	-0.5 V to 4.6 V
(B port)	-0.5 V to 4.6 V
Voltage range applied to any output in the high or low state, V_O (see Notes 1 and 2): (A port)	-0.5 V to $V_{CCA} + 0.5$ V
(B port)	-0.5 V to $V_{CCB} + 0.5$ V
Input clamp current, I_{IK} ($V_I < 0$)	-50 mA
Output clamp current, I_{OK} ($V_O < 0$)	-50 mA
Continuous output current, I_O	± 50 mA
Continuous current through each V_{CCA} , V_{CCB} , and GND	± 100 mA
Package thermal impedance, θ_{JA} (see Note 3): DGG package	64°C/W
DGV package	48°C/W
GQL/ZQL package	42°C/W
Storage temperature range, T_{stg}	-65°C to 150°C

† Stresses beyond those listed under “absolute maximum ratings” may cause permanent damage to the device. These are stress ratings only, and functional operation of the device at these or any other conditions beyond those indicated under “recommended operating conditions” is not implied. Exposure to absolute-maximum-rated conditions for extended periods may affect device reliability.

- NOTES: 1. The input voltage and output negative-voltage ratings may be exceeded if the input and output current ratings are observed.
 2. The output positive-voltage rating may be exceeded up to 4.6 V maximum if the output current rating is observed.
 3. The package thermal impedance is calculated in accordance with JESD 51-7.

SN74AVCH20T245

20-BIT DUAL-SUPPLY BUS TRANSCEIVER

WITH CONFIGURABLE VOLTAGE TRANSLATION AND 3-STATE OUTPUTS

SCES567F – MAY 2004 – REVISED APRIL 2005

recommended operating conditions (see Notes 4 through 8)

		V _{CCI}	V _{CCO}	MIN	MAX	UNIT
V _{CCA}	Supply voltage			1.2	3.6	V
V _{CCB}	Supply voltage			1.2	3.6	V
V _{IH}	High-level input voltage	Data inputs (see Note 7)	1.2 V to 1.95 V	V _{CCI} × 0.65		V
			1.95 V to 2.7 V	1.6		
			2.7 V to 3.6 V	2		
V _{IL}	Low-level input voltage	Data inputs (see Note 7)	1.2 V to 1.95 V	V _{CCI} × 0.35		V
			1.95 V to 2.7 V	0.7		
			2.7 V to 3.6 V	0.8		
V _{IH}	High-level input voltage	DIR (referenced to V _{CCA}) (see Note 8)	1.2 V to 1.95 V	V _{CCA} × 0.65		V
			1.95 V to 2.7 V	1.6		
			2.7 V to 3.6 V	2		
V _{IL}	Low-level input voltage	DIR (referenced to V _{CCA}) (see Note 8)	1.2 V to 1.95 V	V _{CCA} × 0.35		V
			1.95 V to 2.7 V	0.7		
			2.7 V to 3.6 V	0.8		
V _I	Input voltage			0	3.6	V
V _O	Output voltage	Active state		0	V _{CCO}	V
		3-state		0	3.6	V
I _{OH}	High-level output current		1.2 V	-3		mA
			1.4 V to 1.6 V	-6		
			1.65 V to 1.95 V	-8		
			2.3 V to 2.7 V	-9		
			3 V to 3.6 V	-12		
I _{OL}	Low-level output current		1.2 V	3		mA
			1.4 V to 1.6 V	6		
			1.65 V to 1.95 V	8		
			2.3 V to 2.7 V	9		
			3 V to 3.6 V	12		
Δt/Δv	Input transition rise or fall rate				5	ns/V
T _A	Operating free-air temperature			-40	85	°C

- NOTES:
- V_{CCI} is the V_{CC} associated with the data input port.
 - V_{CCO} is the V_{CC} associated with the output port.
 - All unused data inputs of the device must be held at V_{CCI} or GND to ensure proper device operation. Refer to the TI application report, *Implications of Slow or Floating CMOS Inputs*, literature number SCBA004.
 - For V_{CCI} values not specified in the data sheet, V_{IH(min)} = V_{CCI} × 0.7 V, V_{IL(max)} = V_{CCI} × 0.3 V.
 - For V_{CCI} values not specified in the data sheet, V_{IH(min)} = V_{CCA} × 0.7 V, V_{IL(max)} = V_{CCA} × 0.3 V.



SN74AVCH20T245
20-BIT DUAL-SUPPLY BUS TRANSCEIVER
WITH CONFIGURABLE VOLTAGE TRANSLATION AND 3-STATE OUTPUTS

SCE567F – MAY 2004 – REVISED APRIL 2005

electrical characteristics over recommended operating free-air temperature range (unless otherwise noted) (see Note 9)

PARAMETER	TEST CONDITIONS		V _{CCA}	V _{CCB}	T _A = 25°C			-40°C to 85°C		UNIT
					MIN	TYP	MAX	MIN	MAX	
V _{OH}	I _{OH} = -100 μA	V _I = V _{IH}	1.2 V to 3.6 V	1.2 V to 3.6 V				V _{CCO} - 0.2 V		V
	I _{OH} = -3 mA		1.2 V	1.2 V	0.95					
	I _{OH} = -6 mA		1.4 V	1.4 V				1.05		
	I _{OH} = -8 mA		1.65 V	1.65 V				1.2		
	I _{OH} = -9 mA		2.3 V	2.3 V				1.75		
	I _{OH} = -12 mA		3 V	3 V				2.3		
V _{OL}	I _{OL} = 100 μA	V _I = V _{IL}	1.2 V to 3.6 V	1.2 V to 3.6 V				0.2		V
	I _{OL} = 3 mA		1.2 V	1.2 V	0.15					
	I _{OL} = 6 mA		1.4 V	1.4 V				0.35		
	I _{OL} = 8 mA		1.65 V	1.65 V				0.45		
	I _{OL} = 9 mA		2.3 V	2.3 V				0.55		
	I _{OL} = 12 mA		3 V	3 V				0.7		
I _I	Control inputs	V _I = V _{CCA} or GND	1.2 V to 3.6 V	1.2 V to 3.6 V	±0.025	±0.25		±1	μA	
I _{BHL} [†]	V _I = 0.42 V		1.2 V	1.2 V	25				μA	
	V _I = 0.49 V		1.4 V	1.4 V				15		
	V _I = 0.58 V		1.65 V	1.65 V				25		
	V _I = 0.7 V		2.3 V	2.3 V				45		
	V _I = 0.8 V		3.3 V	3.3 V				100		
I _{BHH} [‡]	V _I = 0.78 V		1.2 V	1.2 V	-25				μA	
	V _I = 0.91 V		1.4 V	1.4 V				-15		
	V _I = 1.07 V		1.65 V	1.65 V				-25		
	V _I = 1.6 V		2.3 V	2.3 V				-45		
	V _I = 2 V		3.3 V	3.3 V				-100		
I _{BHLO} [§]	V _I = 0 to V _{CC}		1.2 V	1.2 V	50				μA	
			1.6 V	1.6 V				125		
			1.95 V	1.95 V				200		
			2.7 V	2.7 V				300		
			3.6 V	3.6 V				500		
I _{BHHO} [¶]	V _I = 0 to V _{CC}		1.2 V	1.2 V	-50				μA	
			1.6 V	1.6 V				-125		
			1.95 V	1.95 V				-200		
			2.7 V	2.7 V				-300		
			3.6 V	3.6 V				-500		

[†] The bus-hold circuit can sink at least the minimum low sustaining current at V_{IL} max. I_{BHL} should be measured after lowering V_{IN} to GND and then raising it to V_{IL} max.

[‡] The bus-hold circuit can source at least the minimum high sustaining current at V_{IH} min. I_{BHH} should be measured after raising V_{IN} to V_{CC} and then lowering it to V_{IH} min.

[§] An external driver must source at least I_{BHLO} to switch this node from low to high.

[¶] An external driver must sink at least I_{BHHO} to switch this node from high to low.

NOTE 9: V_{CCO} is the V_{CC} associated with the output port.

SN74AVCH20T245

20-BIT DUAL-SUPPLY BUS TRANSCEIVER

WITH CONFIGURABLE VOLTAGE TRANSLATION AND 3-STATE OUTPUTS

SCES567F – MAY 2004 – REVISED APRIL 2005

electrical characteristics over recommended operating free-air temperature range (unless otherwise noted) (see Notes 10 and 11) (continued)

PARAMETER		TEST CONDITIONS		V _{CCA}	V _{CCB}	T _A = 25°C			-40°C to 85°C		UNIT
						MIN	TYP	MAX	MIN	MAX	
I _{off}	A port	V _I or V _O = 0 to 3.6 V		0 V	0 to 3.6 V	±0.1	±1		±5		μA
	B port			0 to 3.6 V	0 V	±0.1	±1	±5			
I _{OZ} †	A or B ports	V _O = V _{CCO} or GND, V _I = V _{CCI} or GND	$\overline{OE} = V_{IH}$	3.6 V	3.6 V	±0.5	±2.5		±5		μA
	B port		$\overline{OE} =$ don't care	0 V	3.6 V			±5			
	A port			3.6 V	0 V			±5			
I _{CCA}	V _I = V _{CCI} or GND, I _O = 0			1.2 V to 3.6 V	1.2 V to 3.6 V				35		μA
				0 V	3.6 V			-5			
				3.6 V	0 V			35			
I _{CCB}	V _I = V _{CCI} or GND, I _O = 0			1.2 V to 3.6 V	1.2 V to 3.6 V				35		μA
				0 V	3.6 V			35			
				3.6 V	0 V			-5			
I _{CCA} + I _{CCB}	V _I = V _{CCI} or GND, I _O = 0			1.2 V to 3.6 V	1.2 V to 3.6 V				65		μA
C _i	Control inputs	V _I = 3.3 V or GND		3.3 V	3.3 V	3.5					pF
C _{io}	A or B ports	V _O = 3.3 V or GND		3.3 V	3.3 V	7					pF

† For I/O ports, the parameter I_{OZ} includes the input leakage current.

NOTES: 10. V_{CCO} is the V_{CC} associated with the output port.

11. V_{CCI} is the V_{CC} associated with the input port.

switching characteristics over recommended operating free-air temperature range,
V_{CCA} = 1.2 V (see Figure 1)

PARAMETER	FROM (INPUT)	TO (OUTPUT)	V _{CCB} = 1.2 V	V _{CCB} = 1.5 V	V _{CCB} = 1.8 V	V _{CCB} = 2.5 V	V _{CCB} = 3.3 V	UNIT
			TYP	TYP	TYP	TYP	TYP	
t _{PLH}	A	B	3.8	3.1	2.8	2.7	3.3	ns
t _{PHL}			3.8	3.1	2.8	2.7	3.3	
t _{PLH}	B	A	4.1	3.8	3.6	3.5	3.4	ns
t _{PHL}			4.1	3.8	3.6	3.5	3.4	
t _{PZH}	\overline{OE}	A	6.5	6.5	6.5	6.5	6.5	ns
t _{PZL}			6.5	6.5	6.5	6.5	6.5	
t _{PZH}	\overline{OE}	B	5.6	4.4	3.8	3.3	3.2	ns
t _{PZL}			5.6	4.4	3.8	3.3	3.2	
t _{PHZ}	\overline{OE}	A	6.4	6.4	6.4	6.4	6.4	ns
t _{PLZ}			6.4	6.4	6.4	6.4	6.4	
t _{PHZ}	\overline{OE}	B	5.7	4.6	4.7	4.1	5.4	ns
t _{PLZ}			5.7	4.6	4.7	4.1	5.4	



SN74AVCH20T245
20-BIT DUAL-SUPPLY BUS TRANSCEIVER
WITH CONFIGURABLE VOLTAGE TRANSLATION AND 3-STATE OUTPUTS

SCE5567F – MAY 2004 – REVISED APRIL 2005

switching characteristics over recommended operating free-air temperature range,
 $V_{CCA} = 1.5\text{ V} \pm 0.1\text{ V}$ (see Figure 1)

PARAMETER	FROM (INPUT)	TO (OUTPUT)	$V_{CCB} = 1.2\text{ V}$	$V_{CCB} = 1.5\text{ V} \pm 0.1\text{ V}$		$V_{CCB} = 1.8\text{ V} \pm 0.15\text{ V}$		$V_{CCB} = 2.5\text{ V} \pm 0.2\text{ V}$		$V_{CCB} = 3.3\text{ V} \pm 0.3\text{ V}$		UNIT
			TYP	MIN	MAX	MIN	MAX	MIN	MAX	MIN	MAX	
t_{PLH}	A	B	3.8	0.5	6.4	0.5	5.4	0.5	4.3	0.5	3.9	ns
t_{PHL}			3.8	0.5	6.4	0.5	5.4	0.5	4.3	0.5	3.9	
t_{PLH}	B	A	3.1	0.5	6.4	0.5	6.1	0.5	5.8	0.5	5.7	ns
t_{PHL}			3.1	0.5	6.4	0.5	6.1	0.5	5.8	0.5	5.7	
t_{PZH}	\overline{OE}	A	4.3	1.5	10.3	1.5	10.3	1.5	10.2	1.5	10.2	ns
t_{PZL}			4.3	1.5	10.3	1.5	10.3	1.5	10.2	1.5	10.2	
t_{PZH}	\overline{OE}	B	5.2	1	10.3	1	8.4	0.5	6.1	0.5	5.3	ns
t_{PZL}			5.2	1	10.3	1	8.4	0.5	6.1	0.5	5.3	
t_{PHZ}	\overline{OE}	A	4.5	2	9	2	9	2	9	2	9	ns
t_{PLZ}			4.5	2	9	2	9	2	9	2	9	
t_{PHZ}	\overline{OE}	B	5.1	1.5	9	1.5	7.8	1	6.4	1	5.9	ns
t_{PLZ}			5.1	1.5	9	1.5	7.8	1	6.4	1	5.9	

switching characteristics over recommended operating free-air temperature range,
 $V_{CCA} = 1.8\text{ V} \pm 0.15\text{ V}$ (see Figure 1)

PARAMETER	FROM (INPUT)	TO (OUTPUT)	$V_{CCB} = 1.2\text{ V}$	$V_{CCB} = 1.5\text{ V} \pm 0.1\text{ V}$		$V_{CCB} = 1.8\text{ V} \pm 0.15\text{ V}$		$V_{CCB} = 2.5\text{ V} \pm 0.2\text{ V}$		$V_{CCB} = 3.3\text{ V} \pm 0.3\text{ V}$		UNIT
			TYP	MIN	MAX	MIN	MAX	MIN	MAX	MIN	MAX	
t_{PLH}	A	B	3.6	0.5	6.1	0.5	5	0.5	3.9	0.5	3.5	ns
t_{PHL}			3.6	0.5	6.1	0.5	5	0.5	3.9	0.5	3.5	
t_{PLH}	B	A	2.8	0.5	5.4	0.5	5	0.5	4.7	0.5	4.6	ns
t_{PHL}			2.8	0.5	5.4	0.5	5	0.5	4.7	0.5	4.6	
t_{PZH}	\overline{OE}	A	3.4	1	8.1	1	7.9	1	7.9	1	7.9	ns
t_{PZL}			3.4	1	8.1	1	7.9	1	7.9	1	7.9	
t_{PZH}	\overline{OE}	B	5	0.5	10	0.5	7.9	0.5	5.7	0.5	4.8	ns
t_{PZL}			5	0.5	10	0.5	7.9	0.5	5.7	0.5	4.8	
t_{PHZ}	\overline{OE}	A	4.1	2	7.4	2	7.4	2	7.4	2	7.4	ns
t_{PLZ}			4.1	2	7.4	2	7.4	2	7.4	2	7.4	
t_{PHZ}	\overline{OE}	B	4.9	1.5	8.7	1.5	7.4	1	5.8	1	5.1	ns
t_{PLZ}			4.9	1.5	8.7	1.5	7.4	1	5.8	1	5.1	



SN74AVCH20T245
20-BIT DUAL-SUPPLY BUS TRANSCEIVER
WITH CONFIGURABLE VOLTAGE TRANSLATION AND 3-STATE OUTPUTS

SCES567F – MAY 2004 – REVISED APRIL 2005

switching characteristics over recommended operating free-air temperature range,
 $V_{CCA} = 2.5\text{ V} \pm 0.2\text{ V}$ (see Figure 1)

PARAMETER	FROM (INPUT)	TO (OUTPUT)	V _{CCB} = 1.2 V	V _{CCB} = 1.5 V ± 0.1 V		V _{CCB} = 1.8 V ± 0.15 V		V _{CCB} = 2.5 V ± 0.2 V		V _{CCB} = 3.3 V ± 0.3 V		UNIT
			TYP	MIN	MAX	MIN	MAX	MIN	MAX	MIN	MAX	
t _{PLH}	A	B	3.5	0.5	5.8	0.5	4.7	0.5	3.5	0.5	3	ns
t _{PHL}			3.5	0.5	5.8	0.5	4.7	0.5	3.5	0.5	3	
t _{PLH}	B	A	2.7	0.5	4.3	0.5	3.9	0.5	3.5	0.5	3.4	ns
t _{PHL}			2.7	0.5	4.3	0.5	3.9	0.5	3.5	0.5	3.4	
t _{PZH}	$\overline{\text{OE}}$	A	2.5	0.5	5.4	0.5	5.3	0.5	5.2	0.5	5.2	ns
t _{PZL}			2.5	0.5	5.4	0.5	5.3	0.5	5.2	0.5	5.2	
t _{PZH}	$\overline{\text{OE}}$	B	4.8	0.5	9.6	0.5	7.6	0.5	5.3	0.5	4.3	ns
t _{PZL}			4.8	0.5	9.6	0.5	7.6	0.5	5.3	0.5	4.3	
t _{PHZ}	$\overline{\text{OE}}$	A	3	1.1	5.2	1.1	5.2	1.1	5.2	1.1	5.2	ns
t _{PLZ}			3	1.1	5.2	1.1	5.2	1.1	5.2	1.1	5.2	
t _{PHZ}	$\overline{\text{OE}}$	B	4.7	1.2	8.2	1.2	6.9	1	5.3	1	5	ns
t _{PLZ}			4.7	1.2	8.2	1.2	6.9	1	5.3	1	5	

switching characteristics over recommended operating free-air temperature range,
 $V_{CCA} = 3.3\text{ V} \pm 0.3\text{ V}$ (see Figure 1)

PARAMETER	FROM (INPUT)	TO (OUTPUT)	V _{CCB} = 1.2 V	V _{CCB} = 1.5 V ± 0.1 V		V _{CCB} = 1.8 V ± 0.15 V		V _{CCB} = 2.5 V ± 0.2 V		V _{CCB} = 3.3 V ± 0.3 V		UNIT
			TYP	MIN	MAX	MIN	MAX	MIN	MAX	MIN	MAX	
t _{PLH}	A	B	3.4	0.5	5.7	0.5	4.6	0.5	3.4	0.5	2.9	ns
t _{PHL}			3.4	0.5	5.7	0.5	4.6	0.5	3.4	0.5	2.9	
t _{PLH}	B	A	3.3	0.5	3.9	0.5	3.5	0.5	3	0.5	2.9	ns
t _{PHL}			3.3	0.5	3.9	0.5	3.5	0.5	3	0.5	2.9	
t _{PZH}	$\overline{\text{OE}}$	A	2.2	0.5	4.4	0.5	4.3	0.5	4.2	0.5	4.1	ns
t _{PZL}			2.2	0.5	4.4	0.5	4.3	0.5	4.2	0.5	4.1	
t _{PZH}	$\overline{\text{OE}}$	B	4.7	1	9.6	0.5	7.5	0.5	5.1	0.5	4.1	ns
t _{PZL}			4.7	1	9.6	0.5	7.5	0.5	5.1	0.5	4.1	
t _{PHZ}	$\overline{\text{OE}}$	A	3.4	0.8	5	0.8	5	0.8	5	0.8	5	ns
t _{PLZ}			3.4	0.8	5	0.8	5	0.8	5	0.8	5	
t _{PHZ}	$\overline{\text{OE}}$	B	4.6	1.2	8.1	1.2	6.7	1	5.1	0.8	5	ns
t _{PLZ}			4.6	1.2	8.1	1.2	6.7	1	5.1	0.8	5	



SN74AVCH20T245
20-BIT DUAL-SUPPLY BUS TRANSCEIVER
WITH CONFIGURABLE VOLTAGE TRANSLATION AND 3-STATE OUTPUTS

SCE5567F – MAY 2004 – REVISED APRIL 2005

operating characteristics, $T_A = 25^\circ\text{C}$

PARAMETER			TEST CONDITIONS	$V_{CCA} =$ $V_{CCB} = 1.2\text{ V}$	$V_{CCA} =$ $V_{CCB} = 1.5\text{ V}$	$V_{CCA} =$ $V_{CCB} = 1.8\text{ V}$	$V_{CCA} =$ $V_{CCB} = 2.5\text{ V}$	$V_{CCA} =$ $V_{CCB} = 3.3\text{ V}$	UNIT
				TYP	TYP	TYP	TYP	TYP	
C_{pdA}^\dagger	A to B	Outputs Enabled	$C_L = 0,$ $f = 10\text{ MHz},$ $t_r = t_f = 1\text{ ns}$	1	1	1	1	2	pF
		Outputs Disabled		1	1	1	1	1	
	B to A	Outputs Enabled		12	13	14	15	16	
		Outputs Disabled		1	1	1	1	1	
C_{pdB}^\dagger	A to B	Outputs Enabled	$C_L = 0,$ $f = 10\text{ MHz},$ $t_r = t_f = 1\text{ ns}$	13	13	14	15	16	pF
		Outputs Disabled		1	1	1	1	1	
	B to A	Outputs Enabled		1	1	1	2	2	
		Outputs Disabled		1	1	1	1	1	

† Power-dissipation capacitance per transceiver

typical total static power consumption ($I_{CCA} + I_{CCB}$)

TABLE 1

V_{CCB}	V_{CCA}						UNIT
	0 V	1.2 V	1.5 V	1.8 V	2.5 V	3.3 V	
0 V	0	< 0.5	< 0.5	< 0.5	< 0.5	< 0.5	μA
1.2 V	< 0.5	< 1	< 1	< 1	< 1	1	
1.5 V	< 0.5	< 1	< 1	< 1	< 1	1	
1.8 V	< 0.5	< 1	< 1	< 1	< 1	< 1	
2.5 V	< 0.5	1	< 1	< 1	< 1	< 1	
3.3 V	< 0.5	1	< 1	< 1	< 1	< 1	

TYPICAL CHARACTERISTICS

TYPICAL PROPAGATION DELAY (A to B) vs LOAD CAPACITANCE
 $T_A = 25^\circ\text{C}, V_{CCA} = 1.2\text{ V}$

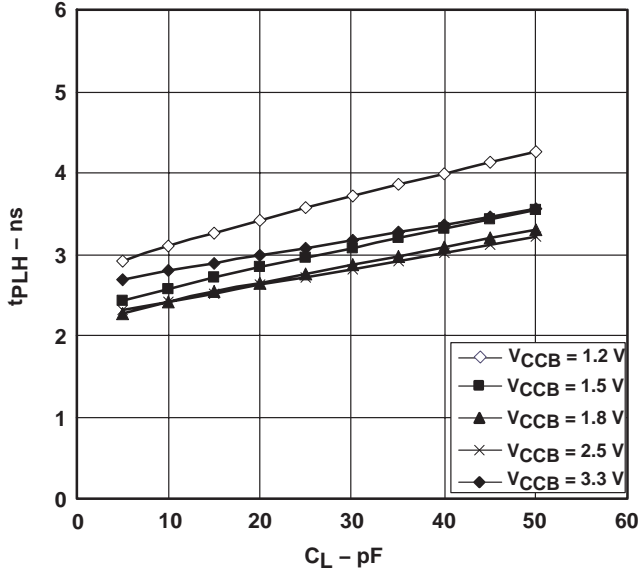

Figure 1

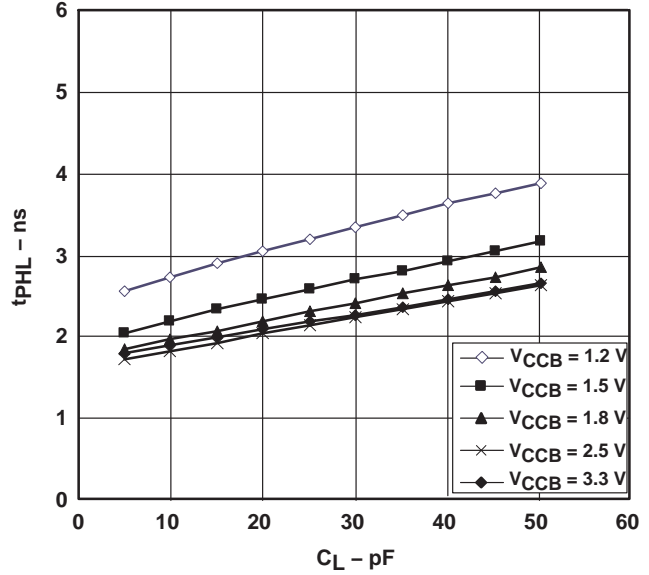

Figure 2

TYPICAL PROPAGATION DELAY (A to B) vs LOAD CAPACITANCE
 $T_A = 25^\circ\text{C}, V_{CCA} = 1.5\text{ V}$

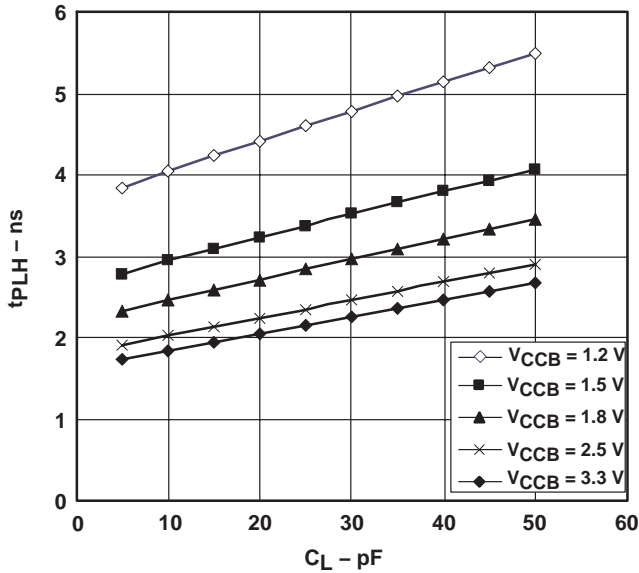

Figure 3

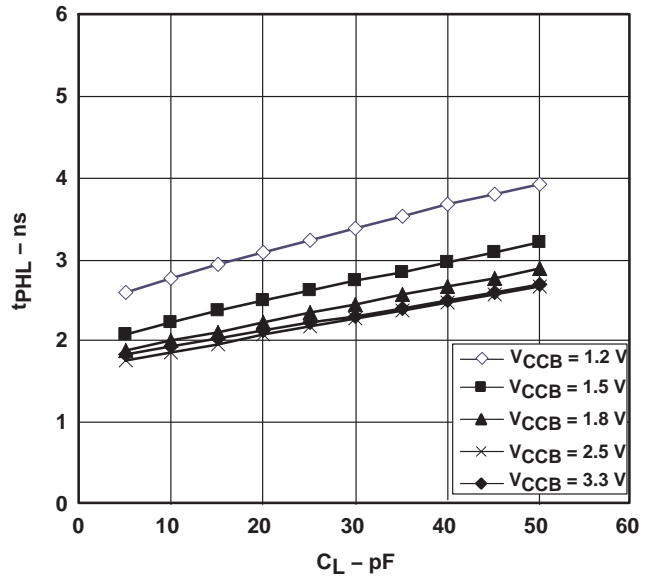

Figure 4

SN74AVCH20T245
20-BIT DUAL-SUPPLY BUS TRANSCEIVER
WITH CONFIGURABLE VOLTAGE TRANSLATION AND 3-STATE OUTPUTS

SCE567F – MAY 2004 – REVISED APRIL 2005

TYPICAL PROPAGATION DELAY (A to B) vs LOAD CAPACITANCE
 $T_A = 25^\circ\text{C}$, $V_{CCA} = 1.8\text{ V}$

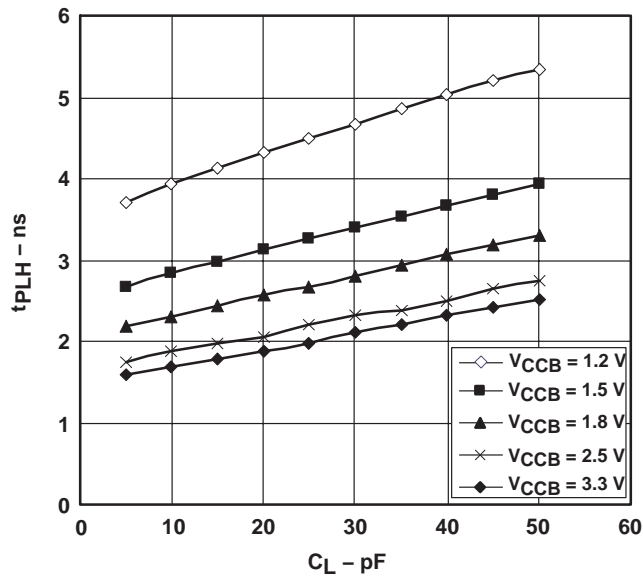

Figure 5

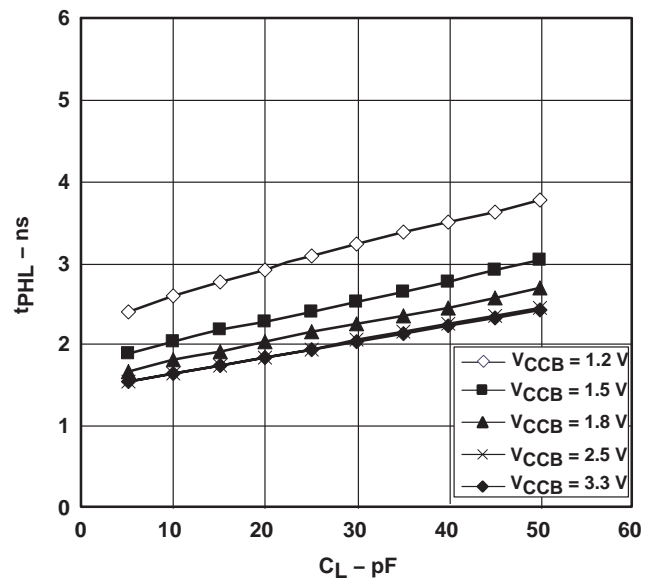

Figure 6

TYPICAL PROPAGATION DELAY (A to B) vs LOAD CAPACITANCE
 $T_A = 25^\circ\text{C}$, $V_{CCA} = 2.5\text{ V}$

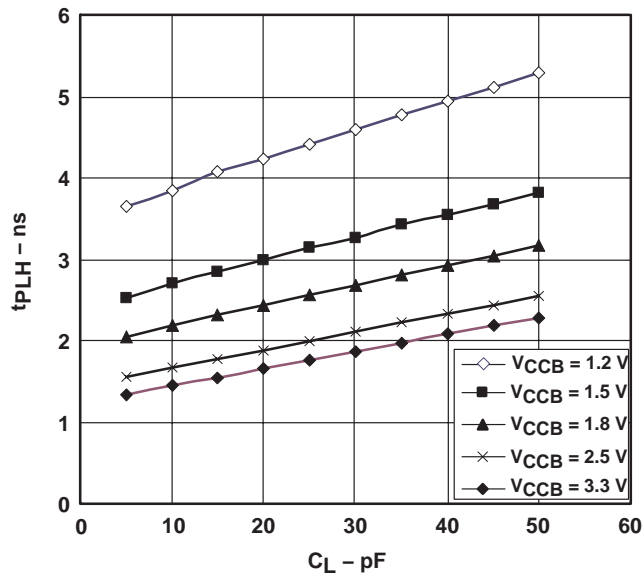

Figure 7

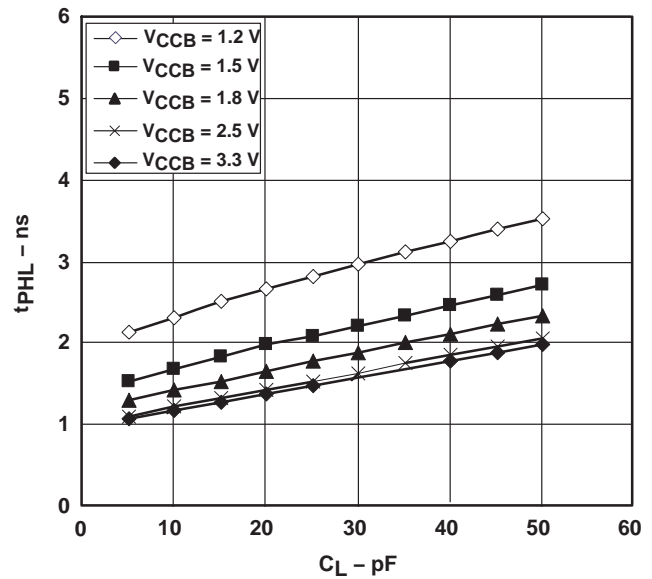

Figure 8

SN74AVCH20T245
20-BIT DUAL-SUPPLY BUS TRANSCEIVER
WITH CONFIGURABLE VOLTAGE TRANSLATION AND 3-STATE OUTPUTS

SCES567F – MAY 2004 – REVISED APRIL 2005

TYPICAL PROPAGATION DELAY (A to B) vs LOAD CAPACITANCE
 $T_A = 25^\circ\text{C}, V_{CCA} = 3.3\text{ V}$

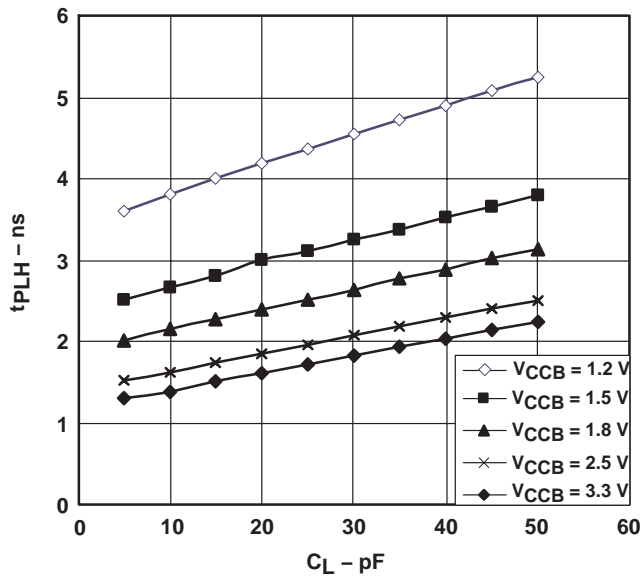

Figure 9

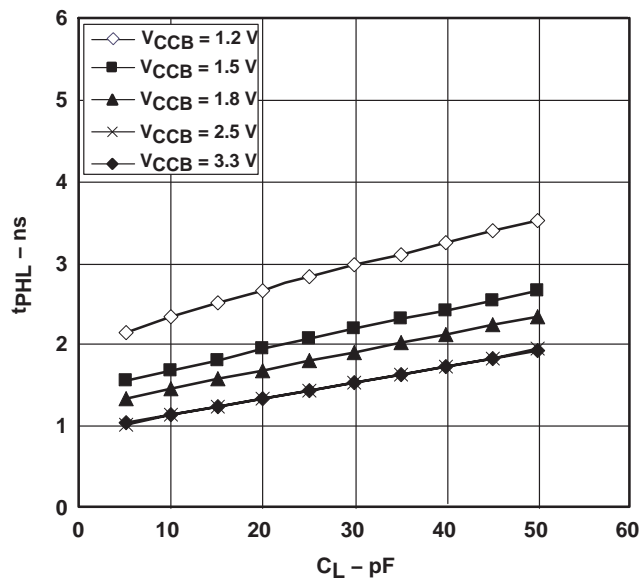
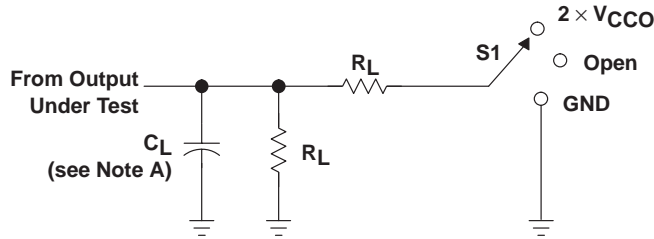

Figure 10

SN74AVCH20T245
20-BIT DUAL-SUPPLY BUS TRANSCEIVER
WITH CONFIGURABLE VOLTAGE TRANSLATION AND 3-STATE OUTPUTS

SCES567F – MAY 2004 – REVISED APRIL 2005

PARAMETER MEASUREMENT INFORMATION



LOAD CIRCUIT

TEST	S1
t_{pd}	Open
t_{PLZ}/t_{PZL}	$2 \times V_{CCO}$
t_{PHZ}/t_{PZH}	GND

V_{CCO}	C_L	R_L	V_{TP}
1.2 V	15 pF	2 k Ω	0.1 V
1.5 V \pm 0.1 V	15 pF	2 k Ω	0.1 V
1.8 V \pm 0.15 V	15 pF	2 k Ω	0.15 V
2.5 V \pm 0.2 V	15 pF	2 k Ω	0.15 V
3.3 V \pm 0.3 V	15 pF	2 k Ω	0.3 V

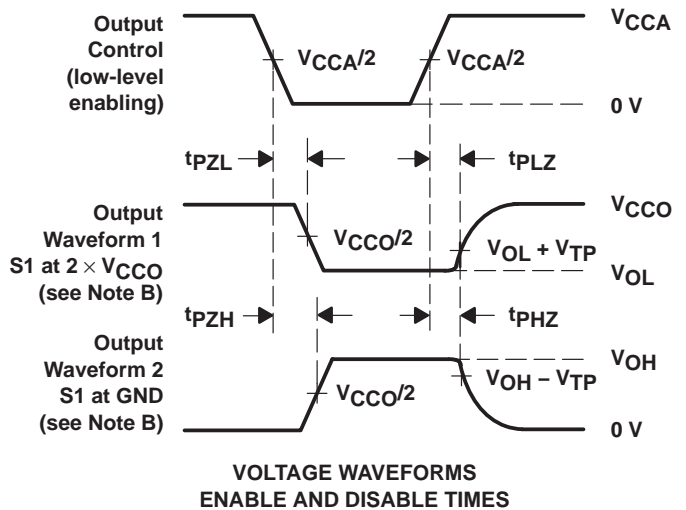
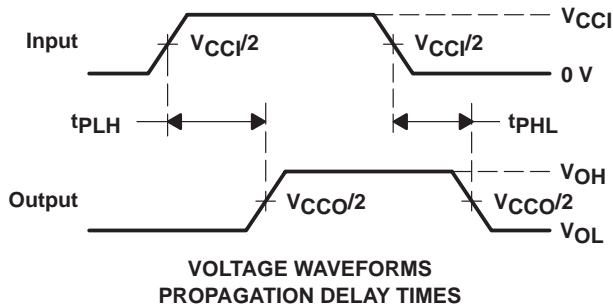
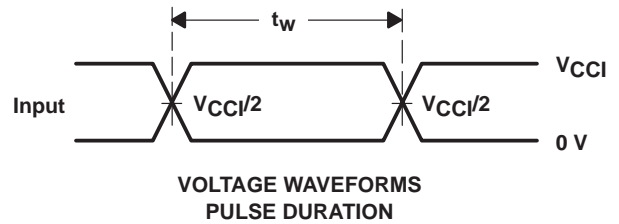

- NOTES:
- C_L includes probe and jig capacitance.
 - Waveform 1 is for an output with internal conditions such that the output is low, except when disabled by the output control. Waveform 2 is for an output with internal conditions such that the output is high, except when disabled by the output control.
 - All input pulses are supplied by generators having the following characteristics: PRR \leq 10 MHz, $Z_O = 50 \Omega$, $dv/dt \geq 1$ V/ns.
 - The outputs are measured one at a time, with one transition per measurement.
 - t_{PLZ} and t_{PHZ} are the same as t_{dis} .
 - t_{PZL} and t_{PZH} are the same as t_{en} .
 - t_{PLH} and t_{PHL} are the same as t_{pd} .
 - V_{CCI} is the V_{CC} associated with the input port.
 - V_{CCO} is the V_{CC} associated with the output port.

Figure 11. Load Circuit and Voltage Waveforms

PACKAGING INFORMATION

Orderable Device	Status (1)	Package Type	Package Drawing	Pins	Package Qty	Eco Plan (2)	Lead/Ball Finish (6)	MSL Peak Temp (3)	Op Temp (°C)	Device Marking (4/5)	Samples
74AVCH20T245ZQLR	LIFEBUY	BGA MICROSTAR JUNIOR	ZQL	56	1000	Green (RoHS & no Sb/Br)	SNAGCU	Level-1-260C-UNLIM	-40 to 85	WK245	
SN74AVCH20T245GR	ACTIVE	TSSOP	DGG	56	2000	Green (RoHS & no Sb/Br)	NIPDAU	Level-1-260C-UNLIM	-40 to 85	AVCH20T245	Samples
SN74AVCH20T245VR	ACTIVE	TVSOP	DGV	56	2000	Green (RoHS & no Sb/Br)	NIPDAU	Level-1-260C-UNLIM	-40 to 85	WK245	Samples

(1) The marketing status values are defined as follows:

ACTIVE: Product device recommended for new designs.

LIFEBUY: TI has announced that the device will be discontinued, and a lifetime-buy period is in effect.

NRND: Not recommended for new designs. Device is in production to support existing customers, but TI does not recommend using this part in a new design.

PREVIEW: Device has been announced but is not in production. Samples may or may not be available.

OBsolete: TI has discontinued the production of the device.

(2) **RoHS:** TI defines "RoHS" to mean semiconductor products that are compliant with the current EU RoHS requirements for all 10 RoHS substances, including the requirement that RoHS substance do not exceed 0.1% by weight in homogeneous materials. Where designed to be soldered at high temperatures, "RoHS" products are suitable for use in specified lead-free processes. TI may reference these types of products as "Pb-Free".

RoHS Exempt: TI defines "RoHS Exempt" to mean products that contain lead but are compliant with EU RoHS pursuant to a specific EU RoHS exemption.

Green: TI defines "Green" to mean the content of Chlorine (Cl) and Bromine (Br) based flame retardants meet JS709B low halogen requirements of <=1000ppm threshold. Antimony trioxide based flame retardants must also meet the <=1000ppm threshold requirement.

(3) MSL, Peak Temp. - The Moisture Sensitivity Level rating according to the JEDEC industry standard classifications, and peak solder temperature.

(4) There may be additional marking, which relates to the logo, the lot trace code information, or the environmental category on the device.

(5) Multiple Device Markings will be inside parentheses. Only one Device Marking contained in parentheses and separated by a "~" will appear on a device. If a line is indented then it is a continuation of the previous line and the two combined represent the entire Device Marking for that device.

(6) Lead/Ball Finish - Orderable Devices may have multiple material finish options. Finish options are separated by a vertical ruled line. Lead/Ball Finish values may wrap to two lines if the finish value exceeds the maximum column width.

Important Information and Disclaimer:The information provided on this page represents TI's knowledge and belief as of the date that it is provided. TI bases its knowledge and belief on information provided by third parties, and makes no representation or warranty as to the accuracy of such information. Efforts are underway to better integrate information from third parties. TI has taken and continues to take reasonable steps to provide representative and accurate information but may not have conducted destructive testing or chemical analysis on incoming materials and chemicals. TI and TI suppliers consider certain information to be proprietary, and thus CAS numbers and other limited information may not be available for release.

In no event shall TI's liability arising out of such information exceed the total purchase price of the TI part(s) at issue in this document sold by TI to Customer on an annual basis.

TAPE AND REEL INFORMATION

QUADRANT ASSIGNMENTS FOR PIN 1 ORIENTATION IN TAPE

*All dimensions are nominal

Device	Package Type	Package Drawing	Pins	SPQ	Reel Diameter (mm)	Reel Width W1 (mm)	A0 (mm)	B0 (mm)	K0 (mm)	P1 (mm)	W (mm)	Pin1 Quadrant
74AVCH20T245ZQLR	BGA MICROSTAR JUNIOR	ZQL	56	1000	330.0	16.4	4.8	7.3	1.5	8.0	16.0	Q1
SN74AVCH20T245GR	TSSOP	DGG	56	2000	330.0	24.4	8.6	15.6	1.8	12.0	24.0	Q1
SN74AVCH20T245VR	TVSOP	DGV	56	2000	330.0	24.4	6.8	11.7	1.6	12.0	24.0	Q1

TAPE AND REEL BOX DIMENSIONS

*All dimensions are nominal

Device	Package Type	Package Drawing	Pins	SPQ	Length (mm)	Width (mm)	Height (mm)
74AVCH20T245ZQLR	BGA MICROSTAR JUNIOR	ZQL	56	1000	350.0	350.0	43.0
SN74AVCH20T245GR	TSSOP	DGG	56	2000	367.0	367.0	45.0
SN74AVCH20T245VR	TVSOP	DGV	56	2000	367.0	367.0	45.0

DGV (R-PDSO-G**)

PLASTIC SMALL-OUTLINE

24 PINS SHOWN



- NOTES: A. All linear dimensions are in millimeters.
 B. This drawing is subject to change without notice.
 C. Body dimensions do not include mold flash or protrusion, not to exceed 0,15 per side.
 D. Falls within JEDEC: 24/48 Pins – MO-153
 14/16/20/56 Pins – MO-194



4222167/A 07/2015

NOTES:

1. All linear dimensions are in millimeters. Any dimensions in parenthesis are for reference only. Dimensioning and tolerancing per ASME Y14.5M.
2. This drawing is subject to change without notice.
3. This dimension does not include mold flash, protrusions, or gate burrs. Mold flash, protrusions, or gate burrs shall not exceed 0.15 mm per side.
4. Reference JEDEC registration MO-153.

EXAMPLE BOARD LAYOUT

DGG0056A

TSSOP - 1.2 mm max height

SMALL OUTLINE PACKAGE



LAND PATTERN EXAMPLE
SCALE:6X

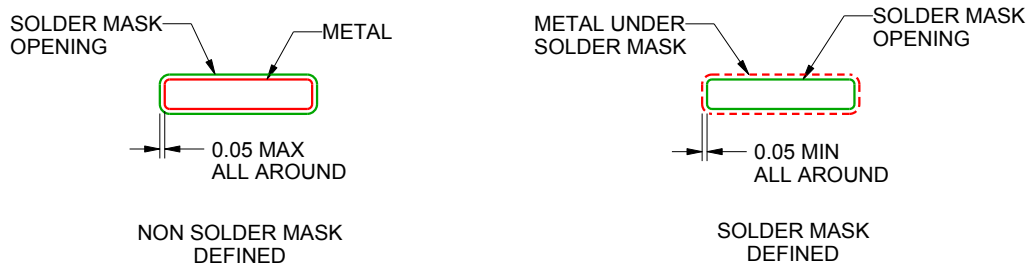

SOLDER MASK DETAILS

4222167/A 07/2015

NOTES: (continued)

- 5. Publication IPC-7351 may have alternate designs.
- 6. Solder mask tolerances between and around signal pads can vary based on board fabrication site.

EXAMPLE STENCIL DESIGN

DGG0056A

TSSOP - 1.2 mm max height

SMALL OUTLINE PACKAGE



SOLDER PASTE EXAMPLE
BASED ON 0.125 mm THICK STENCIL
SCALE:6X

4222167/A 07/2015

NOTES: (continued)

7. Laser cutting apertures with trapezoidal walls and rounded corners may offer better paste release. IPC-7525 may have alternate design recommendations.
8. Board assembly site may have different recommendations for stencil design.

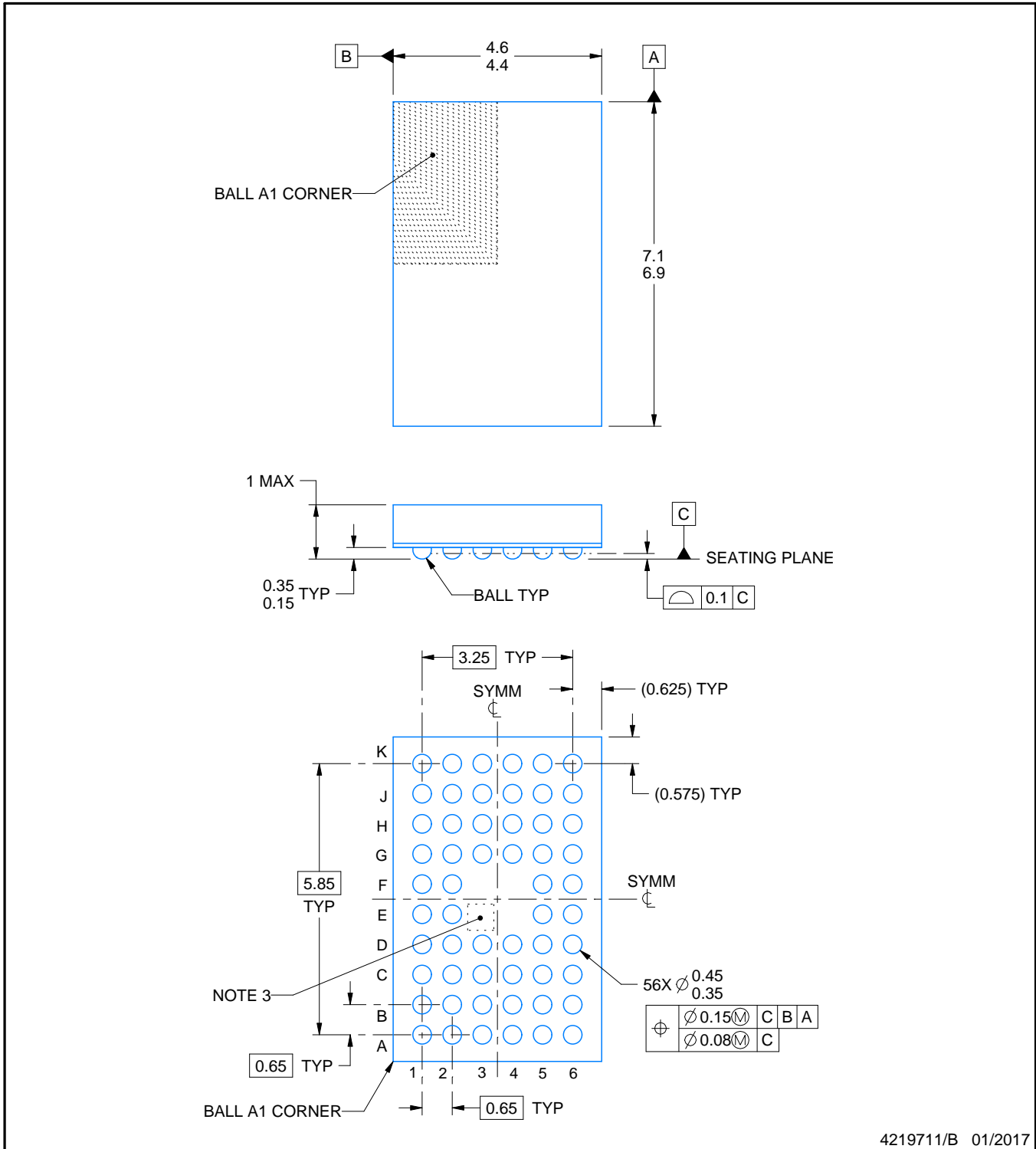
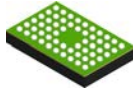

4219711/B 01/2017

NOTES:

1. All linear dimensions are in millimeters. Any dimensions in parenthesis are for reference only. Dimensioning and tolerancing per ASME Y14.5M.
2. This drawing is subject to change without notice.
3. No metal in this area, indicates orientation.

EXAMPLE BOARD LAYOUT

ZQL0056A

JRBGA - 1 mm max height

PLASTIC BALL GRID ARRAY

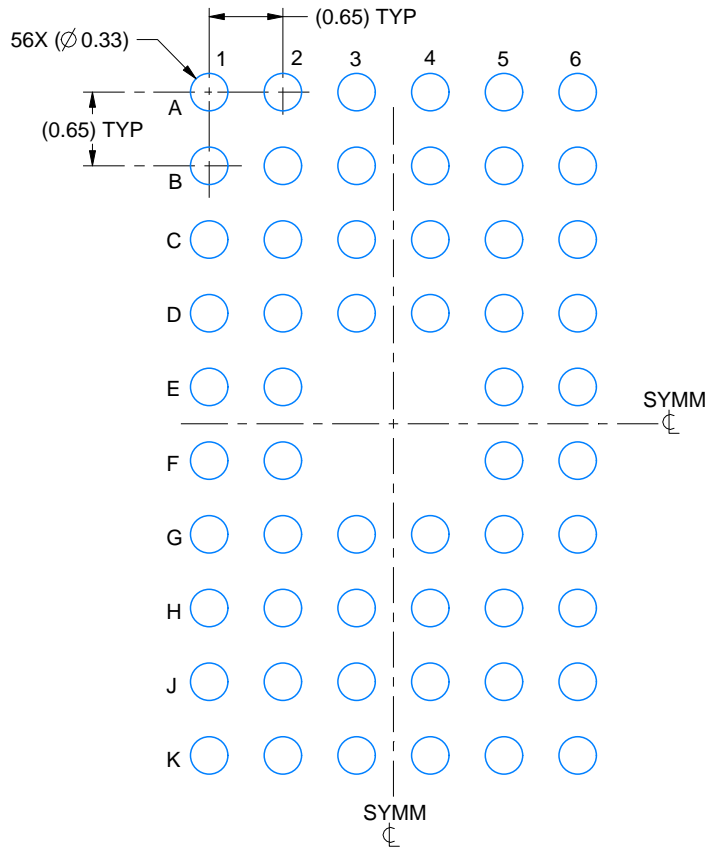

LAND PATTERN EXAMPLE
EXPOSED METAL SHOWN
SCALE:15X

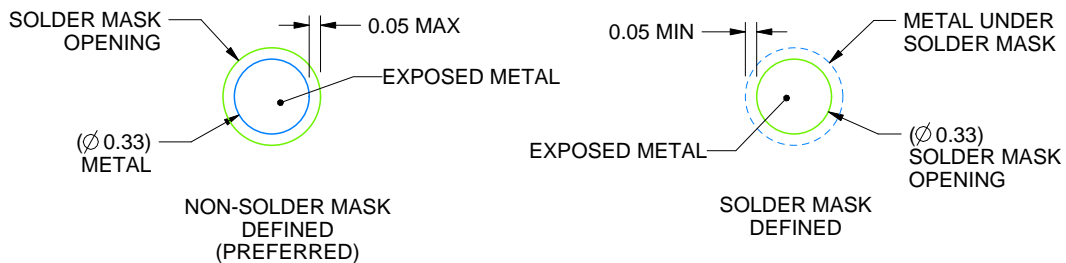

SOLDER MASK DETAILS
NOT TO SCALE

4219711/B 01/2017

NOTES: (continued)

- Final dimensions may vary due to manufacturing tolerance considerations and also routing constraints. For information, see Texas Instruments literature number SPRAA99 (www.ti.com/lit/spraa99).

EXAMPLE STENCIL DESIGN

ZQL0056A

JRBGA - 1 mm max height

PLASTIC BALL GRID ARRAY

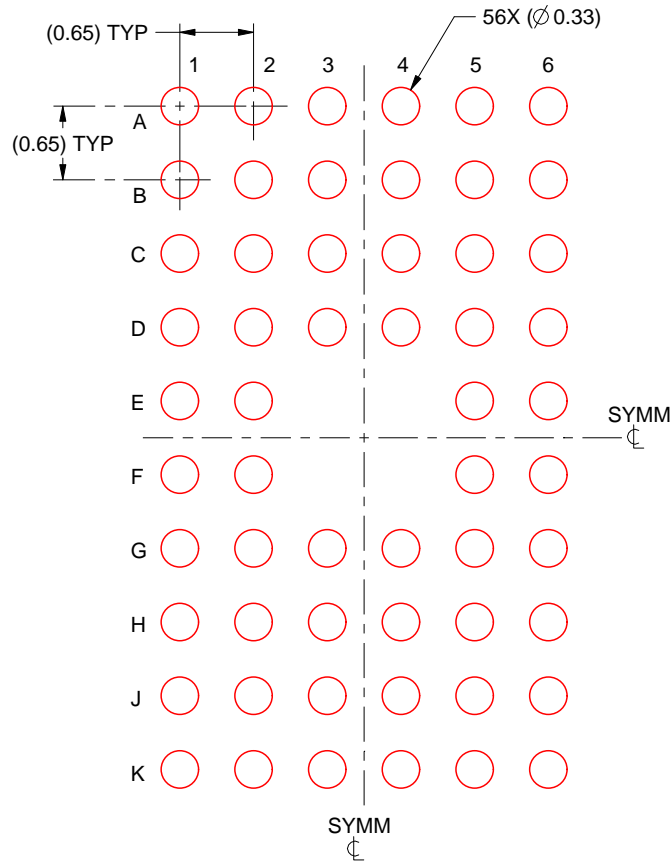

SOLDER PASTE EXAMPLE
BASED ON 0.125 mm THICK STENCIL
SCALE:15X

4219711/B 01/2017

NOTES: (continued)

5. Laser cutting apertures with trapezoidal walls and rounded corners may offer better paste release.

IMPORTANT NOTICE AND DISCLAIMER

TI PROVIDES TECHNICAL AND RELIABILITY DATA (INCLUDING DATASHEETS), DESIGN RESOURCES (INCLUDING REFERENCE DESIGNS), APPLICATION OR OTHER DESIGN ADVICE, WEB TOOLS, SAFETY INFORMATION, AND OTHER RESOURCES "AS IS" AND WITH ALL FAULTS, AND DISCLAIMS ALL WARRANTIES, EXPRESS AND IMPLIED, INCLUDING WITHOUT LIMITATION ANY IMPLIED WARRANTIES OF MERCHANTABILITY, FITNESS FOR A PARTICULAR PURPOSE OR NON-INFRINGEMENT OF THIRD PARTY INTELLECTUAL PROPERTY RIGHTS.

These resources are intended for skilled developers designing with TI products. You are solely responsible for (1) selecting the appropriate TI products for your application, (2) designing, validating and testing your application, and (3) ensuring your application meets applicable standards, and any other safety, security, or other requirements. These resources are subject to change without notice. TI grants you permission to use these resources only for development of an application that uses the TI products described in the resource. Other reproduction and display of these resources is prohibited. No license is granted to any other TI intellectual property right or to any third party intellectual property right. TI disclaims responsibility for, and you will fully indemnify TI and its representatives against, any claims, damages, costs, losses, and liabilities arising out of your use of these resources.

TI's products are provided subject to TI's Terms of Sale (www.ti.com/legal/termsofsale.html) or other applicable terms available either on ti.com or provided in conjunction with such TI products. TI's provision of these resources does not expand or otherwise alter TI's applicable warranties or warranty disclaimers for TI products.

Mailing Address: Texas Instruments, Post Office Box 655303, Dallas, Texas 75265
Copyright © 2020, Texas Instruments Incorporated