



Is Now Part of



ON Semiconductor®

To learn more about ON Semiconductor, please visit our website at
www.onsemi.com

Please note: As part of the Fairchild Semiconductor integration, some of the Fairchild orderable part numbers will need to change in order to meet ON Semiconductor's system requirements. Since the ON Semiconductor product management systems do not have the ability to manage part nomenclature that utilizes an underscore (_), the underscore (_) in the Fairchild part numbers will be changed to a dash (-). This document may contain device numbers with an underscore (_). Please check the ON Semiconductor website to verify the updated device numbers. The most current and up-to-date ordering information can be found at www.onsemi.com. Please email any questions regarding the system integration to Fairchild_questions@onsemi.com.

ON Semiconductor and the ON Semiconductor logo are trademarks of Semiconductor Components Industries, LLC dba ON Semiconductor or its subsidiaries in the United States and/or other countries. ON Semiconductor owns the rights to a number of patents, trademarks, copyrights, trade secrets, and other intellectual property. A listing of ON Semiconductor's product/patent coverage may be accessed at www.onsemi.com/site/pdf/Patent-Marking.pdf. ON Semiconductor reserves the right to make changes without further notice to any products herein. ON Semiconductor makes no warranty, representation or guarantee regarding the suitability of its products for any particular purpose, nor does ON Semiconductor assume any liability arising out of the application or use of any product or circuit, and specifically disclaims any and all liability, including without limitation special, consequential or incidental damages. Buyer is responsible for its products and applications using ON Semiconductor products, including compliance with all laws, regulations and safety requirements or standards, regardless of any support or applications information provided by ON Semiconductor. "Typical" parameters which may be provided in ON Semiconductor data sheets and/or specifications can and do vary in different applications and actual performance may vary over time. All operating parameters, including "Typicals" must be validated for each customer application by customer's technical experts. ON Semiconductor does not convey any license under its patent rights nor the rights of others. ON Semiconductor products are not designed, intended, or authorized for use as a critical component in life support systems or any FDA Class 3 medical devices or medical devices with a same or similar classification in a foreign jurisdiction or any devices intended for implantation in the human body. Should Buyer purchase or use ON Semiconductor products for any such unintended or unauthorized application, Buyer shall indemnify and hold ON Semiconductor and its officers, employees, subsidiaries, affiliates, and distributors harmless against all claims, costs, damages, and expenses, and reasonable attorney fees arising out of, directly or indirectly, any claim of personal injury or death associated with such unintended or unauthorized use, even if such claim alleges that ON Semiconductor was negligent regarding the design or manufacture of the part. ON Semiconductor is an Equal Opportunity/Affirmative Action Employer. This literature is subject to all applicable copyright laws and is not for resale in any manner.

FAN2001/FAN2002 1A High-Efficiency Step-Down DC-DC Converter

Features

- 96% Efficiency, Synchronous Operation
- Adjustable Output Voltage Options from 0.8V to V_{IN}
- 2.5V to 5.5V Input Voltage Range
- Up to 1A Output Current
- Fixed Frequency 1.3MHz PWM Operation
- High Efficiency Power Save Mode
- 100% Duty Cycle Low Dropout Operation
- Soft Start
- Output Over-Voltage Protection
- Dynamic Output Voltage Positioning
- 25 μ A Quiescent Current
- Thermal Shutdown and Short Circuit Protection
- Pb-Free 3x3mm 6-Lead MLP Package

Applications

- Pocket PCs, PDAs
- Cell Phones
- Battery-Powered Portable Devices
- Digital Cameras
- Hard Disk Drives
- Set-Top-Boxes
- Point-of-Load Power
- Notebook Computers
- Communications Equipment

Description

Designed for use in battery-powered applications, the FAN2001/FAN2002 is a high-efficiency, low-noise synchronous PWM current mode and Pulse Skip (Power Save) mode DC-DC converter. It can provide up to 1A of output current over a wide input range from 2.5V to 5.5V. The output voltage can be externally adjusted over a wide range of 0.8V to 5.5V by means of an external voltage divider.

At moderate and light loads, pulse skipping modulation is used. Dynamic voltage positioning is applied, and the output voltage is shifted 0.8% above nominal value for increased headroom during load transients. At higher loads the system automatically switches over to current mode PWM control, operating at 1.3 MHz. A current mode control loop with fast transient response ensures excellent line and load regulation. To achieve high efficiency and ensure long battery life, the quiescent current is reduced to 25 μ A in Power Save mode, and the supply current drops below 1 μ A in shut-down mode. The FAN2001/FAN2002 is available in a 3x3mm 6-lead MLP package.

Typical Application

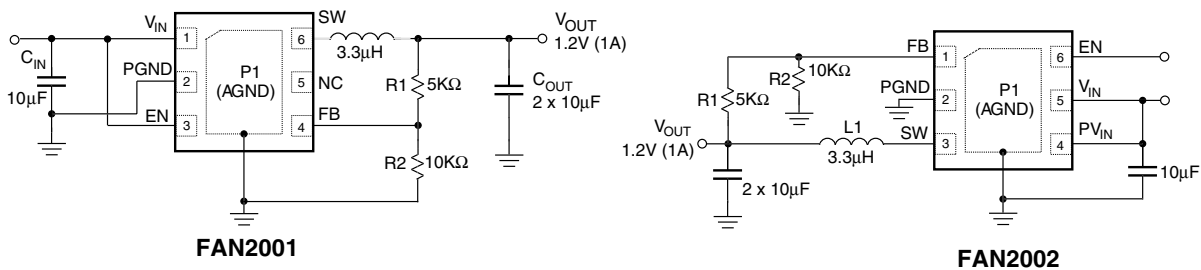

Figure 1. Typical Application

Pin Assignment

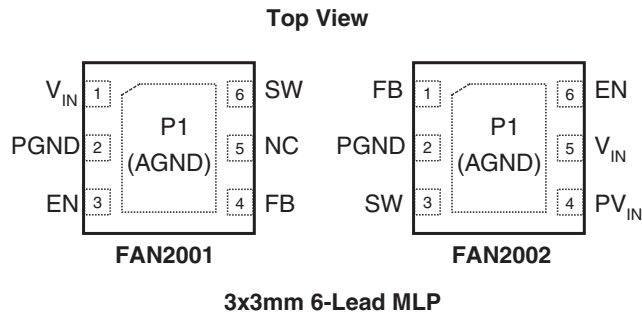

Figure 2. Pin Assignment

Pin Description

FAN2001 (3x3mm 6-Lead MLP)

Pin No.	Pin Name	Pin Description
P1	AGND	Analog Ground. P1 must be soldered to the PCB ground.
1	V _{IN}	Supply Voltage Input.
2	PGND	Power Ground. This pin is connected to the internal MOSFET switches. This pin must be externally connected to AGND.
3	EN	Enable Input. Logic high enables the chip and logic low disables the chip, reducing the supply current to less than 1μA. Do not float this pin.
4	FB	Feedback Input. Adjustable voltage option, connect this pin to the resistor divider.
5	NC	No Connection Pin.
6	SW	Switching Node. This pin is connected to the internal MOSFET switches.

FAN2002 (3x3mm 6-Lead MLP)

Pin No.	Pin Name	Pin Description
P1	AGND	Analog Ground. P1 must be soldered to the PCB ground.
1	FB	Feedback Input. Adjustable voltage option, connect this pin to the resistor divider.
2	PGND	Power Ground. This pin is connected to the internal MOSFET switches. This pin must be externally connected to AGND.
3	SW	Switching Node. This pin is connected to the internal MOSFET switches.
4	PV _{IN}	Supply Voltage Input. This pin is connected to the internal MOSFET switches.
5	V _{IN}	Supply Voltage Input.
6	EN	Enable Input. Logic high enables the chip and logic low disables the chip, reducing the supply current to less than 1μA. Do not float this pin.

Absolute Maximum Ratings (Note1)

Parameter	Min	Max	Unit
V_{IN}, PV_{IN}	-0.3	7	V
Voltage On Any Other Pin	-0.3	V_{IN}	V
Lead Soldering Temperature (10 seconds)		260	°C
Junction Temperature		150	°C
Storage Temperature	-65	150	°C
Thermal Resistance-Junction to Tab (θ_{JC}), 3x3mm 6-lead MLP (Note 2)		8	°C/W
Electrostatic Discharge Protection (ESD) Level (Note 3)	HBM	4	kV
	CDM	1	

Recommended Operating Conditions

Parameter	Min	Typ	Max	Unit
Supply Voltage Range	2.5		5.5	V
Output Voltage Range, Adjustable Version	0.8		V_{IN}	V
Output Current			1	A
Inductor (Note 4)		3.3		μ H
Input Capacitor (Note 4)		10		μ F
Output Capacitor (Note 4)		2 x 10		μ F
Operating Ambient Temperature Range	-40		+85	°C
Operating Junction Temperature Range	-40		+125	°C

Notes:

- Stresses above those listed under "Absolute Maximum Ratings" may cause permanent damage to the device. This is a stress rating only and functional operation of the device at these or any other conditions above those indicated in the operational section of this specification is not implied. Exposure to absolute maximum rating conditions for extended periods may affect device reliability. Absolute maximum ratings apply individually only, not in combination. Unless otherwise specified, all other voltages are referenced to AGND.
- Junction to ambient thermal resistance, θ_{JA} , is a strong function of PCB material, board thickness, thickness and number of copper planes, number of via used, diameter of via used, available copper surface, and attached heat sink characteristics.
- Using Mil Std. 883E, method 3015.7(Human Body Model) and EIA/JESD22C101-A (Charge Device Model).
- Refer to the applications section for further details.

Electrical Characteristics

$V_{IN} = V_{OUT} + 0.6V$ (min. 2.5V) to 5.5V, $I_{OUT} = 350mA$, $V_{OUT} = 1.2V$, $EN = V_{IN}$, $T_A = -40^{\circ}C$ to $+85^{\circ}C$, Unless otherwise noted. Typical values are at $T_A = 25^{\circ}C$.

Symbol	Parameter	Conditions	Min.	Typ.	Max.	Units	
V_{IN}	Input Voltage	$0\text{ mA} \leq I_{OUT} \leq 600\text{ mA}$	2.5		5.5	V	
		$0\text{ mA} \leq I_{OUT} \leq 1000\text{ mA}$	2.7		5.5	V	
I_Q	Quiescent Current	$I_{OUT} = 0\text{ mA}$, Device is not switching		20	35	μA	
		$I_{OUT} = 0\text{ mA}$, Device is switching (Note 5)	$R2 = 10\text{K}\Omega$		50		μA
			$R2 = 100\text{K}\Omega$		25		μA
	Shutdown Supply Current	$EN = \text{GND}$		0.1	1	μA	
	Undervoltage Lockout Threshold	V_{IN} Rising	1.9	2.1	2.3	V	
		Hysteresis		150		mV	
V_{ENH}	Enable High Input Voltage		1.3			V	
V_{ENL}	Enable Low Input Voltage				0.4	V	
I_{EN}	EN input bias current	$EN = V_{IN}$ or GND		0.01	0.1	μA	
R_{DS-ON}	PMOS On Resistance	$V_{IN} = V_{GS} = 5.5\text{V}$		250	350	m Ω	
		$V_{IN} = V_{GS} = 2.5\text{V}$		300	400		
	NMOS On Resistance	$V_{IN} = V_{GS} = 5.5\text{V}$		200	300	m Ω	
		$V_{IN} = V_{GS} = 2.5\text{V}$		250	350		
I_{LIM}	P-channel current limit	$2.5\text{V} < V_{IN} < 5.5\text{V}$	1300	1500	2000	mA	
	Oscillator frequency		1000	1300	1500	KHz	
I_{lkg_N}	N-channel leakage current	$V_{DS} = 5.5\text{V}$		0.1	1	μA	
I_{lkg_P}	P-channel leakage current	$V_{DS} = 5.5\text{V}$		0.1	1	μA	
	Line regulation	$I_{OUT} \leq 10\text{ mA}$		0.16		%/V	
	Load regulation	$350\text{ mA} \leq I_{OUT} \leq 1000\text{ mA}$		0.15		%	
V_{ref}	Reference Voltage			0.8		V	
	Output DC Voltage Accuracy (Note 6)	$0\text{ mA} \leq I_{OUT} \leq 1000\text{ mA}$	-3		+3	%	
	Over-Temperature Protection	PWM Mode Only $350\text{ mA} \leq I_{OUT} \leq 1000\text{ mA}$	Rising Temperature	150		$^{\circ}C$	
			Hysteresis	20		$^{\circ}C$	
	Start-Up Time	$I_{OUT} = 1000\text{ mA}$, $C_{OUT} = 20\text{ }\mu\text{F}$		800		μS	

Notes:

- Refer to the application section for further details.
- For output voltages $\leq 1.2V$ a $40\mu\text{F}$ output capacitor value is required to achieve a maximum output accuracy of 3% while operating in power save mode (PFM mode).

Typical Performance Characteristics

$T_A = 25^\circ\text{C}$, $C_{IN} = 10\mu\text{F}$, $C_{OUT} = 20\mu\text{F}$, $L = 3.3\mu\text{H}$, $R_2 = 10\text{K}\Omega$, unless otherwise noted.

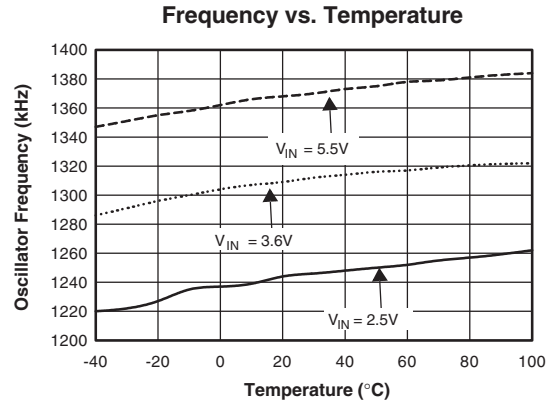
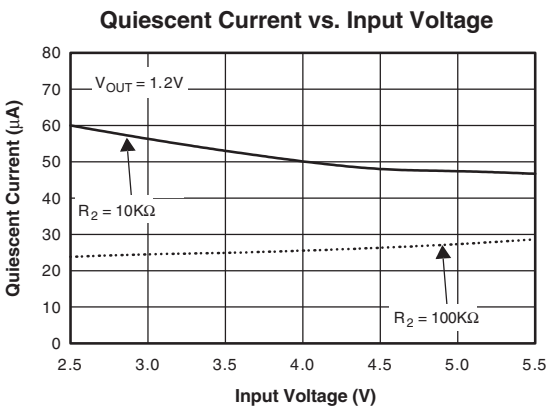
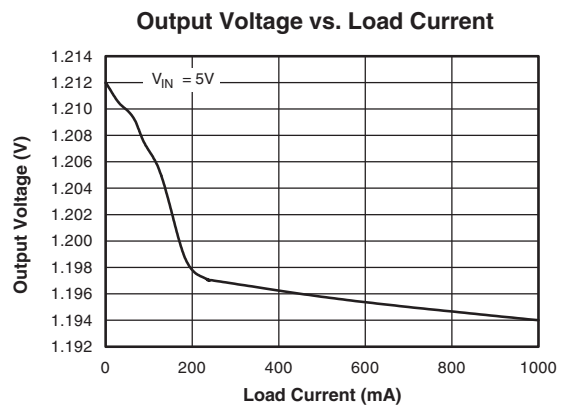
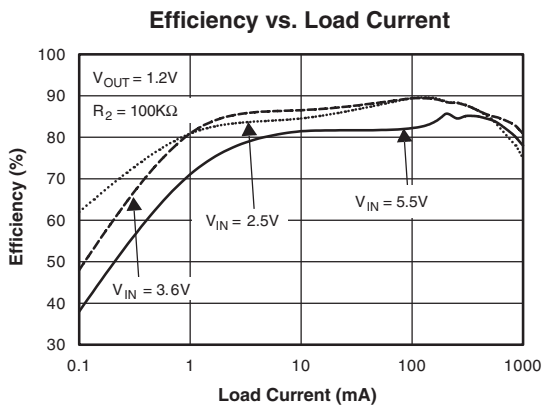
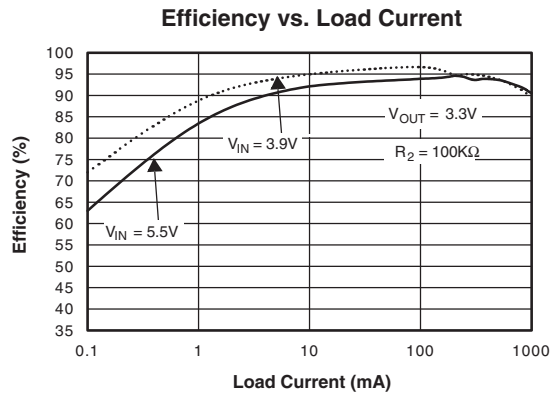
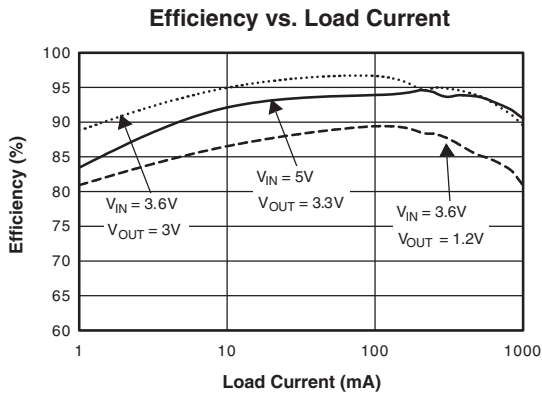

Typical Performance Characteristics (Contd.)

$T_A = 25^\circ\text{C}$, $C_{IN} = 10\mu\text{F}$, $C_{OUT} = 20\mu\text{F}$, $L = 3.3\mu\text{H}$, $R_2 = 10\text{K}\Omega$, unless otherwise noted.

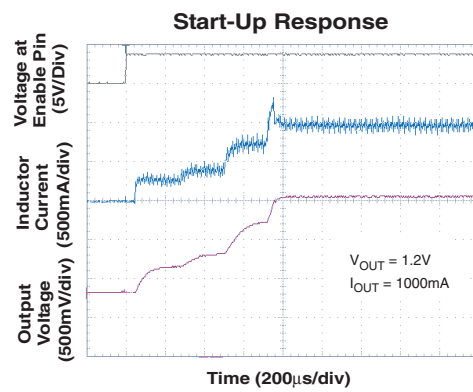
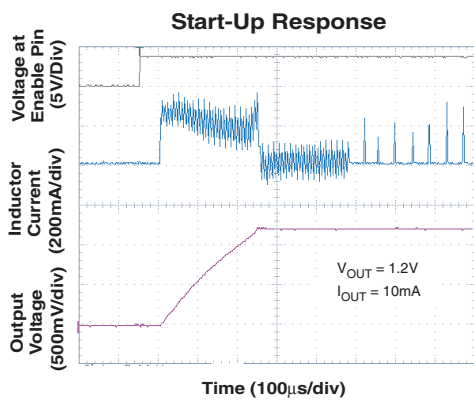
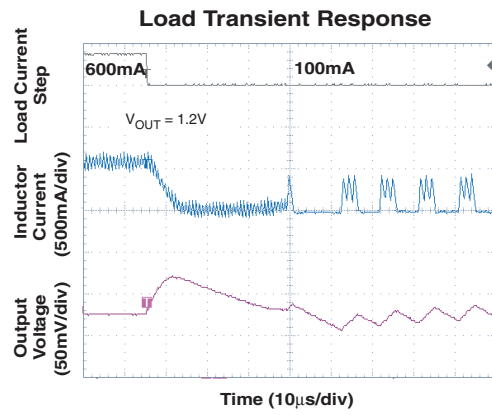
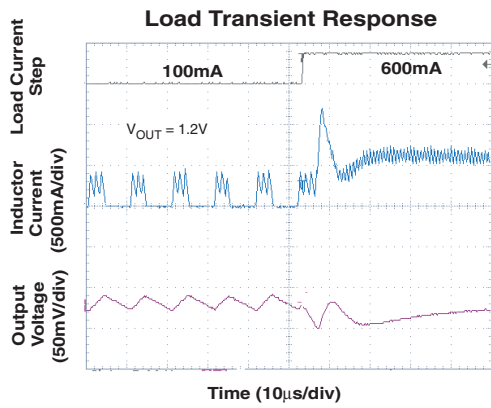
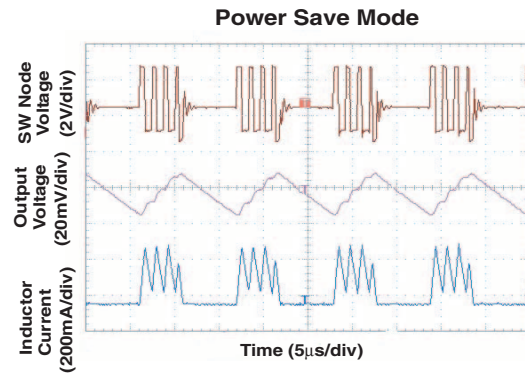
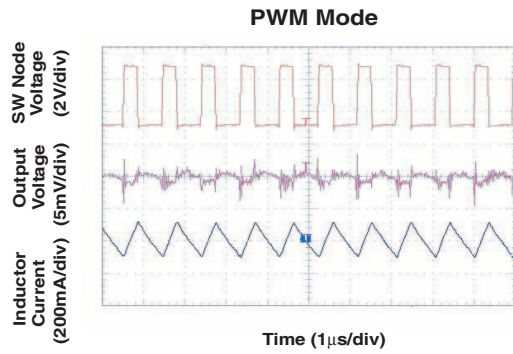

Block Diagram

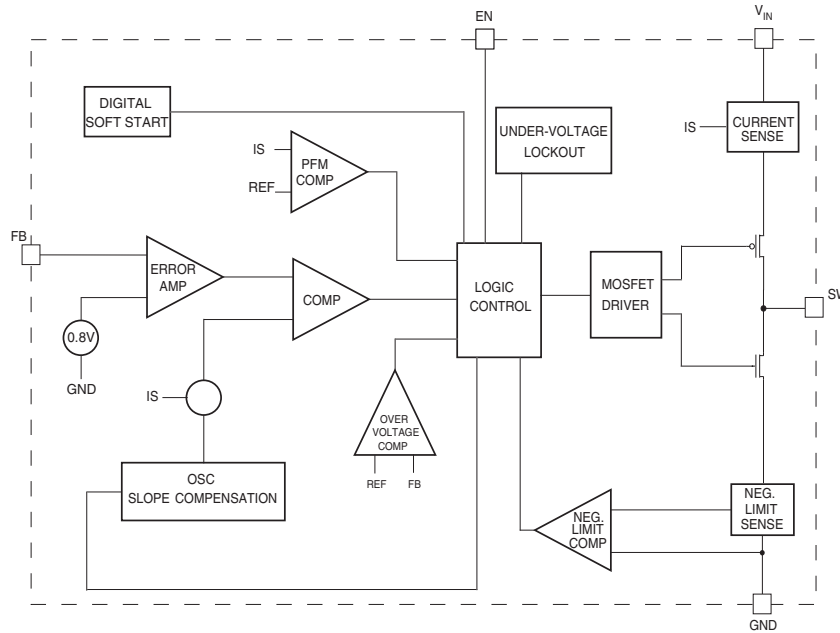

Figure 3. Block Diagram

Detailed Operation Description

The FAN2001/FAN2002 is a step-down converter operating in a current-mode PFM/PWM architecture with a typical switching frequency of 1.3MHz. At moderate to heavy loads, the converter operates in pulse-width-modulation (PWM) mode. At light loads the converter enters a power-save mode (PFM pulse skipping) to keep the efficiency high.

PWM Mode

In PWM mode, the device operates at a fixed frequency of 1.3MHz. At the beginning of each clock cycle, the P-channel transistor is turned on. The inductor current ramps up and is monitored via an internal circuit. The P-channel switch is turned off when the sensed current causes the PWM comparator to trip when the output voltage is in regulation or when the inductor current reaches the current limit (set internally to typically 1500mA). After a minimum dead time the N-channel transistor is turned on and the inductor current ramps down. As the clock cycle is completed, the N-channel switch is turned off and the next clock cycle starts.

PFM (Power Save) Mode

As the load current decreases and the inductor current reaches negative value, the converter enters pulse-frequency-modulation (PFM) mode. The transition point for the PFM mode is given by the equation:

$$I_{OUT} = V_{OUT} \times \frac{1 - (V_{OUT}/V_{IN})}{2 \times L \times f}$$

The typical output current when the device enters PFM mode is 150mA for input voltage of 3.6V and output voltage of 1.2V. In

PFM mode the device operates with a variable frequency and constant peak current, thus reducing the quiescent current to minimum. Consequently, the high efficiency is maintained at light loads. As soon as the output voltage falls below a threshold, set at 0.8% above the nominal value, the P-channel transistor is turned on and the inductor current ramps up. The P-channel switch turns off and the N-channel turns on as the peak inductor current is reached (typical 450mA).

The N-channel transistor is turned off before the inductor current becomes negative. At this time the P-channel is switched on again starting the next pulse. The converter continues these pulses until the high threshold (typical 1.6% above nominal value) is reached. A higher output voltage in PFM mode gives additional headroom for the voltage drop during a load transient from light to full load. The voltage overshoot during this load transient is also minimized due to active regulation during turn on of the N-channel rectifier switch. The device stays in sleep mode until the output voltage falls below the low threshold. The FAN2001/FAN2002 enters the PWM mode as soon as the output voltage can no longer be regulated in PFM with constant peak current.

100% Duty Cycle Operation

As the input voltage approaches the output voltage and the duty cycle exceeds the typical 95%, the converter turns the P-channel transistor continuously on. In this mode the output voltage is equal to the input voltage minus the voltage drop across the P-channel transistor:

$$V_{OUT} = V_{IN} - I_{LOAD} \times (R_{dsON} + R_L), \text{ where}$$

R_{dsON} = P-channel switch ON resistance

I_{LOAD} = Output current

R_L = Inductor DC resistance

UVLO and Soft Start

The reference and the circuit remain reset until the V_{IN} crosses its UVLO threshold.

The FAN2001/FAN2002 has an internal soft-start circuit that limits the in-rush current during start-up. This prevents possible voltage drops of the input voltage and eliminates the output voltage overshoot. The soft-start is implemented as a digital circuit increasing the switch current in four steps to the P-channel current limit (1500mA). Typical start-up time for a 20 μ F output capacitor and a load current of 1000mA is 800 μ s.

Short Circuit Protection

The switch peak current is limited cycle-by-cycle to a typical value of 1500mA. In the event of an output voltage short circuit, the device operates with a frequency of 400kHz and minimum duty cycle, therefore the average input current is typically 200mA.

Thermal Shutdown

When the die temperature exceeds 150°C, a reset occurs and will remain in effect until the die cools to 130°C, at that time the circuit will be allowed to restart.

Applications Information

Setting the Output Voltage

The internal reference is 0.8V (Typical). The output voltage is divided by a resistor divider, R1 and R2 to the FB pin. The output voltage is given by:

$$V_{OUT} = V_{REF} \left(1 + \frac{R_1}{R_2} \right)$$

Where $R_1 + R_2 < 800K\Omega$.

According to this equation, and assuming desired output voltage of 1.5096V, and given $R_2 = 10K\Omega$, the calculated value of R_1 is 8.87K Ω . If quiescent current is a key design parameter a higher value feedback resistor can be used (e.g. $R_2 = 100K\Omega$) and a small bypass capacitor of 10pF is required in parallel with the upper resistor as shown in Figure 4.

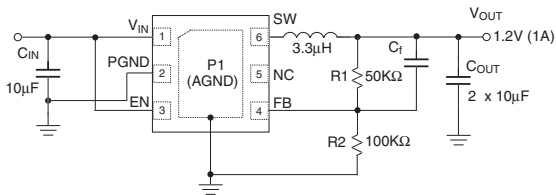

Figure 4. Setting the Output Voltage

Inductor Selection

The inductor parameters directly related to the device's performances are saturation current and dc resistance. The FAN2001/FAN2002 operates with a typical inductor value of 3.3 μ H. The lower the dc resistance, the higher the efficiency. For saturation current, the inductor should be rated higher than the maximum load current plus half of the inductor ripple current.

This is calculated as follows:

$$\Delta I_L = V_{OUT} \times \frac{1 - (V_{OUT}/V_{IN})}{L \times f}$$

where:

ΔI_L = Inductor Ripple Current

f = Switching Frequency

L = Inductor Value

Some recommended inductors are suggested in the table below:

Inductor Value	Vendor	Part Number
3.3 μ H	Panasonic	ELL6PM3R3N
3.3 μ H	Murata	LQS66C3R3M04

Table 1: Recommended Inductors

Capacitors Selection

For best performances, a low ESR input capacitor is required. A ceramic capacitor of at least 10 μ F, placed as close to the V_{IN} and AGND pins of the device is recommended. The output capacitor determines the output ripple and the transient response.

Capacitor Value	Vendor	Part Number
10 μ F	Taiyo Yuden	JMK212BJ106MG
		JMK316BJ106KL
	TDK	C2012X5ROJ106K
		C3216X5ROJ106M
Murata	GRM32ER61C106K	

Table 2: Recommended Capacitors

PCB Layout Recommendations

The recommended PCB layout is shown in Figures 5 and 6. The inherently high peak currents and switching frequency of power supplies require a careful PCB layout design.

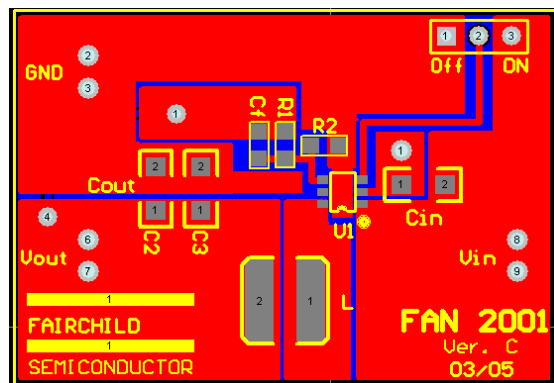

Figure 5. Recommended PCB Layout (FAN2001)

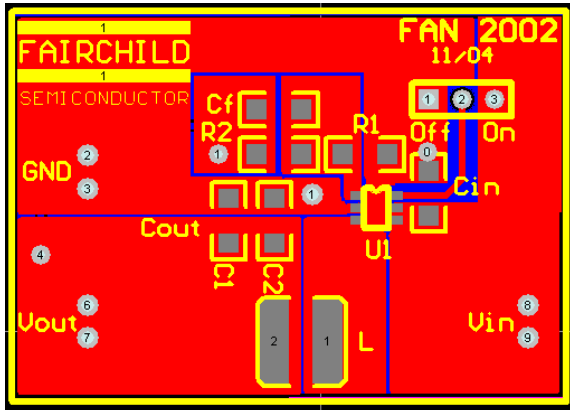

Figure 6. Recommended PCB Layout (FAN2002)

Therefore, use wide traces for high current paths and place the input capacitor, the inductor, and the output capacitor as close as possible to the integrated circuit terminals. In order to minimize voltage stress to the device resulting from ever present switching spikes, use an input bypass capacitor with low ESR. Note that the peak amplitude of the switching spikes depends upon the load current; the higher the load current, the higher the switching spikes. The resistor divider that sets the output voltage should be routed away from the inductor to avoid RF coupling. The ground plane at the bottom side of the PCB acts as an electromagnetic shield to reduce EMI.

For more board layout recommendations download the application note "PCB Grounding System and FAN2001/FAN2011 High Performance DC-DC Converters" (AN-42036).

Mechanical Dimensions

3x3mm 6-Lead MLP

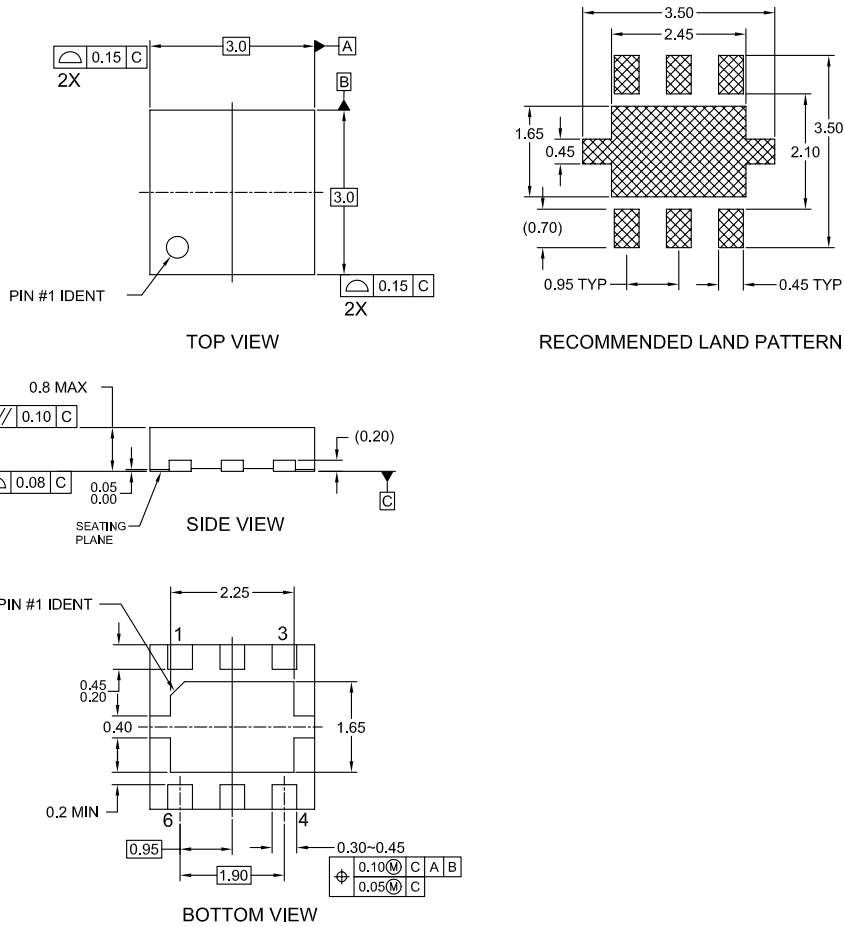

NOTES:

- A. CONFORMS TO JEDEC REGISTRATION MO-229, VARIATION WEEA, DATED 11/2001 EXCEPT FOR DAP EXTENSION TABS
- B. DIMENSIONS ARE IN MILLIMETERS.
- C. DIMENSIONS AND TOLERANCES PER ASME Y14.5M, 1994

Ordering Information

Product Number	Output Voltage	Package Type	Order Code
FAN2001	Adjustable	3x3mm 6-Lead MLP	FAN2001MPX
FAN2002	Adjustable	3x3mm 6-Lead MLP	FAN2002MPX

TRADEMARKS

The following are registered and unregistered trademarks Fairchild Semiconductor owns or is authorized to use and is not intended to be an exhaustive list of all such trademarks.

ACEx™	FAST®	IntelliMAX™	POP™	SPM™
ActiveArray™	FASTr™	ISOPLANAR™	Power247™	Stealth™
Bottomless™	FPS™	LittleFET™	PowerEdge™	SuperFET™
CoolFET™	FRFET™	MICROCOUPLER™	PowerSaver™	SuperSOT™-3
CROSSVOLT™	GlobalOptoisolator™	MicroFET™	PowerTrench®	SuperSOT™-6
DOME™	GTO™	MicroPak™	QFET®	SuperSOT™-8
EcoSPARK™	HiSeC™	MICROWIRE™	QS™	SyncFET™
E ² C MOS™	βC™	MSX™	QT Optoelectronics™	TinyLogic®
EnSigna™	i-Lo™	MSXPro™	Quiet Series™	TINYOPTO™
FACT™	ImpliedDisconnect™	OCX™	RapidConfigure™	TruTranslation™
FACT Quiet Series™		OCXPro™	RapidConnect™	UHC™
Across the board. Around the world.™		OPTOLOGIC®	μSerDes™	UltraFET®
The Power Franchise®		OPTOPLANAR™	SILENT SWITCHER®	UniFET™
Programmable Active Droop™		PACMAN™	SMART START™	VCX™

DISCLAIMER

FAIRCHILD SEMICONDUCTOR RESERVES THE RIGHT TO MAKE CHANGES WITHOUT FURTHER NOTICE TO ANY PRODUCTS HEREIN TO IMPROVE RELIABILITY, FUNCTION OR DESIGN. FAIRCHILD DOES NOT ASSUME ANY LIABILITY ARISING OUT OF THE APPLICATION OR USE OF ANY PRODUCT OR CIRCUIT DESCRIBED HEREIN; NEITHER DOES IT CONVEY ANY LICENSE UNDER ITS PATENT RIGHTS, NOR THE RIGHTS OF OTHERS.

LIFE SUPPORT POLICY

FAIRCHILD'S PRODUCTS ARE NOT AUTHORIZED FOR USE AS CRITICAL COMPONENTS IN LIFE SUPPORT DEVICES OR SYSTEMS WITHOUT THE EXPRESS WRITTEN APPROVAL OF FAIRCHILD SEMICONDUCTOR CORPORATION. As used herein:

- | | |
|---|---|
| <p>1. Life support devices or systems are devices or systems which, (a) are intended for surgical implant into the body, or (b) support or sustain life, or (c) whose failure to perform when properly used in accordance with instructions for use provided in the labeling, can be reasonably expected to result in significant injury to the user.</p> | <p>2. A critical component is any component of a life support device or system whose failure to perform can be reasonably expected to cause the failure of the life support device or system, or to affect its safety or effectiveness.</p> |
|---|---|

PRODUCT STATUS DEFINITIONS

Definition of Terms

Datasheet Identification	Product Status	Definition
Advance Information	Formative or In Design	This datasheet contains the design specifications for product development. Specifications may change in any manner without notice.
Preliminary	First Production	This datasheet contains preliminary data, and supplementary data will be published at a later date. Fairchild Semiconductor reserves the right to make changes at any time without notice in order to improve design.
No Identification Needed	Full Production	This datasheet contains final specifications. Fairchild Semiconductor reserves the right to make changes at any time without notice in order to improve design.
Obsolete	Not In Production	This datasheet contains specifications on a product that has been discontinued by Fairchild semiconductor. The datasheet is printed for reference information only.

Rev. 115

ON Semiconductor and  are trademarks of Semiconductor Components Industries, LLC dba ON Semiconductor or its subsidiaries in the United States and/or other countries. ON Semiconductor owns the rights to a number of patents, trademarks, copyrights, trade secrets, and other intellectual property. A listing of ON Semiconductor's product/patent coverage may be accessed at www.onsemi.com/site/pdf/Patent-Marking.pdf. ON Semiconductor reserves the right to make changes without further notice to any products herein. ON Semiconductor makes no warranty, representation or guarantee regarding the suitability of its products for any particular purpose, nor does ON Semiconductor assume any liability arising out of the application or use of any product or circuit, and specifically disclaims any and all liability, including without limitation special, consequential or incidental damages. Buyer is responsible for its products and applications using ON Semiconductor products, including compliance with all laws, regulations and safety requirements or standards, regardless of any support or applications information provided by ON Semiconductor. "Typical" parameters which may be provided in ON Semiconductor data sheets and/or specifications can and do vary in different applications and actual performance may vary over time. All operating parameters, including "Typicals" must be validated for each customer application by customer's technical experts. ON Semiconductor does not convey any license under its patent rights nor the rights of others. ON Semiconductor products are not designed, intended, or authorized for use as a critical component in life support systems or any FDA Class 3 medical devices or medical devices with a same or similar classification in a foreign jurisdiction or any devices intended for implantation in the human body. Should Buyer purchase or use ON Semiconductor products for any such unintended or unauthorized application, Buyer shall indemnify and hold ON Semiconductor and its officers, employees, subsidiaries, affiliates, and distributors harmless against all claims, costs, damages, and expenses, and reasonable attorney fees arising out of, directly or indirectly, any claim of personal injury or death associated with such unintended or unauthorized use, even if such claim alleges that ON Semiconductor was negligent regarding the design or manufacture of the part. ON Semiconductor is an Equal Opportunity/Affirmative Action Employer. This literature is subject to all applicable copyright laws and is not for resale in any manner.

PUBLICATION ORDERING INFORMATION

LITERATURE FULFILLMENT:

Literature Distribution Center for ON Semiconductor
19521 E. 32nd Pkwy, Aurora, Colorado 80011 USA
Phone: 303-675-2175 or 800-344-3860 Toll Free USA/Canada
Fax: 303-675-2176 or 800-344-3867 Toll Free USA/Canada
Email: orderlit@onsemi.com

N. American Technical Support: 800-282-9855 Toll Free
USA/Canada
Europe, Middle East and Africa Technical Support:
Phone: 421 33 790 2910
Japan Customer Focus Center
Phone: 81-3-5817-1050

ON Semiconductor Website: www.onsemi.com
Order Literature: <http://www.onsemi.com/orderlit>
For additional information, please contact your local
Sales Representative

Mouser Electronics

Authorized Distributor

Click to View Pricing, Inventory, Delivery & Lifecycle Information:

[ON Semiconductor:](#)

[FAN2002MPX](#)