

### ●Applications

- Optical control equipment
- Cameras

### ●Features

- 1) Ultra-small.
- 2) Minimal influence from stray light.
- 3) Low collector-emitter saturation voltage.

### ●Outline



### ●Dimensions (Unit : mm)

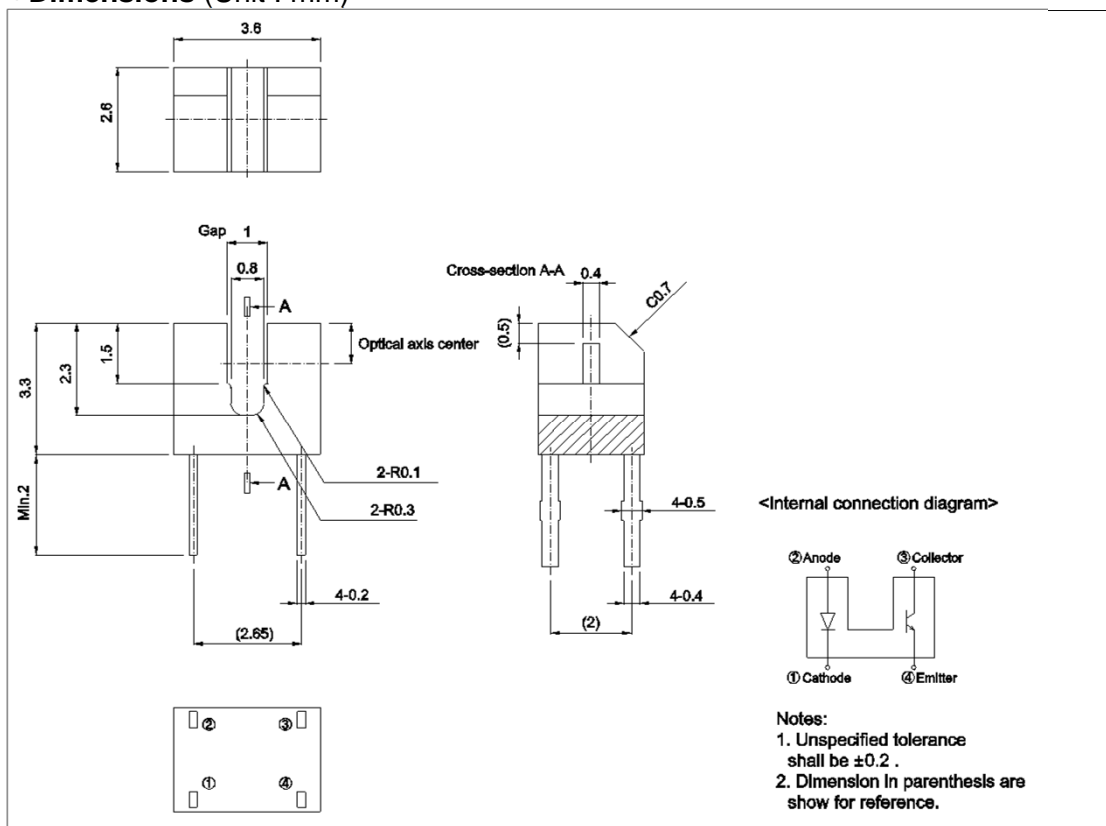

### ●Absolute maximum ratings ( $T_a = 25^\circ\text{C}$ )

Parameter		Symbol	Value	Unit
Input (LED)	Forward current	$I_F$	50	mA
	Reverse voltage	$V_R$	5	V
	Power dissipation	$P_D$	80	mW
Output (photo-transistor)	Collector-emitter voltage	$V_{CEO}$	30	V
	Emitter-collector voltage	$V_{ECO}$	4.5	V
	Collector current	$I_C$	30	mA
	Collector power dissipation	$P_C$	80	mW
Operating temperature		$T_{opr}$	-25 to +85	$^\circ\text{C}$
Storage temperature		$T_{stg}$	-40 to +100	$^\circ\text{C}$

**●Electrical and optical characteristics (T<sub>a</sub> = 25°C)**

Parameter		Symbol	Conditions	Values			Unit
				Min.	Typ.	Max.	
Input characteristics	Forward voltage	V <sub>F</sub>	I <sub>F</sub> =50mA	-	1.3	1.6	V
	Reverse current	I <sub>R</sub>	V <sub>R</sub> =5V	-	-	10	μA
Output characteristics	Dark current	I <sub>CEO</sub>	V <sub>CE</sub> =10V	-	-	0.5	μA
	Peak sensitivity wavelength	λ <sub>p</sub>	-	-	800	-	nm
Transfer characteristics	Collector current	I <sub>C1</sub>	V <sub>CE</sub> =5V, I <sub>F</sub> =20mA	0.7	-	-	mA
		I <sub>C2</sub>	V <sub>CE</sub> =5V, I <sub>F</sub> =5mA	0.2	-	-	mA
	Collector-emitter saturation voltage	V <sub>CE(sat)</sub>	I <sub>F</sub> =20mA, I <sub>C</sub> =0.3mA	-	-	0.3	V
	Response time	tr·tf	V <sub>CC</sub> =5V, I <sub>F</sub> =20mA, R <sub>L</sub> =100Ω	-	10	-	μs
Infrared light emitter diode	Cut-off frequency	f <sub>c</sub>	I <sub>F</sub> =50mA	-	1	-	MHz
	Peak light emitting wavelength	λ <sub>p</sub>	* Non-coherent Infrared light emitting diode used.	-	950	-	nm
Photo transistor	Response time	tr·tf	V <sub>CC</sub> =5V, I <sub>C</sub> =1mA, R <sub>L</sub> =100Ω *This product is not designed to be protected against electromagnetic wave.	-	10	-	μs
	Maximum sensitivity wavelength	λ <sub>p</sub>	-	-	800	-	nm

●Electrical and optical characteristics curves

Fig.1 Relative Output Current vs.Distance (I)

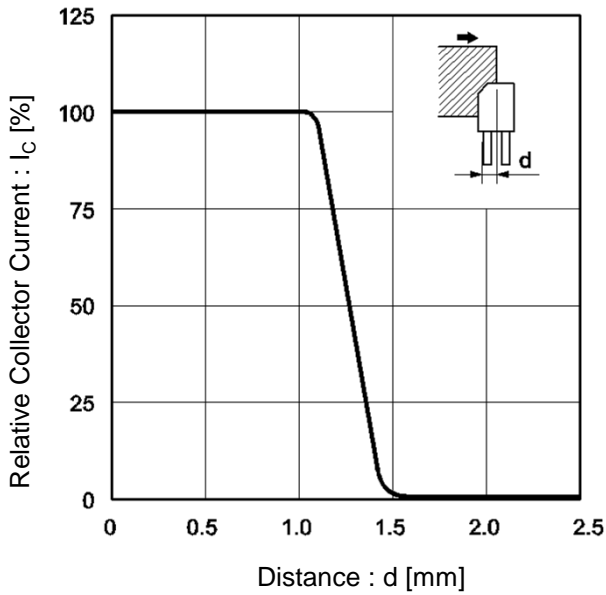

Fig.2 Relative Output Current vs.Distance (II)

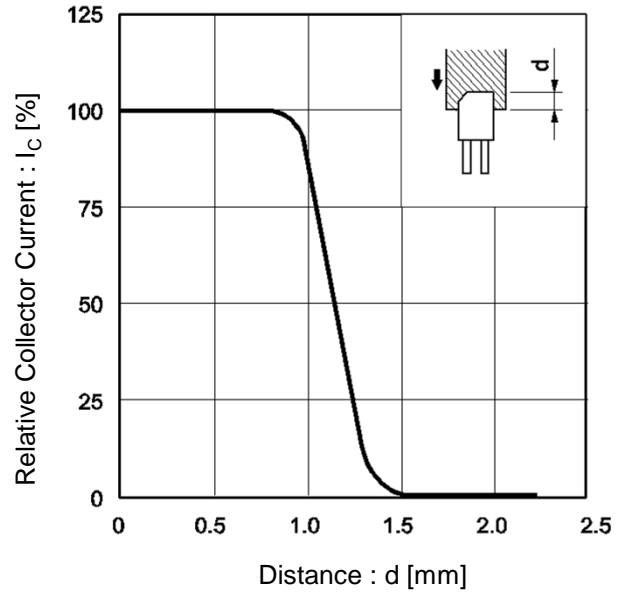

Fig.3 Forward Current Falloff

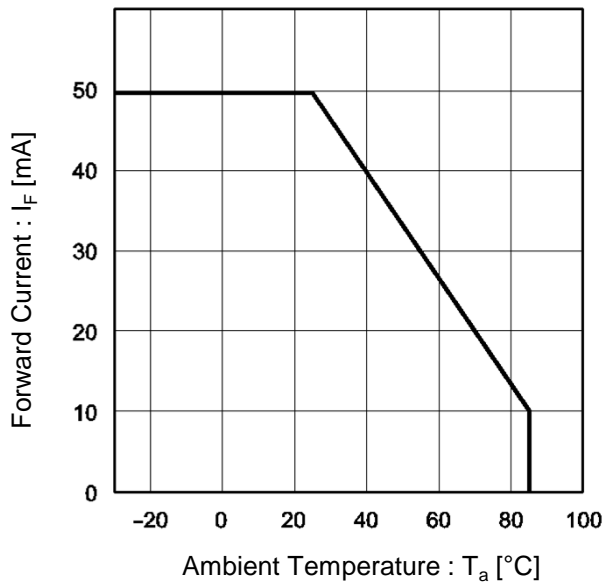
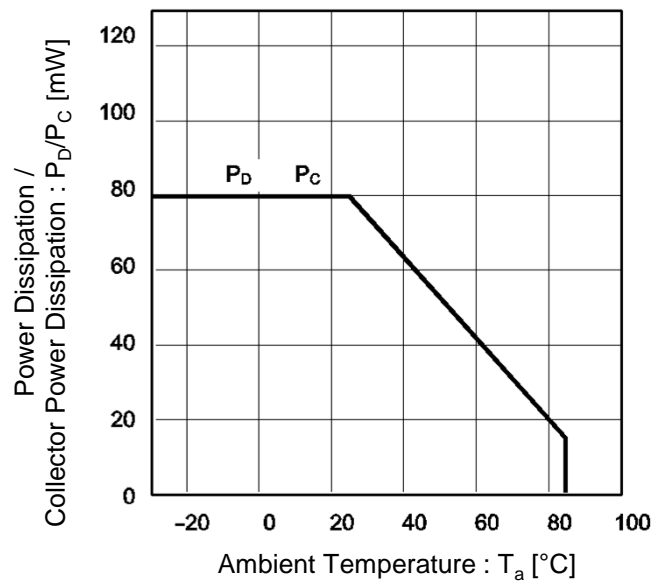

Fig.4 Power Dissipation / Collector Power Dissipation vs. Ambient Temperature



●Electrical and optical characteristics curves

Fig.5 Forward Current vs. Forward Voltage

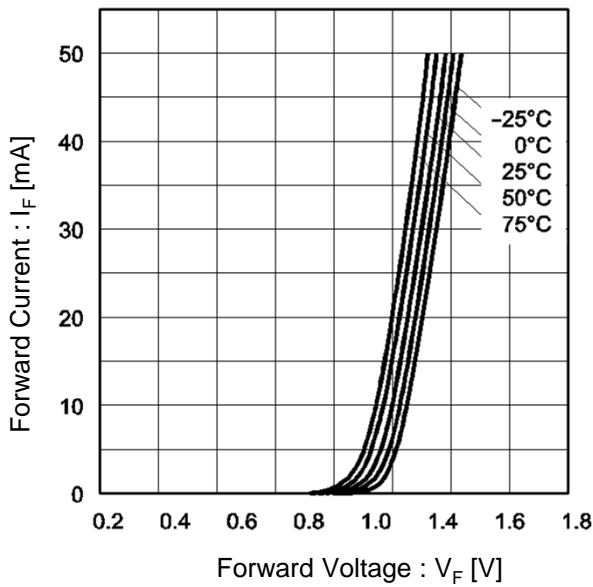

Fig.6 Collector Current vs. Forward Current

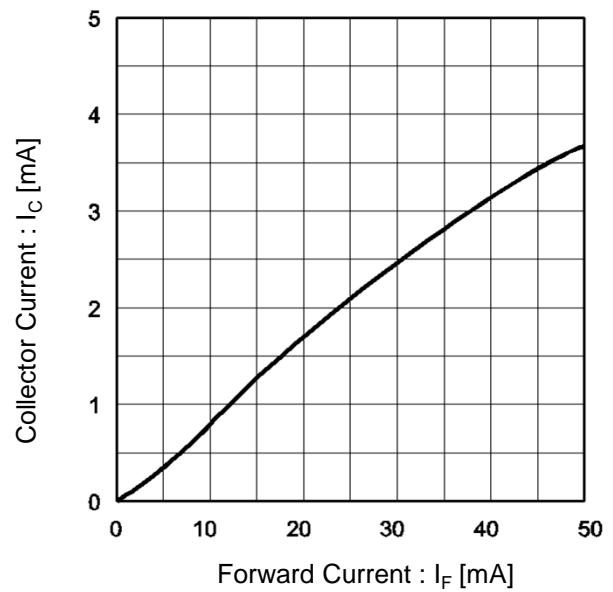

Fig.7 Relative Output vs. Ambient Temperature

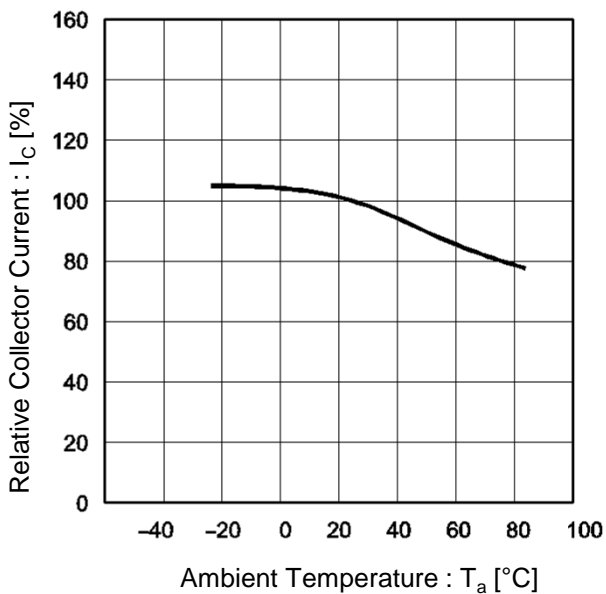
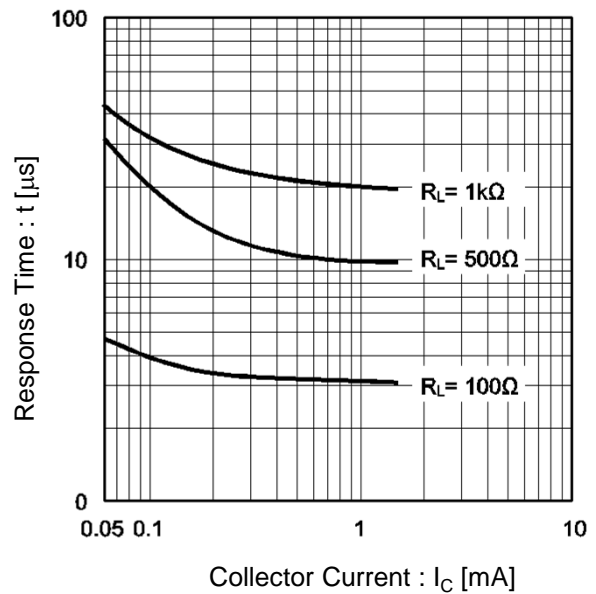

Fig.8 Response Time vs. Collector Current



●Electrical and optical characteristics curves

Fig.9 Dark Current vs. Ambient Temperature

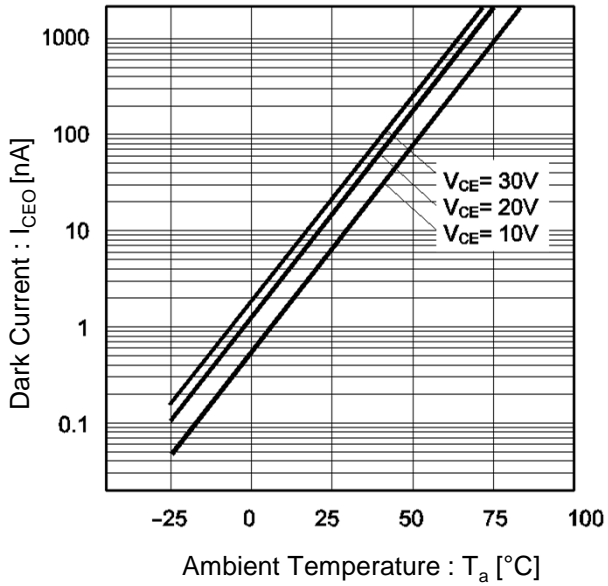

Fig.10 Output Characteristics

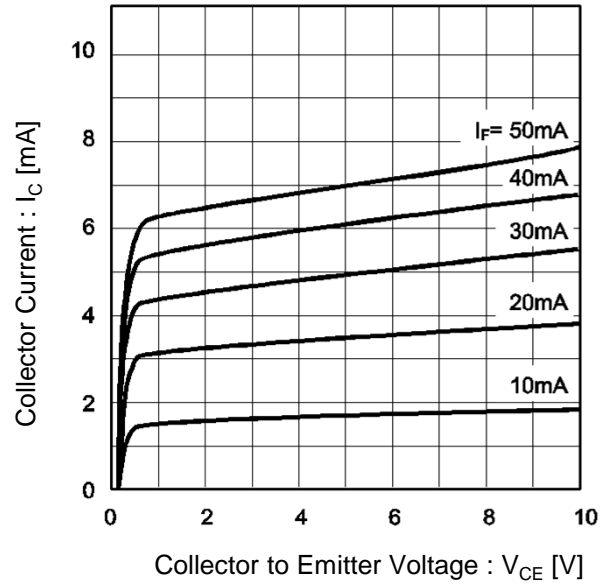
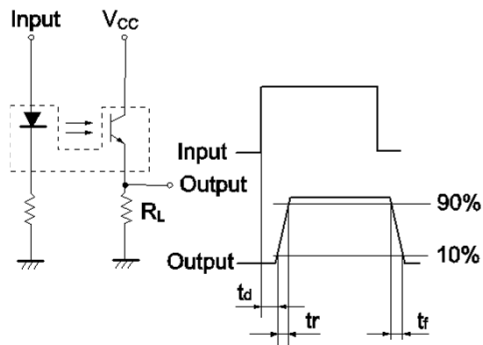

Fig.11 Response Time Measurement Circuit



$t_d$  : Delay time  
 $t_r$  : Rise time (time for output current to rise from 10% to 90% of peak current)  
 $t_f$  : Fall time (time for output current to fall from 90% to 10% of peak current)

## Notes

- 1) The information contained herein is subject to change without notice.
- 2) Before you use our Products, please contact our sales representative and verify the latest specifications :
- 3) Although ROHM is continuously working to improve product reliability and quality, semiconductors can break down and malfunction due to various factors.  
Therefore, in order to prevent personal injury or fire arising from failure, please take safety measures such as complying with the derating characteristics, implementing redundant and fire prevention designs, and utilizing backups and fail-safe procedures. ROHM shall have no responsibility for any damages arising out of the use of our Products beyond the rating specified by ROHM.
- 4) Examples of application circuits, circuit constants and any other information contained herein are provided only to illustrate the standard usage and operations of the Products. The peripheral conditions must be taken into account when designing circuits for mass production.
- 5) The technical information specified herein is intended only to show the typical functions of and examples of application circuits for the Products. ROHM does not grant you, explicitly or implicitly, any license to use or exercise intellectual property or other rights held by ROHM or any other parties. ROHM shall have no responsibility whatsoever for any dispute arising out of the use of such technical information.
- 6) The Products are intended for use in general electronic equipment (i.e. AV/OA devices, communication, consumer systems, gaming/entertainment sets) as well as the applications indicated in this document.
- 7) The Products specified in this document are not designed to be radiation tolerant.
- 8) For use of our Products in applications requiring a high degree of reliability (as exemplified below), please contact and consult with a ROHM representative : transportation equipment (i.e. cars, ships, trains), primary communication equipment, traffic lights, fire/crime prevention, safety equipment, medical systems, servers, solar cells, and power transmission systems.
- 9) Do not use our Products in applications requiring extremely high reliability, such as aerospace equipment, nuclear power control systems, and submarine repeaters.
- 10) ROHM shall have no responsibility for any damages or injury arising from non-compliance with the recommended usage conditions and specifications contained herein.
- 11) ROHM has used reasonable care to ensure the accuracy of the information contained in this document. However, ROHM does not warrant that such information is error-free, and ROHM shall have no responsibility for any damages arising from any inaccuracy or misprint of such information.
- 12) Please use the Products in accordance with any applicable environmental laws and regulations, such as the RoHS Directive. For more details, including RoHS compatibility, please contact a ROHM sales office. ROHM shall have no responsibility for any damages or losses resulting from non-compliance with any applicable laws or regulations.
- 13) When providing our Products and technologies contained in this document to other countries, you must abide by the procedures and provisions stipulated in all applicable export laws and regulations, including without limitation the US Export Administration Regulations and the Foreign Exchange and Foreign Trade Act.
- 14) This document, in part or in whole, may not be reprinted or reproduced without prior consent of ROHM.



Thank you for your accessing to ROHM product informations.  
More detail product informations and catalogs are available, please contact us.

## ROHM Customer Support System

<http://www.rohm.com/contact/>

# Mouser Electronics

Authorized Distributor

Click to View Pricing, Inventory, Delivery & Lifecycle Information:

[ROHM Semiconductor:](#)

[RPI-121](#)