

THIS DOCUMENT IS THE PROPERTY OF  
KEYSTONE ELECTRONICS CORP. AND  
SHALL NOT BE REPRODUCED, DISTRIBUTED  
OR USED AS A BASIS FOR MANUFACTURE  
WITHOUT PRIOR WRITTEN PERMISSION  
FROM KEYSTONE ELECTRONICS CORP.

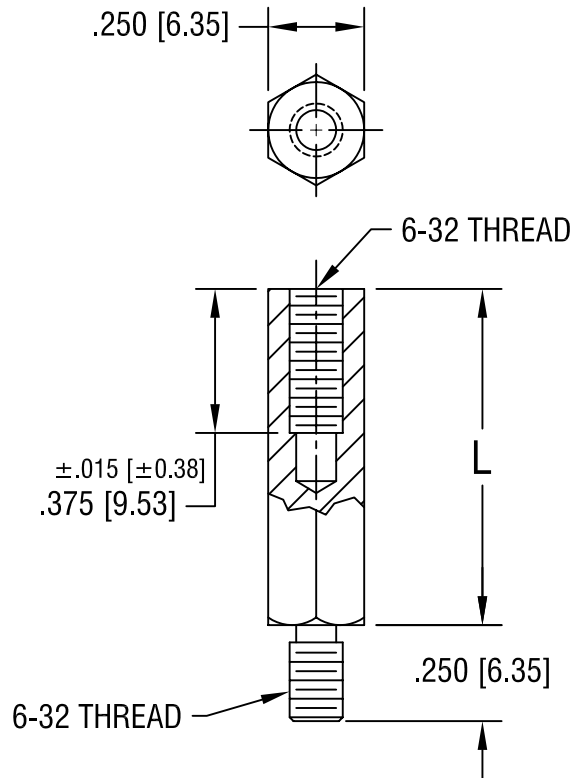

PART NO.	'L' DIM.
2120	.500 [12.70]
2121	.625 [15.88]
2122	.750 [19.05]
2123	.875 [22.23]
2124	1.000 [25.40]
2125	1.125 [28.58]

**KEYSTONE ELECTRONICS CORP.**

ASTORIA, N.Y. 11105-2017

PART NAME

HEX M/F STANDOFF

MATERIAL

STAINLESS STEEL

FINISH

-

DRN BY

BOONE

DATE

3.4.98

APP'D

LN

SCALE

2X

TOLERANCES

INCH

[MM]

DECIMAL ±.005 [± 0.15]

ANGULAR ± 1°  
UNLESS OTHERWISE SPECIFIED

CODE

C/M

DWG NO.

2120-2125

DATE	DESCRIPTION	REV.

# Mouser Electronics

Authorized Distributor

Click to View Pricing, Inventory, Delivery & Lifecycle Information:

[Keystone Electronics:](#)

[2120](#)