

Type 3522 Series

Key Features

3 Watts at 70°C

Small size to power ratio

Supplied on tape

Value marked on resistor

Available via distribution

500 volt maximum overload

250 volt working voltage

Terminal finish matte Sn over Ni



TE Connectivity is pleased to introduce this low cost high power device, suitable for auto placement in volume and for most applications, including high frequency operations, owing to the short lead structure. Supplied as standard on 7 inch Reels of 2000 pieces per reel.

Characteristics – Electrical

Power rating at 70°C	3W
Rated current (Jumper)	2.5A
Max. overload current (Jumper)	10A
Max working voltage	250V
Max overload voltage	500V
Dielectric withstand voltage	500V
Temperature range	-55°C ~ +155°C
Ambient temperature	70°C

* Rated continuous working voltage (RCWV) shall be determined from

RCWV = Rated Power x Resistance Value, or Maximum RCWV listed above, whichever is less

**Recommended Circuit Board Design - If this device is anticipated to run at full continuous power then action to improve the cooling should be taken. This can be a metal substrate, copper pad left under the chip, an opening in the PCB or enlarged silver conductor pads each end.

Power derating curve

For resistors operated in ambient temperatures above 70°C, power rating must be derated in accordance with this curve.

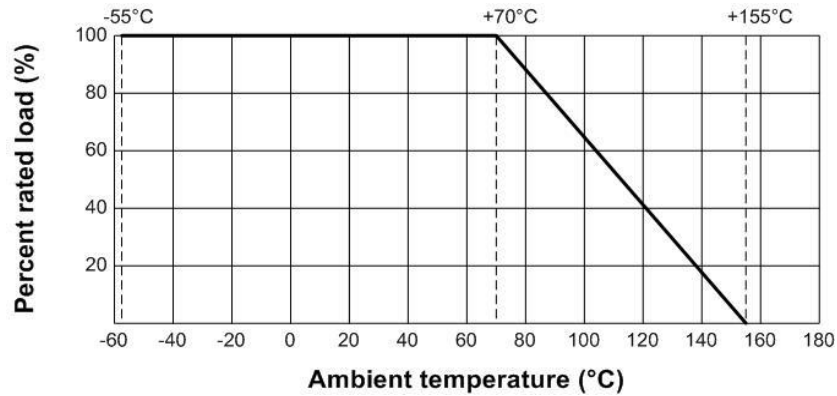

Construction and dimensions

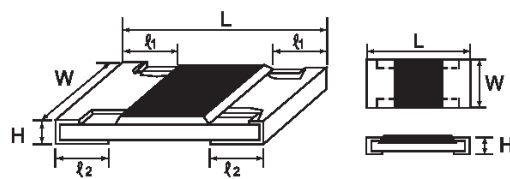
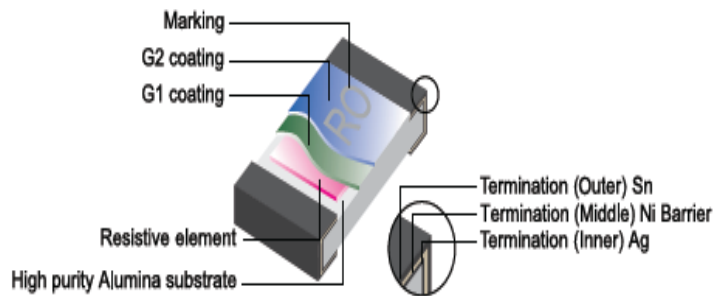

$L \pm 0.10$	$W \pm 0.15$	$H \pm 0.10$	$l1 \pm 0.25$	$l2 \pm 0.20$
6.35	3.20	1.10	0.60	1.80

Power rating @70°C	Tolerance %	Resistance Range	Standard series
3W	Jumper	<50mΩ	
	± 1%	10Ω - 1MΩ	E96
	± 5%	10Ω - 10MΩ	E24

Marking:

Marking for E-96 series in 2512 size: 4 digit marking

First three digits are significant figures of resistance and the fourth digit represents the number of following zeros

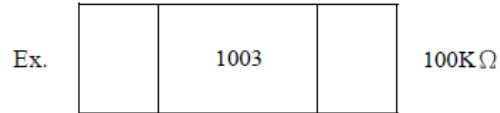

Marking for E-24 series in 2512 size: 3 digit marking

First two digits are significant figures, and the third digit represents the number of zeros

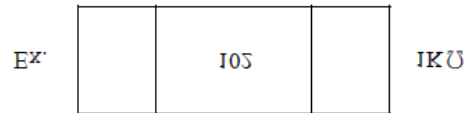

Packing specification:

Taping dimensions (mm)

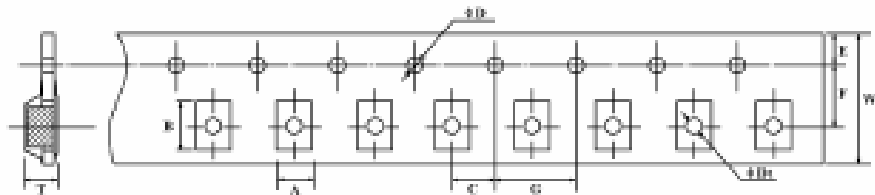

A	B	C	$\varnothing D$	E	F	G	W	$\varnothing D1$	T
± 0.20	± 0.20	± 0.05	+0.1 -0	± 0.10	± 0.05	± 0.1	± 0.20	+0.1 -0	± 0.1
3.5	6.7	2.0	1.5	1.75	5.5	4.0	12	1.5	1.35

Peeling strength of Top Cover Tape

Test Condition 0.1 to 0.7 N at a peel-off speed of 300mm / min.

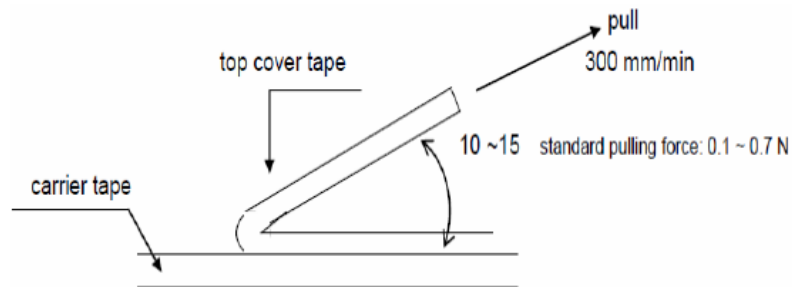

Reel dimension (mm)

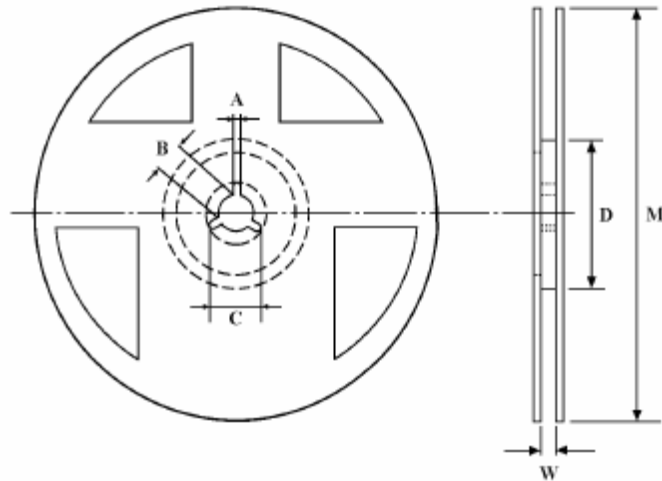

Qty / Reel	A ±0.5	B ±0.5	C ±0.5	D ±1	M ±2	W ±1
2000	2	13.5	21	60	178	13.8

Handling Recommendations

When flow soldering - the land width must be smaller than the Chip Resistor width to properly control the solder application. Generally, the land width can be Chip Resistor width (W) x 0.7 to 0.8. When reflow soldering – solder application amount can be adjusted. Thus the land width can be set to W x 1.0 to 1.3.

How To Order

3522	1K0	F	T
Common Part	Resistance Value	Tolerance	Pack Style
3522	1 ohm 1R0 1K ohm 1000 ohms 1K0 1 Meg ohm 1000000 ohms 1M0	F – 1% J – 5%	T – 2000 reel

Mouser Electronics

Authorized Distributor

Click to View Pricing, Inventory, Delivery & Lifecycle Information:

TE Connectivity:

[352210KJT](#) [35221M0FT](#) [352210KFT](#) [352210RFT](#) [35221K0FT](#) [35221K1FT](#) [3522820KJT](#) [35223K3FT](#) [35222K4FT](#)
[3522150RFT](#) [3522180KFT](#) [3522560KFT](#) [3522150KFT](#) [3522180KJT](#) [35221K2JT](#) [3522200RFT](#) [3522200KFT](#)
[35222M7JT](#) [352213KFT](#) [3522240RFT](#) [352282KJT](#) [35222K7JT](#) [35227K5FT](#) [3522120RJT](#) [3522120KFT](#) [35222K7FT](#)
[35224K3FT](#) [3522270RJT](#) [3522300RFT](#) [352233RFT](#) [352218RJT](#) [3522820KFT](#) [352233RJT](#) [35223K9JT](#)
[352268KFT](#) [352218RFT](#) [3522680KJT](#) [352220RFT](#) [3522150KJT](#) [352220KFT](#) [35221K3FT](#) [352236KFT](#) [352212RJT](#)
[352222KFT](#) [3522820RJT](#) [35223R9JT](#) [3522470RFT](#) [352256RJT](#) [3522330KFT](#) [352251KFT](#) [3522510KFT](#)
[3522180RJT](#) [35221R2JT](#) [3522470KFT](#) [35225K6FT](#) [35221M8JT](#) [3522360KFT](#) [3522110RFT](#) [352212KFT](#)
[352282RFT](#) [352247KFT](#) [35223K0FT](#) [352236RFT](#) [352213RFT](#) [352222RFT](#) [352215KJT](#) [352230KFT](#) [35221K8JT](#)
[35221K2FT](#) [3522270RFT](#) [35223M9JT](#) [3522130KFT](#) [35224K7FT](#) [35223K3JT](#) [352247KJT](#) [3522270KFT](#) [352268RFT](#)
[3522110KFT](#) [352291RFT](#) [35224K7JT](#) [35221K5FT](#) [3522910RFT](#) [35228R2JT](#) [352215RFT](#) [352239RJT](#)
[3522390RJT](#) [352227RJT](#) [3522390KJT](#) [352215RJT](#) [352282RJT](#) [352243KFT](#) [3522390KFT](#) [3522160RFT](#)
[35221K6FT](#) [3522220KJT](#) [352222KJT](#) [352251RFT](#) [35226M8JT](#) [3522620KFT](#) [35223K6FT](#)