

- 1 DOUBLE BAR POLARIZATION SLOTS.
- 2 CENTER POLARIZATION SLOT.
- 3 FOR 10 POSN ASSEMBLY, SLOT OMITTED IN THIS LOCATION.
- 4 NUMBER 1 POSITION INDICATOR.
- 5 DATUMS -U- AND -V- TO BE ESTABLISHED BY CUSTOMER.
- 6 HOUSING: GLASS FILLED NYLON OR PBT, BLACK, UL 94V-0 RATED. POSTS: BRASS.
- 7 POSTS: GOLD FLASH OVER PALLADIUM-NICKEL PLATE, .000015 MIN TOTAL ON THE MATING SURFACES, .000100 MIN TIN PLATE ON THE SOLDER-TAILS, .000050 MIN NICKEL UNDERPLATE ON THE ENTIRE POST. -OR- .000015 MIN GOLD PLATE ON THE MATING SURFACES, .000100 MIN TIN PLATE ON THE SOLDER-TAILS, .000050 MIN NICKEL UNDERPLATE ON THE ENTIRE POST.
- 8 STANDOFFS: ALL POSITION SIZES-2 LOCATED AT ENDS OF HOUSING. 20 THRU 34 POSITION SIZES-1 ADDITIONAL STANDOFF CENTERED ON HOUSING. 40 THRU 50 POSITION SIZES- 2 ADDITIONAL STANDOFFS EVENLY SPACED WITHIN REMAINING LENGTH OF HOUSING.

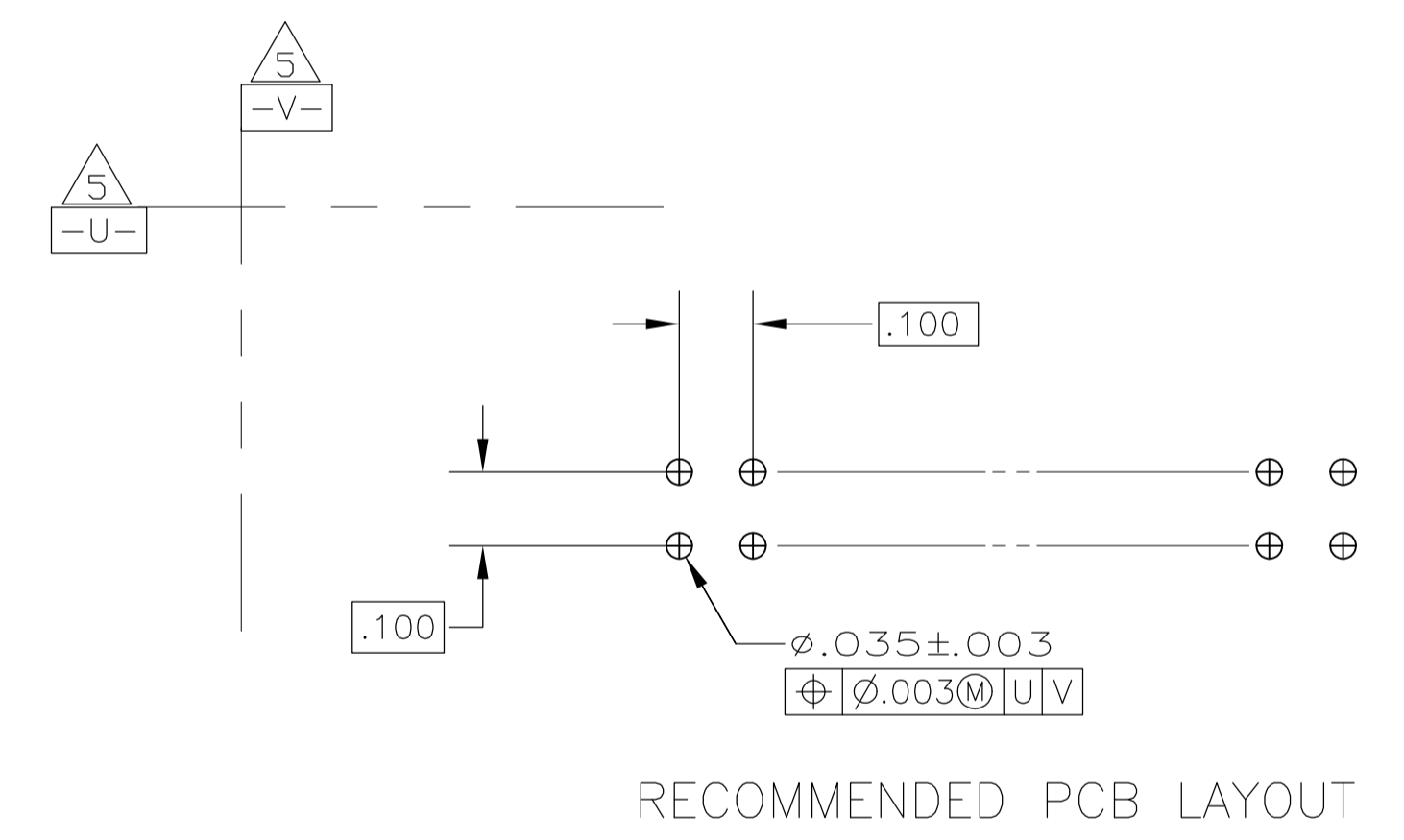
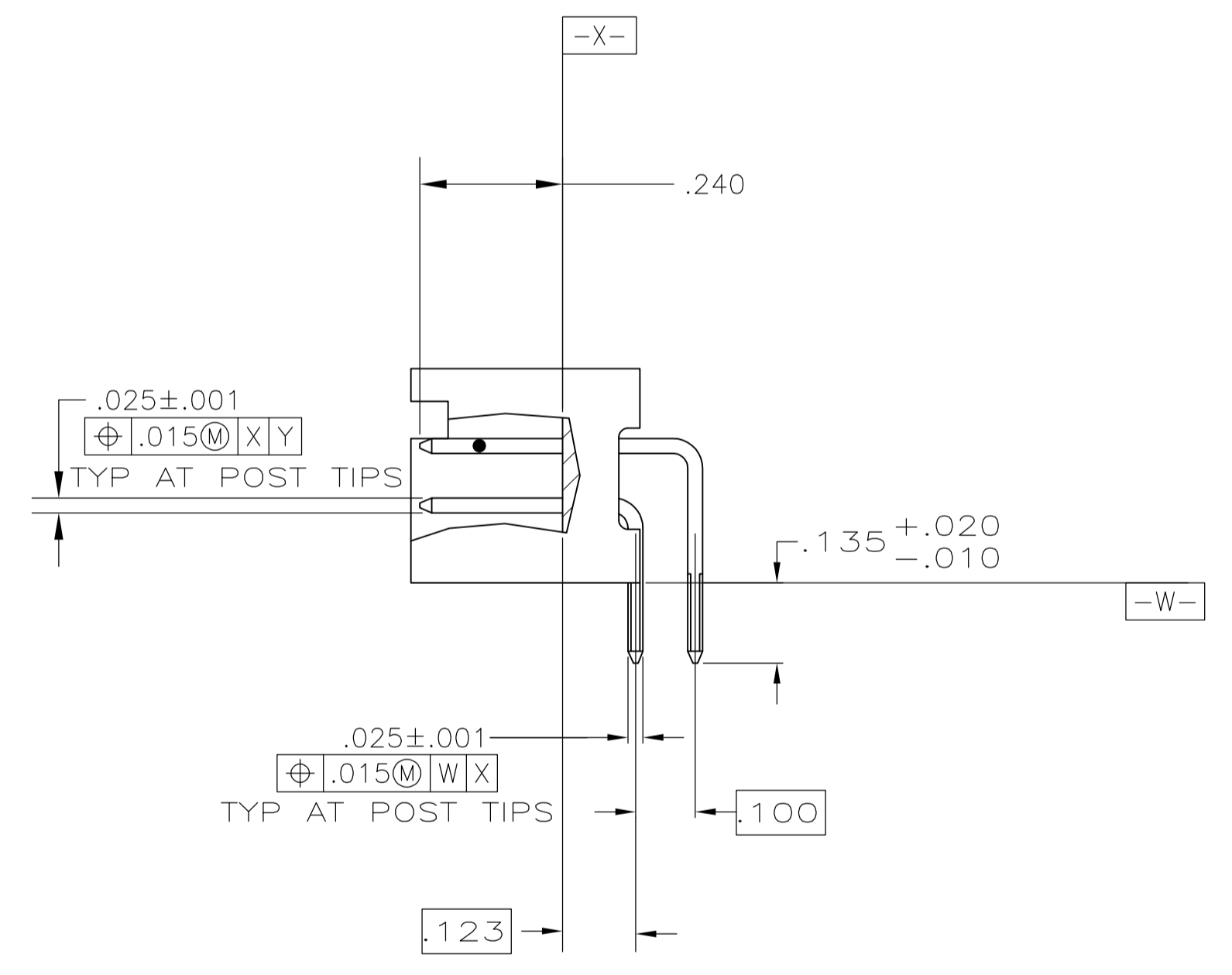
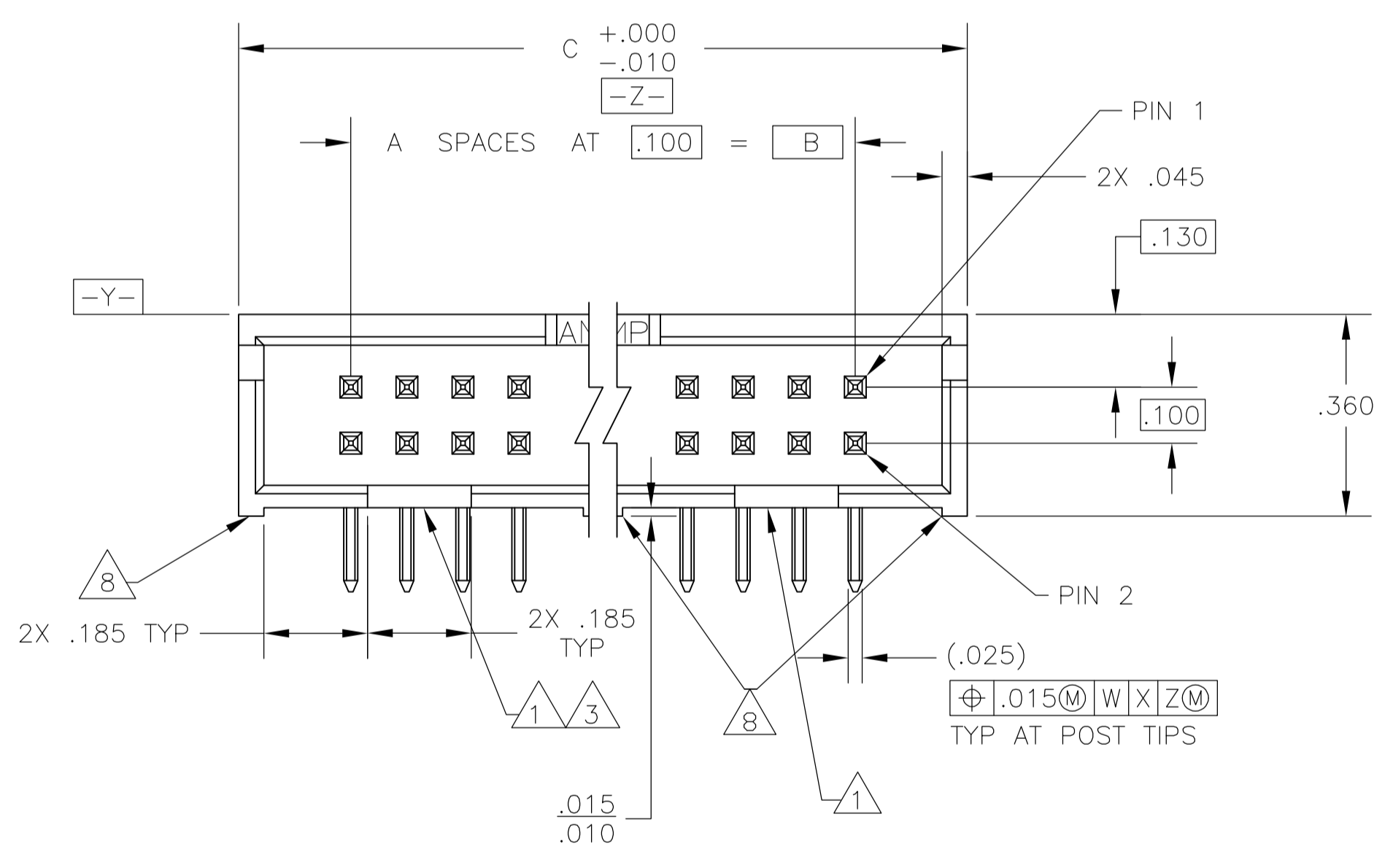
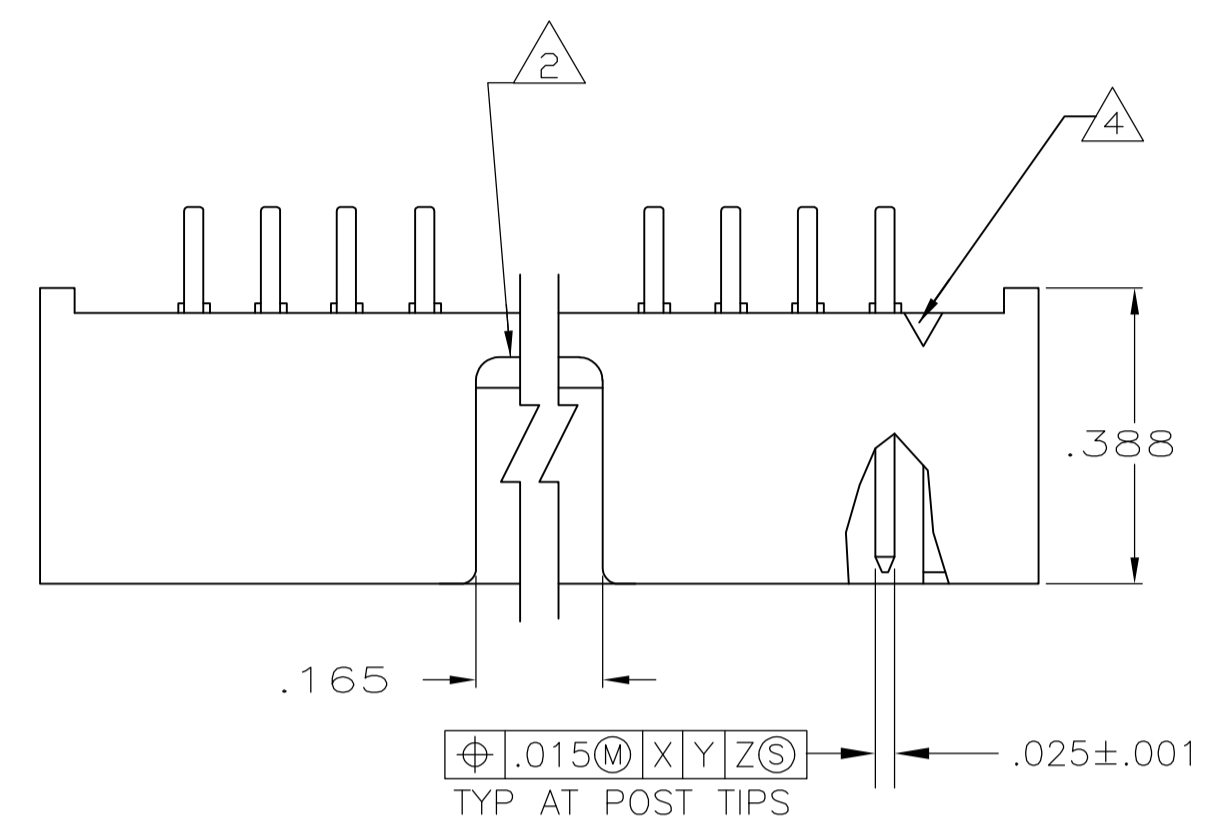

2.800	2.400	24	50	1-5103310-0
2.300	1.900	19	40	5103310-8
2.000	1.600	16	34	5103310-7
1.600	1.200	12	26	5103310-6
1.300	.900	9	20	5103310-5
1.100	.700	7	16	5103310-3
1.000	.600	6	14	5103310-2
.800	.400	4	10	5103310-1
C	B	A	NO OF POSN	PART NUMBER

THIS DRAWING IS A CONTROLLED DOCUMENT

DIN	B. LATTUCA	02 NOV 05
CHK	S. BOLASH	02 NOV 05
APPD	M. WALMSLEY	02 NOV 05

TE Connectivity

NAME: HEADER ASSY, RIGHT ANGLE, LOW PROFILE, AMP-LATCH

PRODUCT SPEC: 108-40018

APPLICATION SPEC: -

SIZE: A1

WEIGHT: -

CAGE CODE: 00779

DRAWING NO: 5103310

RESTRICTED TO: -

CUSTOMER DRAWING

SCALE: 4:1

SHEET: 1 OF 1

REV: E

Mouser Electronics

Authorized Distributor

Click to View Pricing, Inventory, Delivery & Lifecycle Information:

[TE Connectivity:](#)

[5103310-6](#)