

CUSTOMER DRAWING

REV:
E

DATE:
Sep 24, 2012

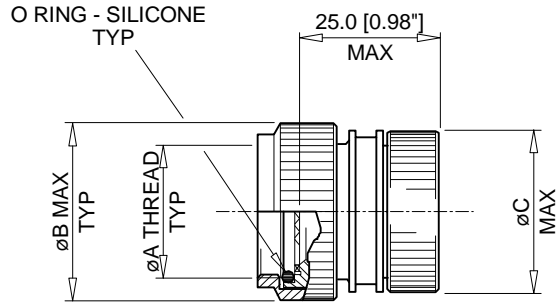

STRAIGHT ADAPTOR

-00

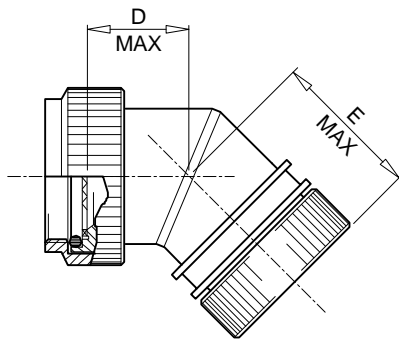
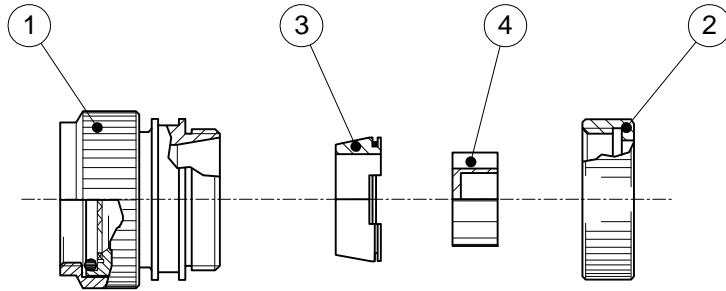

45° ADAPTOR

-45

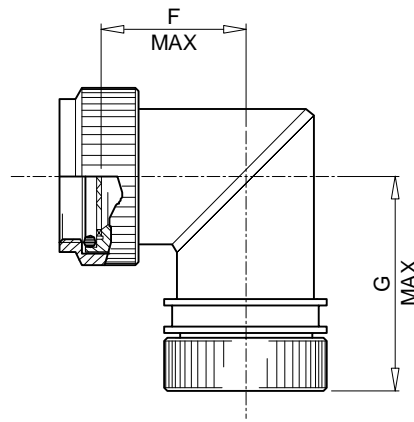

90° ADAPTOR

-90

© 2012 Tyco Electronics Corporation, a TE Connectivity Ltd. Company. All Rights reserved.

		TE Connectivity 300 Constitution Drive Menlo Park, CA 94025, USA		TITLE: HEXASHIELD ADAPTOR FOR CODE 40 CONNECTORS, PLAIN CLAMPING NUT	
UNLESS OTHERWISE SPECIFIED DIMENSIONS ARE IN MILLIMETERS. INCH DIMENSIONS ARE SHOWN IN BRACKETS		TE Connectivity reserves the right to amend this drawing at any time. Users should evaluate the suitability of the product for their application.		DOCUMENT NO. HEX40-AY-YY-YY-AYY-1-Y	
DRAWN: CRJ	DATE: MAR 00	CAGE CODE: 06090	REVISED PER ECO-12-017034	FILE: hex40_ay_yy_yy_ayy_1_y.doc	SCALE: NONE SHEET: 1 OF 3

If this document is printed it becomes uncontrolled. Check for the latest revision

CUSTOMER DRAWING

 REV:
E

 DATE:
Sep 24, 2012

KIT DESCRIPTION

ITEM	DESCRIPTION	MATERIAL
1	BODY ASSEMBLY	ALUMINIUM ALLOY
2	CLAMPING NUT - PLAIN	ALUMINIUM ALLOY
3	CONIC RING	ALUMINIUM ALLOY
4	STAR	ALUMINIUM ALLOY

TABLE OF DIMENSIONS

Order Number	Shell Size		ØA Thread Class 6H	ØB Max	ØC Max	D Max	E Max	F Max	G Max	Ferrule Quantity	
	Mil.	Com.								Std.	Opt.
09	A	09	M12 x 1	0.75" [19.0]	0.69" [17.5]	0.57" [14.5]	1.00" [25.5]	0.71" [18.0]	1.14" [29.0]	1	-
11	B	11	M15 x 1	0.87" [22.0]	0.85" [21.5]	0.59" [15.0]	1.02" [26.0]	0.77" [19.6]	1.20" [30.5]	2	-
13	C	13	M18 x 1	1.00" [25.5]	0.89" [22.5]	0.63" [16.0]	1.04" [26.5]	0.83" [21.1]	1.26" [32.0]	3	-
15	D	15	M22 x 1	1.20" [30.5]	1.00" [25.5]	0.65" [16.5]	1.08" [27.5]	0.89" [22.6]	1.32" [33.5]	5	-
17	E	17	M25 x 1	1.32" [33.5]	1.12" [28.5]	0.67" [17.0]	1.10" [28.0]	0.95" [24.1]	1.38" [35.0]	6	7
19	F	19	M28 x 1	1.46" [37.0]	1.24" [31.5]	0.69" [17.5]	1.12" [28.5]	1.01" [25.7]	1.44" [36.5]	7	-
21	G	21	M31 x 1	1.52" [38.5]	1.38" [35.0]	0.73" [18.5]	1.14" [29.0]	1.08" [27.4]	1.52" [38.5]	9	11
23	H	23	M34 x 1	1.65" [42.0]	1.50" [38.0]	0.75" [19.1]	1.18" [30.0]	1.14" [29.0]	1.57" [40.0]	10	13
25	J	25	M37 x 1	1.83" [46.5]	1.61" [41.0]	0.75" [19.1]	1.22" [31.0]	1.20" [30.5]	1.63" [41.5]	12	17

PART NUMBERING

HEX40-AB-00-21-A9-1-DS-U

-CONNECTOR CODE NUMBER: _____
 HEX40 = MIL-C-38999 SERIES III AND IV
 -MATERIAL CODE: _____
 A = ALUMINIUM ALLOY
 -PLATING CODE: _____
 B = CADMIUM OLIVE DRAB TO QQ-P416
 C = ELECTROLESS NICKEL TO MIL-C-26074
 -BODY STYLE: _____
 00 = STRAIGHT
 45 = 45°
 90 = 90°
 -ORDER NUMBER _____
 -FERRULE QUANTITY CODE _____
 -1 = PLAIN CLAMPING NUT
 -DS = DRILLED STAR - OPTIONAL - SEE NOTE 2
 -U = FLUOROSILICONE O-RING - OPTIONAL

© 2012 Tyco Electronics Corporation, a TE Connectivity Ltd. Company. All Rights reserved.

		TE Connectivity 300 Constitution Drive Menlo Park, CA 94025, USA		TITLE: HEXASHIELD ADAPTOR FOR CODE 40 CONNECTORS, PLAIN CLAMPING NUT	
UNLESS OTHERWISE SPECIFIED DIMENSIONS ARE IN MILLIMETERS. INCH DIMENSIONS ARE SHOWN IN BRACKETS		TE Connectivity reserves the right to amend this drawing at any time. Users should evaluate the suitability of the product for their application.		DOCUMENT NO. HEX40-AY-YY-YY-AYY-1-Y	
DRAWN: CRJ	DATE: MAR 00	CAGE CODE: 06090	REVISED PER ECO-12-017034	FILE: hex40_ay_yy_yy_ayy_1_y.doc	SCALE: SHEET: NONE 2 OF 3

If this document is printed it becomes uncontrolled. Check for the latest revision

CUSTOMER DRAWING

REV:
E

DATE:
Sep 24, 2012

APPLICATION

- These adaptors are designed to be mounted on the following connectors:

MIL-C-38999 Series III and IV

- They are qualified to the Raychem specification RB-114, when installed on metallic Mil-Specification circular connectors only.
- They are designed primarily for open wire bundle installation but are also designed to accept Raychem heat shrink moulded parts where strain relief is required – see illustration.

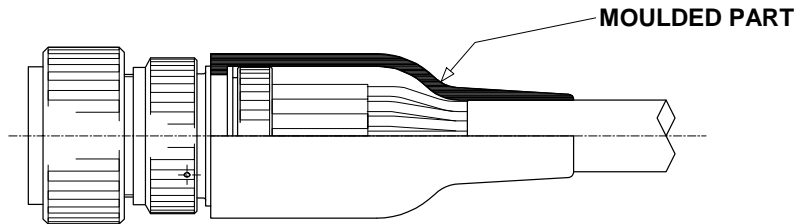

- Use in conjunction with the ferrules HET-A-0XX, which are purchased separately. Refer to HET-A-0XX S.C.D. for relevant selection details.

INSTALLATION

- See Installation Procedure RPIP-696-04.

PACKAGING

- All components are supplied in a plastic bag.

NOTES!

1. Item 4 - Star - is **not** supplied with Hexashield Order Number 09.
2. The DS option, illustrated below, is for a Drilled Star that is available on sizes 15 to 25 only. This option is to allow unshielded wires to pass through the assembly.

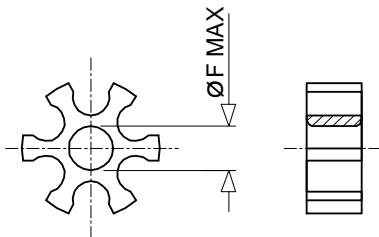

STAR SIZE	15	17	19	21	23	25
ØD MAX	0.12" [3.0]	0.24" [6.0]	0.35" [9.0]	0.47" [12.0]	0.59" [15.0]	0.71" [18.0]

3. Where the ferrule quantities required are standard, the item 4 - Star - is also standard.
If the optional quantity is selected then 2 items 4 will be supplied - one "split" and the other one standard.
See below for illustration.

EXAMPLE: FERRULE QUANTITY CODE -A13

-A13 = -A10 SPLIT STAR + -A3 STANDARD STAR

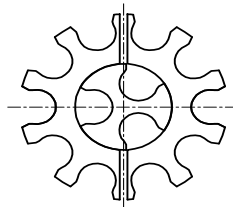

4. Assembly is to be permanently marked with Code Identity Number and Part Number.
(e.g. 06090 HEX40-AB-00-21-A9-1)

© 2012 Tyco Electronics Corporation, a TE Connectivity Ltd. Company. All Rights reserved.

		TE Connectivity 300 Constitution Drive Menlo Park, CA 94025, USA		TITLE: HEXASHIELD ADAPTOR FOR CODE 40 CONNECTORS, PLAIN CLAMPING NUT	
UNLESS OTHERWISE SPECIFIED DIMENSIONS ARE IN MILLIMETERS. INCH DIMENSIONS ARE SHOWN IN BRACKETS		TE Connectivity reserves the right to amend this drawing at any time. Users should evaluate the suitability of the product for their application.		DOCUMENT NO. HEX40-AY-YY-YY-AYY-1-Y	
DRAWN: CRJ	DATE: MAR 00	CAGE CODE: 06090	REVISED PER ECO-12-017034	FILE: hex40_ay_yy_yy_ayy_1_y.doc	SCALE: SHEET: NONE 3 OF 3

If this document is printed it becomes uncontrolled. Check for the latest revision

Mouser Electronics

Authorized Distributor

Click to View Pricing, Inventory, Delivery & Lifecycle Information:

[TE Connectivity:](#)

[HEX40-AC-90-09-A1-1](#)