

## 420-MHz HIGH-SPEED CURRENT-FEEDBACK AMPLIFIER

Check for Samples: [THS3001](#)

### FEATURES

- **High Speed:**
  - 420-MHz Bandwidth ( $G = 1$ , -3 dB)
  - 6500-V/ $\mu$ s Slew Rate
  - 40-ns Settling Time (0.1%)
- **High Output Drive:**  $I_O = 100$  mA
- **Excellent Video Performance**
  - 115-MHz Bandwidth (0.1 dB,  $G = 2$ )
  - 0.01% Differential Gain
  - 0.02° Differential Phase
- **Low 3-mV (max) Input Offset Voltage**
- **Very Low Distortion:**
  - THD = -96 dBc at  $f = 1$  MHz
  - THD = -80 dBc at  $f = 10$  MHz
- **Wide Range of Power Supplies:**
  - $V_{CC} = \pm 4.5$  V to  $\pm 16$  V
- **Evaluation Module Available**

### APPLICATIONS

- **Communication**
- **Imaging**
- **High-Quality Video**

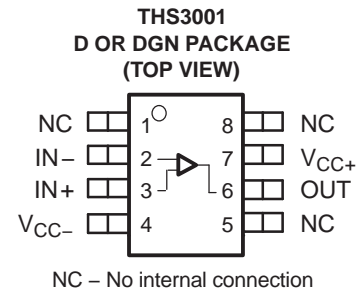

### RELATED DEVICES

<a href="#">THS4011 /2</a>	290-MHz VFB High-Speed Amplifier
<a href="#">THS6012</a>	500-mA CFB High-Speed Amplifier
<a href="#">THS6022</a>	250-mA CFB High-Speed Amplifier

### DESCRIPTION

The THS3001 is a high-speed current-feedback operational amplifier, ideal for communication, imaging, and high-quality video applications. This device offers a very fast 6500-V/ $\mu$ s slew rate, a 420-MHz bandwidth, and 40-ns settling time for large-signal applications requiring excellent transient response. In addition, the THS3001 operates with a very low distortion of -96 dBc, making it well suited for applications such as wireless communication basestations or ultrafast ADC or DAC buffers.

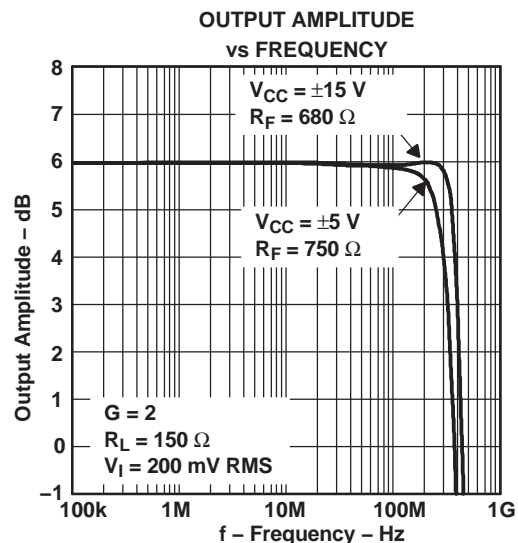
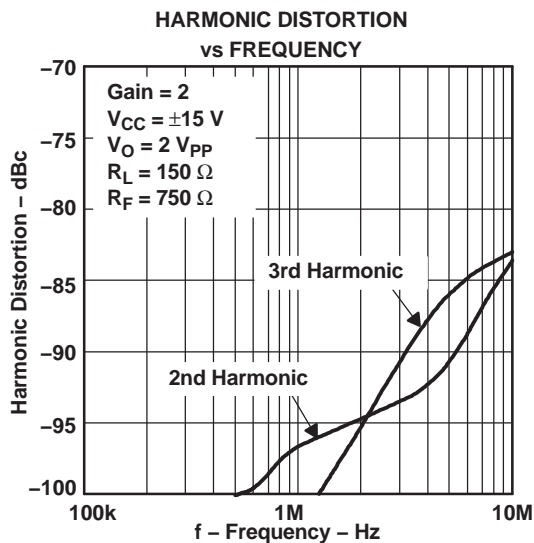

Please be aware that an important notice concerning availability, standard warranty, and use in critical applications of Texas Instruments semiconductor products and disclaimers thereto appears at the end of this data sheet.

All trademarks are the property of their respective owners.



This integrated circuit can be damaged by ESD. Texas Instruments recommends that all integrated circuits be handled with appropriate precautions. Failure to observe proper handling and installation procedures can cause damage.

ESD damage can range from subtle performance degradation to complete device failure. Precision integrated circuits may be more susceptible to damage because very small parametric changes could cause the device not to meet its published specifications.

**AVAILABLE OPTIONS<sup>(1)</sup>**

T <sub>A</sub>	PACKAGED DEVICE			TRANSPORT MEDIA, QUANTITY	EVALUATION MODULE
	SOIC (D)	MSOP (DGN)	MSOP SYMBOL		
0°C to 70°C	THS3001CD	THS3001CDGN	ADP	Rails, 75	THS3001EVM
	THS3001CDR	THS3001CDGNR		Tape and Reel, 2500	--
		THS3001HVCDGN	BNK	Rails, 75	--
		THS3001HVCDGNR		Tape and Reel, 2500	--
-40°C to 85°C	THS3001ID	THS3001IDGN	ADQ	Rails, 75	--
	THS3001IDR	THS3001IDGNR		Tape and Reel, 2500	--
		THS3001HVIDGN	BNJ	Rails, 75	--
		THS3001HVIDGNR		Tape and Reel, 2500	--

(1) For the most current package and ordering information, see the Package Option Addendum at the end of this document, or see the TI website at [www.ti.com](http://www.ti.com).

**ABSOLUTE MAXIMUM RATINGS<sup>(1)</sup>**

over operating free-air temperature range (unless otherwise noted)

		THS3001	THS3001HV	UNITS
V <sub>SS</sub>	Supply voltage, V <sub>CC+</sub> to V <sub>CC-</sub>	33	37	V
V <sub>I</sub>	Input voltage	±V <sub>CC</sub>	±V <sub>CC</sub>	V
I <sub>O</sub>	Output current	175	175	mA
V <sub>ID</sub>	Differential input voltage	±6	±6	V
	Continuous total power dissipation	See <a href="#">Dissipation Rating Table</a>		
T <sub>J</sub>	Maximum junction temperature <sup>(2)</sup>	150	150	°C
T <sub>J</sub>	Maximum junction temperature, continuous operation, long term reliability <sup>(3)</sup>	125	125	°C
T <sub>A</sub>	Operating free-air temperature	THS3001C, THS3001HVC	0 to 70	°C
		THS3001I, THS3001HVI	-40 to 85	°C
T <sub>stg</sub>	Storage temperature	-65 to 125	-65 to 125	°C

- (1) Stresses above these ratings may cause permanent damage. Exposure to absolute maximum conditions for extended periods may degrade device reliability. These are stress ratings only, and functional operation of the device at these or any other conditions beyond those specified is not implied.
- (2) The absolute maximum temperature under any condition is limited by the constraints of the silicon process.
- (3) The maximum junction temperature for continuous operation is limited by package constraints. Operation above this temperature may result in reduced reliability and/or lifetime of the device.

**DISSIPATION RATING TABLE**

PACKAGE	θ <sub>JC</sub> (°C/W)	θ <sub>JA</sub> <sup>(1)</sup> (°C/W)	POWER RATING <sup>(2)</sup>	
			T <sub>A</sub> ≤ 25°C	T <sub>A</sub> = 85°C
D (8)	38.3	97.5	1.02 W	410 mW
DGN (8)	4.7	58.4	1.71 W	685 mW

- (1) This data was taken using the JEDEC standard High-K test PCB.
- (2) Power rating is determined with a junction temperature of 125°C. This is the point where distortion starts to substantially increase. Thermal management of the final PCB should strive to keep the junction temperature at or below 125°C for best performance and long term reliability.

**RECOMMENDED OPERATING CONDITIONS**

				MIN	NOM	MAX	UNIT
V <sub>SS</sub>	Supply voltage, V <sub>CC+</sub> and V <sub>CC-</sub>	Split supply	THS3001C, THS3001I	±4.5		±16	V
		Single supply		9		32	
		Split supply	THS3001HVC, THS3001HVI	±4.5		±18.5	
		Single supply		9		37	
T <sub>A</sub>	Operating free-air temperature	THS3001C, THS3001HVC		0		70	°C
		THS3001I, THS3001HVI		-40		85	

**ELECTRICAL CHARACTERISTICS**

 At T<sub>A</sub> = 25°C, R<sub>L</sub> = 150 Ω, R<sub>F</sub> = 1 kΩ (unless otherwise noted)

PARAMETER		TEST CONDITIONS (1)		MIN	TYP	MAX	UNIT		
V <sub>CC</sub>	Power supply operating range	Split supply	THS3001C THS3001I	±4.5		±16.5	V		
			THS3001HVx	±4.5		±18.5			
		Single supply	THS3001C THS3001I	9		33			
			THS3001HVx	9		37			
I <sub>CC</sub>	Quiescent current	V <sub>CC</sub> = ±5 V	T <sub>A</sub> = 25°C		5.5	7.5	mA		
			T <sub>A</sub> = full range			8.5			
		V <sub>CC</sub> = ±15 V	T <sub>A</sub> = 25°C		6.6	9			
			T <sub>A</sub> = full range			10			
		V <sub>CC</sub> = ±18.5 V, THS3001HV	T <sub>A</sub> = 25°C		6.9	9.5			
			T <sub>A</sub> = full range			10.5			
V <sub>O</sub>	Output voltage swing	V <sub>CC</sub> = ±5 V	R <sub>L</sub> = 150 Ω	±2.9	±3.2	V			
			R <sub>L</sub> = 1 kΩ	±3	±3.3				
		V <sub>CC</sub> = ±15 V	R <sub>L</sub> = 150 Ω	±12.1	±12.8				
			R <sub>L</sub> = 1 kΩ	±12.8	±13.1				
I <sub>O</sub>	Output current(2)	V <sub>CC</sub> = ±5 V, R <sub>L</sub> = 20 Ω		100	mA				
		V <sub>CC</sub> = ±15 V, R <sub>L</sub> = 75 Ω	85	120					
V <sub>IO</sub>	Input offset voltage	V <sub>CC</sub> = ±5 V or ±15 V	T <sub>A</sub> = 25°C		1	3	mV		
			T <sub>A</sub> = full range					4	
Input offset voltage drift		V <sub>CC</sub> = ±5 V or ±15 V			5		μV/°C		
I <sub>IB</sub>	Input bias current	Positive (IN+)	V <sub>CC</sub> = ±5 V or ±15 V	T <sub>A</sub> = 25°C		2	10	μA	
				T <sub>A</sub> = full range					15
		Negative (IN-)		T <sub>A</sub> = 25°C			1		10
				T <sub>A</sub> = full range					
V <sub>ICR</sub>	Common-mode input voltage range	V <sub>CC</sub> = ±5 V		±3	±3.2	V			
		V <sub>CC</sub> = ±15 V		±12.9	±13.2				
Open loop transresistance		V <sub>CC</sub> = ±5 V, V <sub>O</sub> = ±2.5 V, R <sub>L</sub> = 1 kΩ			1.3	MΩ			
		V <sub>CC</sub> = ±15 V, V <sub>O</sub> = ±7.5 V, R <sub>L</sub> = 1 kΩ			2.4				
CMRR	Common-mode rejection ratio	V <sub>CC</sub> = ±5 V, V <sub>CM</sub> = ±2.5 V		62	70	dB			
		V <sub>CC</sub> = ±15 V, V <sub>CM</sub> = ±10 V		65	73				
PSRR	Power supply rejection ratio	V <sub>CC</sub> = ±5 V	T <sub>A</sub> = 25°C		65	76	dB		
			T <sub>A</sub> = full range			63			
		V <sub>CC</sub> = ±15 V	T <sub>A</sub> = 25°C		69	76	dB		
			T <sub>A</sub> = full range			67			

(1) Full range = 0°C to 70°C for the THS3001C and -40°C to 85°C for the THS3001I.

 (2) Observe power dissipation ratings to keep the junction temperature below absolute maximum when the output is heavily loaded or shorted. See [Absolute Maximum Ratings](#) table.

## ELECTRICAL CHARACTERISTICS (continued)

At  $T_A = 25^\circ\text{C}$ ,  $R_L = 150\ \Omega$ ,  $R_F = 1\ \text{k}\Omega$  (unless otherwise noted)

PARAMETER		TEST CONDITIONS <sup>(1)</sup>	MIN	TYP	MAX	UNIT
R <sub>I</sub>	Input resistance	Positive (IN+)		1.5		M $\Omega$
		Negative (IN-)		15		$\Omega$
C <sub>I</sub>	Differential input capacitance			7.5		pF
R <sub>O</sub>	Output resistance	Open loop at 5 MHz		10		$\Omega$
V <sub>n</sub>	Input voltage noise	$V_{CC} = \pm 5\ \text{V}$ or $\pm 15\ \text{V}$ , $f = 10\ \text{kHz}$ , $G = 2$		1.6		nV/ $\sqrt{\text{Hz}}$
I <sub>n</sub>	Input current noise	Positive (IN+)		13		pA/ $\sqrt{\text{Hz}}$
		Negative (IN-)	$V_{CC} = \pm 5\ \text{V}$ or $\pm 15\ \text{V}$ , $f = 10\ \text{kHz}$ , $G = 2$	16		

## OPERATING CHARACTERISTICS

$T_A = 25^\circ\text{C}$ ,  $R_L = 150\ \Omega$ ,  $R_F = 1\ \text{k}\Omega$  (unless otherwise noted)

PARAMETER		TEST CONDITIONS	MIN	TYP	MAX	UNIT
SR	Slew rate <sup>(1)</sup>	$V_{CC} = \pm 5\ \text{V}$ , $V_{O(PP)} = 4\ \text{V}$	$G = -5$		1700	V/ $\mu\text{s}$
			$G = 5$		1300	
		$V_{CC} = \pm 15\ \text{V}$ , $V_{O(PP)} = 20\ \text{V}$	$G = -5$		6500	
			$G = 5$		6300	
t <sub>s</sub>	Settling time to 0.1%	$V_{CC} = \pm 15\ \text{V}$ , 0 V to 10 V Step	Gain = -1,		40	ns
	Settling time to 0.1%	$V_{CC} = \pm 5\ \text{V}$ , 0 V to 2 V Step,	Gain = -1,		25	
THD	Total harmonic distortion	$V_{CC} = \pm 15\ \text{V}$ , $f_c = 10\ \text{MHz}$ ,	$V_{O(PP)} = 2\ \text{V}$ , $G = 2$		-80	dBc
	Differential gain error	$G = 2$ , 40 IRE modulation, $\pm 100$ IRE Ramp, NTSC and PAL	$V_{CC} = \pm 5\ \text{V}$		0.015%	
	Differential phase error	$G = 2$ , 40 IRE modulation, $\pm 100$ IRE Ramp, NTSC and PAL	$V_{CC} = \pm 5\ \text{V}$		0.01°	
			$V_{CC} = \pm 15\ \text{V}$		0.02°	
BW	Small signal bandwidth (-3 dB)	$G = 1$ , $R_F = 1\ \text{k}\Omega$	$V_{CC} = \pm 5\ \text{V}$		330	MHz
			$V_{CC} = \pm 15\ \text{V}$		420	MHz
		$G = 2$ , $R_F = 750\ \Omega$ ,	$V_{CC} = \pm 5\ \text{V}$		300	MHz
			$V_{CC} = \pm 15\ \text{V}$		385	
	Bandwidth for 0.1 dB flatness	$G = 2$ , $R_F = 680\ \Omega$ ,	$V_{CC} = \pm 5\ \text{V}$		350	MHz
			$V_{CC} = \pm 15\ \text{V}$		85	
Full power bandwidth <sup>(2)</sup>	$V_{CC} = \pm 5\ \text{V}$ , $V_{O(PP)} = 4\ \text{V}$ , $R_L = 500\ \Omega$	$G = -5$		65	MHz	
		$G = 5$		62		
	$V_{CC} = \pm 15\ \text{V}$ , $V_{O(PP)} = 20\ \text{V}$ , $R_L = 500\ \Omega$	$G = -5$		32		
		$G = 5$		31		

(1) Slew rate is measured from an output level range of 25% to 75%.

(2) Full power bandwidth is defined as the frequency at which the output has 3% THD.

**PARAMETER MEASUREMENT INFORMATION**

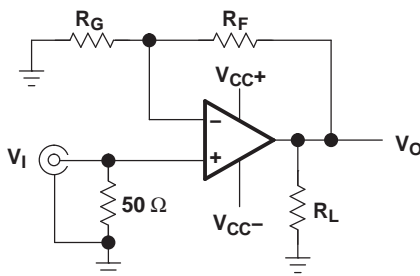

**Figure 1. Test Circuit, Gain = 1 + (R<sub>F</sub>/R<sub>G</sub>)**

**TYPICAL CHARACTERISTICS**

**Table of Graphs**

			<b>FIGURE</b>
V <sub>O</sub>	Output voltage swing	vs Free-air temperature	2
I <sub>CC</sub>	Current supply	vs Free-air temperature	3
I <sub>IB</sub>	Input bias current	vs Free-air temperature	4
V <sub>IO</sub>	Input offset voltage	vs Free-air temperature	5
CMRR	Common-mode rejection ratio	vs Common-mode input voltage	6
		vs Common-mode input voltage	7
		vs Frequency	8
	Transresistance	vs Free-air temperature	9
	Closed-loop output impedance	vs Frequency	10
V <sub>n</sub>	Voltage noise	vs Frequency	11
I <sub>n</sub>	Current noise	vs Frequency	11
PSRR	Power supply rejection ratio	vs Frequency	12
		vs Free-air temperature	13
SR	Slew rate	vs Supply voltage	14
		vs Output step peak-to-peak	15, 16
	Normalized slew rate	vs Gain	17
	Harmonic distortion	vs Peak-to-peak output voltage swing	18, 19
		vs Frequency	20, 21
	Differential gain	vs Loading	22, 23
	Differential phase	vs Loading	24, 25
	Output amplitude	vs Frequency	26-30
	Normalized output response	vs Frequency	31-34
	Small and large signal frequency response		35, 36
	Small signal pulse response		37, 38
	Large signal pulse response		39 - 46

TYPICAL CHARACTERISTICS

OUTPUT VOLTAGE SWING  
vs  
FREE-AIR TEMPERATURE

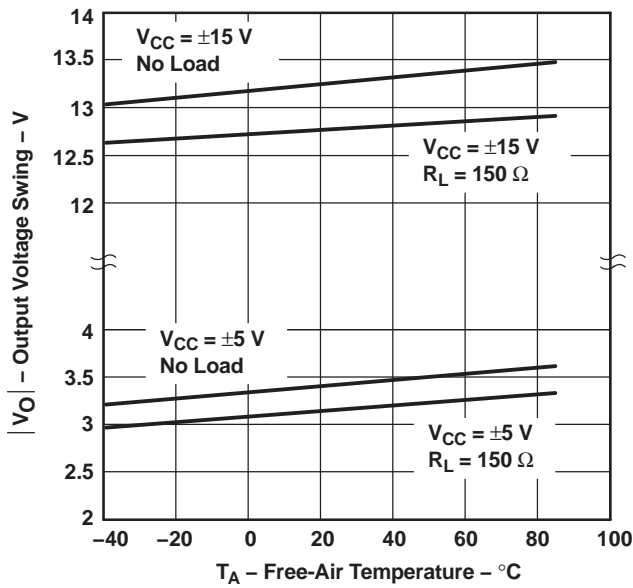

Figure 2.

CURRENT SUPPLY  
vs  
FREE-AIR TEMPERATURE

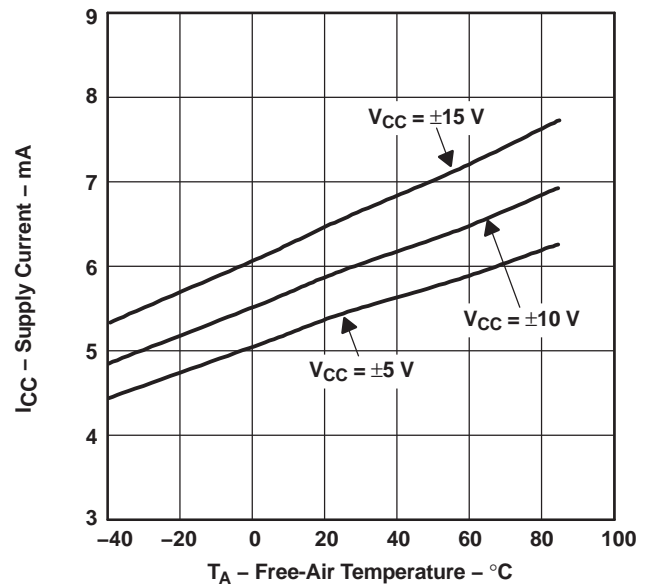

Figure 3.

INPUT BIAS CURRENT  
vs  
FREE-AIR TEMPERATURE

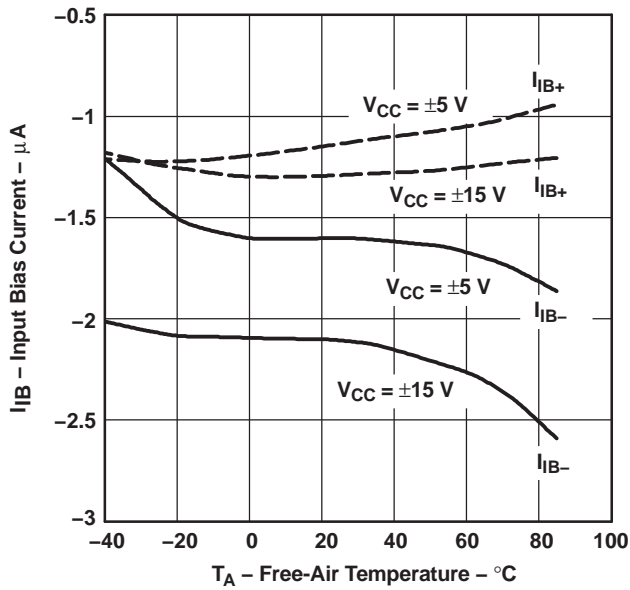

Figure 4.

INPUT OFFSET VOLTAGE  
vs  
FREE-AIR TEMPERATURE

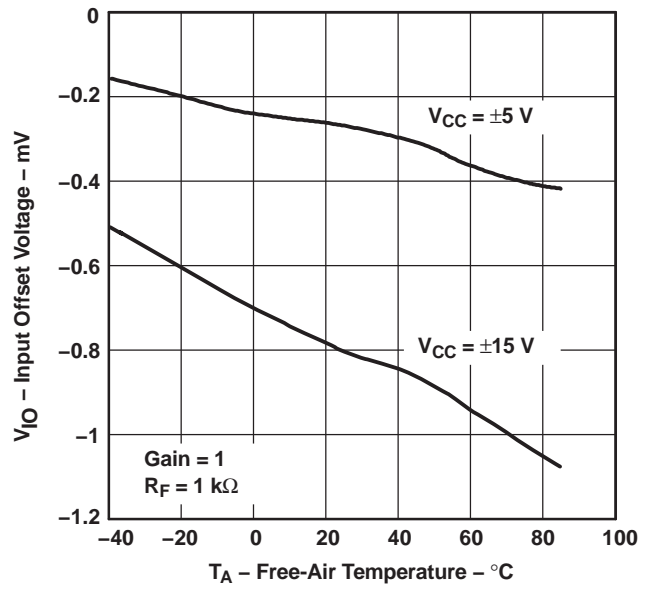

Figure 5.

TYPICAL CHARACTERISTICS (continued)

COMMON-MODE REJECTION RATIO  
vs  
COMMON-MODE INPUT VOLTAGE

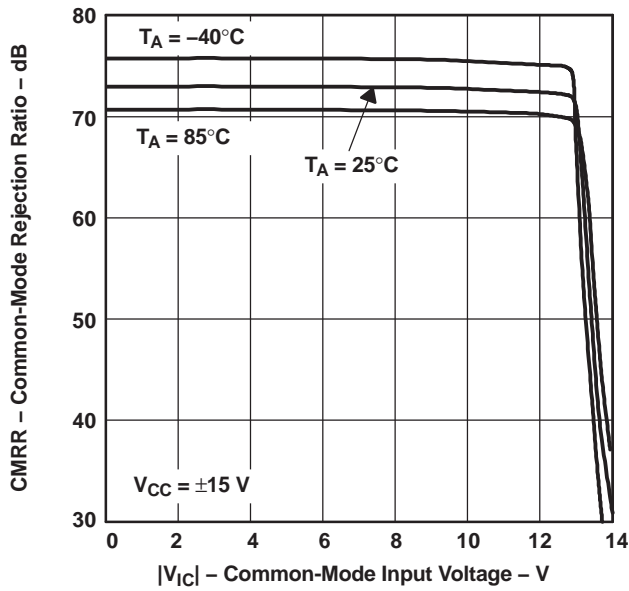

Figure 6.

COMMON-MODE REJECTION RATIO  
vs  
COMMON-MODE INPUT VOLTAGE

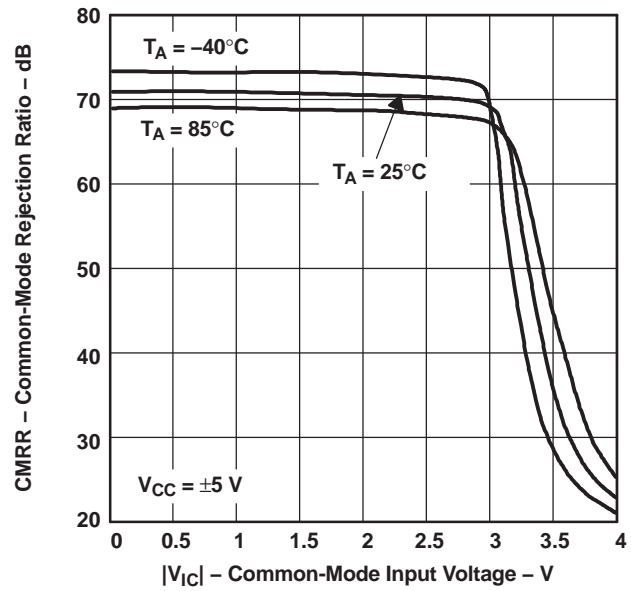

Figure 7.

COMMON-MODE REJECTION RATIO  
vs  
FREQUENCY

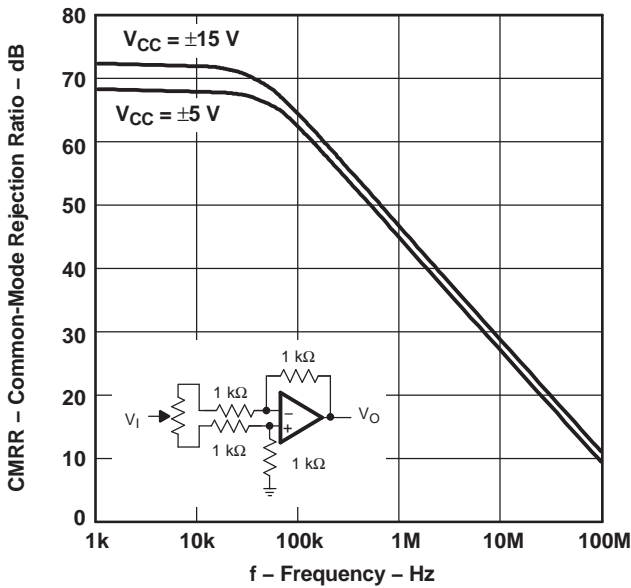

Figure 8.

TRANSRESISTANCE  
vs  
FREE-AIR TEMPERATURE

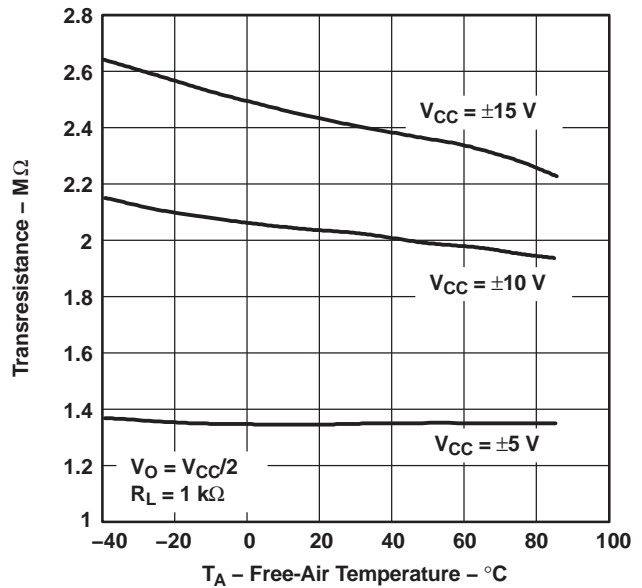
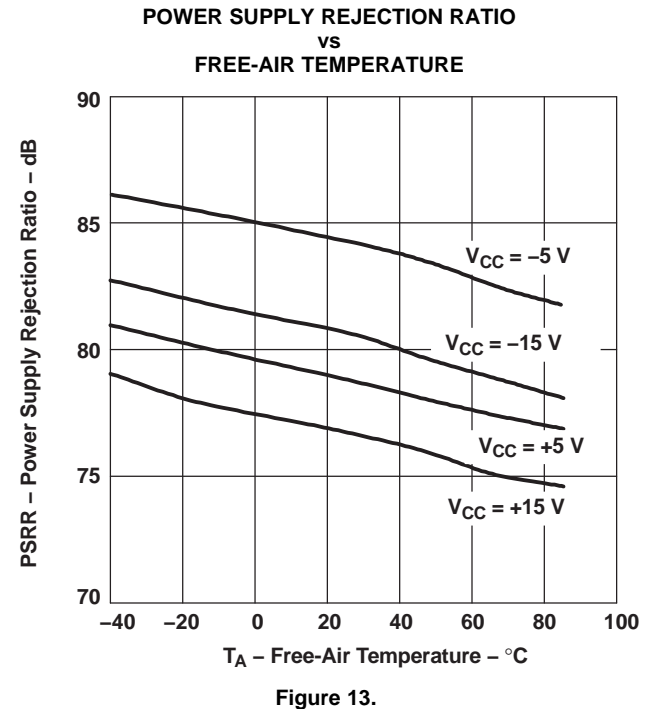
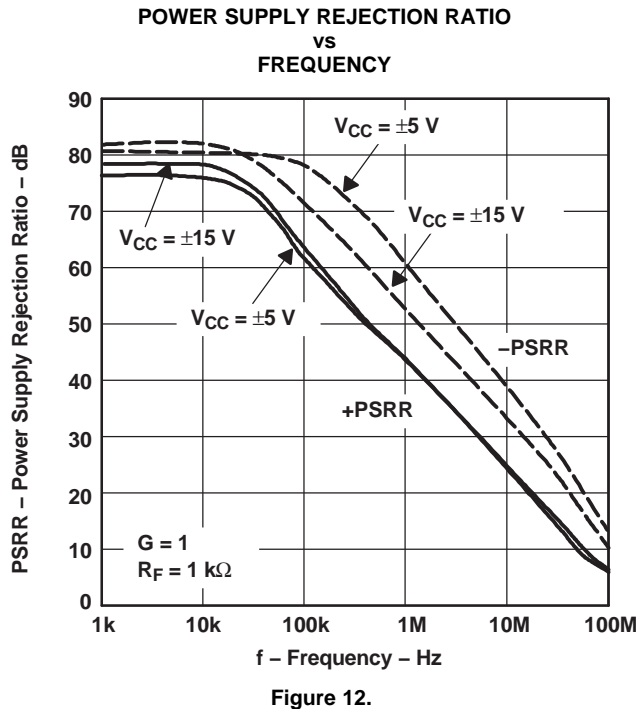
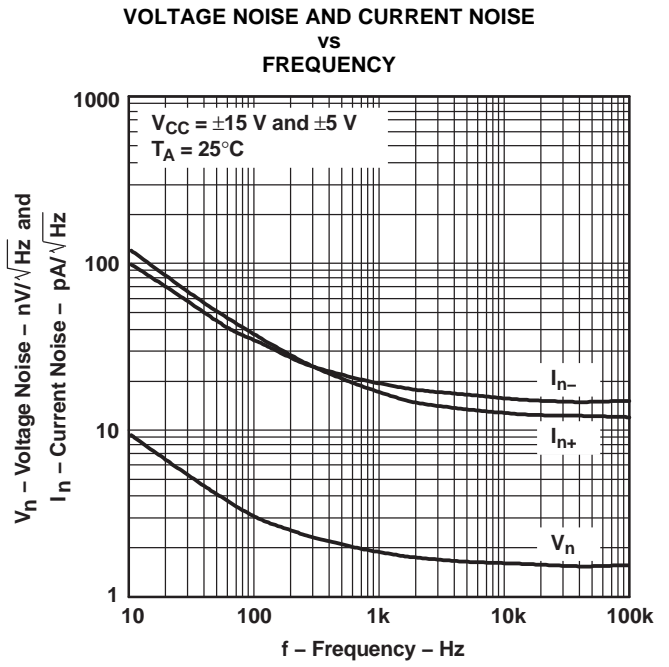
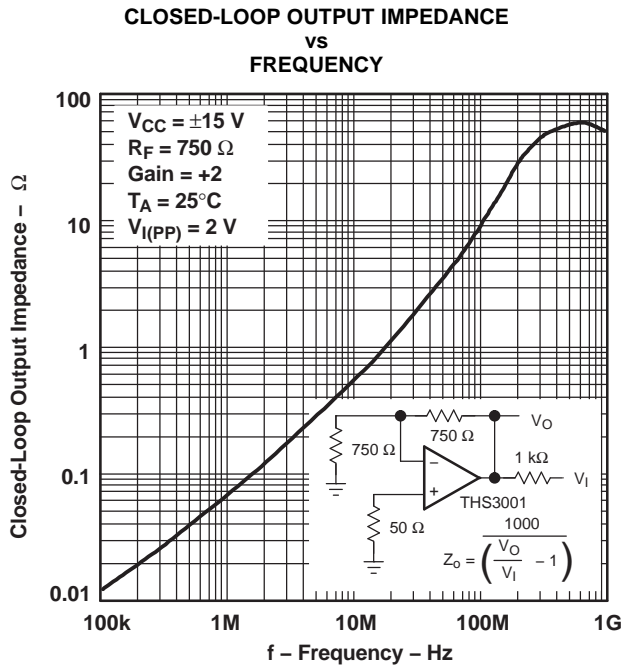

Figure 9.

TYPICAL CHARACTERISTICS (continued)





TYPICAL CHARACTERISTICS (continued)

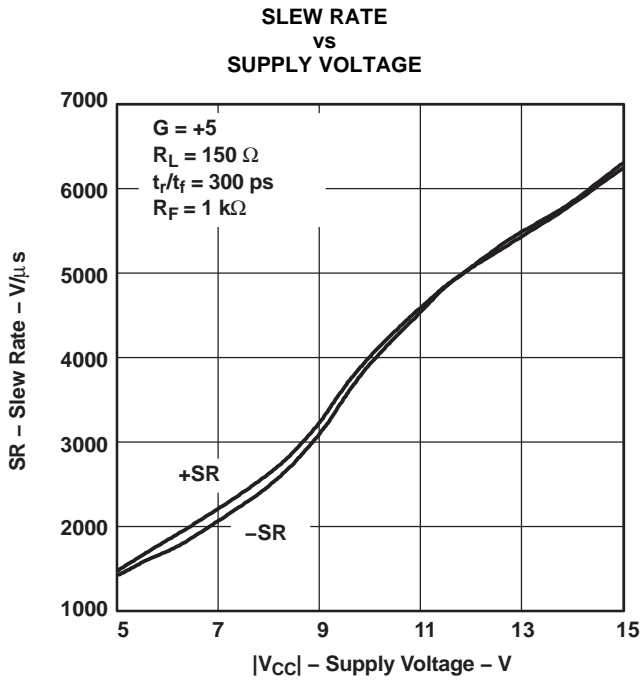

Figure 14.

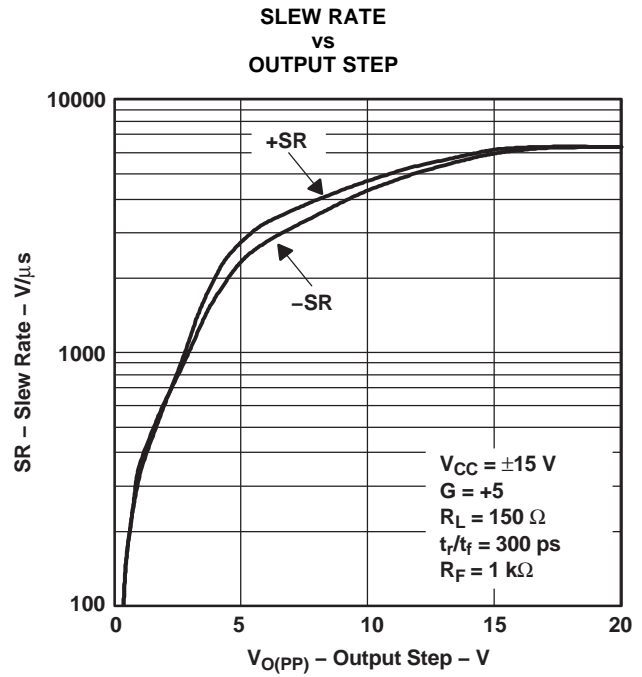

Figure 15.

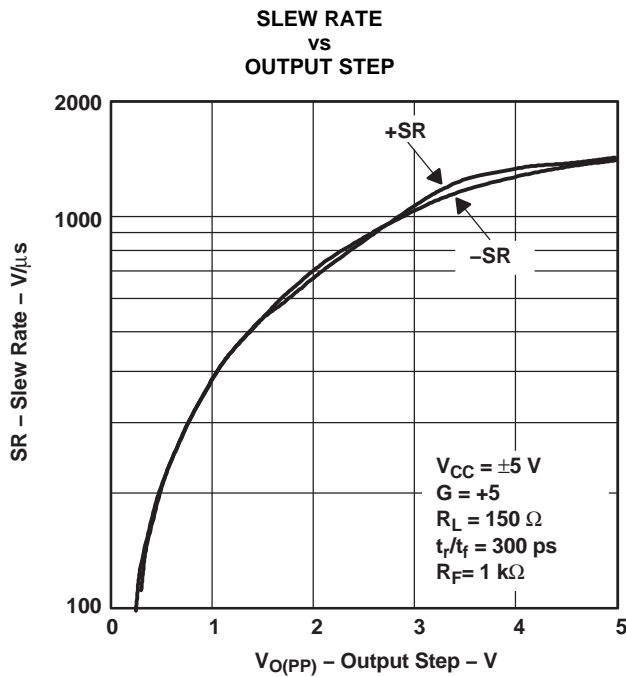

Figure 16.

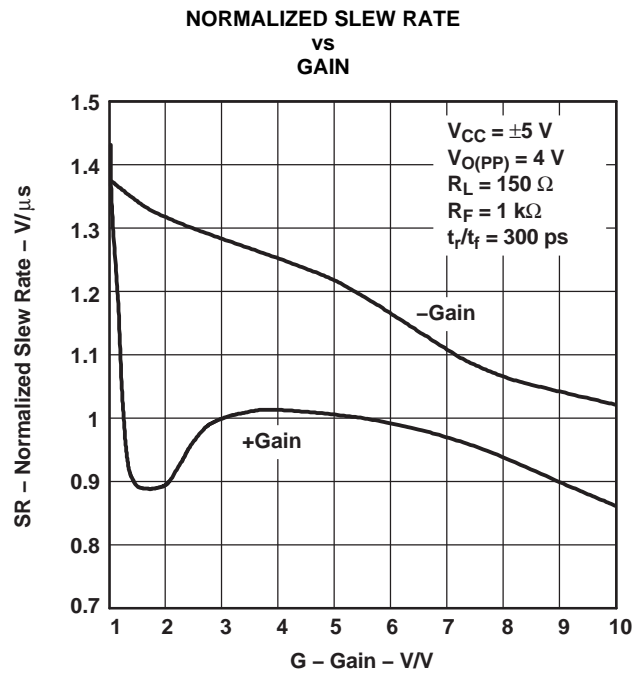

Figure 17.

**TYPICAL CHARACTERISTICS (continued)**

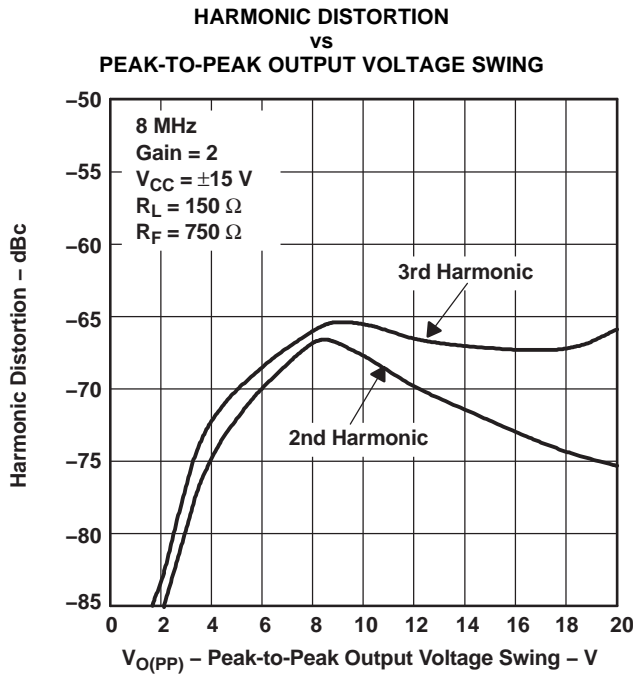

Figure 18.

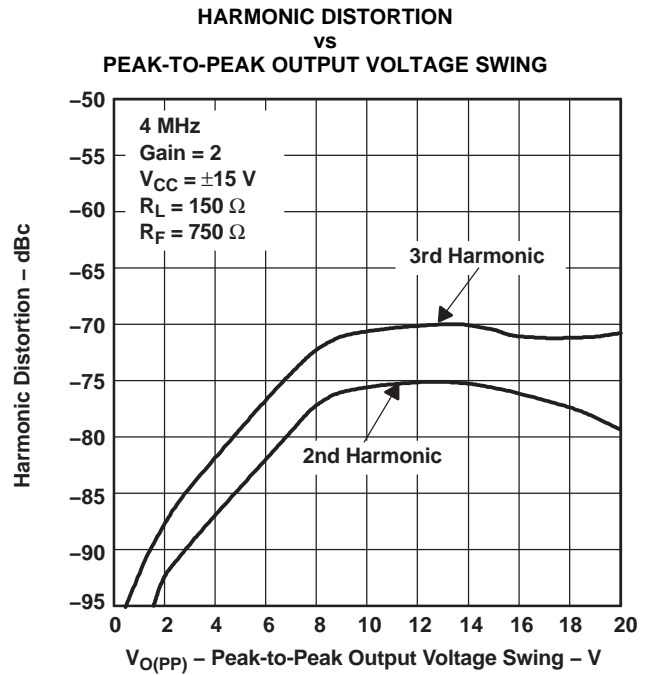

Figure 19.

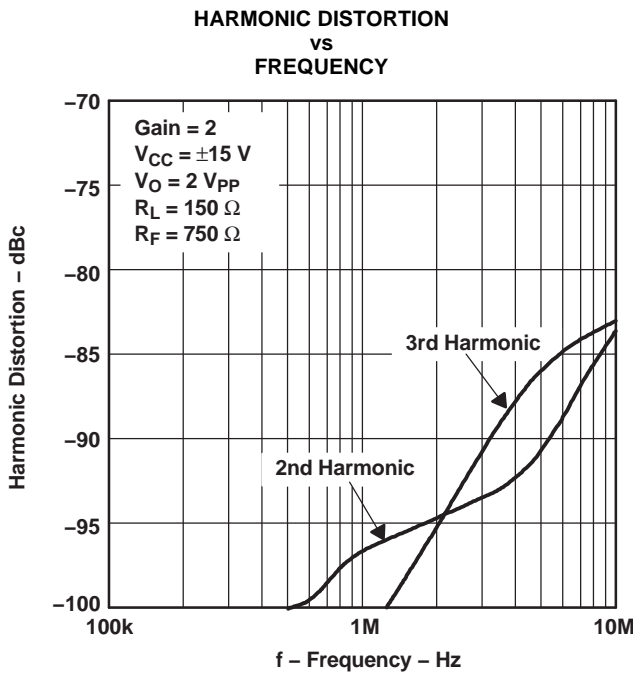

Figure 20.

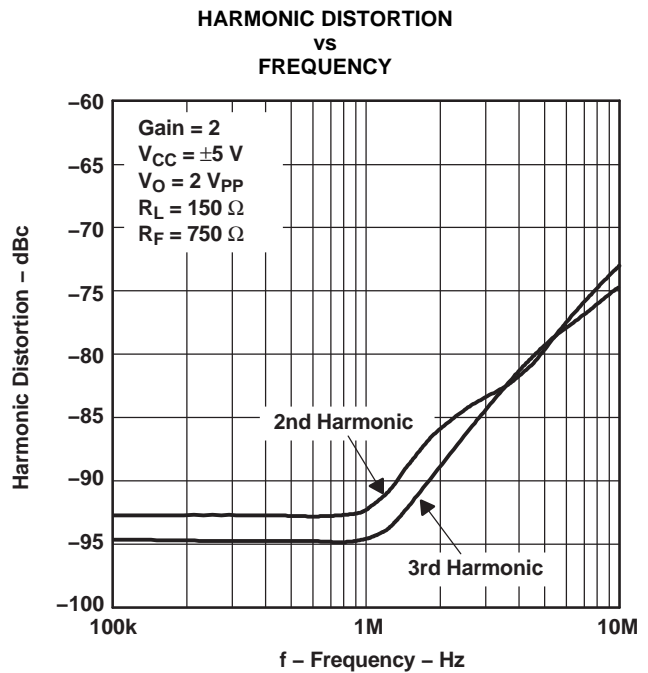

Figure 21.

TYPICAL CHARACTERISTICS (continued)

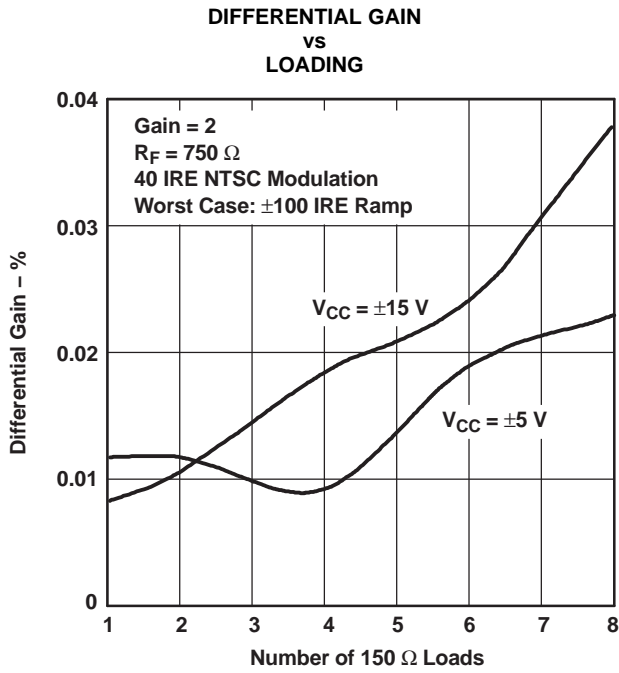

Figure 22.

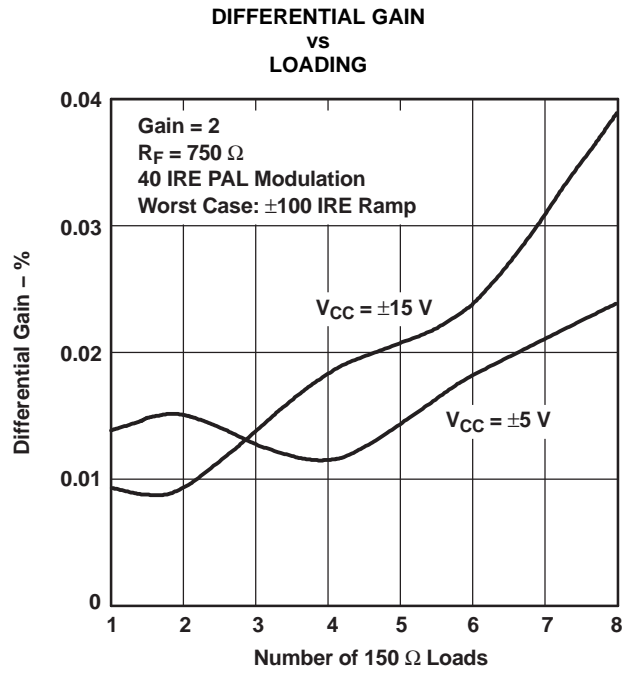

Figure 23.

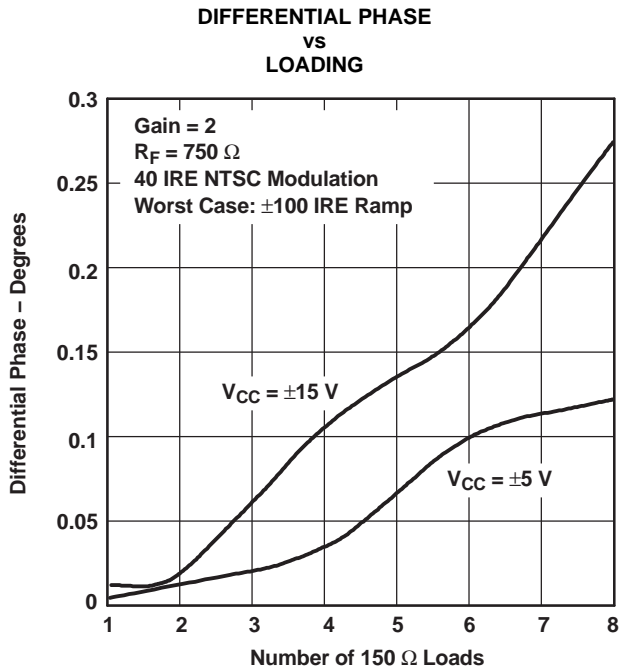

Figure 24.

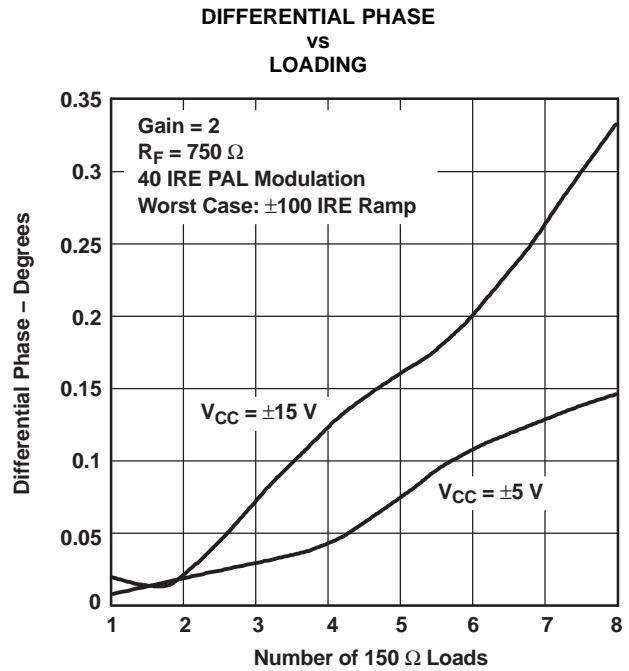

Figure 25.

TYPICAL CHARACTERISTICS (continued)

OUTPUT AMPLITUDE  
vs  
FREQUENCY

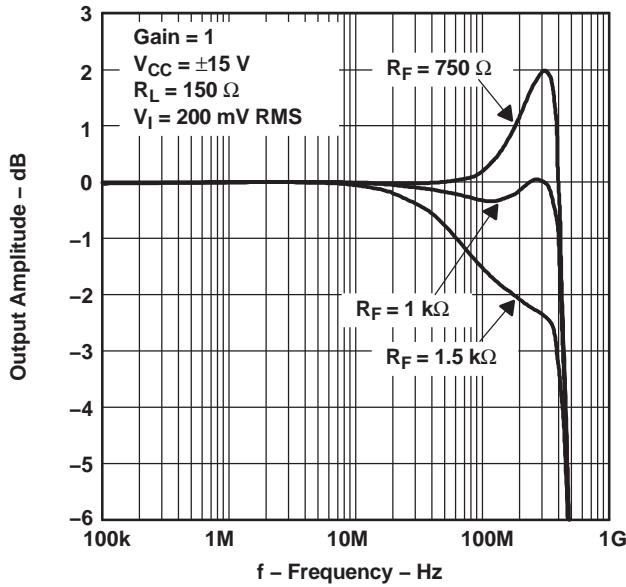

Figure 26.

OUTPUT AMPLITUDE  
vs  
FREQUENCY

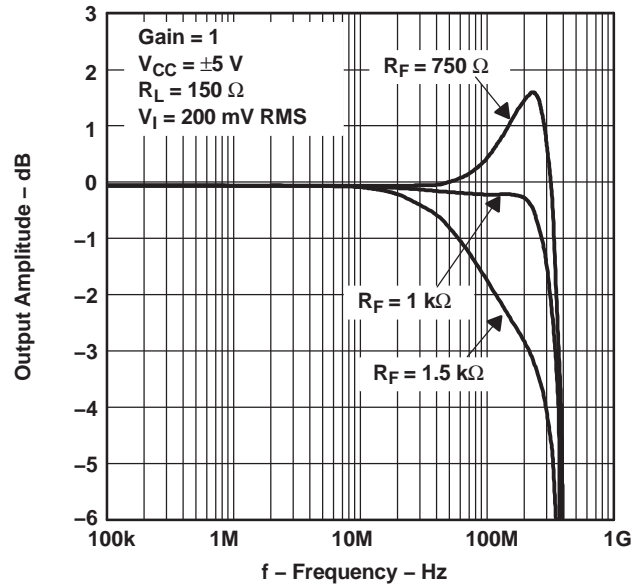

Figure 27.

OUTPUT AMPLITUDE  
vs  
FREQUENCY

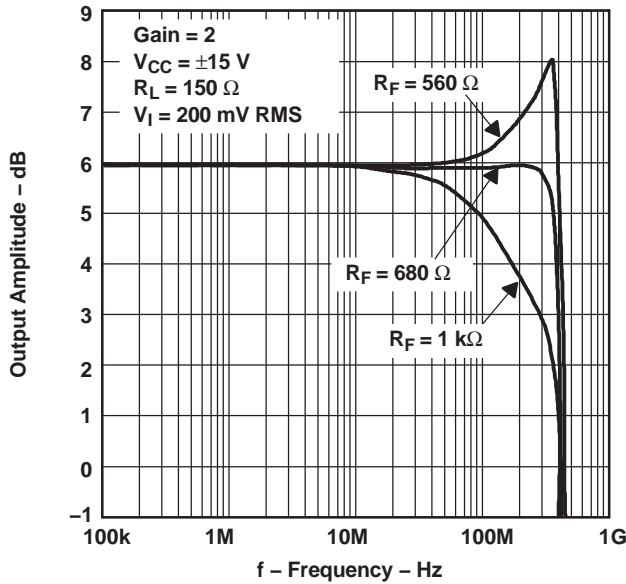

Figure 28.

OUTPUT AMPLITUDE  
vs  
FREQUENCY

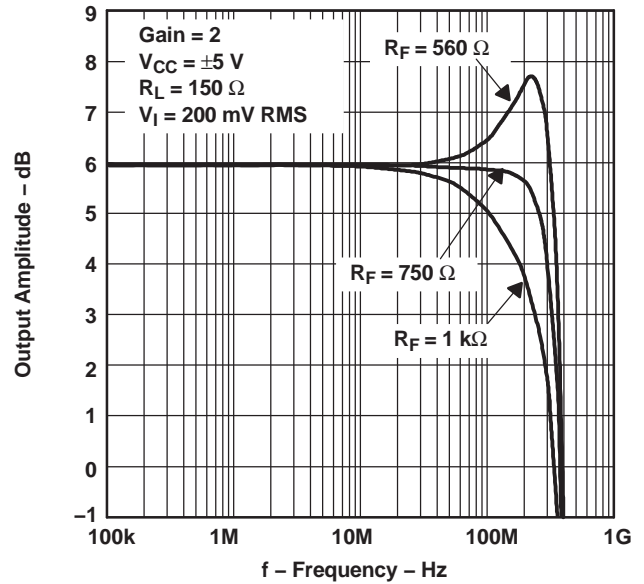

Figure 29.

TYPICAL CHARACTERISTICS (continued)

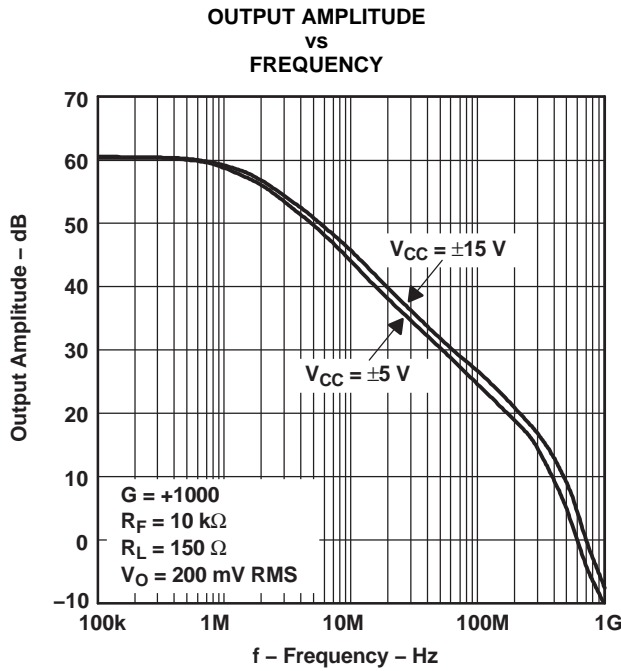

Figure 30.

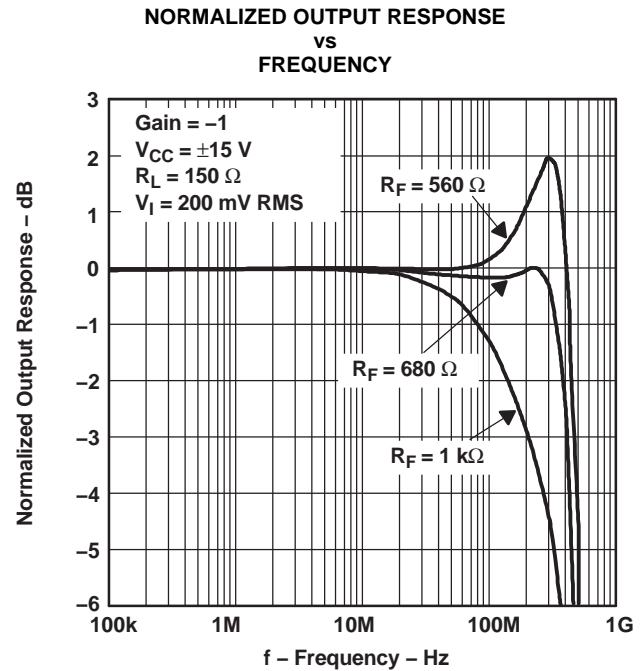

Figure 31.

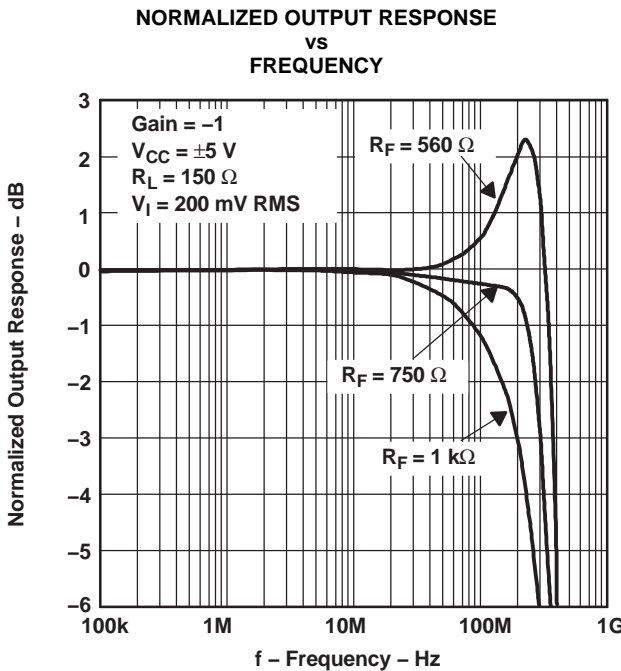

Figure 32.

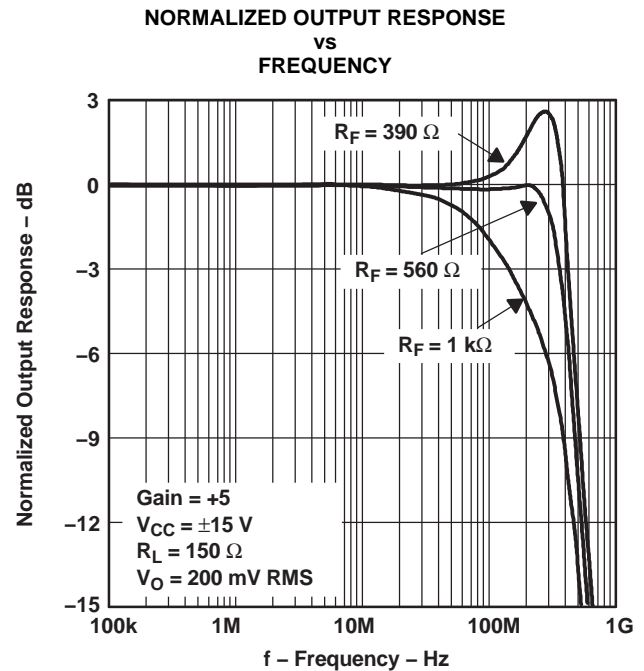

Figure 33.

TYPICAL CHARACTERISTICS (continued)

NORMALIZED OUTPUT RESPONSE  
vs  
FREQUENCY

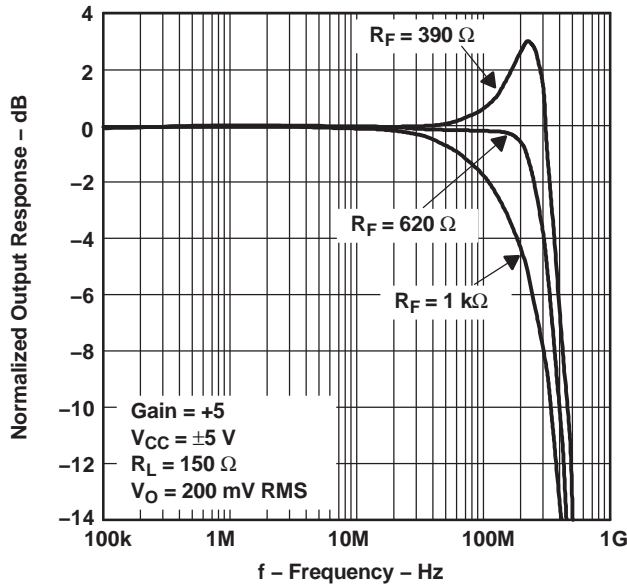

Figure 34.

SMALL AND LARGE SIGNAL  
FREQUENCY RESPONSE

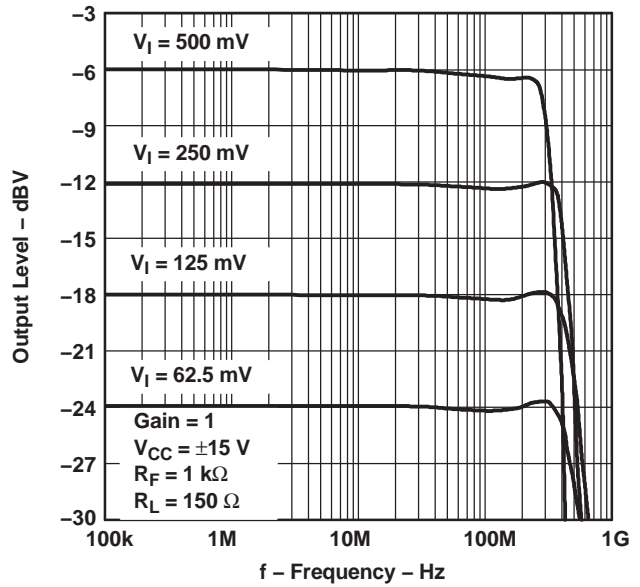

Figure 35.

SMALL AND LARGE SIGNAL  
FREQUENCY RESPONSE

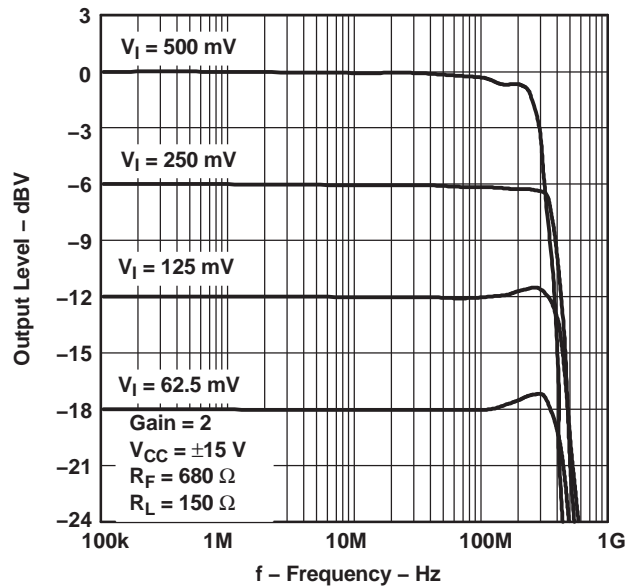

Figure 36.

SMALL SIGNAL PULSE RESPONSE

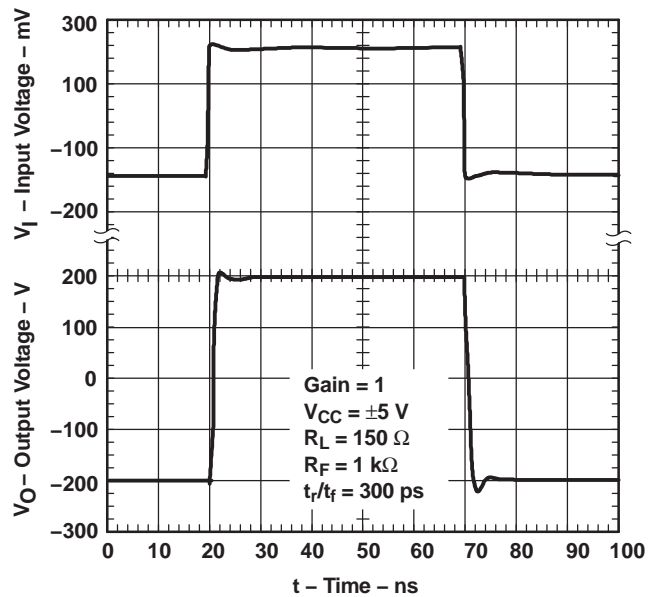

Figure 37.

TYPICAL CHARACTERISTICS (continued)

SMALL SIGNAL PULSE RESPONSE

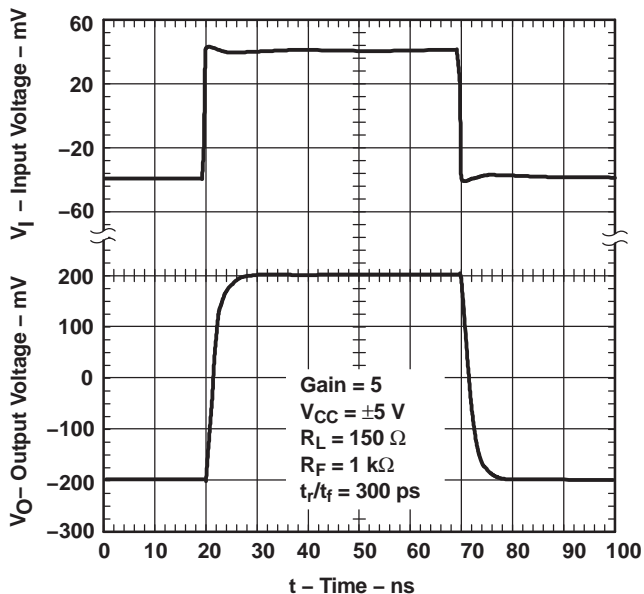

Figure 38.

LARGE SIGNAL PULSE RESPONSE

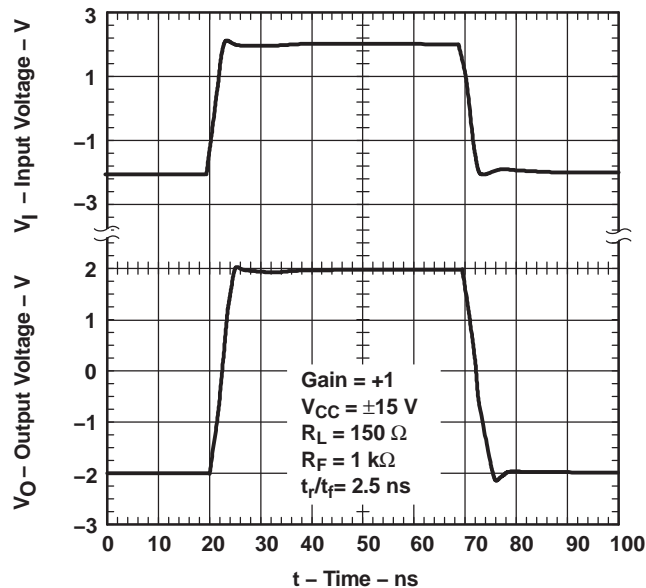

Figure 39.

LARGE SIGNAL PULSE RESPONSE

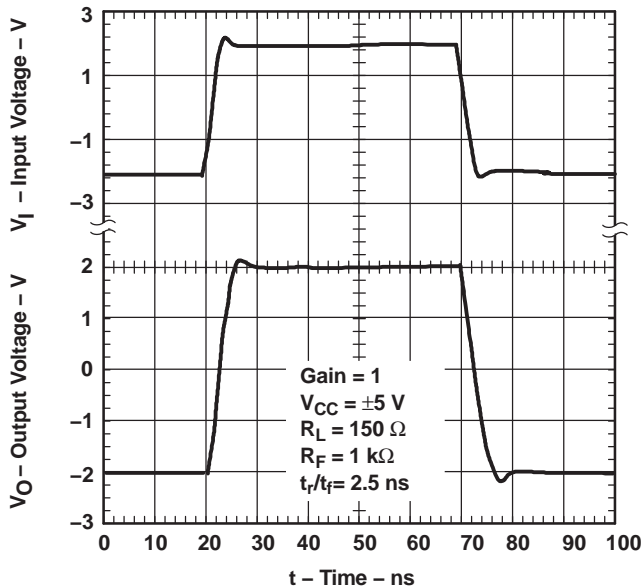

Figure 40.

LARGE SIGNAL PULSE RESPONSE

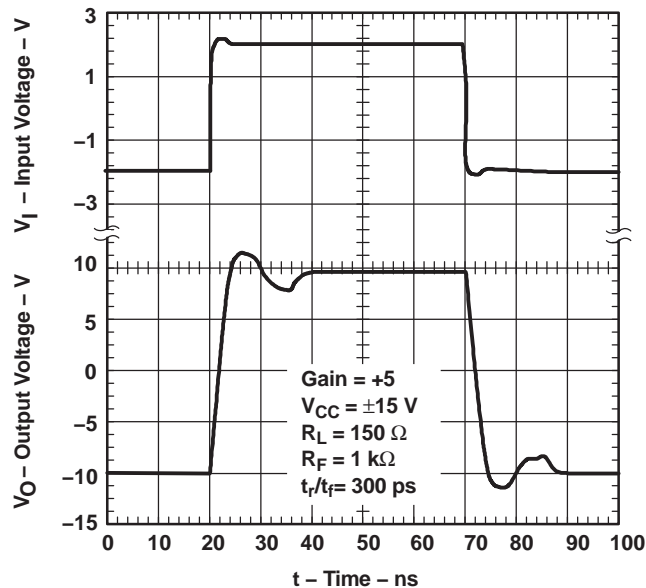

Figure 41.

TYPICAL CHARACTERISTICS (continued)

LARGE SIGNAL PULSE RESPONSE

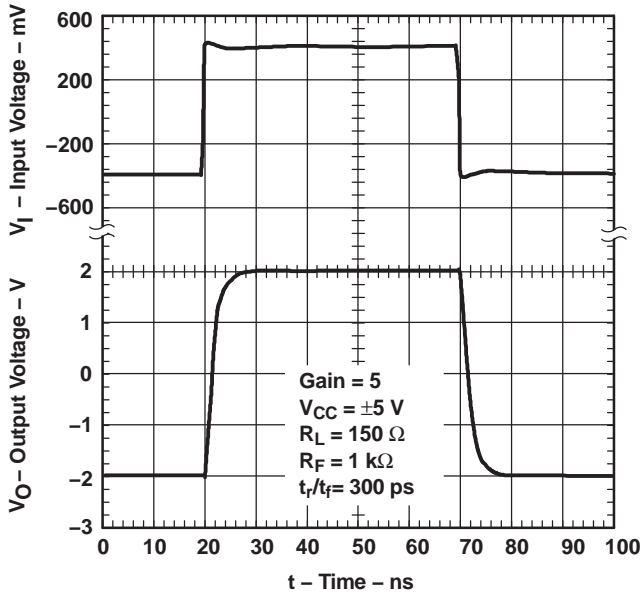

Figure 42.

LARGE SIGNAL PULSE RESPONSE

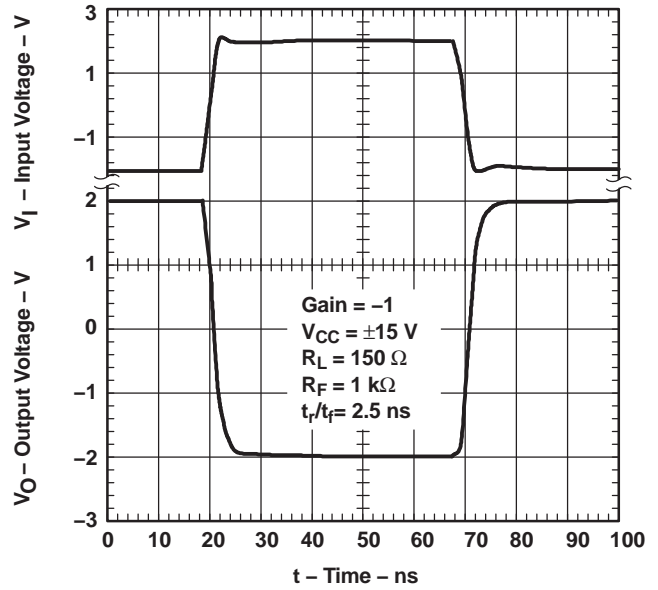

Figure 43.

LARGE SIGNAL PULSE RESPONSE

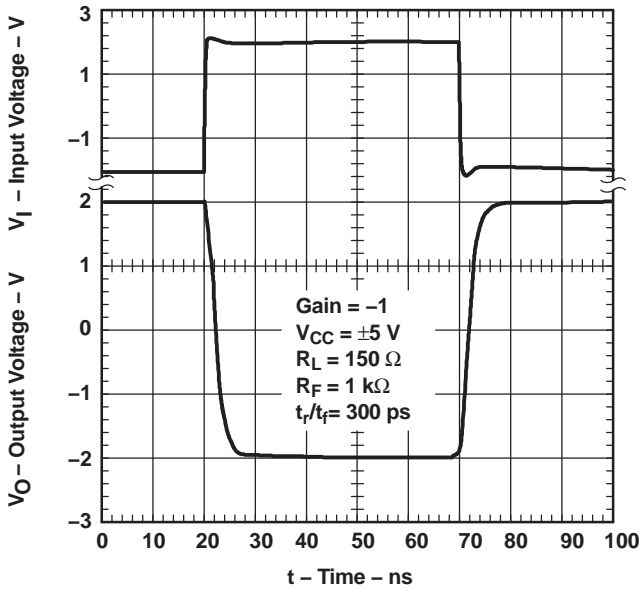

Figure 44.

LARGE SIGNAL PULSE RESPONSE

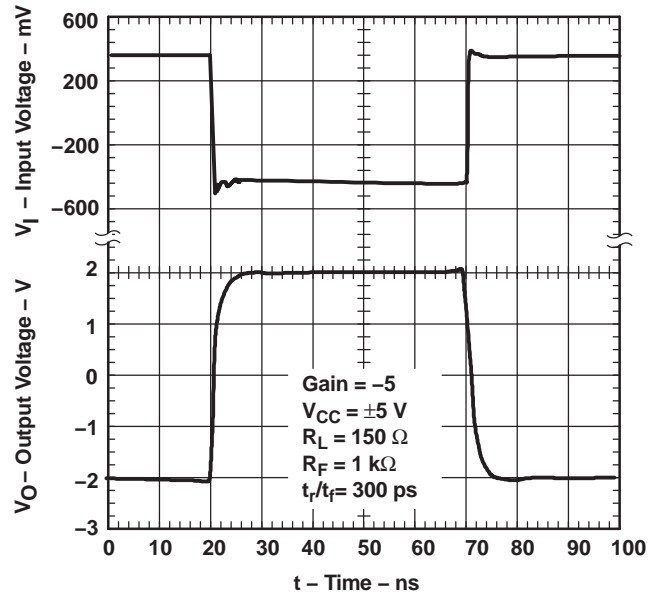
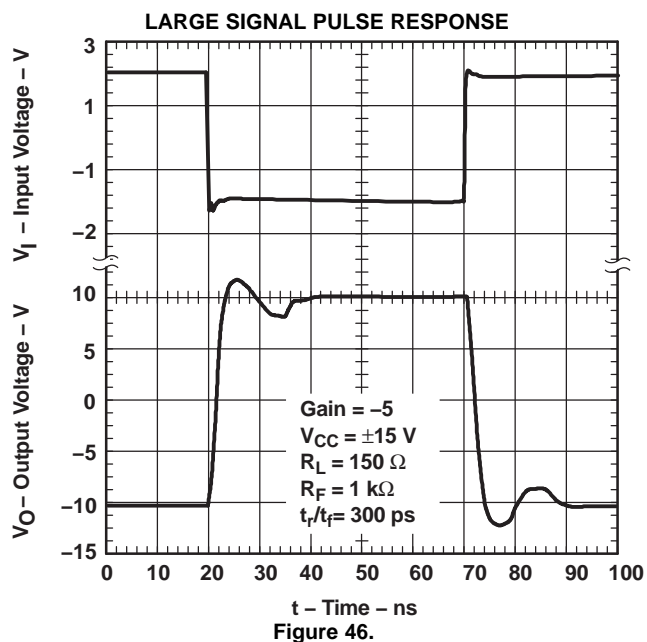

Figure 45.



TYPICAL CHARACTERISTICS (continued)



APPLICATION INFORMATION

THEORY OF OPERATION

The THS3001 is a high-speed, operational amplifier configured in a current-feedback architecture. The device is built using a 30-V, dielectrically isolated, complementary bipolar process with NPN and PNP transistors possessing  $f_T$ s of several GHz. This configuration implements an exceptionally high-performance amplifier that has a wide bandwidth, high slew rate, fast settling time, and low distortion. A simplified schematic is shown in Figure 47.

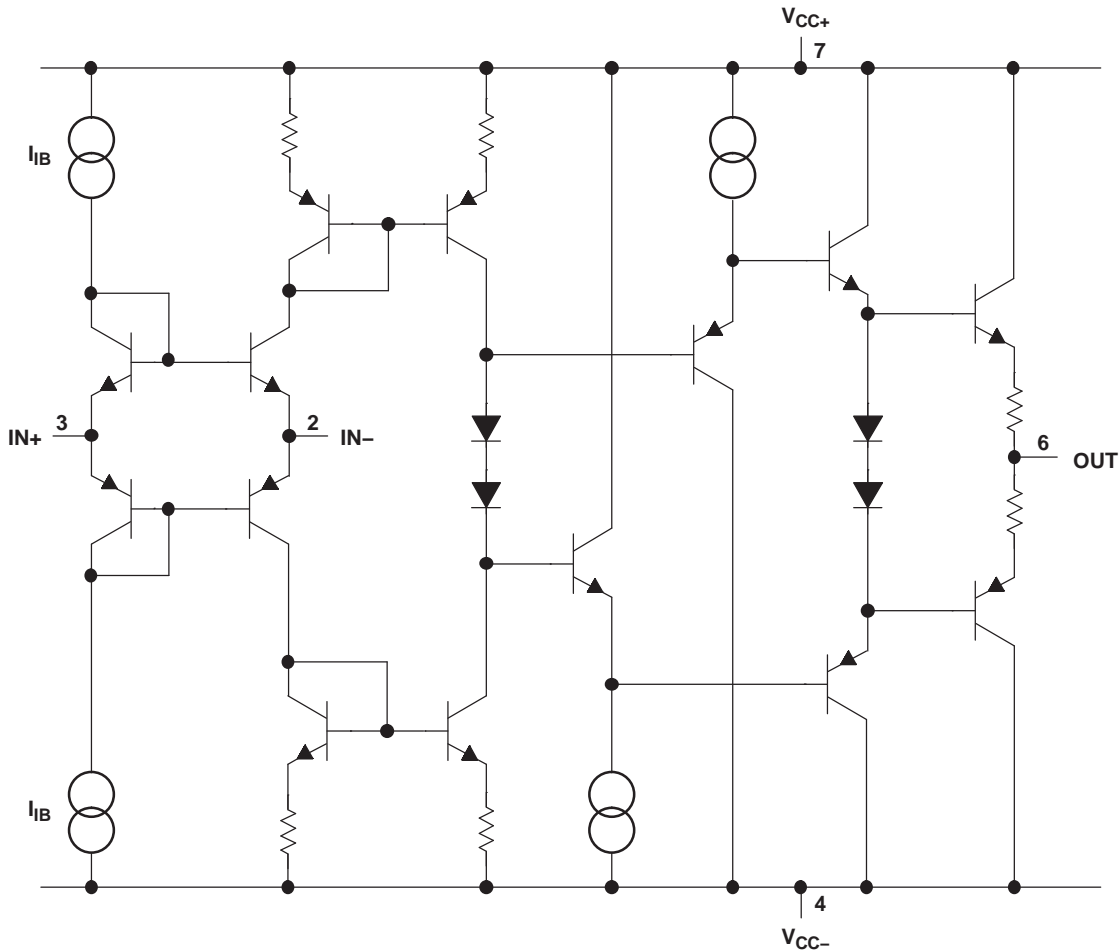

Figure 47. Simplified Schematic

## RECOMMENDED FEEDBACK AND GAIN RESISTOR VALUES

The THS3001 is fabricated using Texas Instruments 30-V complementary bipolar process, HVBiCOM. This process provides the excellent isolation and extremely high slew rates that result in superior distortion characteristics.

As with all current-feedback amplifiers, the bandwidth of the THS3001 is an inversely proportional function of the value of the feedback resistor (see Figures 26 to 34). The recommended resistors for the optimum frequency response are shown in Table 1. These should be used as a starting point and once optimum values are found, 1% tolerance resistors should be used to maintain frequency response characteristics. For most applications, a feedback resistor value of 1 kΩ is recommended - a good compromise between bandwidth and phase margin that yields a stable amplifier.

Consistent with current-feedback amplifiers, increasing the gain is best accomplished by changing the gain resistor, not the feedback resistor. This is because the bandwidth of the amplifier is dominated by the feedback resistor value and internal dominant-pole capacitor. The ability to control the amplifier gain independent of the bandwidth constitutes a major advantage of current-feedback amplifiers over conventional voltage-feedback amplifiers. Therefore, once a frequency response is found suitable to a particular application, adjust the value of the gain resistor to increase or decrease the overall amplifier gain.

Finally, it is important to realize the effects of the feedback resistance on distortion. Increasing the resistance decreases the loop gain and increases the distortion. It is also important to know that decreasing load impedance increases total harmonic distortion (THD). Typically, the third-order harmonic distortion increases more than the second-order harmonic distortion.

**Table 1. Recommended Resistor Values for Optimum Frequency Response**

GAIN	R <sub>F</sub> for V <sub>CC</sub> = ±15 V	R <sub>F</sub> for V <sub>CC</sub> = ±5 V
1	1 kΩ	1 kΩ
2, -1	680 Ω	750 Ω
2	620 Ω	620 Ω
5	560 Ω	620 Ω

## OFFSET VOLTAGE

The output offset voltage, (V<sub>OO</sub>) is the sum of the input offset voltage (V<sub>IO</sub>) and both input bias currents (I<sub>IB</sub>) times the corresponding gains. The following schematic and formula can be used to calculate the output offset voltage:

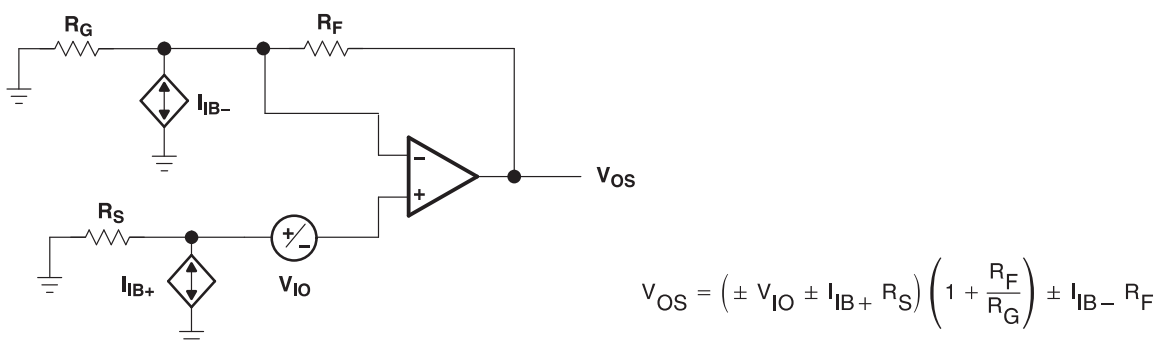
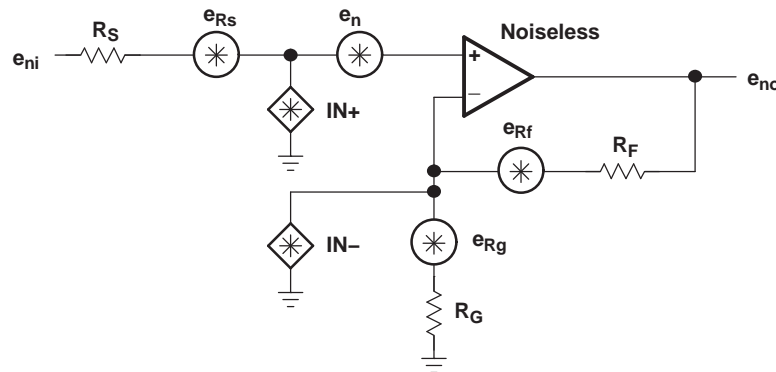

**Figure 48. Output Offset Voltage Model**

## NOISE CALCULATIONS

Noise can cause errors on small signals. This is especially true for amplifying small signals coming over a transmission line or an antenna. The noise model for current-feedback amplifiers (CFB) is the same as for voltage feedback amplifiers (VFB). The only difference between the two is that CFB amplifiers generally specify different current-noise parameters for each input, while VFB amplifiers usually only specify one noise-current parameter. The noise model is shown in Figure 49. This model includes all of the noise sources as follows:

- $e_n$  = Amplifier internal voltage noise ( $\text{nV}/\sqrt{\text{Hz}}$ )
- $IN+$  = Nonverting current noise ( $\text{pA}/\sqrt{\text{Hz}}$ )
- $IN-$  = Inverting current noise ( $\text{pA}/\sqrt{\text{Hz}}$ )
- $e_{R_x}$  = Thermal voltage noise associated with each resistor ( $e_{R_x} = 4 \text{ kTR}_x$ )



**Figure 49. Noise Model**

The total equivalent input noise density ( $e_{ni}$ ) is calculated by using the following equation:

$$e_{ni} = \sqrt{(e_n)^2 + (IN+ \times R_S)^2 + (IN- \times (R_F \parallel R_G))^2 + 4 \text{ kTR}_S + 4 \text{ kT}(R_F \parallel R_G)}$$

Where:

- $k$  = Boltzmann's constant =  $1.380658 \times 10^{-23}$
- $T$  = Temperature in degrees Kelvin ( $273 + ^\circ\text{C}$ )
- $R_F \parallel R_G$  = Parallel resistance of  $R_F$  and  $R_G$

To get the equivalent output noise of the amplifier, just multiply the equivalent input noise density ( $e_{ni}$ ) by the overall amplifier gain ( $A_V$ ).

$$e_{no} = e_{ni} A_V = e_{ni} \left( 1 + \frac{R_F}{R_G} \right) \text{ (Noninverting Case)}$$

As the previous equations show, to keep noise at a minimum, small value resistors should be used. As the closed-loop gain is increased (by reducing  $R_G$ ), the input noise is reduced considerably because of the parallel resistance term. This leads to the general conclusion that the most dominant noise sources are the source resistor ( $R_S$ ) and the internal amplifier noise voltage ( $e_n$ ). Because noise is summed in a root-mean-squares method, noise sources smaller than 25% of the largest noise source can be effectively ignored. This can greatly simplify the formula and make noise calculations much easier.

## SLEW RATE

The slew rate performance of a current-feedback amplifier, like the THS3001, is affected by many different factors. Some of these factors are external to the device, such as amplifier configuration and PCB parasitics, and others are internal to the device, such as available currents and node capacitance. Understanding some of these factors should help the PCB designer arrive at a more optimum circuit with fewer problems.

Whether the THS3001 is used in an inverting amplifier configuration or a noninverting configuration can impact the output slew rate. As can be seen from the specification tables as well as some of the figures in this data sheet, slew-rate performance in the inverting configuration is faster than in the noninverting configuration. This is because in the inverting configuration the input terminals of the amplifier are at a virtual ground and do not significantly change voltage as the input changes. Consequently, the time to charge any capacitance on these input nodes is less than for the noninverting configuration, where the input nodes actually do change in voltage an amount equal to the size of the input step. In addition, any PCB parasitic capacitance on the input nodes degrades the slew rate further simply because there is more capacitance to charge. Also, if the supply voltage ( $V_{CC}$ ) to the amplifier is reduced, slew rate decreases because there is less current available within the amplifier to charge the capacitance on the input nodes as well as other internal nodes.

Internally, the THS3001 has other factors that impact the slew rate. The amplifier's behavior during the slew-rate transition varies slightly depending upon the rise time of the input. This is because of the way the input stage handles faster and faster input edges. Slew rates (as measured at the amplifier output) of less than about 1500 V/ $\mu$ s are processed by the input stage in a linear fashion. Consequently, the output waveform smoothly transitions between initial and final voltage levels. This is shown in Figure 50. For slew rates greater than 1500 V/ $\mu$ s, additional slew-enhancing transistors present in the input stage begin to turn on to support these faster signals. The result is an amplifier with extremely fast slew-rate capabilities. Figure 50 and Figure 51 show waveforms for these faster slew rates. The additional aberrations present in the output waveform with these faster-slewing input signals are due to the brief saturation of the internal current mirrors. This phenomenon, which typically lasts less than 20 ns, is considered normal operation and is not detrimental to the device in any way. If for any reason this type of response is not desired, then increasing the feedback resistor or slowing down the input-signal slew rate reduces the effect.

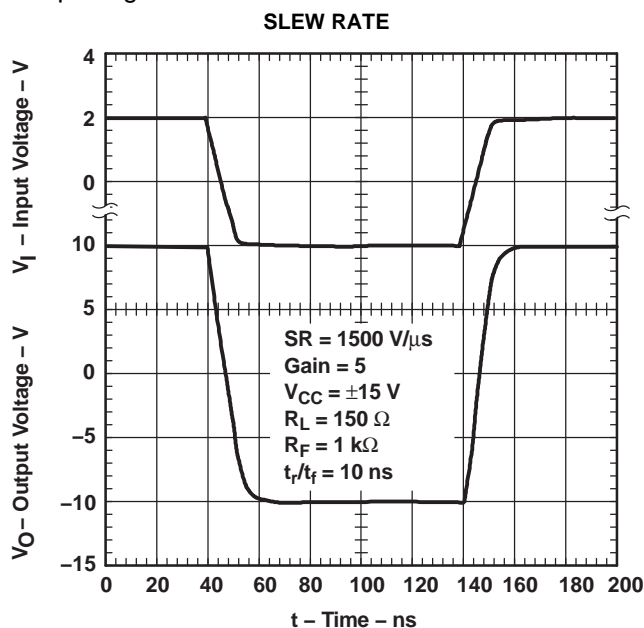

Figure 50.

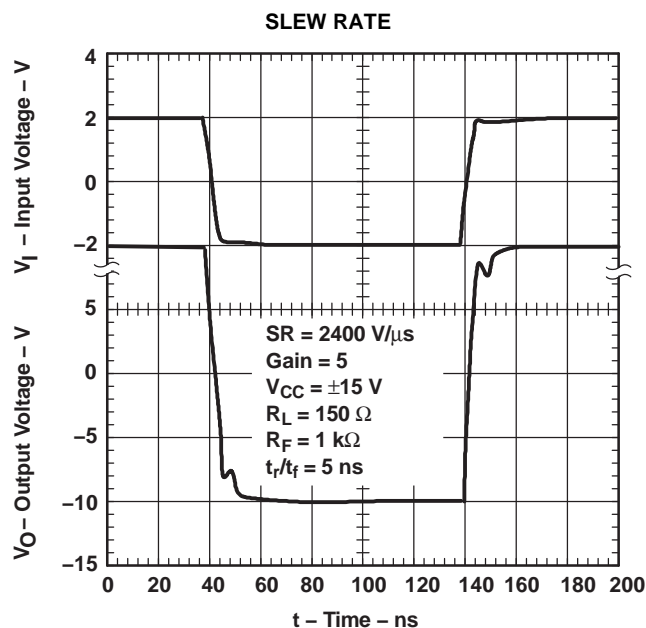

Figure 51.

## DRIVING A CAPACITIVE LOAD

Driving capacitive loads with high-performance amplifiers is not a problem as long as certain precautions are taken. The first is to realize that the THS3001 has been internally compensated to maximize its bandwidth and slew-rate performance. When the amplifier is compensated in this manner, capacitive loading directly on the output will decrease the device's phase margin leading to high-frequency ringing or oscillations. Therefore, for capacitive loads of greater than 10 pF, it is recommended that a resistor be placed in series with the output of the amplifier, as shown in Figure 52. A minimum value of  $20\Omega$  should work well for most applications. For example, in  $75\Omega$  transmission systems, setting the series resistor value to  $75\Omega$  both isolates any capacitance loading and provides the proper line impedance matching at the source end.

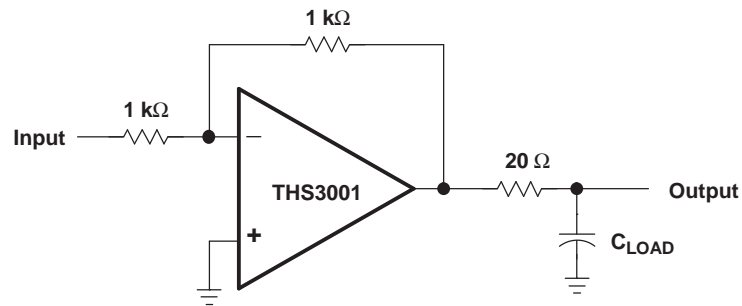

Figure 52. Driving a Capacitive Load

## PCB DESIGN CONSIDERATIONS

Proper PCB design techniques in two areas are important to ensure proper operation of the THS3001. These areas are high-speed layout techniques and thermal-management techniques. Because the THS3001 is a high-speed part, the following guidelines are recommended.

- Ground plane - It is essential that a ground plane be used on the board to provide all components with a low inductive ground connection, but should be removed from below the output and negative input pins as noted below.
- The DGN package option includes a thermal pad for increased thermal performance. When using this package, it is recommended to distribute the negative supply as a power plane, and tie the thermal pad to this supply with multiple vias for proper power dissipation. It is not recommended to tie the thermal pad to ground when using split supply ( $\pm V$ ) as this will cause worse distortion performance than shown in this data sheet.
- Input stray capacitance - To minimize potential problems with amplifier oscillation, the capacitance at the inverting input of the amplifiers must be kept to a minimum. To do this, PCB trace runs to the inverting input must be as short as possible, the ground plane must be removed under any etch runs connected to the inverting input, and external components should be placed as close as possible to the inverting input. This is especially true in the noninverting configuration. An example of this can be seen in [Figure 53](#), which shows what happens when a 1-pF capacitor is added to the inverting input terminal. The bandwidth increases at the expense of peaking. This is because some of the error current is flowing through the stray capacitor instead of the inverting node of the amplifier. Although, while the device is in the inverting mode, stray capacitance at the inverting input has a minimal effect. This is because the inverting node is at a *virtual ground* and the voltage does not fluctuate nearly as much as in the noninverting configuration. This can be seen in [Figure 54](#), where a 10-pF capacitor adds only 0.35 dB of peaking. In general, as the gain of the system increases, the output peaking due to this capacitor decreases. While this can initially look like a faster and better system, overshoot and ringing are more likely to occur under fast transient conditions. So proper analysis of adding a capacitor to the inverting input node should be performed for stable operation.

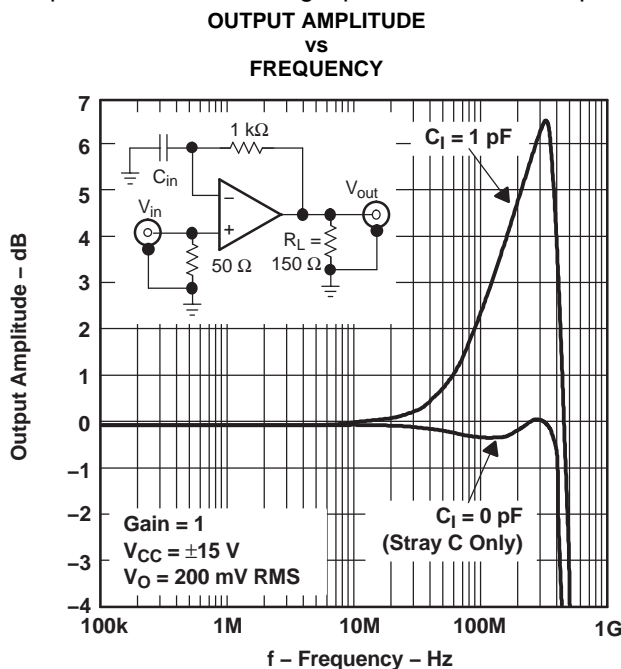

Figure 53.

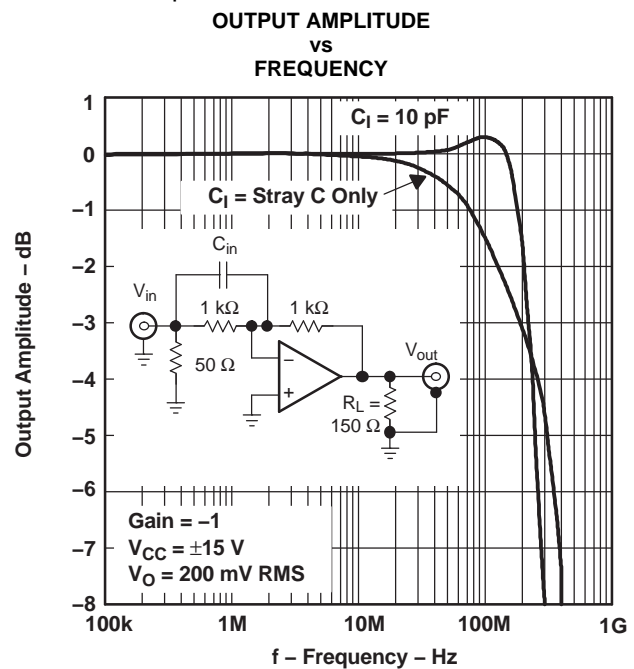

Figure 54.

- Proper power-supply decoupling - Use a minimum 6.8- $\mu$ F tantalum capacitor in parallel with a 0.1- $\mu$ F ceramic capacitor on each supply terminal. It may be possible to share the tantalum among several amplifiers depending on the application, but a 0.1- $\mu$ F ceramic capacitor should always be used on the supply terminal of every amplifier. In addition, the 0.1- $\mu$ F capacitor should be placed as close as possible to the supply terminal. As this distance increases, the inductance in the connecting etch makes the capacitor less effective. The designer should strive for distances of less than 0.1 inch between the device power terminal and the ceramic capacitors.

## THERMAL INFORMATION

The THS3001 incorporates output-current-limiting protection. Should the output become shorted to ground, the output current is automatically limited to the value given in the data sheet. While this protects the output against excessive current, the device internal power dissipation increases due to the high current and large voltage drop across the output transistors. Continuous output shorts are not recommended and could damage the device. Additionally, connection of the amplifier output to one of the supply rails ( $\pm V_{CC}$ ) is not recommended. Failure of the device is possible under this condition and should be avoided. But, the THS3001 does not incorporate thermal-shutdown protection. Because of this, special attention must be paid to the device's power dissipation or failure may result.

The thermal coefficient  $\theta_{JA}$  is approximately 169°C/W for the SOIC 8-pin D package. For a given  $\theta_{JA}$ , the maximum power dissipation, shown in [Figure 55](#), is calculated by the following formula:

$$P_D = \left( \frac{T_{MAX} - T_A}{\theta_{JA}} \right)$$

Where:

- $P_D$  = Maximum power dissipation of THS3001 (watts)
- $T_{MAX}$  = Absolute maximum junction temperature (150°C)
- $T_A$  = Free-ambient air temperature (°C)
- $\theta_{JA}$  = Thermal coefficient from die junction to ambient air (°C/W)

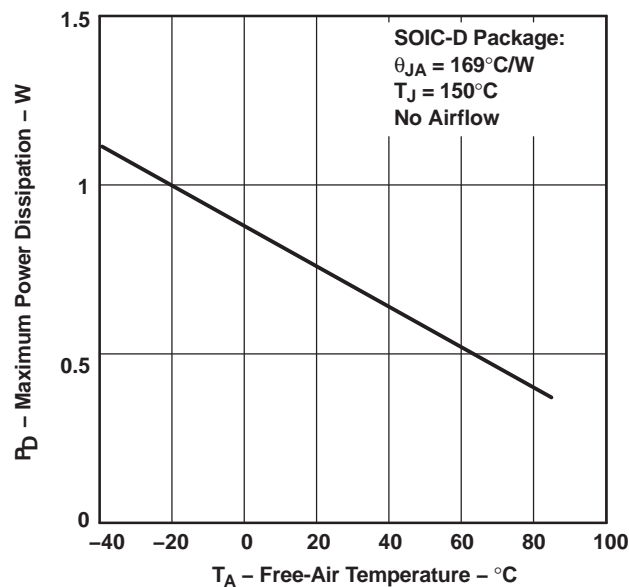

**Figure 55. Maximum Power Dissipation vs Free-Air Temperature**



## GENERAL CONFIGURATIONS

A common error for the first-time CFB user is the creation of a unity gain buffer amplifier by shorting the output directly to the inverting input. A CFB amplifier in this configuration will oscillate and is *not* recommended. The THS3001, like all CFB amplifiers, *must* have a feedback resistor for stable operation. Additionally, placing capacitors directly from the output to the inverting input is not recommended. This is because, at high frequencies, a capacitor has a low impedance. This results in an unstable amplifier and should not be considered when using a current-feedback amplifier. Because of this, integrators and simple low-pass filters, which are easily implemented on a VFB amplifier, have to be designed slightly differently. If filtering is required, simply place an RC-filter at the noninverting terminal of the operational-amplifier (see [Figure 56](#)).

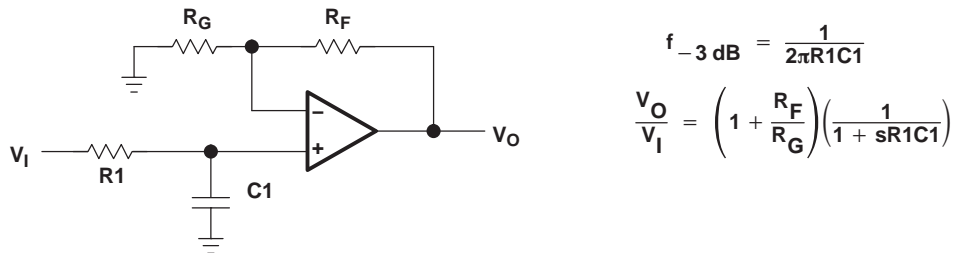

Figure 56. Single-Pole Low-Pass Filter

If a multiple-pole filter is required, the use of a Sallen-Key filter can work well with CFB amplifiers. This is because the filtering elements are not in the negative feedback loop and stability is not compromised. Because of their high slew rates and high bandwidths, CFB amplifiers can create accurate signals and help minimize distortion. An example is shown in [Figure 57](#).

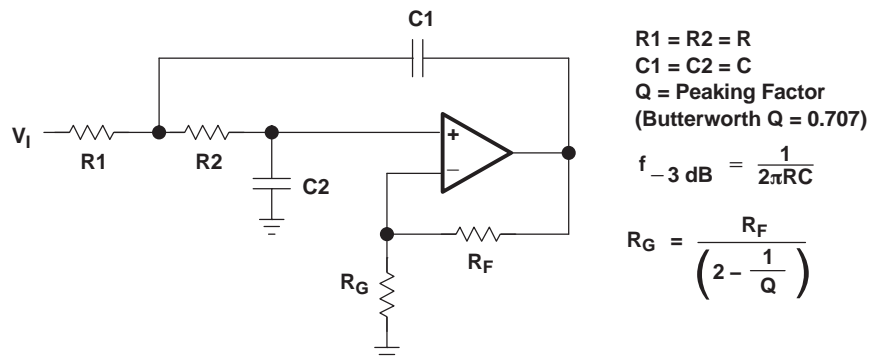

Figure 57. 2-Pole Low-Pass Sallen-Key Filter

There are two simple ways to create an integrator with a CFB amplifier. The first, shown in [Figure 58](#), adds a resistor in series with the capacitor. This is acceptable because at high frequencies, the resistor is dominant and the feedback impedance never drops below the resistor value. The second, shown in [Figure 59](#), uses positive feedback to create the integration. Caution is advised because oscillations can occur due to the positive feedback.

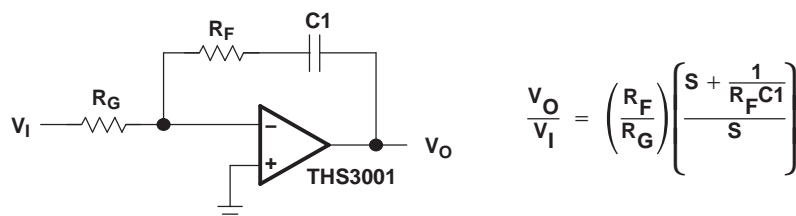
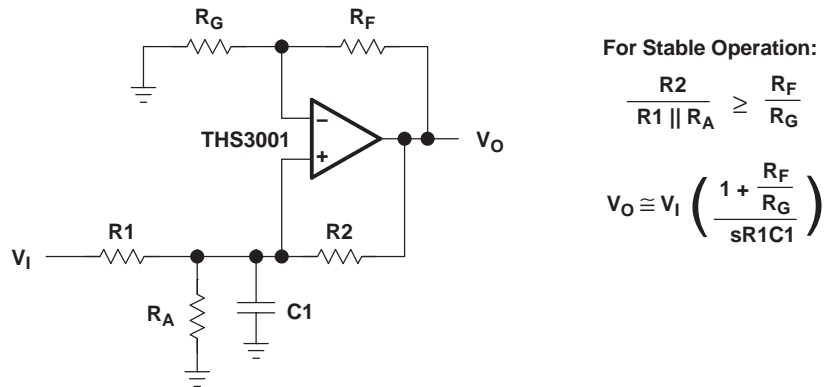

Figure 58. Inverting CFB Integrator



For Stable Operation:

$$\frac{R2}{R1 \parallel R_A} \geq \frac{R_F}{R_G}$$

$$V_O \cong V_I \left( \frac{1 + \frac{R_F}{R_G}}{sR1C1} \right)$$

Figure 59. Noninverting CFB Integrator

The THS3001 may also be employed as a good video distribution amplifier. One characteristic of distribution amplifiers is the fact that the differential phase (DP) and the differential gain (DG) are compromised as the number of lines increases and the closed-loop gain increases (see Figures 22 to 25 for more information). Be sure to use termination resistors throughout the distribution system to minimize reflections and capacitive loading.

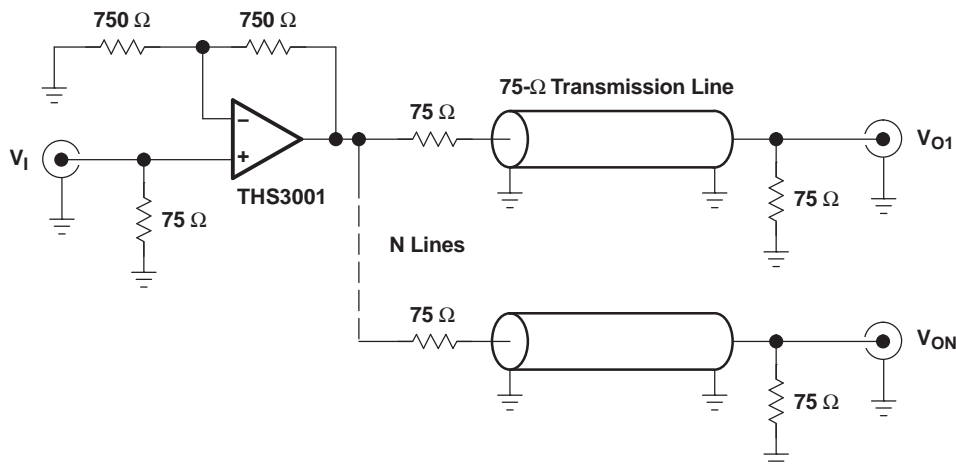

Figure 60. Video Distribution Amplifier Application

## EVALUATION BOARD

An evaluation board is available for the THS3001 ([THS3001EVM](#)). The board has been configured for low parasitic capacitance in order to realize the full performance of the amplifier. A schematic of the evaluation board is shown in [Figure 61](#). The circuitry has been designed so that the amplifier may be used in either an inverting or noninverting configuration. For more detailed information, refer to the *THS3001 EVM User's Guide* (literature number [SLOU021](#)). The evaluation board can be ordered online through the [TI web site](#), or through your local TI sales office or distributor.

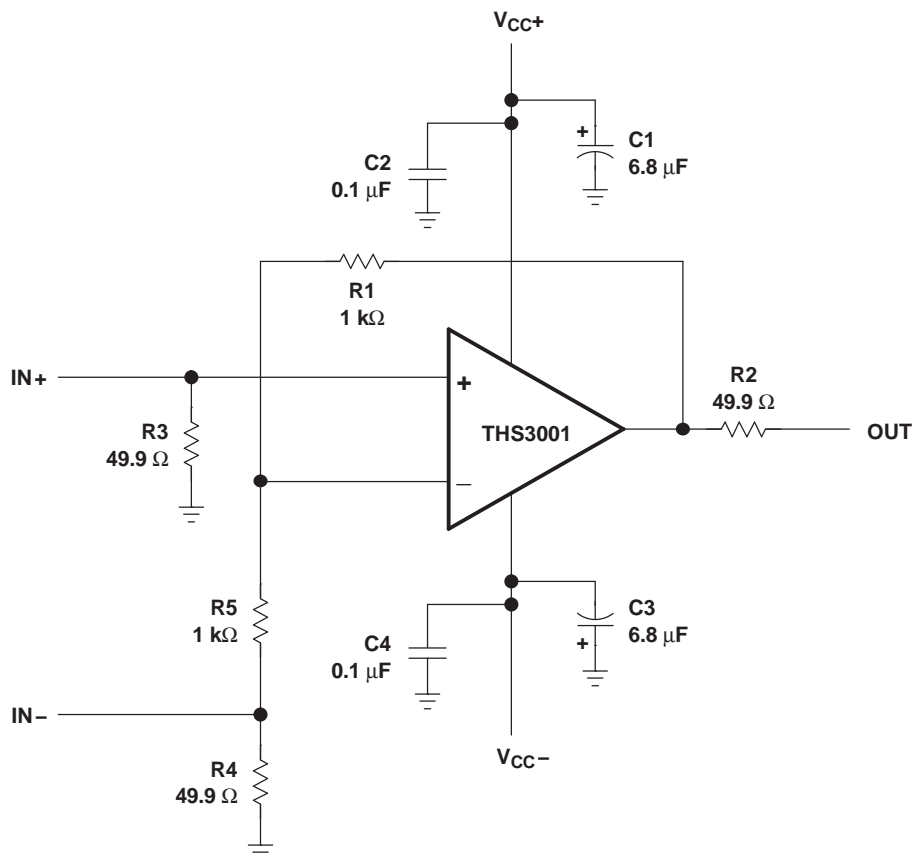

Figure 61. THS3001 Evaluation Board Schematic

## REVISION HISTORY

NOTE: Page numbers for previous revisions may differ from page numbers in the current version.

<b>Changes from Revision G (March, 2008) to Revision H</b>	<b>Page</b>
• Updated document format to current standards .....	<a href="#">1</a>
• Deleted references to HV version in SOIC package; this version is not available .....	<a href="#">2</a>
• Updated information about THS3001EVM availability .....	<a href="#">27</a>

**PACKAGING INFORMATION**

Orderable Device	Status (1)	Package Type	Package Drawing	Pins	Package Qty	Eco Plan (2)	Lead/Ball Finish (6)	MSL Peak Temp (3)	Op Temp (°C)	Device Marking (4/5)	Samples
THS3001CD	ACTIVE	SOIC	D	8	75	Green (RoHS & no Sb/Br)	CU NIPDAU	Level-1-260C-UNLIM	0 to 70	3001C	<a href="#">Samples</a>
THS3001CDG4	ACTIVE	SOIC	D	8	75	Green (RoHS & no Sb/Br)	CU NIPDAU	Level-1-260C-UNLIM	0 to 70	3001C	<a href="#">Samples</a>
THS3001CDGN	ACTIVE	MSOP-PowerPAD	DGN	8	80	Green (RoHS & no Sb/Br)	CU NIPDAU   CU NIPDAUAG	Level-1-260C-UNLIM	0 to 70	ADP	<a href="#">Samples</a>
THS3001CDGNR	ACTIVE	MSOP-PowerPAD	DGN	8	2500	Green (RoHS & no Sb/Br)	CU NIPDAU   CU NIPDAUAG	Level-1-260C-UNLIM	0 to 70	ADP	<a href="#">Samples</a>
THS3001CDR	ACTIVE	SOIC	D	8	2500	Green (RoHS & no Sb/Br)	CU NIPDAU	Level-1-260C-UNLIM	0 to 70	3001C	<a href="#">Samples</a>
THS3001CDRG4	ACTIVE	SOIC	D	8	2500	Green (RoHS & no Sb/Br)	CU NIPDAU	Level-1-260C-UNLIM	0 to 70	3001C	<a href="#">Samples</a>
THS3001HVCDGN	ACTIVE	MSOP-PowerPAD	DGN	8	80	Green (RoHS & no Sb/Br)	CU NIPDAU	Level-1-260C-UNLIM	0 to 70	BNK	<a href="#">Samples</a>
THS3001HVIDGN	ACTIVE	MSOP-PowerPAD	DGN	8	80	Green (RoHS & no Sb/Br)	CU NIPDAU   CU NIPDAUAG	Level-1-260C-UNLIM	-40 to 85	BNJ	<a href="#">Samples</a>
THS3001HVIDGNG4	ACTIVE	MSOP-PowerPAD	DGN	8	80	Green (RoHS & no Sb/Br)	CU NIPDAUAG	Level-1-260C-UNLIM	-40 to 85	BNJ	<a href="#">Samples</a>
THS3001ID	ACTIVE	SOIC	D	8	75	Green (RoHS & no Sb/Br)	CU NIPDAU	Level-1-260C-UNLIM		3001I	<a href="#">Samples</a>
THS3001IDG4	ACTIVE	SOIC	D	8	75	Green (RoHS & no Sb/Br)	CU NIPDAU	Level-1-260C-UNLIM		3001I	<a href="#">Samples</a>
THS3001IDGN	ACTIVE	MSOP-PowerPAD	DGN	8	80	Green (RoHS & no Sb/Br)	CU NIPDAU   CU NIPDAUAG	Level-1-260C-UNLIM		ADQ	<a href="#">Samples</a>
THS3001IDGNG4	ACTIVE	MSOP-PowerPAD	DGN	8	80	Green (RoHS & no Sb/Br)	CU NIPDAUAG	Level-1-260C-UNLIM		ADQ	<a href="#">Samples</a>
THS3001IDGNR	ACTIVE	MSOP-PowerPAD	DGN	8	2500	Green (RoHS & no Sb/Br)	CU NIPDAU   CU NIPDAUAG	Level-1-260C-UNLIM		ADQ	<a href="#">Samples</a>
THS3001IDR	ACTIVE	SOIC	D	8	2500	Green (RoHS & no Sb/Br)	CU NIPDAU	Level-1-260C-UNLIM		3001I	<a href="#">Samples</a>

(1) The marketing status values are defined as follows:

**ACTIVE:** Product device recommended for new designs.

**LIFEBUY:** TI has announced that the device will be discontinued, and a lifetime-buy period is in effect.

**NRND:** Not recommended for new designs. Device is in production to support existing customers, but TI does not recommend using this part in a new design.

---

**PREVIEW:** Device has been announced but is not in production. Samples may or may not be available.

**OBSELETE:** TI has discontinued the production of the device.

<sup>(2)</sup> **RoHS:** TI defines "RoHS" to mean semiconductor products that are compliant with the current EU RoHS requirements for all 10 RoHS substances, including the requirement that RoHS substance do not exceed 0.1% by weight in homogeneous materials. Where designed to be soldered at high temperatures, "RoHS" products are suitable for use in specified lead-free processes. TI may reference these types of products as "Pb-Free".

**RoHS Exempt:** TI defines "RoHS Exempt" to mean products that contain lead but are compliant with EU RoHS pursuant to a specific EU RoHS exemption.

**Green:** TI defines "Green" to mean the content of Chlorine (Cl) and Bromine (Br) based flame retardants meet JS709B low halogen requirements of  $\leq 1000$ ppm threshold. Antimony trioxide based flame retardants must also meet the  $\leq 1000$ ppm threshold requirement.

<sup>(3)</sup> MSL, Peak Temp. - The Moisture Sensitivity Level rating according to the JEDEC industry standard classifications, and peak solder temperature.

<sup>(4)</sup> There may be additional marking, which relates to the logo, the lot trace code information, or the environmental category on the device.

<sup>(5)</sup> Multiple Device Markings will be inside parentheses. Only one Device Marking contained in parentheses and separated by a "~" will appear on a device. If a line is indented then it is a continuation of the previous line and the two combined represent the entire Device Marking for that device.

<sup>(6)</sup> Lead/Ball Finish - Orderable Devices may have multiple material finish options. Finish options are separated by a vertical ruled line. Lead/Ball Finish values may wrap to two lines if the finish value exceeds the maximum column width.

**Important Information and Disclaimer:** The information provided on this page represents TI's knowledge and belief as of the date that it is provided. TI bases its knowledge and belief on information provided by third parties, and makes no representation or warranty as to the accuracy of such information. Efforts are underway to better integrate information from third parties. TI has taken and continues to take reasonable steps to provide representative and accurate information but may not have conducted destructive testing or chemical analysis on incoming materials and chemicals. TI and TI suppliers consider certain information to be proprietary, and thus CAS numbers and other limited information may not be available for release.

In no event shall TI's liability arising out of such information exceed the total purchase price of the TI part(s) at issue in this document sold by TI to Customer on an annual basis.

**TAPE AND REEL INFORMATION**

**QUADRANT ASSIGNMENTS FOR PIN 1 ORIENTATION IN TAPE**

\*All dimensions are nominal

Device	Package Type	Package Drawing	Pins	SPQ	Reel Diameter (mm)	Reel Width W1 (mm)	A0 (mm)	B0 (mm)	K0 (mm)	P1 (mm)	W (mm)	Pin1 Quadrant
THS3001CDGNR	MSOP-Power PAD	DGN	8	2500	330.0	12.4	5.3	3.4	1.4	8.0	12.0	Q1
THS3001CDR	SOIC	D	8	2500	330.0	12.4	6.4	5.2	2.1	8.0	12.0	Q1
THS3001IDGNR	MSOP-Power PAD	DGN	8	2500	330.0	12.4	5.3	3.4	1.4	8.0	12.0	Q1
THS3001IDR	SOIC	D	8	2500	330.0	12.4	6.4	5.2	2.1	8.0	12.0	Q1

**TAPE AND REEL BOX DIMENSIONS**

\*All dimensions are nominal

Device	Package Type	Package Drawing	Pins	SPQ	Length (mm)	Width (mm)	Height (mm)
THS3001CDGNR	MSOP-PowerPAD	DGN	8	2500	364.0	364.0	27.0
THS3001CDR	SOIC	D	8	2500	350.0	350.0	43.0
THS3001IDGNR	MSOP-PowerPAD	DGN	8	2500	364.0	364.0	27.0
THS3001IDR	SOIC	D	8	2500	350.0	350.0	43.0





D0008A

# PACKAGE OUTLINE

SOIC - 1.75 mm max height

SMALL OUTLINE INTEGRATED CIRCUIT



4214825/C 02/2019

NOTES:

- Linear dimensions are in inches [millimeters]. Dimensions in parenthesis are for reference only. Controlling dimensions are in inches. Dimensioning and tolerancing per ASME Y14.5M.
- This drawing is subject to change without notice.
- This dimension does not include mold flash, protrusions, or gate burrs. Mold flash, protrusions, or gate burrs shall not exceed .006 [0.15] per side.
- This dimension does not include interlead flash.
- Reference JEDEC registration MS-012, variation AA.

# EXAMPLE BOARD LAYOUT

D0008A

SOIC - 1.75 mm max height

SMALL OUTLINE INTEGRATED CIRCUIT



LAND PATTERN EXAMPLE  
 EXPOSED METAL SHOWN  
 SCALE:8X



SOLDER MASK DETAILS

4214825/C 02/2019

NOTES: (continued)

- 6. Publication IPC-7351 may have alternate designs.
- 7. Solder mask tolerances between and around signal pads can vary based on board fabrication site.

# EXAMPLE STENCIL DESIGN

D0008A

SOIC - 1.75 mm max height

SMALL OUTLINE INTEGRATED CIRCUIT



SOLDER PASTE EXAMPLE  
BASED ON .005 INCH [0.125 MM] THICK STENCIL  
SCALE:8X

4214825/C 02/2019

NOTES: (continued)

8. Laser cutting apertures with trapezoidal walls and rounded corners may offer better paste release. IPC-7525 may have alternate design recommendations.
9. Board assembly site may have different recommendations for stencil design.

DGN (S-PDSO-G8)

PowerPAD™ PLASTIC SMALL OUTLINE

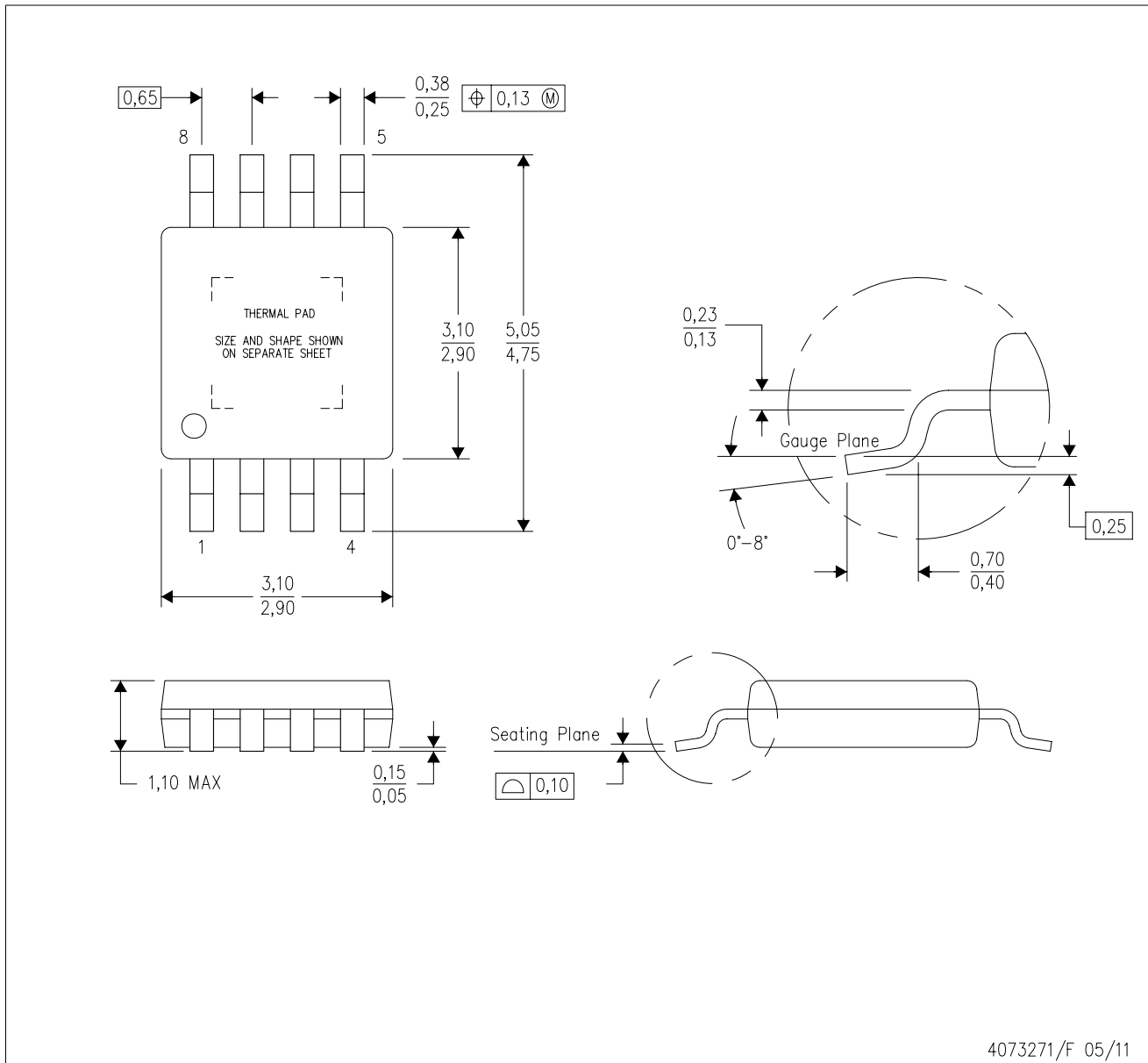

- NOTES:
- All linear dimensions are in millimeters.
  - This drawing is subject to change without notice.
  - Body dimensions do not include mold flash or protrusion.
  - This package is designed to be soldered to a thermal pad on the board. Refer to Technical Brief, PowerPad Thermally Enhanced Package, Texas Instruments Literature No. SLMA002 for information regarding recommended board layout. This document is available at [www.ti.com](http://www.ti.com) <<http://www.ti.com>>.
  - See the additional figure in the Product Data Sheet for details regarding the exposed thermal pad features and dimensions.
  - Falls within JEDEC MO-187 variation AA-T

PowerPAD is a trademark of Texas Instruments.

DGN (S-PDSO-G8)

PowerPAD™ PLASTIC SMALL OUTLINE

## THERMAL INFORMATION

This PowerPAD™ package incorporates an exposed thermal pad that is designed to be attached to a printed circuit board (PCB). The thermal pad must be soldered directly to the PCB. After soldering, the PCB can be used as a heatsink. In addition, through the use of thermal vias, the thermal pad can be attached directly to the appropriate copper plane shown in the electrical schematic for the device, or alternatively, can be attached to a special heatsink structure designed into the PCB. This design optimizes the heat transfer from the integrated circuit (IC).

For additional information on the PowerPAD package and how to take advantage of its heat dissipating abilities, refer to Technical Brief, PowerPAD Thermally Enhanced Package, Texas Instruments Literature No. SLMA002 and Application Brief, PowerPAD Made Easy, Texas Instruments Literature No. SLMA004. Both documents are available at [www.ti.com](http://www.ti.com).

The exposed thermal pad dimensions for this package are shown in the following illustration.

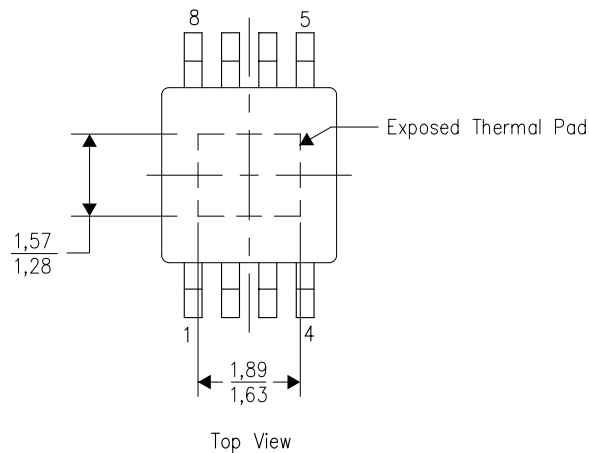

Exposed Thermal Pad Dimensions

4206323-2/1 12/11

NOTE: All linear dimensions are in millimeters

PowerPAD is a trademark of Texas Instruments

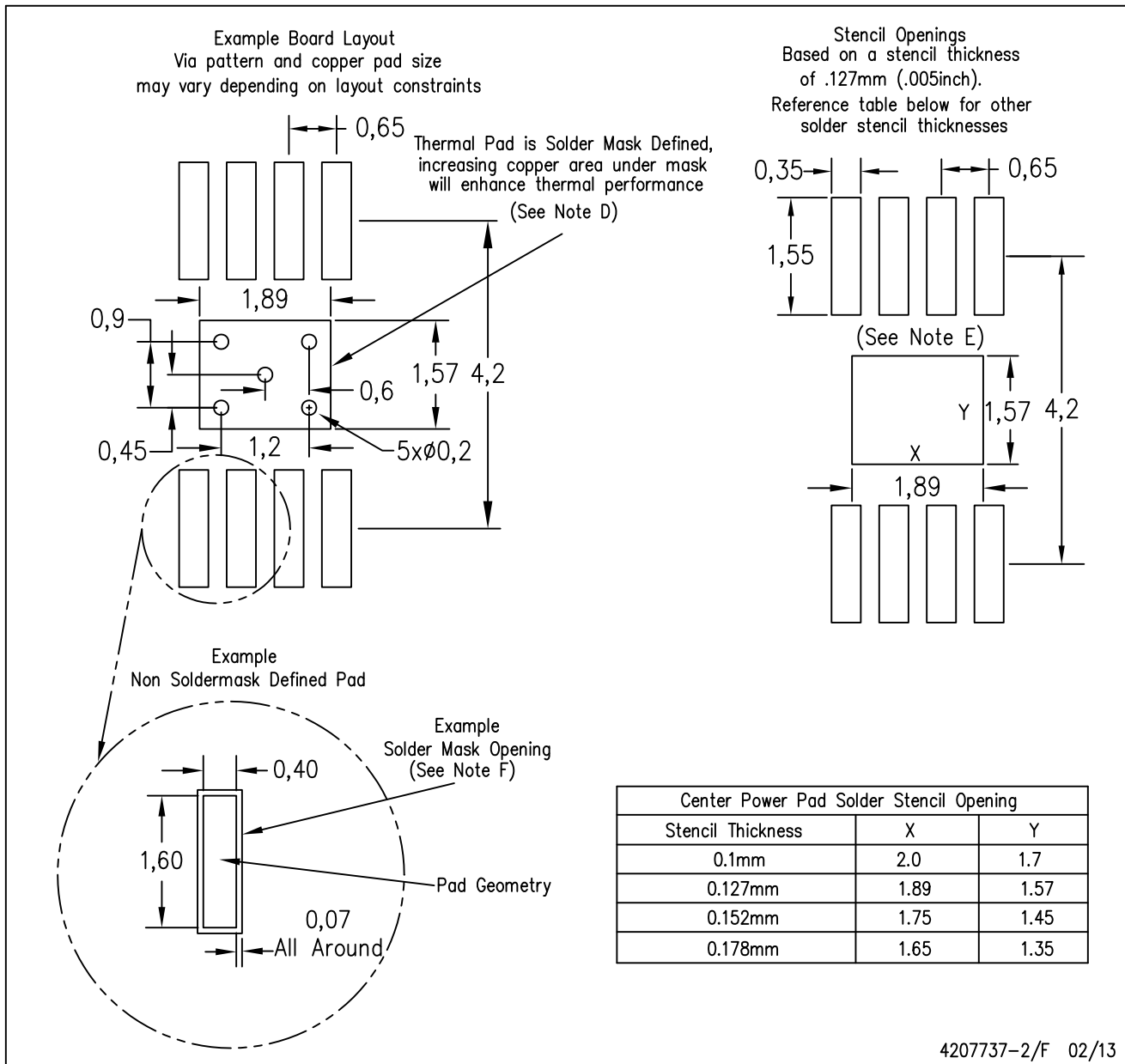

- NOTES:
- A. All linear dimensions are in millimeters.
  - B. This drawing is subject to change without notice.
  - C. Customers should place a note on the circuit board fabrication drawing not to alter the center solder mask defined pad.
  - D. This package is designed to be soldered to a thermal pad on the board. Refer to Technical Brief, PowerPad Thermally Enhanced Package, Texas Instruments Literature No. SLMA002, SLMA004, and also the Product Data Sheets for specific thermal information, via requirements, and recommended board layout. These documents are available at [www.ti.com](http://www.ti.com) <<http://www.ti.com>>.
  - E. Laser cutting apertures with trapezoidal walls and also rounding corners will offer better paste release. Customers should contact their board assembly site for stencil design recommendations. Example stencil design based on a 50% volumetric metal load solder paste. Refer to IPC-7525 for other stencil recommendations.
  - F. Customers should contact their board fabrication site for solder mask tolerances between and around signal pads.

PowerPAD is a trademark of Texas Instruments

## IMPORTANT NOTICE AND DISCLAIMER

TI PROVIDES TECHNICAL AND RELIABILITY DATA (INCLUDING DATASHEETS), DESIGN RESOURCES (INCLUDING REFERENCE DESIGNS), APPLICATION OR OTHER DESIGN ADVICE, WEB TOOLS, SAFETY INFORMATION, AND OTHER RESOURCES "AS IS" AND WITH ALL FAULTS, AND DISCLAIMS ALL WARRANTIES, EXPRESS AND IMPLIED, INCLUDING WITHOUT LIMITATION ANY IMPLIED WARRANTIES OF MERCHANTABILITY, FITNESS FOR A PARTICULAR PURPOSE OR NON-INFRINGEMENT OF THIRD PARTY INTELLECTUAL PROPERTY RIGHTS.

These resources are intended for skilled developers designing with TI products. You are solely responsible for (1) selecting the appropriate TI products for your application, (2) designing, validating and testing your application, and (3) ensuring your application meets applicable standards, and any other safety, security, or other requirements. These resources are subject to change without notice. TI grants you permission to use these resources only for development of an application that uses the TI products described in the resource. Other reproduction and display of these resources is prohibited. No license is granted to any other TI intellectual property right or to any third party intellectual property right. TI disclaims responsibility for, and you will fully indemnify TI and its representatives against, any claims, damages, costs, losses, and liabilities arising out of your use of these resources.

TI's products are provided subject to TI's Terms of Sale ([www.ti.com/legal/termsofsale.html](http://www.ti.com/legal/termsofsale.html)) or other applicable terms available either on [ti.com](http://ti.com) or provided in conjunction with such TI products. TI's provision of these resources does not expand or otherwise alter TI's applicable warranties or warranty disclaimers for TI products.

Mailing Address: Texas Instruments, Post Office Box 655303, Dallas, Texas 75265  
Copyright © 2019, Texas Instruments Incorporated