

THIS DRAWING IS UNPUBLISHED  
RELEASED FOR PUBLICATION  
COPYRIGHT 20 BY - ALL RIGHTS RESERVED.

REVISIONS				
P	LTR	DESCRIPTION	DATE	APVD
C		REVISED PER ECO-13-019168	05DEC2013	DR RB

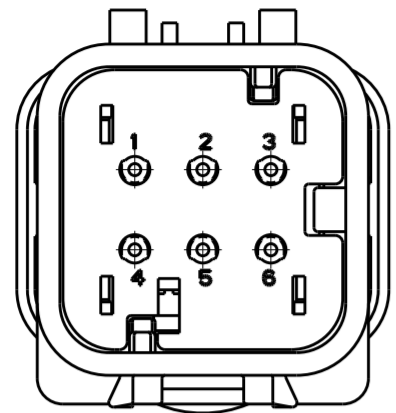

776537-2  
SCALE 2:1

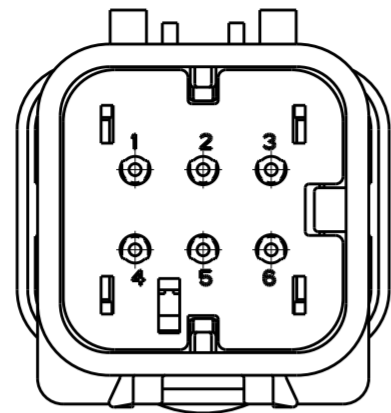

776537-3  
SCALE 2:1

- ① MATERIAL: 15% GLASS FILLED THERMOPLASTIC  
COLOR: BLACK
  - ② MATERIAL: 15% GLASS FILLED THERMOPLASTIC  
COLOR: (SEE TABLE)
  - ③ MATERIAL: SILICONE  
COLOR: LIGHT GRAY
4. RECOMMENDED WIRE DIAMETER RANGE IS 1.30 TO 2.54mm

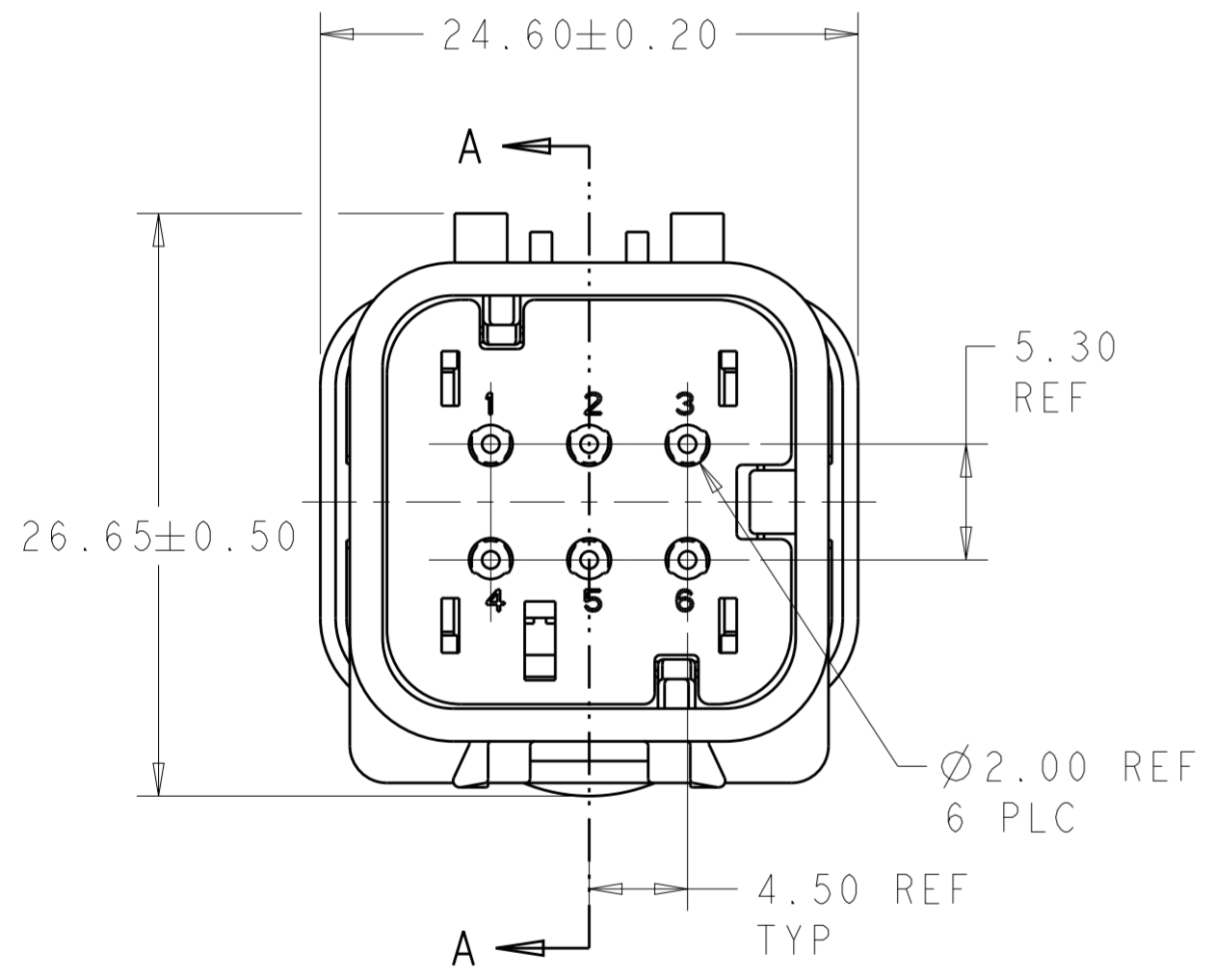

776537-1 SHOWN

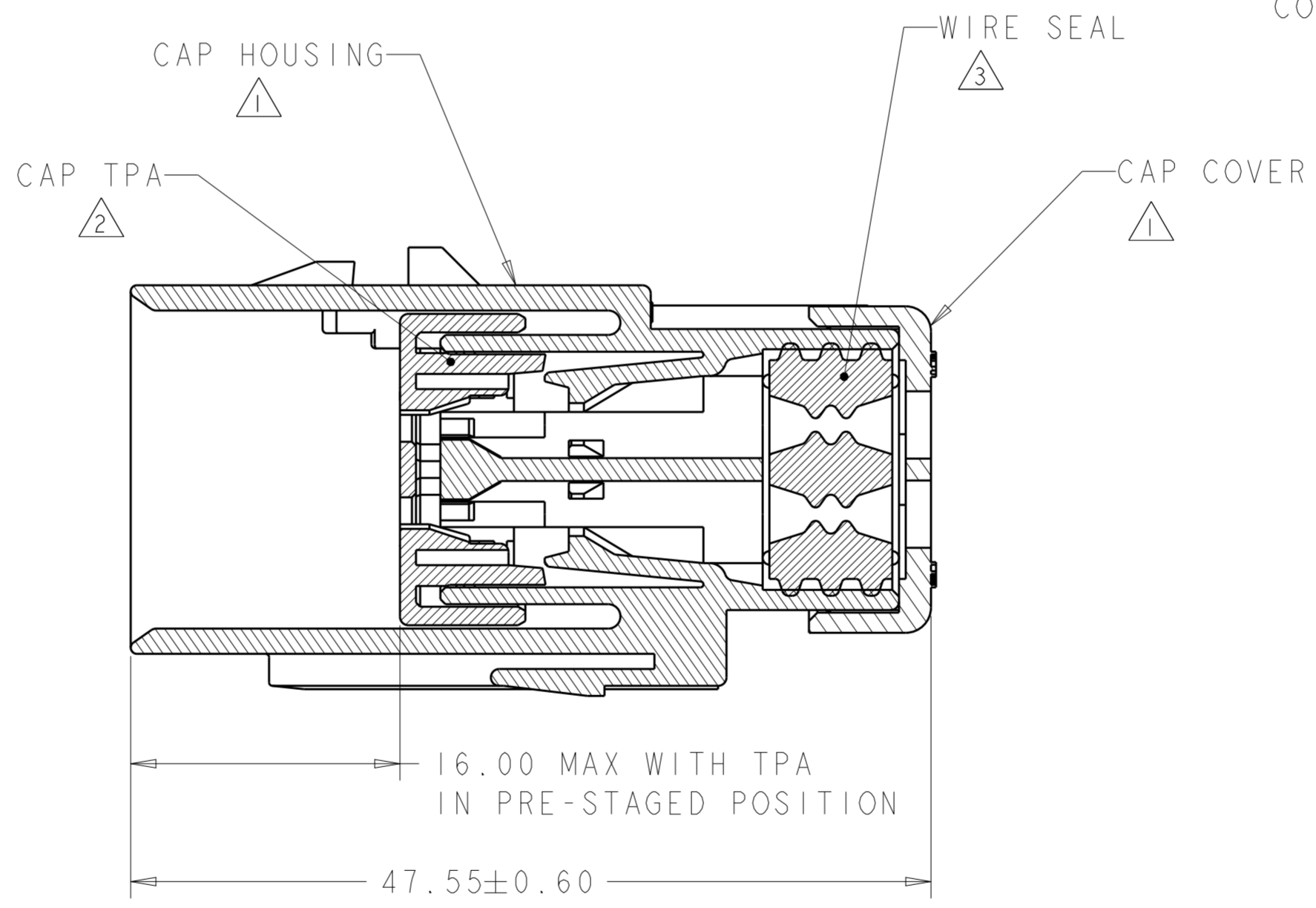

SECTION A-A  
OPEN POSITION

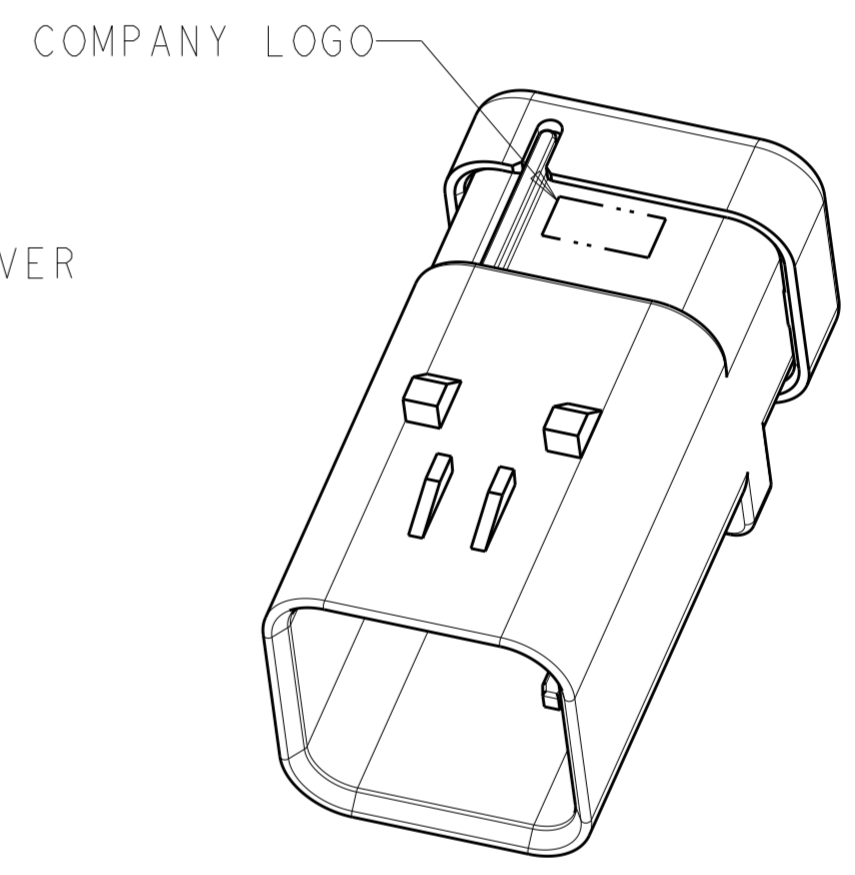

SCALE 2:1

YELLOW	776537-3
GRAY	776537-2
RED	776537-1
TPA COLOR	PART NUMBER

THIS DRAWING IS A CONTROLLED DOCUMENT.		DWN 04SEP2003 W. HOELSCHER	<b>STE</b> TE Connectivity	
DIMENSIONS: mm		CHK 04SEP2003 J. PATTERSON		
TOLERANCES UNLESS OTHERWISE SPECIFIED:		APVD 04SEP2003 D. KLEIN	NAME CAP ASSEMBLY, 6 POSITION, 2 ROW, AMPSEAL 16 CONNECTOR REDUCED DIA WIRE SEAL	
0 PLC ±	1 PLC ±	PRODUCT SPEC 108-2184	SIZE A200779	CAGE CODE C-776537
2 PLC ±	3 PLC ±	APPLICATION SPEC 114-13065	DRAWING NO	RESTRICTED TO
4 PLC ±	ANGLES ±	WEIGHT 15.5	SCALE 2:1	SHEET 1 OF 1
FINISH -	-	Customer Drawing	REV C	

# Mouser Electronics

Authorized Distributor

Click to View Pricing, Inventory, Delivery & Lifecycle Information:

[TE Connectivity:](#)

[776537-2](#)