

Product data sheet

Characteristics

XZCR1512062B1

jumper cable XZ - male straight M12 3-pin - female elbowed M12 3-pin - PUR 1m

Product availability: Non-Stock - Not normally stocked in distribution facility

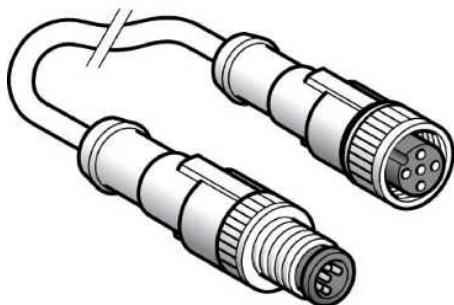

Main

Commercial Status	Commercialised
Accessory / separate part category	Cabling accessories
Accessory / separate part type	Jumper cable
Jumper cable end 1	M12 male 3 pins straight connector with screw-on
Jumper cable end 2	M12 female 3 pins elbowed connector with screw-on

Complementary

Cable composition	3 x 0.5 mm ²
Cable length	3.28 ft (1 m)
Wire insulation material	PUR
Cable outer diameter	0.2 in (5.2 mm)
[Ue] rated operational voltage	36 V DC 30 V AC
[In] rated current	4 A
Insulation resistance	>= 1000 MOhm
Resistance across terminals	<= 5000 mOhm
Product weight	0.14 lb(US) (0.065 kg)

Environment

IP degree of protection	IP67
Ambient air temperature for operation	23...194 °F (-5...90 °C) (flexing) -31...194 °F (-35...90 °C) (static)
Ambient air temperature for storage	-31...212 °F (-35...100 °C)

Ordering and shipping details

Category	22483 - MACHINE CABLES
Discount Schedule	DS3
GTIN	003389110762549
Nbr. of units in pkg.	1
Package weight(Lbs)	0.15
Product availability	Non-Stock - Not normally stocked in distribution facility
Returnability	N
Country of origin	PL

Offer Sustainability

Sustainable offer status	Not Green Premium product
RoHS	Compliant - since 0649 - Schneider Electric declaration of conformity

Contractual warranty

Period	18 months
--------	-----------

Mouser Electronics

Authorized Distributor

Click to View Pricing, Inventory, Delivery & Lifecycle Information:

[Schneider Electric:](#)

[XZCR1512062B1](#)