

NCS2200, NCS2200A, NCS2202, NCS2202A

Comparators, 0.85 V to 6 V, 10 μ A, 1 μ s, Rail-to-Rail, Open Drain and Push-Pull Outputs

The NCS2200 series is an industry first sub-one volt, low power comparator family. These devices consume only 10 μ A of supply current. They are guaranteed to operate at a low voltage of 0.85 V which allows them to be used in systems that require less than 1.0 V and are fully operational up to 6.0 V which makes them convenient for use in both 3.0 V and 5.0 V systems. Additional features include no output phase inversion with overdriven inputs, internal hysteresis, which allows for clean output switching, and rail-to-rail input and output performance. The NCS2200 Series is available in complementary push-pull and open drain outputs and a variety of packages. There are two industry standard pinouts for SOT-23-5 and SC70-5 packages. The NCS2200 is also available in the tiny DFN 2x2.2 package. The NCS2200A and NCS2202A are available in a UDFN 1.2x1.0 package. See package option information in Table 1 on page 2 for more information.

Features

- Operating Voltage of 0.85 V to 6.0 V
- Rail-to-Rail Input/Output Performance
- Low Supply Current of 10 μ A
- No Phase Inversion with Overdriven Input Signals
- Glitchless Transitioning in or out of Tri-State Mode
- Complementary or Open Drain Output Configuration
- Internal Hysteresis
- Propagation Delay of 1.0 μ s for NCS2200
- NCV Prefix for Automotive and Other Applications Requiring Unique Site and Control Change Requirements; AEC-Q100 Qualified and PPAP Capable
- These Devices are Pb-Free and are RoHS Compliant

Typical Applications

- Single Cell NiCd/NiMH Battery Powered Applications
- Automotive

End Products

- Cellphones, Smart Phones
- Alarm and Security Systems
- Personal Digital Assistants



ON Semiconductor®

www.onsemi.com



SOT-23-5 (TSOP-5)
SN SUFFIX
CASE 483



DFN 2x2.2
SQL SUFFIX
CASE 488



SC70-5
SQ SUFFIX
CASE 419A

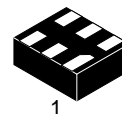

UDFN 1.2x1.0
MU SUFFIX
CASE 517AA

ORDERING INFORMATION

See detailed ordering and shipping information in the package dimensions section on page 13 of this data sheet.

DEVICE MARKING INFORMATION

See general marking information in the device marking section on page 14 of this data sheet.

NCS2200, NCS2200A, NCS2202, NCS2202A

Table 1. COMPARATOR SELECTOR GUIDE

Output Type	Package	Pinout Style	Automotive	Device
Complementary Push-Pull	UDFN, 1.2x1.0	N/A	No	NCS2200AMUT1G
		N/A	Yes	NCV2200AMUTBG*
	SOT-23-5	1	No	NCS2200SN1T1G
			Yes	NCV2200SN1T1G*
		2	No	NCS2200SN2T1G
			Yes	NCV2200SN2T1G*
	SC70-5	2	No	NCS2200SQ2T2G
			Yes	NCV2200SQ2T2G*
DFN, 2x2.2	N/A	No	NCS2200SQLT1G	
Open Drain	SOT-23-5	1	No	NCS2202SN1T1G
		2	No	NCS2202SN2T1G
			Yes	NCV2202SN2T1G*
	SC70-5	1	No	NCS2202SQ1T2G
		2	No	NCS2202SQ2T2G
	UDFN, 1.2 x 1.0	N/A	No	NCS2202AMUTBG

*NCV Prefix for Automotive and Other Applications Requiring Unique Site and Control Change Requirements; AEC-Q100 Qualified and PPA Capable.

PIN CONNECTIONS

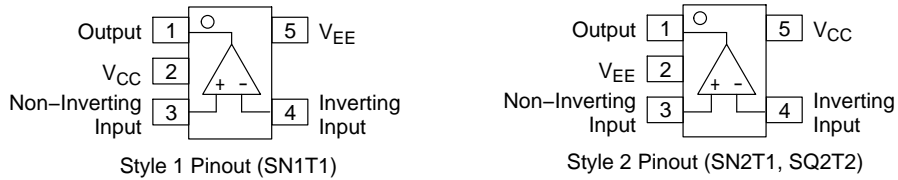

Figure 1. SOT-23-5 (NCS2200, NCS2202), SC70-5 (NCS2200, NCS2202)

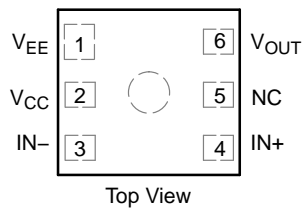

Figure 2. DFN 2x2.2 (NCS2200)

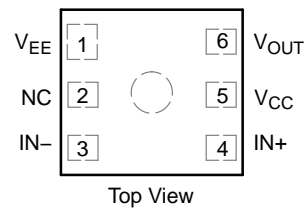

Figure 3. UDFN 1.2x1.0 (NCS2200A/NCS2202A)

NCS2200, NCS2200A, NCS2202, NCS2202A

MAXIMUM RATINGS

Rating	Symbol	Value	Unit
Supply Voltage Range (V_{CC} to V_{EE})	V_S	6.0	V
Non-inverting/Inverting Input to V_{EE}	V_{CM}	-0.2 to ($V_{CC} + 0.2$)	V
Operating Junction Temperature	T_J	150	°C
Operating Ambient Temperature Range NCS2200, NCS2202, NCS2200A, NCS2202A NCV2200, NCV2202, NCV2200A	T_A	-40 to +105 -40 to +125	°C
Storage Temperature Range	T_{stg}	-65 to +150	°C
Output Short Circuit Duration Time (Note 1)	t_s	Indefinite	s
ESD Tolerance (Note 2)	ESD		V
NCS2200			
Human Body Model	HBM	2000	
Machine Model	MM	200	
NCS2202			
Human Body Model	HBM	2000	
Machine Model	MM	200	
NCS2200A			
Human Body Model	HBM	1900	
Machine Model	MM	200	
NCS2202A			
Human Body Model – all pins except output	HBM	1500	
Human Body Model – output pin	HBM	500	
Machine Model	MM	150	
Thermal Resistance, Junction-to-Ambient	$R_{\theta JA}$		°C/W
TSOP-5		238	
DFN (Note 3)		215	
SC70-5		283	
UDFN		350	

Stresses exceeding those listed in the Maximum Ratings table may damage the device. If any of these limits are exceeded, device functionality should not be assumed, damage may occur and reliability may be affected.

1. The maximum package power dissipation limit must not be exceeded.

$$P_D = \frac{T_J(\max) - T_A}{R_{\theta JA}}$$

2. ESD data available upon request.

3. For more information, refer to application note, AND8080/D.

NCS2200, NCS2200A, NCS2202, NCS2202A

NCS2200 ELECTRICAL CHARACTERISTICS (For all values $V_{CC} = 0.85\text{ V}$ to 6.0 V , $V_{EE} = 0\text{ V}$, $T_A = 25^\circ\text{C}$, unless otherwise noted.) (Note 4)

Symbol	Parameter	Conditions	Min	Typ	Max	Unit
V_{HYS}	Input Hysteresis	$T_A = 25^\circ\text{C}$	2.0	8.0	20	mV
V_{IO}	Input Offset Voltage	$V_{CC} = 0.85\text{ V}$ $T_A = 25^\circ\text{C}$ $T_A = T_{Low}$ to T_{High} (Note 5)	-10 -12	0.5 -	+10 +12	mV
		$V_{CC} = 3.0\text{ V}$ $T_A = 25^\circ\text{C}$ $T_A = T_{Low}$ to T_{High}	-6.0 -8.0	0.5 -	+6.0 +8.0	
		$V_{CC} = 6.0\text{ V}$ $T_A = 25^\circ\text{C}$ $T_A = T_{Low}$ to T_{High}	-5.0 -7.0	0.5 -	+5.0 +7.0	
V_{CM}	Common Mode Voltage Range		-	V_{EE} to V_{CC}	-	V
I_{LEAK}	Output Leakage Current	$V_{CC} = 6.0\text{ V}$	-	3.3	-	nA
I_{SC}	Output Short-Circuit Sourcing or Sinking	$V_{out} = \text{GND}$	-	70	-	mA
CMRR	Common Mode Rejection Ratio	$V_{CM} = V_{CC}$	53	65	-	dB
I_{IB}	Input Bias Current		-	1.0	-	pA
PSRR	Power Supply Rejection Ratio	$\Delta V_S = 2.575\text{ V}$	45	55	-	dB
I_{CC}	Supply Current	$V_{CC} = 0.85\text{ V}$ $T_A = 25^\circ\text{C}$ $T_A = T_{Low}$ to T_{High} (Note 5)	-	10 -	15 17	μA
		$V_{CC} = 3.0\text{ V}$ $T_A = 25^\circ\text{C}$ $T_A = T_{Low}$ to T_{High}	-	10 -	15 17	
		$V_{CC} = 6.0\text{ V}$ $T_A = 25^\circ\text{C}$ $T_A = T_{Low}$ to T_{High}	-	10 -	15 17	
V_{OH}	Output Voltage High	$V_{CC} = 0.85\text{ V}$, $I_{source} = 0.5\text{ mA}$ $T_A = 25^\circ\text{C}$ $T_A = T_{Low}$ to T_{High} (Note 5)	$V_{CC} - 0.2$ $V_{CC} - 0.225$	$V_{CC} - 0.10$ -	-	V
		$V_{CC} = 3.0\text{ V}$, $I_{source} = 3.0\text{ mA}$ $T_A = 25^\circ\text{C}$ $T_A = T_{Low}$ to T_{High}	$V_{CC} - 0.2$ $V_{CC} - 0.25$	$V_{CC} - 0.12$ -	-	
		$V_{CC} = 6.0\text{ V}$, $I_{source} = 5.0\text{ mA}$ $T_A = 25^\circ\text{C}$ $T_A = T_{Low}$ to T_{High}	$V_{CC} - 0.2$ $V_{CC} - 0.25$	$V_{CC} - 0.12$ -	-	
V_{OL}	Output Voltage Low	$V_{CC} = 0.85\text{ V}$, $I_{sink} = 0.5\text{ mA}$ $T_A = 25^\circ\text{C}$ $T_A = T_{Low}$ to T_{High} (Note 5)	-	$V_{EE} + 0.10$ -	$V_{EE} + 0.2$ $V_{EE} + 0.225$	V
		$V_{CC} = 3.0\text{ V}$, $I_{sink} = 3.0\text{ mA}$ $T_A = 25^\circ\text{C}$ $T_A = T_{Low}$ to T_{High}	-	$V_{EE} + 0.12$ -	$V_{EE} + 0.2$ $V_{EE} + 0.25$	
		$V_{CC} = 6.0\text{ V}$, $I_{sink} = 5.0\text{ mA}$ $T_A = 25^\circ\text{C}$ $T_A = T_{Low}$ to T_{High}	-	$V_{EE} + 0.12$ -	$V_{EE} + 0.2$ $V_{EE} + 0.25$	
t_{PHL}	Propagation Delay, High-to-Low	20 mV Overdrive, $C_L = 15\text{ pF}$	-	1080	-	ns
t_{PLH}	Propagation Delay, Low-to-High	20 mV Overdrive, $C_L = 15\text{ pF}$	-	900	-	ns
t_{FALL}	Output Fall Time	$V_{CC} = 6.0\text{ V}$, $C_L = 50\text{ pF}$	-	13	-	ns
t_{RISE}	Output Rise Time	$V_{CC} = 6.0\text{ V}$, $C_L = 50\text{ pF}$	-	8.0	-	ns
t_{PU}	Powerup Time		-	35	-	μs

Product parametric performance is indicated in the Electrical Characteristics for the listed test conditions, unless otherwise noted. Product performance may not be indicated by the Electrical Characteristics if operated under different conditions.

4. The limits over the extended temperature range are guaranteed by design only.

5. NCS2200: $T_{Low} = -40^\circ\text{C}$, $T_{High} = +105^\circ\text{C}$; NCV2200: $T_{Low} = -40^\circ\text{C}$, $T_{High} = +125^\circ\text{C}$

NCS2200, NCS2200A, NCS2202, NCS2202A

NCS2202 ELECTRICAL CHARACTERISTICS (For all values $V_{CC} = 0.85\text{ V}$ to 6.0 V , $V_{EE} = 0\text{ V}$, $T_A = 25^\circ\text{C}$, $R_{pullup} = 10\text{ k}\Omega$, unless otherwise noted.) (Note 6)

Symbol	Parameter	Conditions	Min	Typ	Max	Unit
V_{HYS}	Input Hysteresis	$T_A = 25^\circ\text{C}$	2.0	8.0	20	mV
V_{IO}	Input Offset Voltage	$V_{CC} = 0.85\text{ V}$ $T_A = 25^\circ\text{C}$ $T_A = T_{Low}$ to T_{High} (Note 7)	-10 -12	0.5 -	+10 +12	mV
		$V_{CC} = 3.0\text{ V}$ $T_A = 25^\circ\text{C}$ $T_A = T_{Low}$ to T_{High}	-6.0 -8.0	0.5 -	+6.0 +8.0	
		$V_{CC} = 6.0\text{ V}$ $T_A = 25^\circ\text{C}$ $T_A = T_{Low}$ to T_{High}	-5.0 -7.0	0.5 -	+5.0 +7.0	
V_{CM}	Common Mode Voltage Range		-	V_{EE} to V_{CC}	-	V
I_{LEAK}	Output Leakage Current	$V_{CC} = 6.0\text{ V}$	-	3.3	-	nA
I_{SC}	Output Short-Circuit Sourcing or Sinking	$V_{out} = \text{GND}$	-	70	-	mA
CMRR	Common Mode Rejection Ratio	$V_{CM} = V_{CC}$	53	65	-	dB
I_{IB}	Input Bias Current		-	1.0	-	pA
PSRR	Power Supply Rejection Ratio	$\Delta V_S = 2.575\text{ V}$	45	55	-	dB
I_{CC}	Supply Current	$V_{CC} = 0.85\text{ V}$ $T_A = 25^\circ\text{C}$ $T_A = T_{Low}$ to T_{High} (Note 7)	-	10 -	15 17	μA
		$V_{CC} = 3.0\text{ V}$ $T_A = 25^\circ\text{C}$ $T_A = T_{Low}$ to T_{High}	-	10 -	15 17	
		$V_{CC} = 6.0\text{ V}$ $T_A = 25^\circ\text{C}$ $T_A = T_{Low}$ to T_{High}	-	10 -	15 17	
V_{OL}	Output Voltage Low	$V_{CC} = 0.85\text{ V}$, $I_{sink} = 0.5\text{ mA}$ $T_A = 25^\circ\text{C}$ $T_A = T_{Low}$ to T_{High} (Note 7)	-	$V_{EE} + 0.10$ -	$V_{EE} + 0.2$ $V_{EE} + 0.225$	V
		$V_{CC} = 3.0\text{ V}$, $I_{sink} = 3.0\text{ mA}$ $T_A = 25^\circ\text{C}$ $T_A = T_{Low}$ to T_{High}	-	$V_{EE} + 0.12$ -	$V_{EE} + 0.2$ $V_{EE} + 0.25$	
		$V_{CC} = 6.0\text{ V}$, $I_{sink} = 5.0\text{ mA}$ $T_A = 25^\circ\text{C}$ $T_A = T_{Low}$ to T_{High}	-	$V_{EE} + 0.12$ -	$V_{EE} + 0.2$ $V_{EE} + 0.25$	
t_{PHL}	Propagation Delay, High-to-Low	20 mV Overdrive, $C_L = 15\text{ pF}$	-	1000	-	ns
t_{PLH}	Propagation Delay, Low-to-High	20 mV Overdrive, $C_L = 15\text{ pF}$	-	800	-	ns
t_{FALL}	Output Fall Time	$V_{CC} = 6.0\text{ V}$, $C_L = 50\text{ pF}$	-	6.0	-	ns
t_{RISE}	Output Rise Time	$V_{CC} = 6.0\text{ V}$, $C_L = 50\text{ pF}$	-	260	-	ns
t_{PU}	Powerup Time		-	35	-	μs

Product parametric performance is indicated in the Electrical Characteristics for the listed test conditions, unless otherwise noted. Product performance may not be indicated by the Electrical Characteristics if operated under different conditions.

6. The limits over the extended temperature range are guaranteed by design only.

7. NCS2202: $T_{Low} = -40^\circ\text{C}$, $T_{High} = +105^\circ\text{C}$; NCV2202: $T_{Low} = -40^\circ\text{C}$, $T_{High} = +125^\circ\text{C}$

NCS2200, NCS2200A, NCS2202, NCS2202A

NCS2200A ELECTRICAL CHARACTERISTICS (For all values $V_{CC} = 0.85\text{ V}$ to 6.0 V , $V_{EE} = 0\text{ V}$, $T_A = 25^\circ\text{C}$, unless otherwise noted.) (Note 8)

Symbol	Parameter	Conditions	Min	Typ	Max	Unit
V_{HYS}	Input Hysteresis	$T_A = 25^\circ\text{C}$	2.0	4.5	20	mV
V_{IO}	Input Offset Voltage	$V_{CC} = 0.85\text{ V}$ $T_A = 25^\circ\text{C}$ $T_A = T_{LOW}$ to T_{HIGH}	-10 -12	0.5 -	+10 +12	mV
		$V_{CC} = 3.0\text{ V}$ $T_A = 25^\circ\text{C}$ $T_A = T_{LOW}$ to T_{HIGH}	-6.0 -8.0	0.5 -	+6.0 +8.0	
		$V_{CC} = 6.0\text{ V}$ $T_A = 25^\circ\text{C}$ $T_A = T_{LOW}$ to T_{HIGH}	-5.0 -7.0	0.5 -	+5.0 +7.0	
V_{CM}	Common Mode Voltage Range		-	V_{EE} to V_{CC}	-	V
I_{SC}	Output Short-Circuit Sourcing or Sinking	$V_{out} = \text{GND}$	-	60	-	mA
CMRR	Common Mode Rejection Ratio	$V_{CM} = V_{CC}$	53	70	-	dB
I_{IB}	Input Bias Current		-	1.0	-	pA
PSRR	Power Supply Rejection Ratio	$\Delta V_S = 2.575\text{ V}$	45	80	-	dB
I_{CC}	Supply Current	$V_{CC} = 0.85\text{ V}$ $T_A = 25^\circ\text{C}$ $T_A = T_{LOW}$ to T_{HIGH}	-	7.5 -	15 17	μA
		$V_{CC} = 3.0\text{ V}$ $T_A = 25^\circ\text{C}$ $T_A = T_{LOW}$ to T_{HIGH}	-	8.0 -	15 17	
		$V_{CC} = 6.0\text{ V}$ $T_A = 25^\circ\text{C}$ $T_A = T_{LOW}$ to T_{HIGH}	-	9.0 -	15 17	
V_{OH}	Output Voltage High	$V_{CC} = 0.85\text{ V}$, $I_{source} = 0.5\text{ mA}$ $T_A = 25^\circ\text{C}$ $T_A = T_{LOW}$ to T_{HIGH}	$V_{CC} - 0.25$ $V_{CC} - 0.275$	$V_{CC} - 0.10$ -	-	V
		$V_{CC} = 3.0\text{ V}$, $I_{source} = 3.0\text{ mA}$ $T_A = 25^\circ\text{C}$ $T_A = T_{LOW}$ to T_{HIGH}	$V_{CC} - 0.3$ $V_{CC} - 0.35$	$V_{CC} - 0.12$ -	-	
		$V_{CC} = 6.0\text{ V}$, $I_{source} = 5.0\text{ mA}$ $T_A = 25^\circ\text{C}$ $T_A = T_{LOW}$ to T_{HIGH}	$V_{CC} - 0.3$ $V_{CC} - 0.35$	$V_{CC} - 0.12$ -	-	
V_{OL}	Output Voltage Low	$V_{CC} = 0.85\text{ V}$, $I_{sink} = 0.5\text{ mA}$ $T_A = 25^\circ\text{C}$ $T_A = T_{LOW}$ to T_{HIGH}	-	$V_{EE} + 0.10$ -	$V_{EE} + 0.25$ $V_{EE} + 0.275$	V
		$V_{CC} = 3.0\text{ V}$, $I_{sink} = 3.0\text{ mA}$ $T_A = 25^\circ\text{C}$ $T_A = T_{LOW}$ to T_{HIGH}	-	$V_{EE} + 0.12$ -	$V_{EE} + 0.3$ $V_{EE} + 0.35$	
		$V_{CC} = 6.0\text{ V}$, $I_{sink} = 5.0\text{ mA}$ $T_A = 25^\circ\text{C}$ $T_A = T_{LOW}$ to T_{HIGH}	-	$V_{EE} + 0.12$ -	$V_{EE} + 0.3$ $V_{EE} + 0.35$	
t_{PHL}	Propagation Delay, High-to-Low	20 mV Overdrive, $C_L = 15\text{ pF}$, $V_{CC} = 2.85\text{ V}$	-	625	-	ns
t_{PLH}	Propagation Delay, Low-to-High		-	750	-	ns
t_{FALL}	Output Fall Time	$V_{CC} = 6.0\text{ V}$, $C_L = 50\text{ pF}$ (Note 9)	-	22	-	ns
t_{RISE}	Output Rise Time	$V_{CC} = 6.0\text{ V}$, $C_L = 50\text{ pF}$ (Note 9)	-	20	-	ns

Product parametric performance is indicated in the Electrical Characteristics for the listed test conditions, unless otherwise noted. Product performance may not be indicated by the Electrical Characteristics if operated under different conditions.

8. The limits over the extended temperature range are guaranteed by design only.

9. Input signal: 1 kHz, squarewave signal with 10 ns edge rate.

10. NCS2200A: $T_{LOW} = -40^\circ\text{C}$, $T_{HIGH} = +105^\circ\text{C}$; NCV2200A: $T_{LOW} = -40^\circ\text{C}$, $T_{HIGH} = +125^\circ\text{C}$.

NCS2200, NCS2200A, NCS2202, NCS2202A

NCS2202A ELECTRICAL CHARACTERISTICS (For all values $V_{CC} = 0.85\text{ V}$ to 6.0 V , $V_{EE} = 0\text{ V}$, $T_A = 25^\circ\text{C}$, $R_{pullup} = 10\text{ k}\Omega$, unless otherwise noted.) (Note 11)

Symbol	Parameter	Conditions	Min	Typ	Max	Unit
V_{HYS}	Input Hysteresis	$T_A = 25^\circ\text{C}$	2.0	4.5	20	mV
V_{IO}	Input Offset Voltage	$V_{CC} = 0.85\text{ V}$ $T_A = 25^\circ\text{C}$ $T_A = -40^\circ\text{C}$ to 105°C	-10 -12	0.3 -	+10 +12	mV
		$V_{CC} = 3.0\text{ V}$ $T_A = 25^\circ\text{C}$ $T_A = -40^\circ\text{C}$ to 105°C	-6.0 -8.0	0.4 -	+6.0 +8.0	
		$V_{CC} = 6.0\text{ V}$ $T_A = 25^\circ\text{C}$ $T_A = -40^\circ\text{C}$ to 105°C	-5.0 -7.0	0.4 -	+5.0 +7.0	
V_{CM}	Common Mode Voltage Range		-	V_{EE} to V_{CC}	-	V
I_{SC}	Output Short-Circuit Sourcing or Sinking	$V_{out} = \text{GND}$	-	60	-	mA
CMRR	Common Mode Rejection Ratio	$V_{CM} = V_{CC}$	53	80	-	dB
I_{IB}	Input Bias Current		-	1.0	-	pA
PSRR	Power Supply Rejection Ratio	$\Delta V_S = 2.575\text{ V}$	45	80	-	dB
I_{CC}	Supply Current	$V_{CC} = 0.85\text{ V}$ $T_A = 25^\circ\text{C}$ $T_A = -40^\circ\text{C}$ to 105°C	-	7.5 -	15 17	μA
		$V_{CC} = 3.0\text{ V}$ $T_A = 25^\circ\text{C}$ $T_A = -40^\circ\text{C}$ to 105°C	-	8.0 -	15 17	
		$V_{CC} = 6.0\text{ V}$ $T_A = 25^\circ\text{C}$ $T_A = -40^\circ\text{C}$ to 105°C	-	9.0 -	15 17	
V_{OL}	Output Voltage Low	$V_{CC} = 0.85\text{ V}$, $I_{sink} = 0.5\text{ mA}$ $T_A = 25^\circ\text{C}$ $T_A = -40^\circ\text{C}$ to 105°C	-	$V_{EE} + 0.14$ -	$V_{EE} + 0.25$ $V_{EE} + 0.275$	V
		$V_{CC} = 3.0\text{ V}$, $I_{sink} = 3.0\text{ mA}$ $T_A = 25^\circ\text{C}$ $T_A = -40^\circ\text{C}$ to 105°C	-	$V_{EE} + 0.18$ -	$V_{EE} + 0.3$ $V_{EE} + 0.35$	
		$V_{CC} = 6.0\text{ V}$, $I_{sink} = 5.0\text{ mA}$ $T_A = 25^\circ\text{C}$ $T_A = -40^\circ\text{C}$ to 105°C	-	$V_{EE} + 0.20$ -	$V_{EE} + 0.3$ $V_{EE} + 0.35$	
t_{PHL}	Propagation Delay – High to Low	20 mV Overdrive, $C_L = 15\text{ pF}$, $V_{CC} = 2.85\text{ V}$	-	580	-	ns
		50 mV Overdrive, $C_L = 15\text{ pF}$, $V_{CC} = 2.85\text{ V}$	-	350	-	
		100 mV Overdrive, $C_L = 15\text{ pF}$, $V_{CC} = 2.85\text{ V}$	-	220	-	
t_{PLH}	Propagation Delay – Low to High	20 mV Overdrive, $C_L = 15\text{ pF}$, $V_{CC} = 2.85\text{ V}$	-	550	-	ns
		50 mV Overdrive, $C_L = 15\text{ pF}$, $V_{CC} = 2.85\text{ V}$	-	400	-	
		100 mV Overdrive, $C_L = 15\text{ pF}$, $V_{CC} = 2.85\text{ V}$	-	340	-	
t_{FALL}	Output Fall Time	$V_{CC} = 6.0\text{ V}$, $C_L = 50\text{ pF}$ (Note 12)	-	5.0	-	ns
t_{RISE}	Output Rise Time	$V_{CC} = 6.0\text{ V}$, $C_L = 50\text{ pF}$ (Note 12)	-	235	-	ns

Product parametric performance is indicated in the Electrical Characteristics for the listed test conditions, unless otherwise noted. Product performance may not be indicated by the Electrical Characteristics if operated under different conditions.

11. The limits over the extended temperature range are guaranteed by design only.

12. Input signal: 1 kHz, squarewave signal with 10 ns edge rate.

NCS2200, NCS2200A, NCS2202, NCS2202A



Figure 1. NCS2200 Series Supply Current versus Temperature



Figure 2. NCS2200 Series Supply Current versus Output Transition Frequency

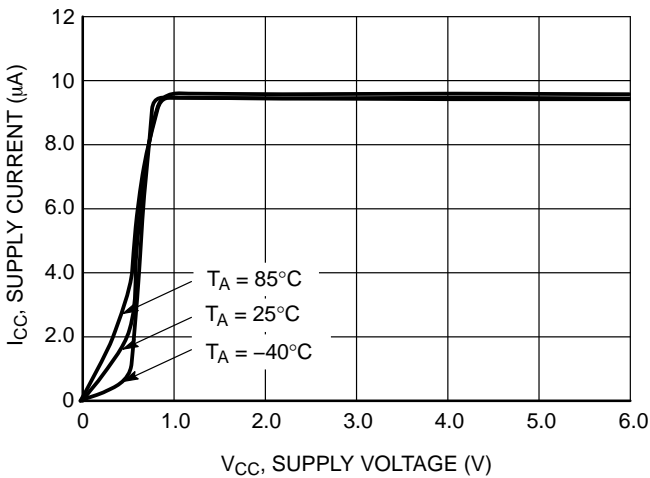

Figure 3. NCS2200 Series Supply Current versus Supply Voltage

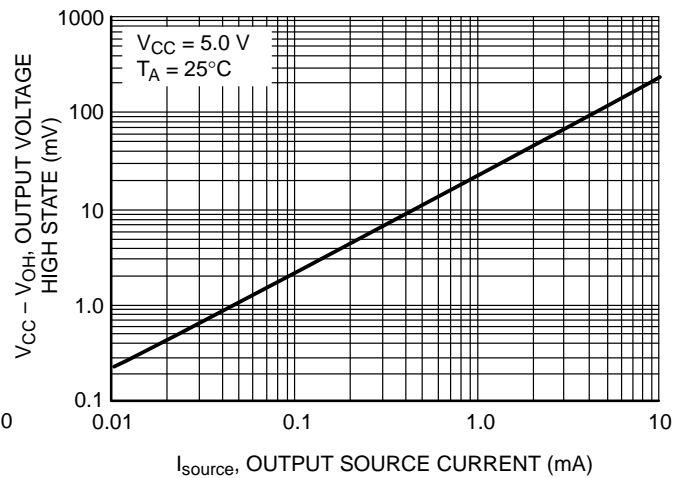

Figure 4. NCS2200 Output Voltage High State versus Output Source Current

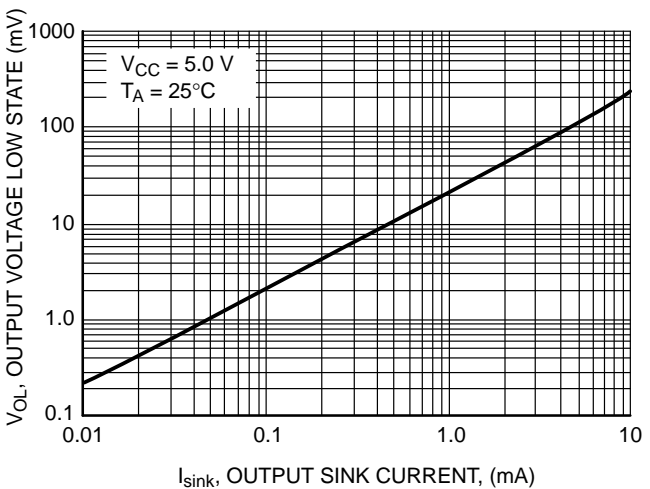

Figure 5. NCS2200 Series Output Voltage Low State versus Output Sink Current



Figure 6. NCS2200 Series Output Voltage Low State versus Temperature

NCS2200, NCS2200A, NCS2202, NCS2202A



Figure 7. NCS2200 Series Output Voltage High State versus Temperature

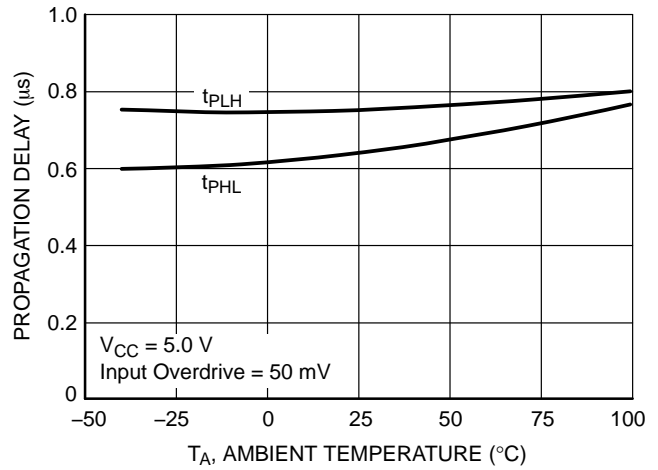

Figure 8. NCS2200 Series Propagation Delay versus Temperature

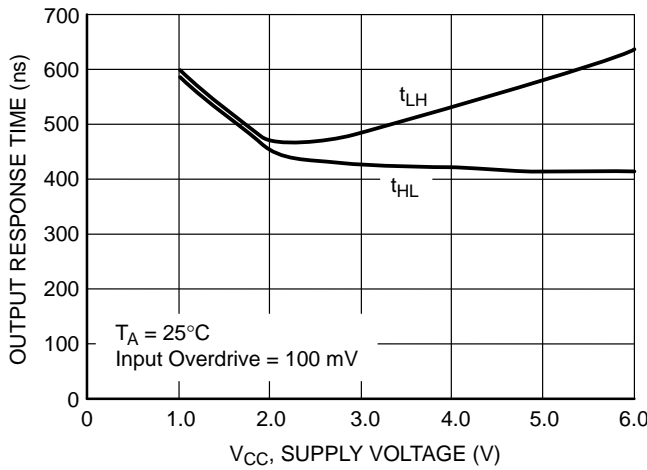

Figure 9. NCS2200 Series Output Response Time versus Supply Voltage

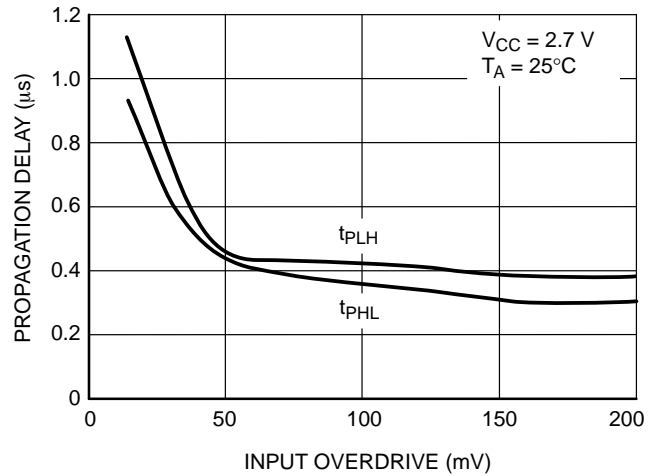

Figure 10. NCS2200 Series Propagation Delay versus Input Overdrive

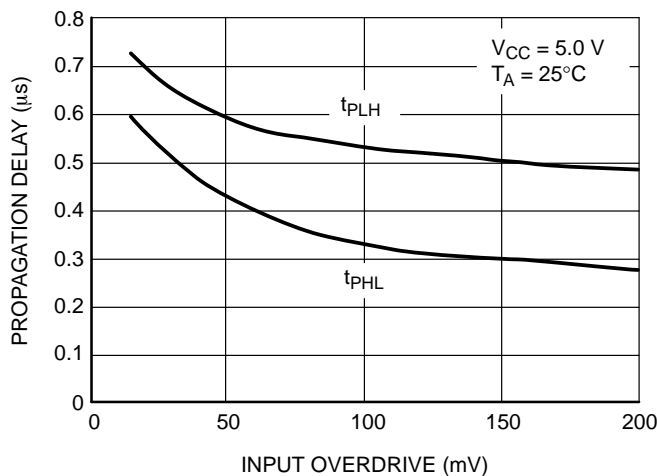

Figure 11. NCS2200 Series Propagation Delay versus Input Overdrive

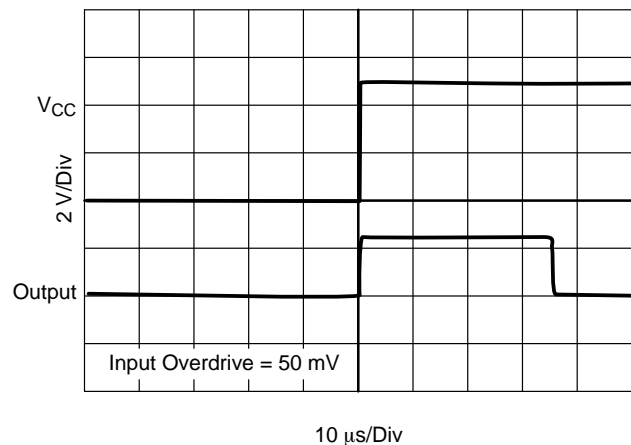

Figure 12. NCS2200 Series Powerup Delay

NCS2200, NCS2200A, NCS2202, NCS2202A

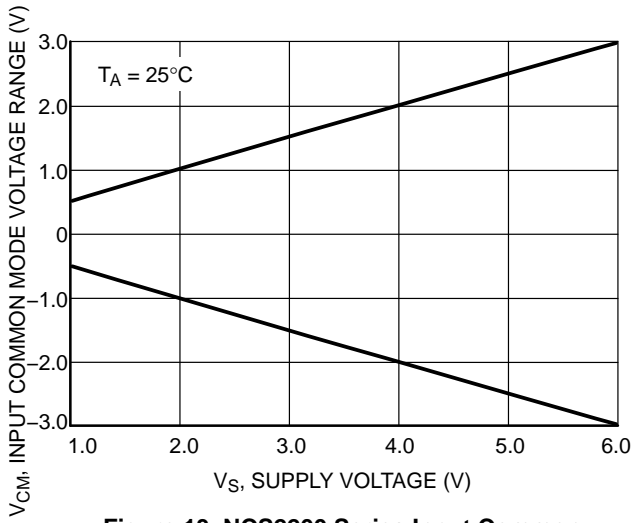

Figure 13. NCS2200 Series Input Common Mode Voltage Range versus Supply Voltage



Figure 14. NCS2202 Output Leakage Current versus Output Voltage



Figure 15. Input Bias Current versus Temperature

NCS2200, NCS2200A, NCS2202, NCS2202A

OPERATING DESCRIPTION

The NCS2200 series is an industry first sub-one volt, low power comparator family. This series is designed for rail-to-rail input and output performance. These devices consume only 10 μ A of supply current while achieving a typical propagation delay of 1.1 μ s at a 20 mV input overdrive. Figures 10 and 11 show propagation delay with various input overdrives. This comparator family is guaranteed to operate at a low voltage of 0.85 V up to 6.0 V. This is accomplished by the use of a modified analog CMOS process that implements depletion MOSFET devices. The common-mode input voltage range extends 0.1 V beyond the upper and lower rail without phase inversion or other adverse effects. This series is available in the SOT-23-5

package. Additionally, the NCS2200 device is available in the tiny DFN 2x2.2 package and the SC70-5 package. NCS2200A is available in UDFN package.

Output Stage

The NCS2200 has a complementary P and N Channel output stage that has capability of driving a rail-to-rail output swing with a load ranging up to 5.0 mA. It is designed such that shoot-through current is minimized while switching. This feature eliminates the need for bypass capacitors under most circumstances.

The NCS2202 has an open drain N-channel output stage that can be pulled up to 6.0 V (max) with an external resistor. This facilitates mixed voltage system applications.



Figure 16. NCS2200/NCS2200A Complementary Push-Pull Output



Figure 17. NCS2202/NCS2202A Open Drain Output Configuration

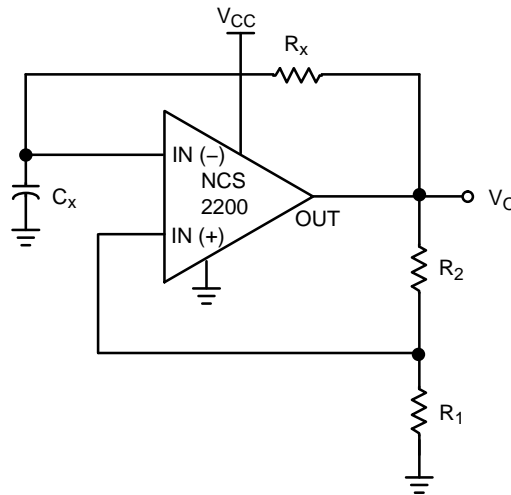

The oscillation frequency can be programmed as follows:

$$f = \frac{1}{T} = \frac{1}{2.2 R_x C_x}$$

Figure 18. Schmitt Trigger Oscillator



The resistor divider R_1 and R_2 can be used to set the magnitude of the input pulse. The pulse width is set by adjusting C_1 and R_3 .

Figure 19. One-Shot Multivibrator



This circuit converts 5 V logic to 3 V logic. Using the NCS2202/A allows for full 5 V logic swing without creating overvoltage on the 3 V logic input.

Figure 20. Logic Level Translator



Figure 21. Zero-Crossing Detector

NCS2200, NCS2200A, NCS2202, NCS2202A

ORDERING INFORMATION

Device	Pinout Style	Output Type	Package	Shipping†
NCS2200AMUT1G	N/A	Complementary Push-Pull	UDFN (Pb-Free)	3000 / Tape & Reel
NCV2200AMUTBG*	N/A	Complementary Push-Pull	UDFN (Pb-Free)	3000 / Tape & Reel
NCS2200SN1T1G	1	Complementary Push-Pull	SOT-23-5 (TSOP-5) (Pb-Free)	3000 / Tape & Reel
NCV2200SN1T1G*	1	Complementary Push-Pull	SOT-23-5 (TSOP-5) (Pb-Free)	3000 / Tape & Reel
NCS2200SN2T1G	2	Complementary Push-Pull	SOT-23-5 (TSOP-5) (Pb-Free)	3000 / Tape & Reel
NCV2200SN2T1G*	2	Complementary Push-Pull	SOT-23-5 (TSOP-5) (Pb-Free)	3000 / Tape & Reel
NCS2200SQ2T2G	2	Complementary Push-Pull	SC70-5 (Pb-Free)	3000 / Tape & Reel
NCV2200SQ2T2G*	2	Complementary Push-Pull	SC70-5 (Pb-Free)	3000 / Tape & Reel
NCS2200SQT1G	N/A	Complementary Push-Pull	DFN, 2x2.2 (Pb-Free)	3000 / Tape & Reel
NCS2202SN1T1G	1	Open Drain	SOT-23-5 (TSOP-5) (Pb-Free)	3000 / Tape & Reel
NCS2202SN2T1G	2	Open Drain	SOT-23-5 (TSOP-5) (Pb-Free)	3000 / Tape & Reel
NCV2202SN2T1G*	2	Open Drain	SOT-23-5 (TSOP-5) (Pb-Free)	3000 / Tape & Reel
NCS2202SQ1T2G	1	Open Drain	SC70-5 (Pb-Free)	3000 / Tape & Reel
NCS2202SQ2T2G	2	Open Drain	SC70-5 (Pb-Free)	3000 / Tape & Reel
NCS2202AMUTBG	N/A	Open Drain	UDFN (Pb-Free)	3000 / Tape & Reel

This device contains 93 active transistors.

†For information on tape and reel specifications, including part orientation and tape sizes, please refer to our Tape and Reel Packaging Specifications Brochure, BRD8011/D.

*NCV Prefix for Automotive and Other Applications Requiring Unique Site and Control Change Requirements; AEC-Q100 Qualified and PPAP Capable.

NCS2200, NCS2200A, NCS2202, NCS2202A

MARKING DIAGRAMS

**SOT-23-5
(TSOP-5)
SN SUFFIX
CASE 483**



- x = I for NCS2200SN1T1
- J for NCS2200SN2T1
- M for NCS2202SN1T1
- N for NCS2202SN2T1
- A = Assembly Location
- Y = Year
- W = Work Week
- = Pb-Free Package

(Note: Microdot may be in either location)

**SC70-5
SQ SUFFIX
CASE 419A**

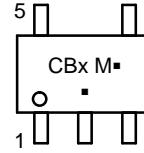

- CBx = Specific Device Code
- x = A for NCS2200SQ2T2
- D for NCS2202SQ1T2G
- E for NCS2202SQ2T2G
- M = Date Code*
- = Pb-Free Package

(Note: Microdot may be in either location)
*Date Code orientation, position, and underbar may vary depending upon manufacturing location.

**DFN6 2x2.2
SQL SUFFIX
CASE 488**

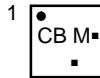

- CB = Specific Device Code
- M = Date Code*
- = Pb-Free Package

(Note: Microdot may be in either location)

*Date Code overbar and underbar may vary depending upon manufacturing location.

**UDFN6 1.2x1.0
MU SUFFIX
CASE 517AA**

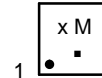

(Top View)

- x = S for Specific Device Code
- V for NCS2202A (V with 180° Rotation)
- M = Date Code
- = Pb-Free Package

PACKAGE DIMENSIONS

SOT-23-5 / TSOP-5 / SC59-5
 SN SUFFIX
 CASE 483-02
 ISSUE M

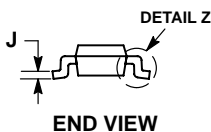
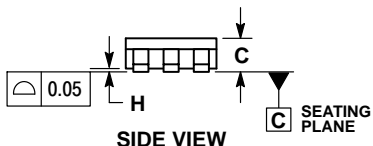
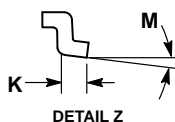
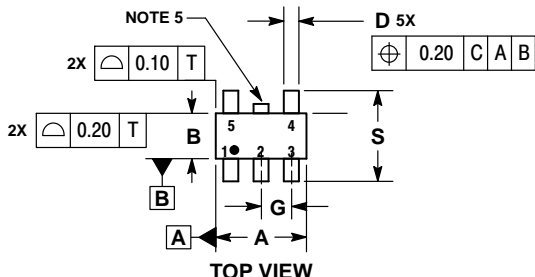

NOTES:

1. DIMENSIONING AND TOLERANCING PER ASME Y14.5M, 1994.
2. CONTROLLING DIMENSION: MILLIMETERS.
3. MAXIMUM LEAD THICKNESS INCLUDES LEAD FINISH THICKNESS. MINIMUM LEAD THICKNESS IS THE MINIMUM THICKNESS OF BASE MATERIAL.
4. DIMENSIONS A AND B DO NOT INCLUDE MOLD FLASH, PROTRUSIONS, OR GATE BURRS. MOLD FLASH, PROTRUSIONS, OR GATE BURRS SHALL NOT EXCEED 0.15 PER SIDE. DIMENSION A.
5. OPTIONAL CONSTRUCTION: AN ADDITIONAL TRIMMED LEAD IS ALLOWED IN THIS LOCATION. TRIMMED LEAD NOT TO EXTEND MORE THAN 0.2 FROM BODY.

DIM	MILLIMETERS	
	MIN	MAX
A	2.85	3.15
B	1.35	1.65
C	0.90	1.10
D	0.25	0.50
G	0.95 BSC	
H	0.01	0.10
J	0.10	0.26
K	0.20	0.60
M	0°	10°
S	2.50	3.00

SOLDERING FOOTPRINT*

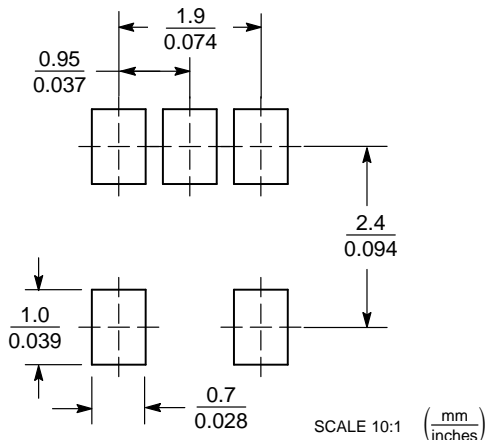

*For additional information on our Pb-Free strategy and soldering details, please download the ON Semiconductor Soldering and Mounting Techniques Reference Manual, SOLDERRM/D.

NCS2200, NCS2200A, NCS2202, NCS2202A

PACKAGE DIMENSIONS

SC-88A (SC-70-5/SOT-353)
 SQ SUFFIX
 CASE 419A-02
 ISSUE L

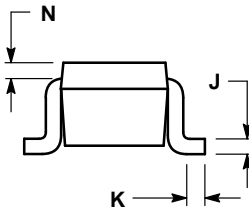
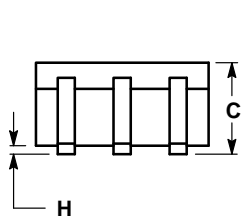
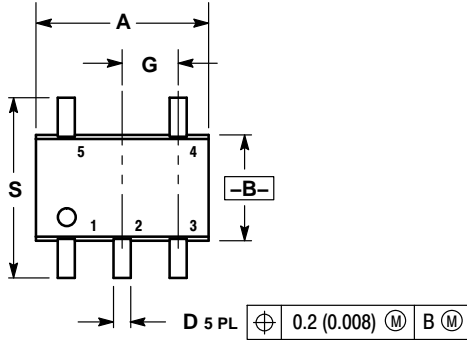

NOTES:

1. DIMENSIONING AND TOLERANCING PER ANSI Y14.5M, 1982.
2. CONTROLLING DIMENSION: INCH.
3. 419A-01 OBSOLETE. NEW STANDARD 419A-02.
4. DIMENSIONS A AND B DO NOT INCLUDE MOLD FLASH, PROTRUSIONS, OR GATE BURRS.

DIM	INCHES		MILLIMETERS	
	MIN	MAX	MIN	MAX
A	0.071	0.087	1.80	2.20
B	0.045	0.053	1.15	1.35
C	0.031	0.043	0.80	1.10
D	0.004	0.012	0.10	0.30
G	0.026 BSC		0.65 BSC	
H	---	0.004	---	0.10
J	0.004	0.010	0.10	0.25
K	0.004	0.012	0.10	0.30
N	0.008 REF		0.20 REF	
S	0.079	0.087	2.00	2.20

SOLDERING FOOTPRINT*

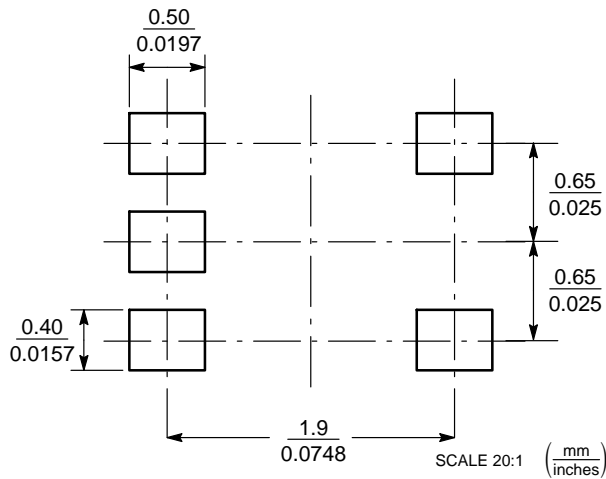

*For additional information on our Pb-Free strategy and soldering details, please download the ON Semiconductor Soldering and Mounting Techniques Reference Manual, SOLDERRM/D.

NCS2200, NCS2200A, NCS2202, NCS2202A

PACKAGE DIMENSIONS

UDFN6, 1.2x1.0, 0.4P
CASE 517AA
ISSUE D

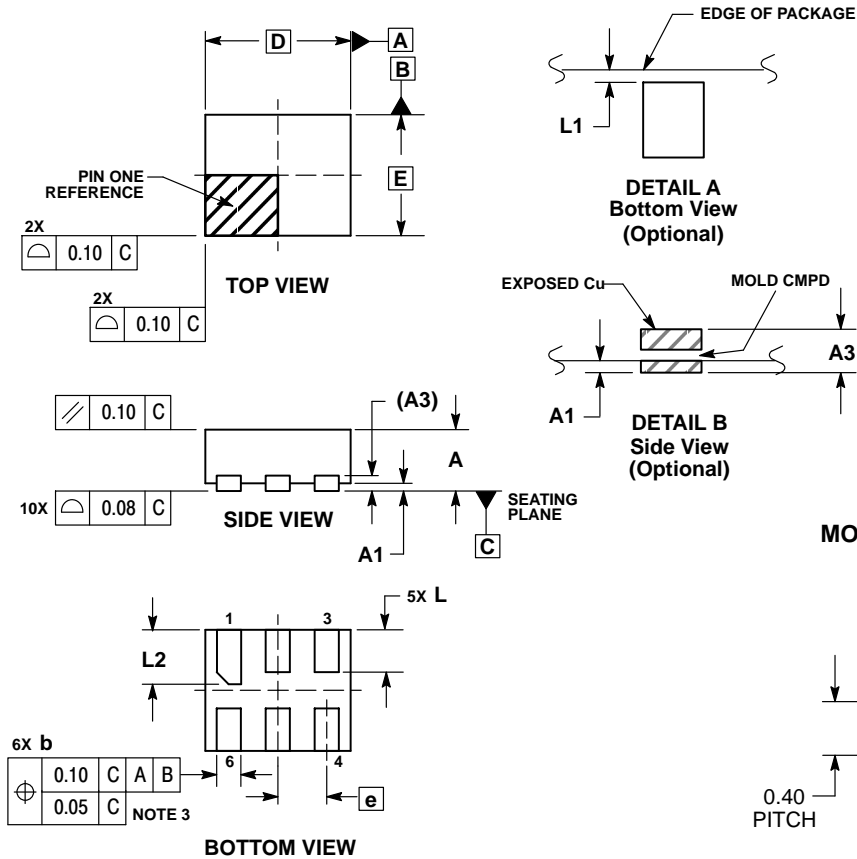

- NOTES:
1. DIMENSIONING AND TOLERANCING PER ASME Y14.5M, 1994.
 2. CONTROLLING DIMENSION: MILLIMETERS.
 3. DIMENSION b APPLIES TO PLATED TERMINAL AND IS MEASURED BETWEEN 0.25 AND 0.30 mm FROM TERMINAL.
 4. COPLANARITY APPLIES TO THE EXPOSED PAD AS WELL AS THE TERMINALS.

MILLIMETERS		
DIM	MIN	MAX
A	0.45	0.55
A1	0.00	0.05
A3	0.127 REF	
b	0.15	0.25
D	1.20 BSC	
E	1.00 BSC	
e	0.40 BSC	
L	0.30	0.40
L1	0.00	0.15
L2	0.40	0.50

MOUNTING FOOTPRINT*

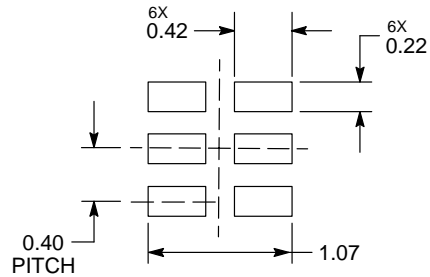

DIMENSIONS: MILLIMETERS

*For additional information on our Pb-Free strategy and soldering details, please download the ON Semiconductor Soldering and Mounting Techniques Reference Manual, SOLDERRM/D.

ON Semiconductor and are trademarks of Semiconductor Components Industries, LLC dba ON Semiconductor or its subsidiaries in the United States and/or other countries. ON Semiconductor owns the rights to a number of patents, trademarks, copyrights, trade secrets, and other intellectual property. A listing of ON Semiconductor's product/patent coverage may be accessed at www.onsemi.com/site/pdf/Patent-Marking.pdf. ON Semiconductor reserves the right to make changes without further notice to any products herein. ON Semiconductor makes no warranty, representation or guarantee regarding the suitability of its products for any particular purpose, nor does ON Semiconductor assume any liability arising out of the application or use of any product or circuit, and specifically disclaims any and all liability, including without limitation special, consequential or incidental damages. Buyer is responsible for its products and applications using ON Semiconductor products, including compliance with all laws, regulations and safety requirements or standards, regardless of any support or applications information provided by ON Semiconductor. "Typical" parameters which may be provided in ON Semiconductor data sheets and/or specifications can and do vary in different applications and actual performance may vary over time. All operating parameters, including "Typicals" must be validated for each customer application by customer's technical experts. ON Semiconductor does not convey any license under its patent rights nor the rights of others. ON Semiconductor products are not designed, intended, or authorized for use as a critical component in life support systems or any FDA Class 3 medical devices or medical devices with a same or similar classification in a foreign jurisdiction or any devices intended for implantation in the human body. Should Buyer purchase or use ON Semiconductor products for any such unintended or unauthorized application, Buyer shall indemnify and hold ON Semiconductor and its officers, employees, subsidiaries, affiliates, and distributors harmless against all claims, costs, damages, and expenses, and reasonable attorney fees arising out of, directly or indirectly, any claim of personal injury or death associated with such unintended or unauthorized use, even if such claim alleges that ON Semiconductor was negligent regarding the design or manufacture of the part. ON Semiconductor is an Equal Opportunity/Affirmative Action Employer. This literature is subject to all applicable copyright laws and is not for resale in any manner.

PUBLICATION ORDERING INFORMATION

LITERATURE FULFILLMENT:
Literature Distribution Center for ON Semiconductor
19521 E. 32nd Pkwy, Aurora, Colorado 80011 USA
Phone: 303-675-2175 or 800-344-3860 Toll Free USA/Canada
Fax: 303-675-2176 or 800-344-3867 Toll Free USA/Canada
Email: orderlit@onsemi.com

N. American Technical Support: 800-282-9855 Toll Free
USA/Canada
Europe, Middle East and Africa Technical Support:
Phone: 421 33 790 2910

ON Semiconductor Website: www.onsemi.com
Order Literature: <http://www.onsemi.com/orderlit>

For additional information, please contact your local Sales Representative

Mouser Electronics

Authorized Distributor

Click to View Pricing, Inventory, Delivery & Lifecycle Information:

ON Semiconductor:

[NCS2200SN1T1G](#) [NCS2200SN2T1G](#) [NCS2200SQ2T2G](#) [NCS2200SQLT1G](#) [NCS2202SN1T1G](#) [NCS2202SN2T1G](#)
[NCS2202SQ1T2G](#) [NCS2202SQ2T2G](#) [NCV2200SN1T1G](#) [NCS2200AMUT1G](#) [NCS2202AMUTBG](#)
[NCV2200AMUTBG](#)