

PLEASE CHECK WWW.MOLEX.COM FOR LATEST PART INFORMATION

Part Number: **0438600003**
Status: **Active**
Overview: Magnetic and Modular Jacks and Plugs
Description: Modular Jack, Right-Angle, Low Profile, Inverted, 6/4

Documents:

3D Model	Application Specification AS-43860-001-001 (PDF)
Drawing (PDF)	Packaging Specification PK-43860-004 (PDF)
Product Specification PS-43860-003 (PDF)	RoHS Certificate of Compliance (PDF)
Product Specification TS-43860-001-001 (PDF)	

Agency Certification

CSA	LR19980
UL	E107635

General

Product Family	Modular Jacks/Plugs
Series	43860
Component Type	PCB Jack
Magnetic	No
Overview	Magnetic and Modular Jacks and Plugs
Performance Category	3
Power over Ethernet (PoE)	N/A
Product Name	Modular Jack 6/4
UPC	800753918245

Physical

Boot Color	N/A
Color - Resin	Black
Durability (mating cycles max)	500
Flammability	94V-0
Inverted / Top Latch	Yes
Jack Height	13.21mm
Lightpipes/LEDs	None
Material - Metal	Phosphor Bronze
Material - Plating Mating	Gold
Material - Plating Termination	Tin
Material - Resin	High Temperature Thermoplastic
Net Weight	2.128/g
Orientation	Right Angle (Side Entry)
PCB Locator	Yes
PCB Retention	Yes
PCB Thickness - Recommended	1.60mm
Packaging Type	Tube
Pitch - Mating Interface	1.02mm
Pitch - Termination Interface	1.02mm
Plating min - Mating	1.270µm
Plating min - Termination	2.540µm
Ports	1
Positions / Loaded Contacts	6/4
Surface Mount Compatible (SMC)	No
Temperature Range - Operating	-40° to +85°C
Termination Interface: Style	Through Hole
Waterproof / Dustproof	No
Wire/Cable Type	N/A

Electrical

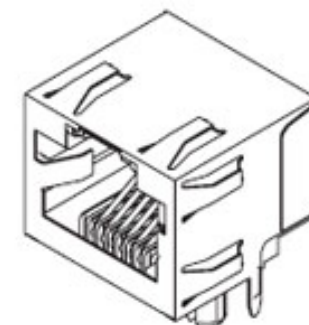

Series image - Reference only

EU ELV

Not Relevant

EU RoHS

Compliant

REACH SVHC

Not Contained Per -
ED/61/2018 (27 June
2018)

Halogen-Free

Status

Not Low-Halogen

For more information, please visit [Contact US](#)

China ROHS

ELV

RoHS Phthalates

China RoHS

Green Image

Not Relevant

Not Contained

Search Parts in this Series

[43860 Series](#)

Mates With

FCC 68 Plugs

Current - Maximum per Contact	1.5A
Shielded	No
Voltage - Maximum	150V AC (RMS)

Solder Process Data

Lead-free Process Capability	WAVE
------------------------------	------

Material Info**Reference - Drawing Numbers**

Application Specification	AS-43860-001-001
Packaging Specification	PK-43860-004
Product Specification	PS-43860-003, TS-43860-001-001
Sales Drawing	SD-43860-001

This document was generated on 10/26/2018

PLEASE CHECK WWW.MOLEX.COM FOR LATEST PART INFORMATION

Mouser Electronics

Authorized Distributor

Click to View Pricing, Inventory, Delivery & Lifecycle Information:

[Molex:](#)

[43860-0003](#)