

PART NAME

PLASTIBOX - STYLE M

PART No.

PT-11851-FMB

REVISION DATE

3-30-09

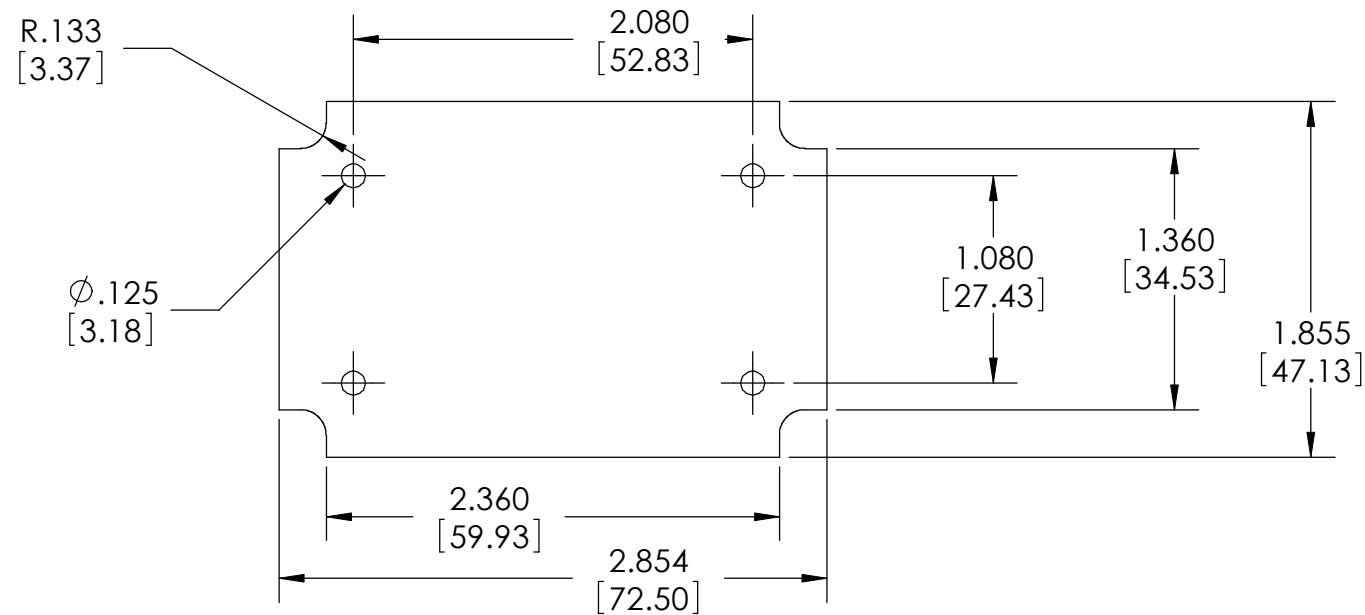
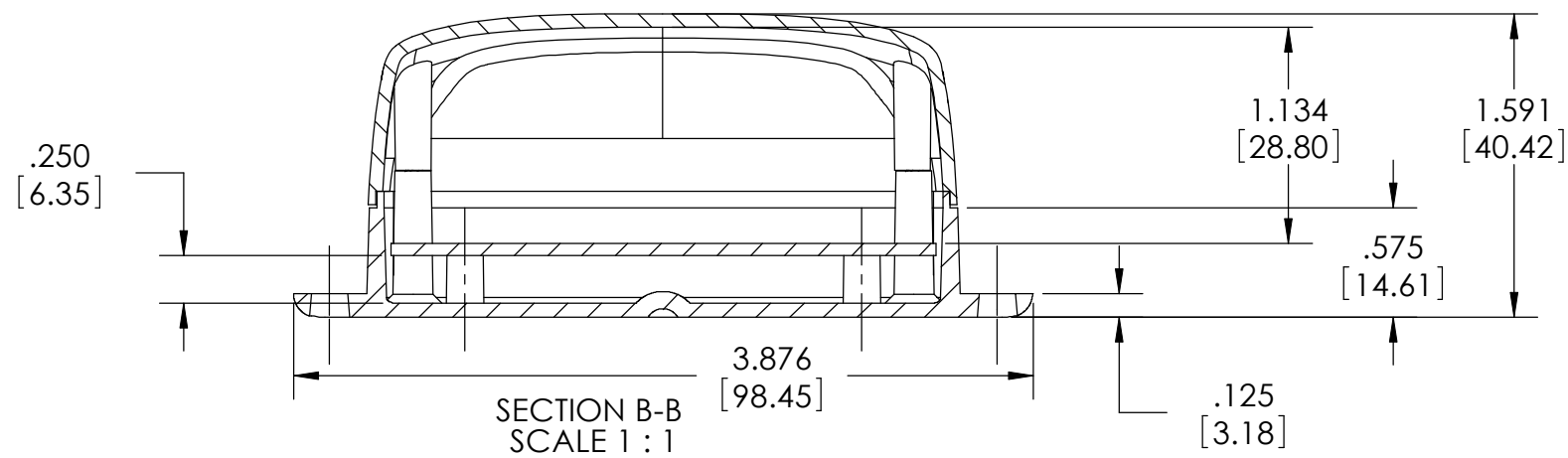
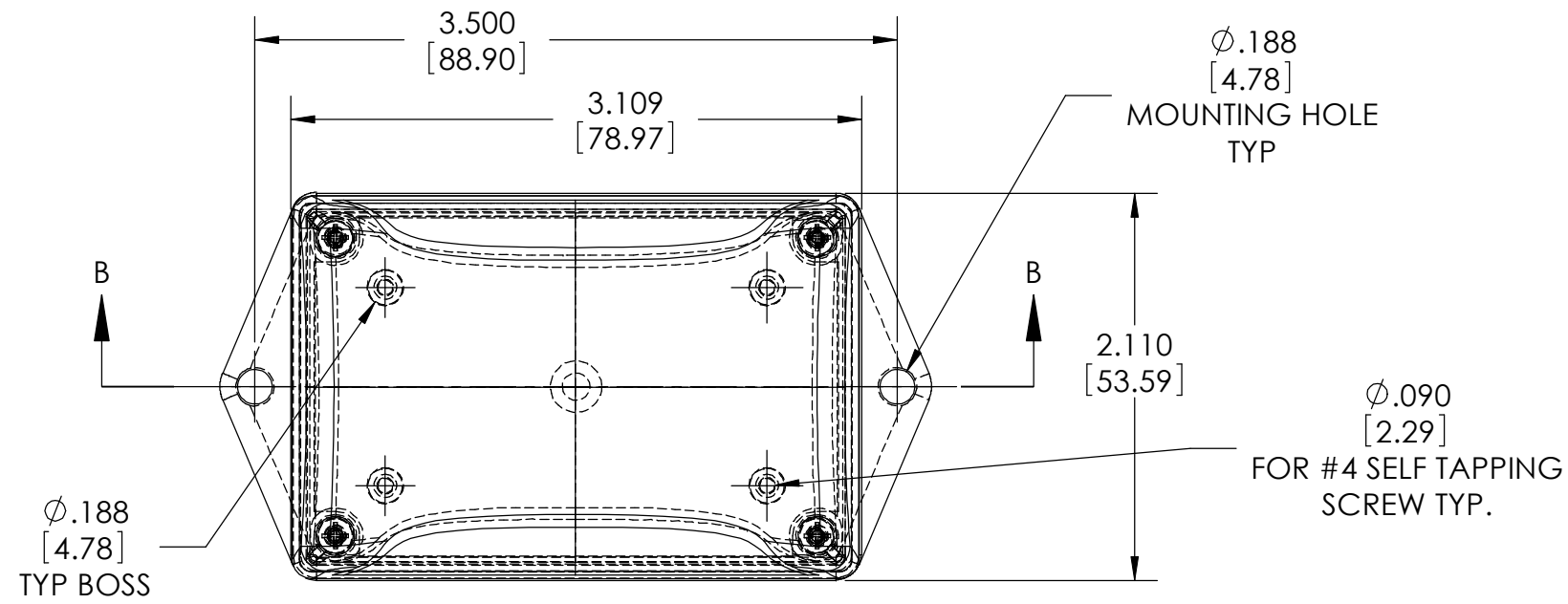

RECOMMENDED PC BOARD NOT FURNISHED

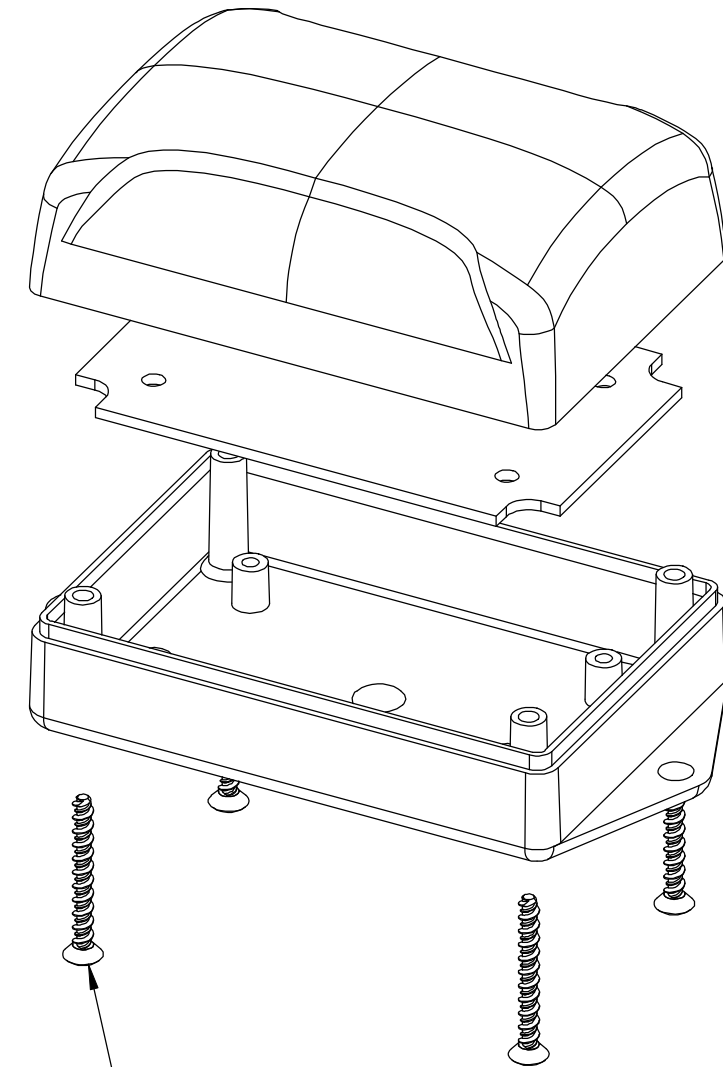

(4) SCREWS FURNISHED

MATERIAL:
ABS, BLACK, UL94V0

MAR RESISTANT TEXTURED SURFACE

Mouser Electronics

Authorized Distributor

Click to View Pricing, Inventory, Delivery & Lifecycle Information:

[Bud Industries:](#)

[PT-11851-FMB](#)