

### FEATURES

#### High Speed

- 80 MHz Bandwidth (3 dB,  $G = +1$ )
- 75 MHz Bandwidth (3 dB,  $G = +2$ )
- 1000 V/ $\mu$ s Slew Rate
- 50 ns Settling Time to 0.1% ( $V_O = 10$  V Step)

#### Ideal for Video Applications

- 30 MHz Bandwidth (0.1 dB,  $G = +2$ )
- 0.02% Differential Gain
- 0.04° Differential Phase

#### Low Noise

- 2.9 nV/ $\sqrt{\text{Hz}}$  Input Voltage Noise
- 13 pA/ $\sqrt{\text{Hz}}$  Inverting Input Current Noise

#### Low Power

- 8.0 mA Supply Current max
- 2.1 mA Supply Current (Power-Down Mode)

#### High Performance Disable Function

- Turn-Off Time 100 ns
- Break Before Make Guaranteed
- Input to Output Isolation of 64 dB (OFF State)

#### Flexible Operation

- Specified for  $\pm 5$  V and  $\pm 15$  V Operation
- $\pm 2.9$  V Output Swing Into a 150  $\Omega$  Load ( $V_S = \pm 5$  V)

### APPLICATIONS

- Professional Video Cameras
- Multimedia Systems
- NTSC, PAL & SECAM Compatible Systems
- Video Line Driver
- ADC/DAC Buffer
- DC Restoration Circuits

### CONNECTION DIAGRAM

8-Pin Plastic Mini-DIP (N), SOIC (R) and Cerdip (Q) Packages

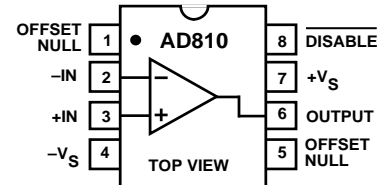

### PRODUCT DESCRIPTION

The AD810 is a composite and HDTV compatible, current feedback, video operational amplifier, ideal for use in systems such as multimedia, digital tape recorders and video cameras. The 0.1 dB flatness specification at bandwidth of 30 MHz ( $G = +2$ ) and the differential gain and phase of 0.02% and 0.04° (NTSC) make the AD810 ideal for any broadcast quality video system. All these specifications are under load conditions of 150  $\Omega$  (one 75  $\Omega$  back terminated cable).

The AD810 is ideal for power sensitive applications such as video cameras, offering a low power supply current of 8.0 mA max. The disable feature reduces the power supply current to only 2.1 mA, while the amplifier is not in use, to conserve power. Furthermore the AD810 is specified over a power supply range of  $\pm 5$  V to  $\pm 15$  V.

The AD810 works well as an ADC or DAC buffer in video systems due to its unity gain bandwidth of 80 MHz. Because the AD810 is a transimpedance amplifier, this bandwidth can be maintained over a wide range of gains while featuring a low noise of 2.9 nV/ $\sqrt{\text{Hz}}$  for wide dynamic range applications.

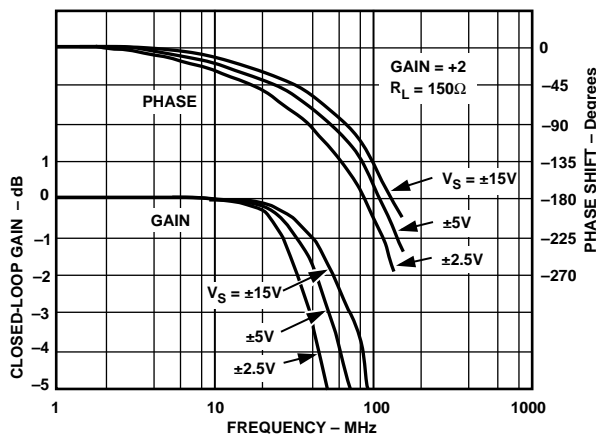

Closed-Loop Gain and Phase vs. Frequency,  $G = +2$ ,  $R_L = 150$ ,  $R_F = 715$   $\Omega$

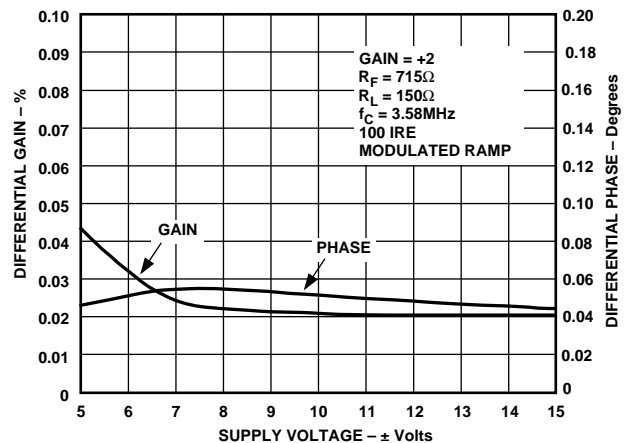

Differential Gain and Phase vs. Supply Voltage

### REV. A

Information furnished by Analog Devices is believed to be accurate and reliable. However, no responsibility is assumed by Analog Devices for its use, nor for any infringements of patents or other rights of third parties which may result from its use. No license is granted by implication or otherwise under any patent or patent rights of Analog Devices.

# AD810–SPECIFICATIONS (@ T<sub>A</sub> = +25°C and V<sub>S</sub> = ±15 V dc, R<sub>L</sub> = 150 Ω unless otherwise noted)

Parameter	Conditions	V <sub>S</sub>	AD810A			AD810S <sup>1</sup>			Units	
			Min	Typ	Max	Min	Typ	Max		
<b>DYNAMIC PERFORMANCE</b>										
3 dB Bandwidth	(G = +2) R <sub>FB</sub> = 715	±5 V	40	50		40	50		MHz	
	(G = +2) R <sub>FB</sub> = 715	±15 V	55	75		55	75		MHz	
	(G = +1) R <sub>FB</sub> = 1000	±15 V	40	80		40	80		MHz	
0.1 dB Bandwidth	(G = +10) R <sub>FB</sub> = 270	±15 V	50	65		50	65		MHz	
	(G = +2) R <sub>FB</sub> = 715	±5 V	13	22		13	22		MHz	
	(G = +2) R <sub>FB</sub> = 715	±15 V	15	30		15	30		MHz	
Full Power Bandwidth	V <sub>O</sub> = 20 V p-p, R <sub>L</sub> = 400 Ω	±15 V		16			16		MHz	
Slew Rate <sup>2</sup>	R <sub>L</sub> = 150 Ω	±5 V		350			350		V/μs	
	R <sub>L</sub> = 400 Ω	±15 V		1000			1000		V/μs	
	10 V Step, G = -1	±15 V		50			50		ns	
Settling Time to 0.1%	10 V Step, G = -1	±15 V		125			125		ns	
Settling Time to 0.01% Differential Gain	f = 3.58 MHz	±15 V		0.02	0.05		0.02	0.05	%	
	f = 3.58 MHz	±5 V		0.04	0.07		0.04	0.07	%	
	f = 3.58 MHz	±15 V		0.04	0.07		0.04	0.07	Degrees	
Differential Phase	f = 3.58 MHz	±15 V		0.04	0.07		0.04	0.07	Degrees	
Total Harmonic Distortion	f = 3.58 MHz	±5 V		0.045	0.08		0.045	0.08	Degrees	
	f = 10 MHz, V <sub>O</sub> = 2 V p-p									
	R <sub>L</sub> = 400 Ω, G = +2	±15 V		-61			-61		dBc	
<b>INPUT OFFSET VOLTAGE</b>										
Offset Voltage Drift	T <sub>MIN</sub> -T <sub>MAX</sub>	±5 V, ±15 V		1.5	6		1.5	6	mV	
		±5 V, ±15 V		2	7.5		4	15	mV	
				7			15		μV/°C	
<b>INPUT BIAS CURRENT</b>										
-Input +Input	T <sub>MIN</sub> -T <sub>MAX</sub> T <sub>MIN</sub> -T <sub>MAX</sub>	±5 V, ±15 V		0.7	5		0.8	5	μA	
		±5 V, ±15 V		2	7.5		2	10	μA	
<b>OPEN-LOOP TRANSRESISTANCE</b>										
DC VOLTAGE GAIN	T <sub>MIN</sub> -T <sub>MAX</sub> V <sub>O</sub> = ±10 V, R <sub>L</sub> = 400 Ω V <sub>O</sub> = ±2.5 V, R <sub>L</sub> = 100 Ω	±15 V	1.0	3.5		1.0	3.5		MΩ	
		±5 V	0.3	1.2		0.2	1.0		MΩ	
<b>COMMON-MODE REJECTION</b>										
V <sub>OS</sub>	T <sub>MIN</sub> -T <sub>MAX</sub> V <sub>CM</sub> = ±12 V V <sub>CM</sub> = ±2.5 V	±15 V	56	64		56	64		dB	
		±5 V	52	60		50	60		dB	
		±5 V, ±15 V		0.1	0.4		0.1	0.4		μA/V
±Input Current	T <sub>MIN</sub> -T <sub>MAX</sub>	±5 V, ±15 V		0.1	0.4		0.1	0.4	μA/V	
<b>POWER SUPPLY REJECTION</b>										
V <sub>OS</sub>	T <sub>MIN</sub> -T <sub>MAX</sub> T <sub>MIN</sub> -T <sub>MAX</sub>	±4.5 V to ±18 V	65	72		60	72		dB	
				0.05	0.3		0.05	0.3		μA/V
±Input Current	T <sub>MIN</sub> -T <sub>MAX</sub>	±4.5 V to ±18 V		0.05	0.3		0.05	0.3	μA/V	
<b>INPUT VOLTAGE NOISE</b>										
V <sub>OS</sub>	f = 1 kHz	±5 V, ±15 V		2.9			2.9		nV/√Hz	
<b>INPUT CURRENT NOISE</b>										
-I <sub>IN</sub> , f = 1 kHz +I <sub>IN</sub> , f = 1 kHz		±5 V, ±15 V		13			13		pA/√Hz	
		±5 V, ±15 V		1.5			1.5		pA/√Hz	
<b>INPUT COMMON-MODE VOLTAGE RANGE</b>										
Output Voltage Swing <sup>3</sup>	R <sub>L</sub> = 150 Ω, T <sub>MIN</sub> -T <sub>MAX</sub> R <sub>L</sub> = 400 Ω	±5 V	±2.5	±3.0		±2.5	±3		V	
		±15 V	±12.5	±12.9		±12.5	±12.9		V	
Short-Circuit Current Output Current	R <sub>L</sub> = 400 Ω, T <sub>MIN</sub> -T <sub>MAX</sub> T <sub>MIN</sub> -T <sub>MAX</sub>	±15 V	±12			±12			V	
		±15 V		150			150		mA	
Output Current	T <sub>MIN</sub> -T <sub>MAX</sub>	±5 V, ±15 V	40	60		30	60		mA	
<b>OUTPUT RESISTANCE</b>										
Open Loop (5 MHz)				15			15		Ω	
<b>INPUT CHARACTERISTICS</b>										
Input Resistance	+Input -Input +Input	±15 V	2.5	10		2.5	10		MΩ	
		±15 V		40			40		Ω	
		±15 V		2			2		pF	
Input Capacitance				2			2		pF	
<b>DISABLE CHARACTERISTICS<sup>4</sup></b>										
OFF Isolation OFF Output Impedance	f = 5 MHz, See Figure 43 See Figure 43			64 (R <sub>F</sub> + R <sub>G</sub> )  13 pF			64 (R <sub>F</sub> + R <sub>G</sub> )  13 pF		dB	

Parameter	Conditions	V <sub>S</sub>	AD810A			AD810S <sup>1</sup>			Units
			Min	Typ	Max	Min	Typ	Max	
Turn On Time <sup>5</sup>	Z <sub>OUT</sub> = Low, See Figure 54 Z <sub>OUT</sub> = High Disable Pin = 0 V	±5 V	170			170			ns
Turn Off Time			100			100			ns
Disable Pin Current			50 75			50 75			μA
Min Disable Pin Current to Disable	T <sub>MIN</sub> -T <sub>MAX</sub>	±15 V	290 400			290 400			μA
POWER SUPPLY									
Operating Range	+25°C to T <sub>MAX</sub> T <sub>MIN</sub>		±2.5		±18	±2.5		±18	V
Quiescent Current		±5 V	±3.0		±18	±3.5		±18	V
		±15 V		6.7	7.5		6.7	7.5	mA
	T <sub>MIN</sub> -T <sub>MAX</sub>	±5 V, ±15 V		6.8	8.0		6.8	8.0	mA
Power-Down Current		±5 V		8.3	10.0		9	11.0	mA
		±15 V		1.8	2.3		1.8	2.3	mA
				2.1	2.8		2.1	2.8	mA

### NOTES

- <sup>1</sup>See Analog Devices Military Data Sheet for 883B Specifications.
- <sup>2</sup>Slew rate measurement is based on 10% to 90% rise time with the amplifier configured for a gain of -10.
- <sup>3</sup>Voltage Swing is defined as useful operating range, not the saturation range.
- <sup>4</sup>Disable guaranteed break before make.
- <sup>5</sup>Turn On Time is defined with ±5 V supplies using complementary output CMOS to drive the disable pin.

Specifications subject to change without notice.

### ABSOLUTE MAXIMUM RATINGS<sup>1</sup>

Supply Voltage	±18 V
Internal Power Dissipation <sup>2</sup>	Observe Derating Curves
Output Short Circuit Duration	Observe Derating Curves
Common-Mode Input Voltage	±V <sub>S</sub>
Differential Input Voltage	±6 V
Storage Temperature Range	
Plastic DIP	-65°C to +125°C
Cerdip	-65°C to +150°C
Small Outline IC	-65°C to +125°C
Operating Temperature Range	
AD810A	-40°C to +85°C
AD810S	-55°C to +125°C
Lead Temperature Range (Soldering 60 sec)	+300°C

### NOTES

- <sup>1</sup>Stresses above those listed under "Absolute Maximum Ratings" may cause permanent damage to the device. This is a stress rating only and functional operation of the device at these or any other conditions above those indicated in the operational section of this specification is not implied. Exposure to absolute maximum rating conditions for extended periods may affect device reliability.
- <sup>2</sup>8-Pin Plastic Package: θ<sub>JA</sub> = 90°C/Watt; 8-Pin Cerdip Package: θ<sub>JA</sub> = 110°C/Watt; 8-Pin SOIC Package: θ<sub>JA</sub> = 150°C/Watt.

### ESD SUSCEPTIBILITY

ESD (electrostatic discharge) sensitive device. Electrostatic charges as high as 4000 volts, which readily accumulate on the human body and on test equipment, can discharge without detection. Although the AD810 features ESD protection circuitry, permanent damage may still occur on these devices if they are subjected to high energy electrostatic discharges. Therefore, proper ESD precautions are recommended to avoid any performance degradation or loss of functionality.

### ORDERING GUIDE

Model	Temperature Range	Package Description	Package Option
AD810AN	-40°C to +85°C	8-Pin Plastic DIP	N-8
AD810AR	-40°C to +85°C	8-Pin Plastic SOIC	R-8
AD810AR-REEL	-40°C to +85°C	8-Pin Plastic SOIC	R-8
5962-9313201MPA	-55°C to +125°C	8-Pin Cerdip	Q-8

### MAXIMUM POWER DISSIPATION

The maximum power that can be safely dissipated by the AD810 is limited by the associated rise in junction temperature. For the plastic packages, the maximum safe junction temperature is 145°C. For the cerdip package, the maximum junction temperature is 175°C. If these maximums are exceeded momentarily, proper circuit operation will be restored as soon as the die temperature is reduced. Leaving the device in the "overheated" condition for an extended period can result in device burnout. To ensure proper operation, it is important to observe the derating curves.

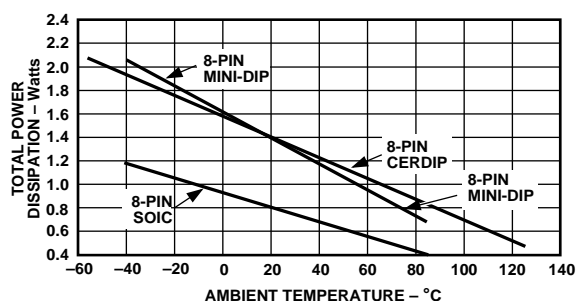

Maximum Power Dissipation vs. Temperature

While the AD810 is internally short circuit protected, this may not be sufficient to guarantee that the maximum junction temperature is not exceeded under all conditions.

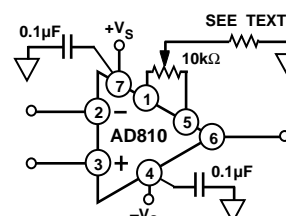

Offset Null Configuration

# AD810—Typical Characteristics

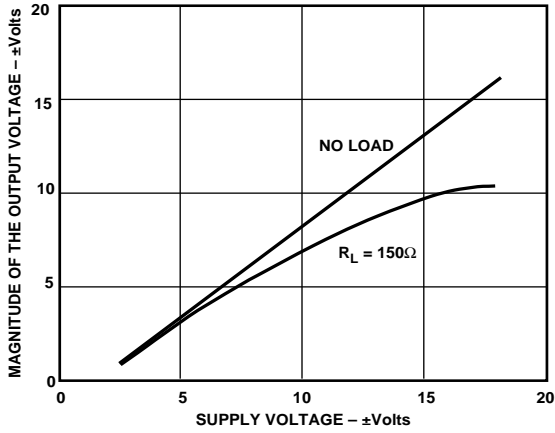

Figure 1. Input Common-Mode Voltage Range vs. Supply Voltage

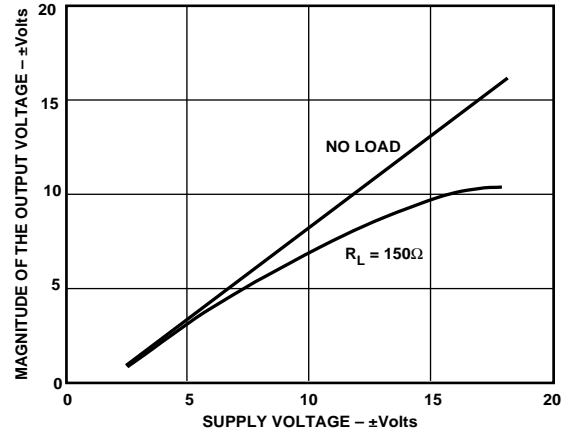

Figure 2. Output Voltage Swing vs. Supply

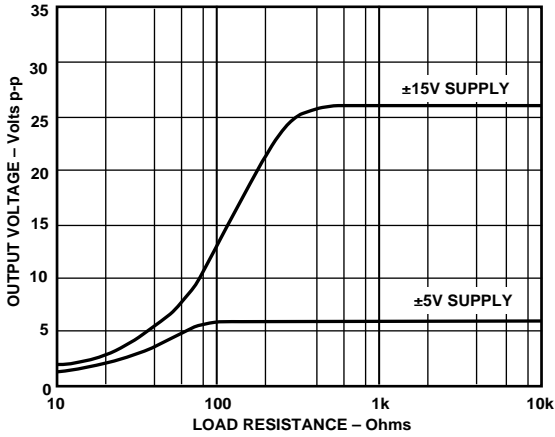

Figure 3. Output Voltage Swing vs. Load Resistance

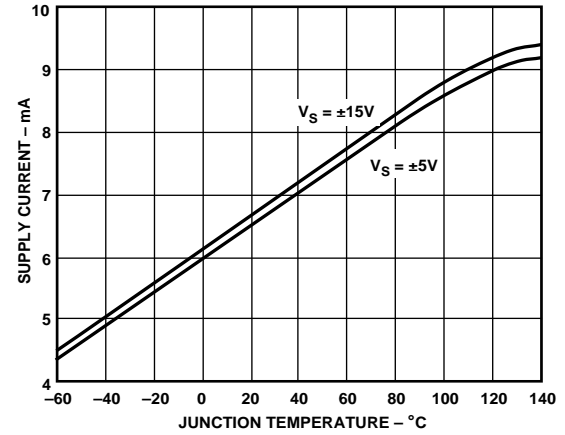

Figure 4. Supply Current vs. Junction Temperature

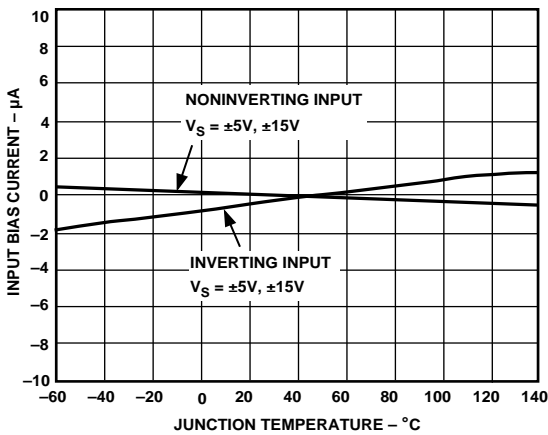

Figure 5. Input Bias Current vs. Temperature

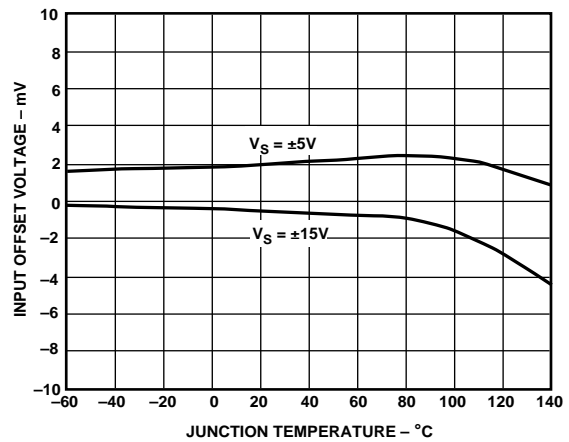

Figure 6. Input Offset Voltage vs. Junction Temperature

# Typical Characteristics–AD810

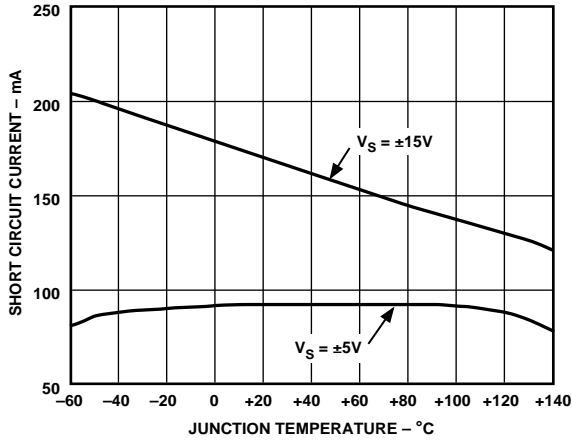

Figure 7. Short Circuit Current vs. Temperature

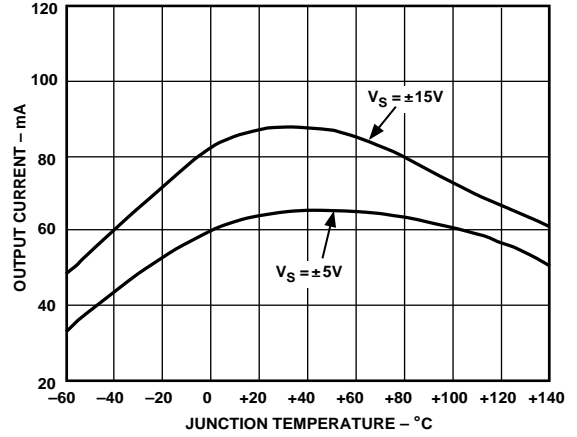

Figure 8. Linear Output Current vs. Temperature

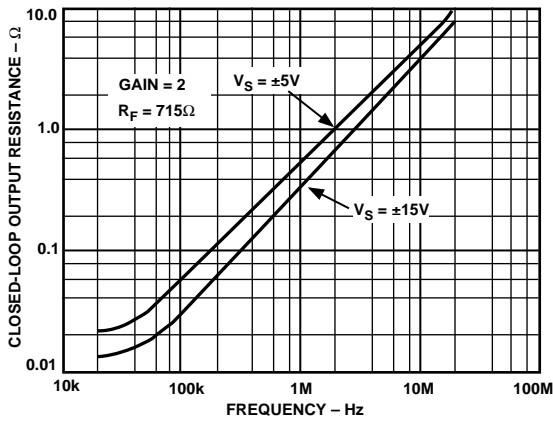

Figure 9. Closed-Loop Output Resistance vs. Frequency

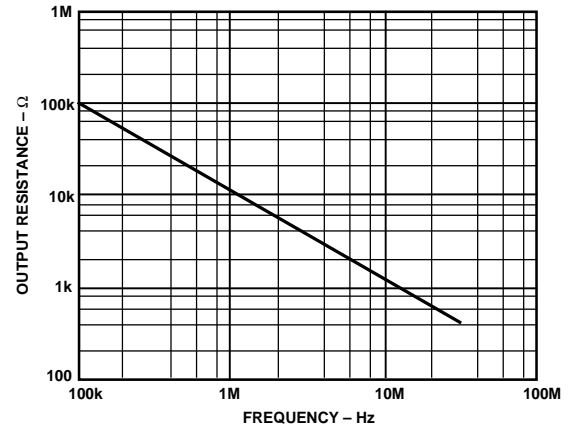

Figure 10. Output Resistance vs. Frequency, Disabled State

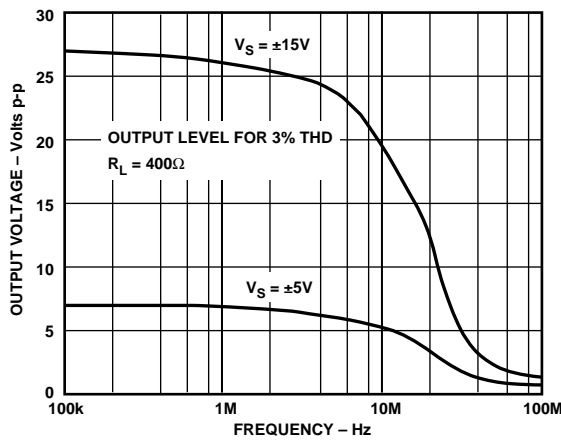

Figure 11. Large Signal Frequency Response

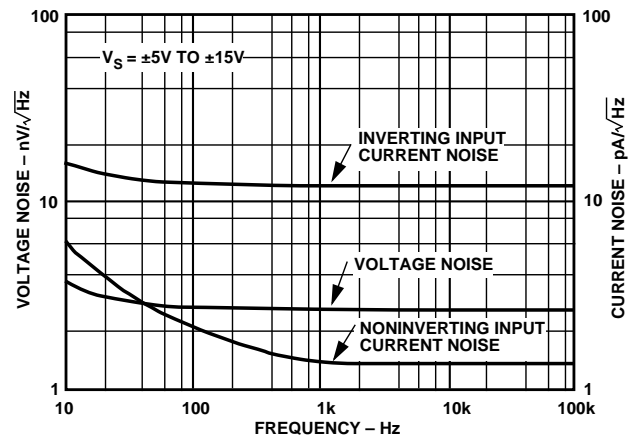

Figure 12. Input Voltage and Current Noise vs. Frequency

# AD810—Typical Characteristics

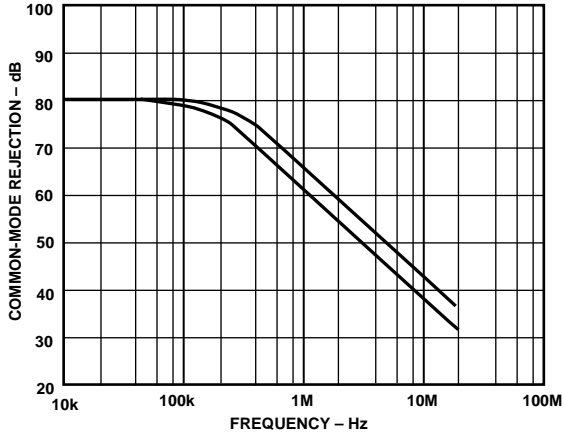

Figure 13. Common-Mode Rejection vs. Frequency

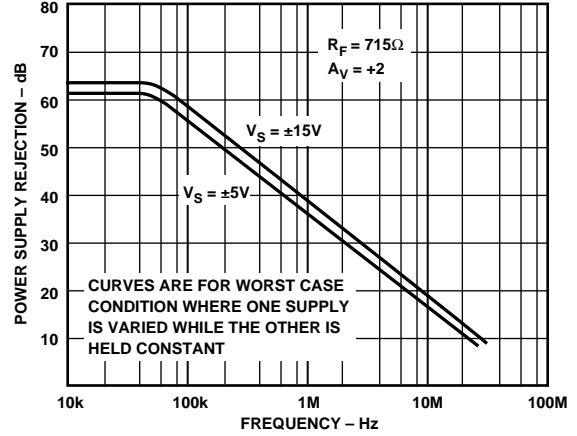

Figure 14. Power Supply Rejection vs. Frequency

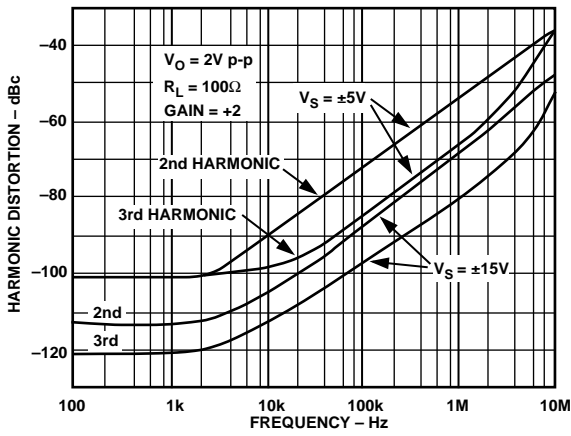

Figure 15. Harmonic Distortion vs. Frequency ( $R_L = 100\Omega$ )

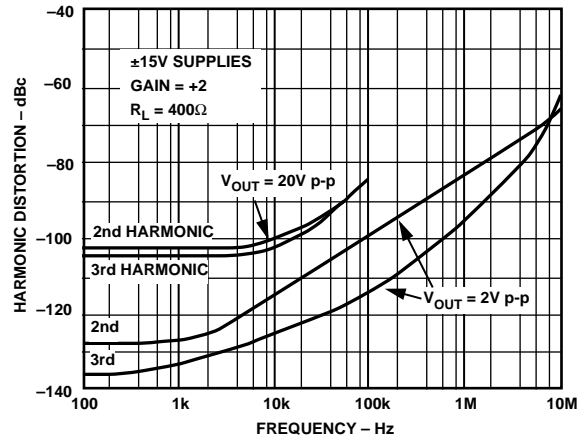

Figure 16. Harmonic Distortion vs. Frequency ( $R_L = 400\Omega$ )

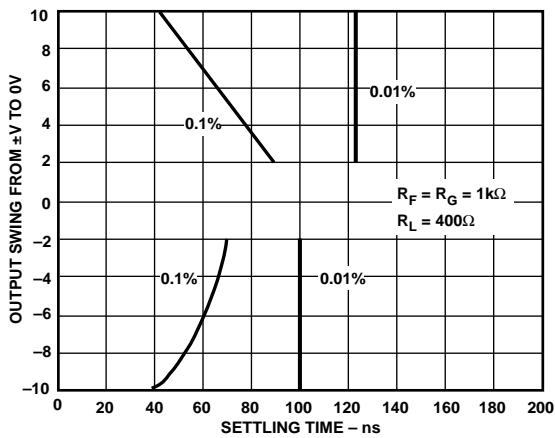

Figure 17. Output Swing and Error vs. Settling Time

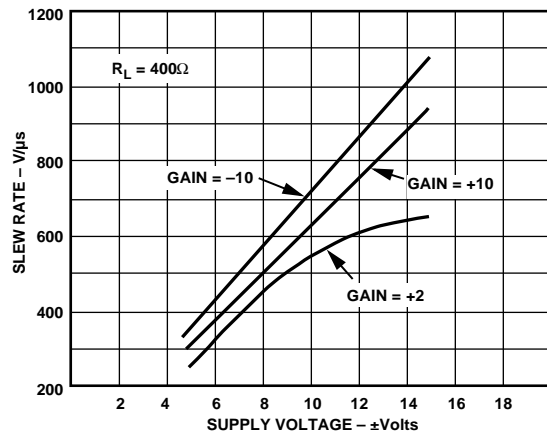

Figure 18. Slew Rate vs. Supply Voltage

# Typical Characteristics, Noninverting Connection-AD810

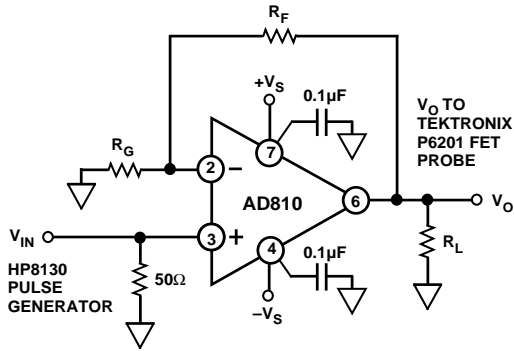

Figure 19. Noninverting Amplifier Connection

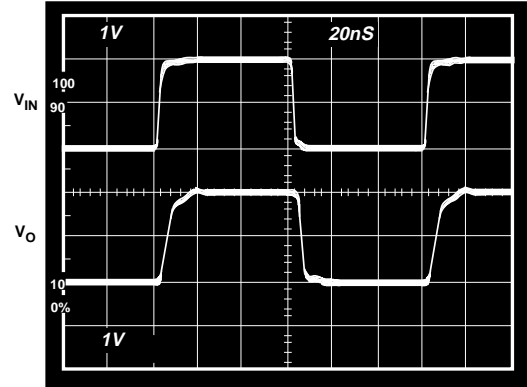

Figure 20. Small Signal Pulse Response, Gain = +1,  $R_F = 1\text{ k}\Omega$ ,  $R_L = 150\ \Omega$ ,  $V_S = \pm 15\text{ V}$

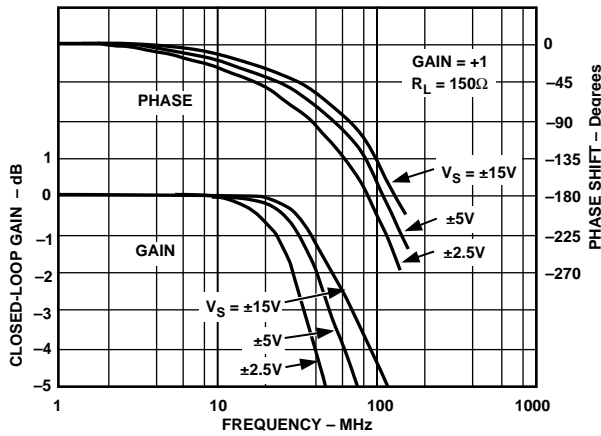

Figure 21. Closed-Loop Gain and Phase vs. Frequency,  $G = +1$ ,  $R_F = 1\text{ k}\Omega$  for  $\pm 15\text{ V}$ ,  $910\ \Omega$  for  $\pm 5\text{ V}$  and  $\pm 2.5\text{ V}$

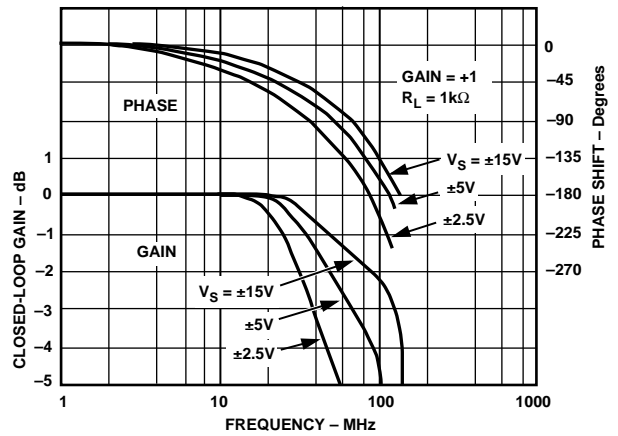

Figure 22. Closed-Loop Gain and Phase vs. Frequency,  $G = +1$ ,  $R_F = 1\text{ k}\Omega$  for  $\pm 15\text{ V}$ ,  $910\ \Omega$  for  $\pm 5\text{ V}$  and  $\pm 2.5\text{ V}$

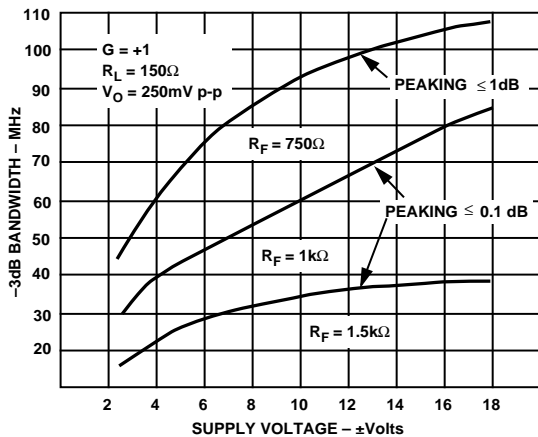

Figure 23. Bandwidth vs. Supply Voltage, Gain = +1,  $R_L = 150\ \Omega$

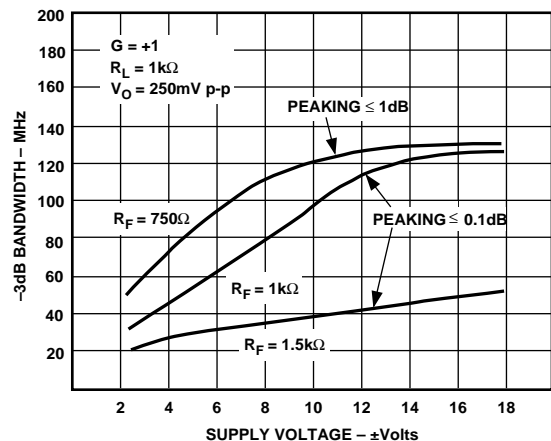

Figure 24. -3 dB Bandwidth vs. Supply Voltage  $G = +1$ ,  $R_L = 1\text{ k}\Omega$

# AD810—Typical Characteristics, Noninverting Connection

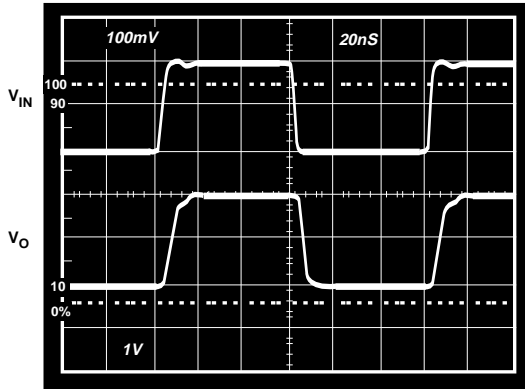

Figure 25. Small Signal Pulse Response, Gain = +10,  $R_F = 442\ \Omega$ ,  $R_L = 150\ \Omega$ ,  $V_S = \pm 15\ V$

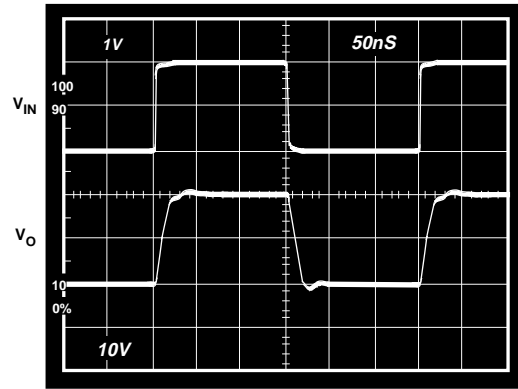

Figure 26. Large Signal Pulse Response, Gain = +10,  $R_F = 442\ \Omega$ ,  $R_L = 400\ \Omega$ ,  $V_S = \pm 15\ V$

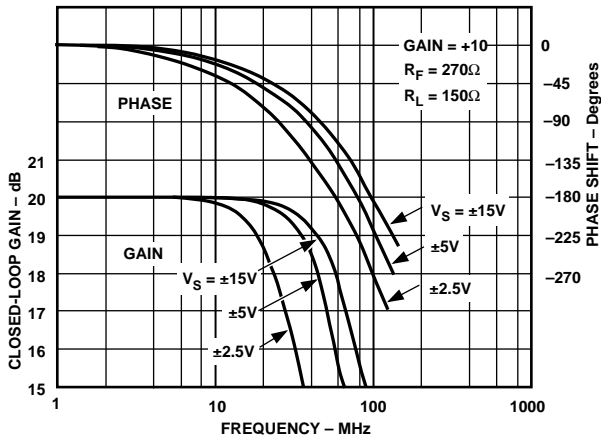

Figure 27. Closed-Loop Gain and Phase vs. Frequency,  $G = +10$ ,  $R_L = 150\ \Omega$

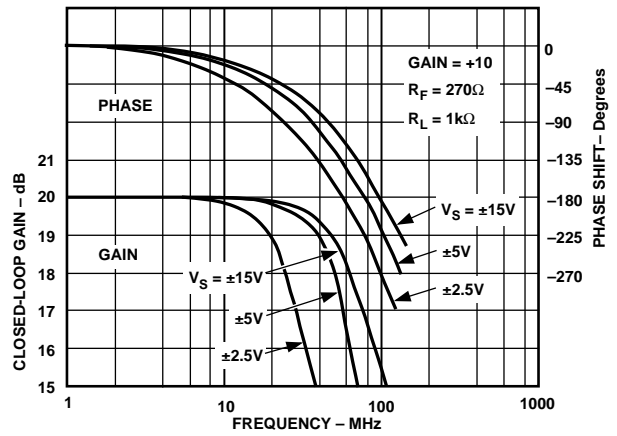

Figure 28. Closed-Loop Gain and Phase vs. Frequency,  $G = +10$ ,  $R_L = 1\ k\Omega$

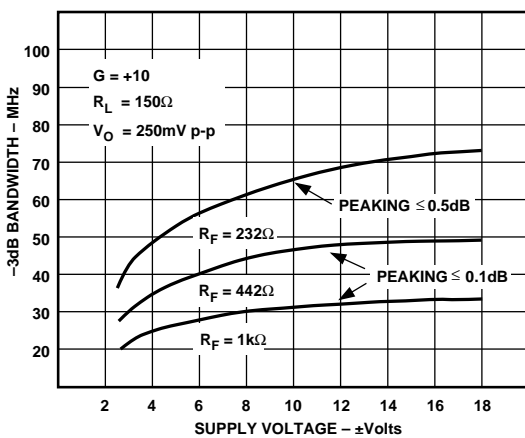

Figure 29. -3 dB Bandwidth vs. Supply Voltage, Gain = +10,  $R_L = 150\ \Omega$

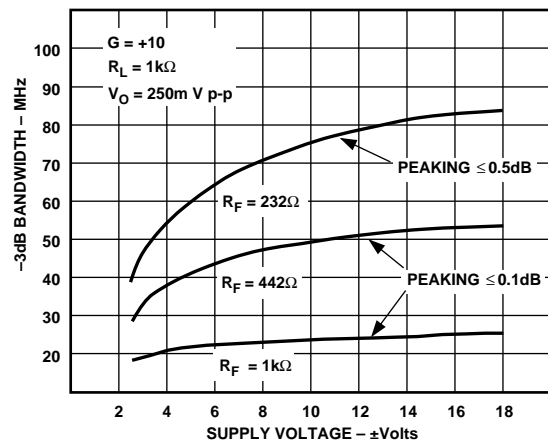

Figure 30. -3 dB Bandwidth vs. Supply Voltage, Gain = +10,  $R_L = 1\ k\Omega$



# Typical Characteristics, Inverting Connection-AD810

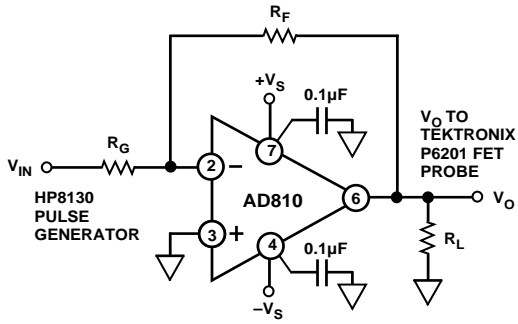

Figure 31. Inverting Amplifier Connection

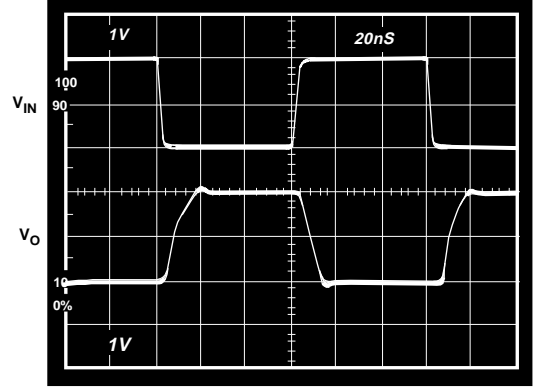

Figure 32. Small Signal Pulse Response, Gain = -1,  $R_F = 681 \Omega$ ,  $R_L = 150 \Omega$ ,  $V_S = \pm 5 V$

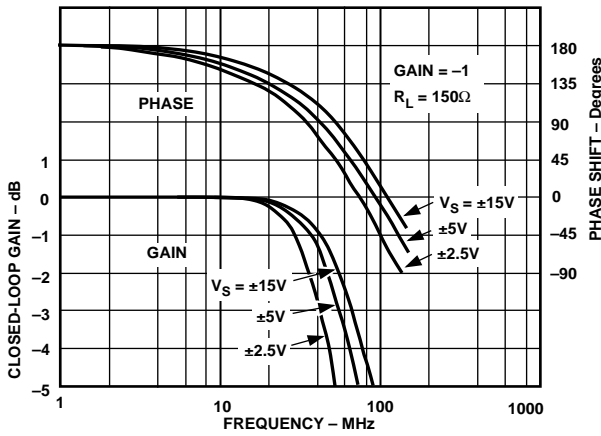

Figure 33. Closed-Loop Gain and Phase vs. Frequency  $G = -1$ ,  $R_L = 150 \Omega$ ,  $R_F = 681 \Omega$  for  $\pm 15 V$ ,  $620 \Omega$  for  $\pm 5 V$  and  $\pm 2.5 V$

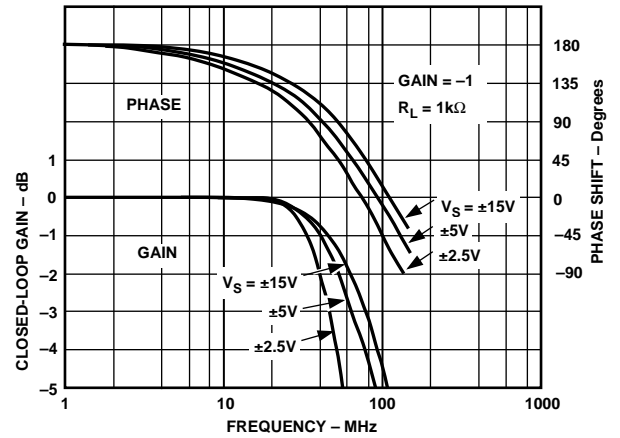

Figure 34. Closed-Loop Gain and Phase vs. Frequency,  $G = -1$ ,  $R_L = 1 k\Omega$ ,  $R_F = 681 \Omega$  for  $V_S = \pm 15 V$ ,  $620 \Omega$  for  $\pm 5 V$  and  $\pm 2.5 V$

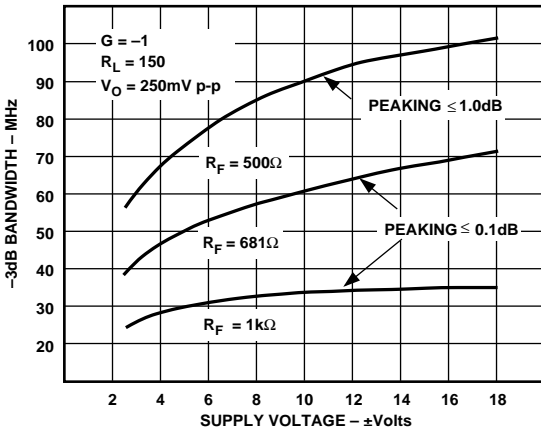

Figure 35. -3 dB Bandwidth vs. Supply Voltage, Gain = -1,  $R_L = 150 \Omega$

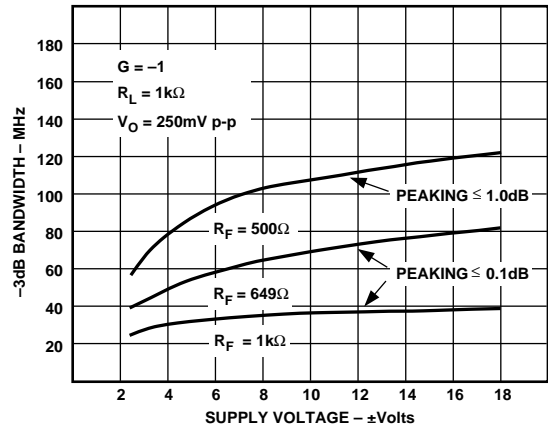

Figure 36. -3 dB Bandwidth vs. Supply Voltage, Gain = -1,  $R_L = 1 k\Omega$

# AD810 – Typical Characteristics, Inverting Connection

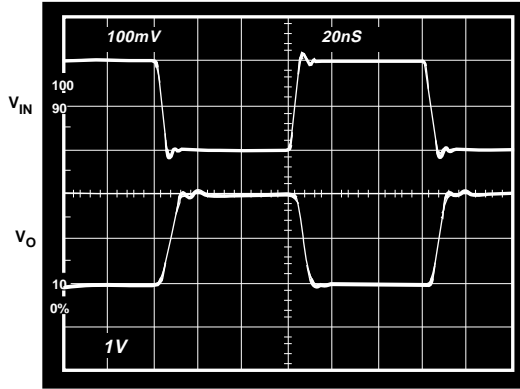

Figure 37. Small Signal Pulse Response, Gain = -10,  $R_F = 442 \Omega$ ,  $R_L = 150 \Omega$ ,  $V_S = \pm 15 V$

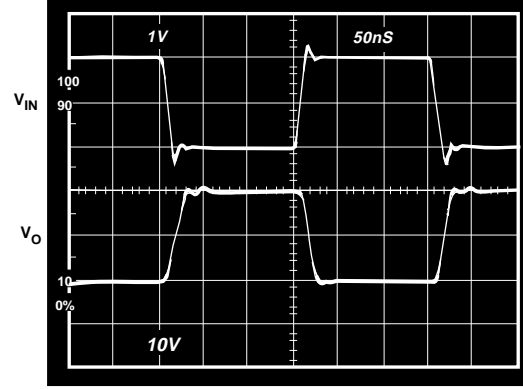

Figure 38. Large Signal Pulse Response, Gain = -10,  $R_F = 442 \Omega$ ,  $R_L = 400 \Omega$ ,  $V_S = \pm 15 V$

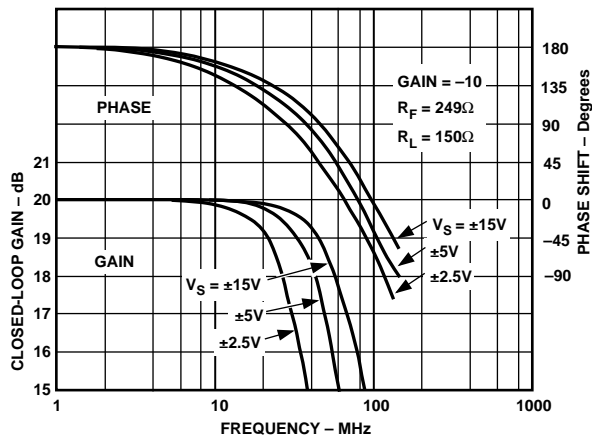

Figure 39. Closed-Loop Gain and Phase vs. Frequency,  $G = -10$ ,  $R_L = 150 \Omega$

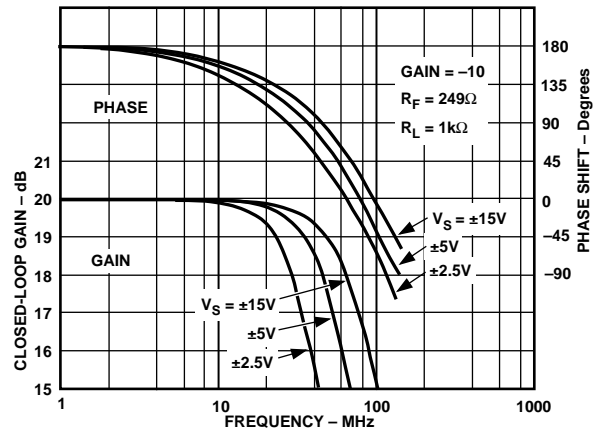

Figure 40. Closed-Loop Gain and Phase vs. Frequency,  $G = -10$ ,  $R_L = 1 k\Omega$

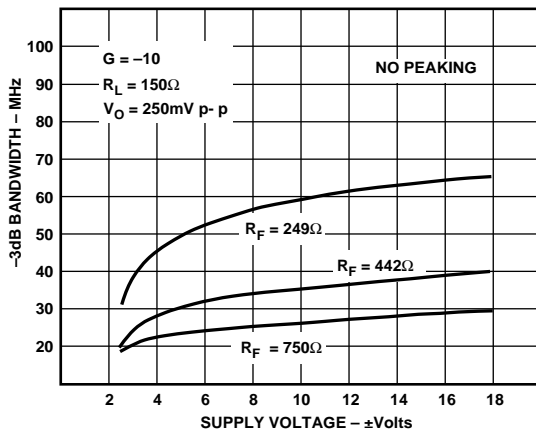

Figure 41. -3 dB Bandwidth vs. Supply Voltage,  $G = -10$ ,  $R_L = 150 \Omega$

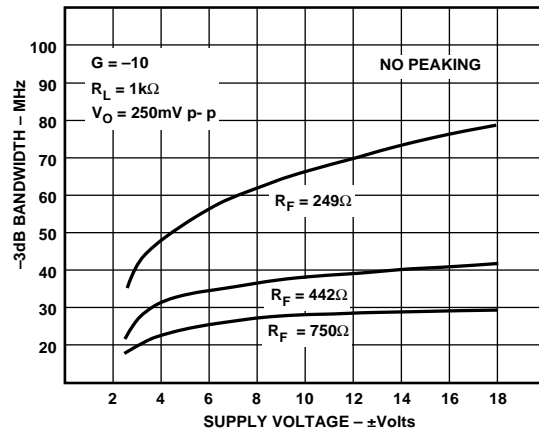

Figure 42. -3 dB Bandwidth vs. Supply Voltage,  $G = -10$ ,  $R_L = 1 k\Omega$

## GENERAL DESIGN CONSIDERATIONS

The AD810 is a current feedback amplifier optimized for use in high performance video and data acquisition systems. Since it uses a current feedback architecture, its closed-loop bandwidth depends on the value of the feedback resistor. Table I below contains recommended resistor values for some useful closed-loop gains and supply voltages. As you can see in the table, the closed-loop bandwidth is not a strong function of gain, as it would be for a voltage feedback amp. The recommended resistor values will result in maximum bandwidths with less than 0.1 dB of peaking in the gain vs. frequency response.

The -3 dB bandwidth is also somewhat dependent on the power supply voltage. Lowering the supplies increases the values of internal capacitances, reducing the bandwidth. To compensate for this, smaller values of feedback resistor are sometimes used at lower supply voltages. The characteristic curves illustrate that bandwidths of over 100 MHz on 30 V total and over 50 MHz on 5 V total supplies can be achieved.

**Table I. -3 dB Bandwidth vs. Closed-Loop Gain and Resistance Values ( $R_L = 150 \Omega$ )**

$V_S = \pm 15 \text{ V}$ Closed-Loop Gain	$R_{FB}$	$R_G$	-3 dB BW (MHz)
+1	1 k $\Omega$		80
+2	715 $\Omega$	715 $\Omega$	75
+10	270 $\Omega$	30 $\Omega$	65
-1	681 $\Omega$	681 $\Omega$	70
-10	249 $\Omega$	24.9 $\Omega$	65
$V_S = \pm 5 \text{ V}$ Closed-Loop Gain	$R_{FB}$	$R_G$	-3 dB BW (MHz)
+1	910 $\Omega$		50
+2	715 $\Omega$	715 $\Omega$	50
+10	270 $\Omega$	30 $\Omega$	50
-1	620 $\Omega$	620 $\Omega$	55
-10	249 $\Omega$	24.9 $\Omega$	50

## ACHIEVING VERY FLAT GAIN RESPONSE AT HIGH FREQUENCY

Achieving and maintaining gain flatness of better than 0.1 dB above 10 MHz is not difficult if the recommended resistor values are used. The following issues should be considered to ensure consistently excellent results.

### CHOICE OF FEEDBACK AND GAIN RESISTOR

Because the 3 dB bandwidth depends on the feedback resistor, the fine scale flatness will, to some extent, vary with feedback resistor tolerance. It is recommended that resistors with a 1% tolerance be used if it is desired to maintain exceptional flatness over a wide range of production lots.

## PRINTED CIRCUIT BOARD LAYOUT

As with all wideband amplifiers, PC board parasitics can affect the overall closed-loop performance. Most important are stray capacitances at the output and inverting input nodes. (An added capacitance of 2 pF between the inverting input and ground will add about 0.2 dB of peaking in the gain of 2 response, and increase the bandwidth to 105 MHz.) A space (3/16" is plenty) should be left around the signal lines to minimize coupling. Also, signal lines connecting the feedback and gain resistors should be short enough so that their associated inductance does not cause high frequency gain errors. Line lengths less than 1/4" are recommended.

## QUALITY OF COAX CABLE

Optimum flatness when driving a coax cable is possible only when the driven cable is terminated at each end with a resistor matching its characteristic impedance. If coax were ideal, then the resulting flatness would not be affected by the length of the cable. While outstanding results can be achieved using inexpensive cables, some variation in flatness due to varying cable lengths is to be expected.

## POWER SUPPLY BYPASSING

Adequate power supply bypassing can be critical when optimizing the performance of a high frequency circuit. Inductance in the power supply leads can contribute to resonant circuits that produce peaking in the amplifier's response. In addition, if large current transients must be delivered to the load, then bypass capacitors (typically greater than 1  $\mu\text{F}$ ) will be required to provide the best settling time and lowest distortion. Although the recommended 0.1  $\mu\text{F}$  power supply bypass capacitors will be sufficient in most applications, more elaborate bypassing (such as using two paralleled capacitors) may be required in some cases.

## POWER SUPPLY OPERATING RANGE

The AD810 will operate with supplies from  $\pm 18 \text{ V}$  down to about  $\pm 2.5 \text{ V}$ . On  $\pm 2.5 \text{ V}$  the low distortion output voltage swing will be better than 1 V peak to peak. Single supply operation can be realized with excellent results by arranging for the input common-mode voltage to be biased at the supply midpoint.

## OFFSET NULLING

A 10 k $\Omega$  pot connected between Pins 1 and 5, with its wiper connected to  $V_+$ , can be used to trim out the inverting input current (with about  $\pm 20 \mu\text{A}$  of range). For closed-loop gains above about 5, this may not be sufficient to trim the output offset voltage to zero. Tie the pot's wiper to ground through a large value resistor (50 k $\Omega$  for  $\pm 5 \text{ V}$  supplies, 150 k $\Omega$  for  $\pm 15 \text{ V}$  supplies) to trim the output to zero at high closed-loop gains.

# AD810

## CAPACITIVE LOADS

When used with the appropriate feedback resistor, the AD810 can drive capacitive loads exceeding 1000 pF directly without oscillation. By using the curves in Figure 45 to choose the resistor value, less than 1 dB of peaking can easily be achieved without sacrificing much bandwidth. Note that the curves were generated for the case of a 10 kΩ load resistor, for smaller load resistances, the peaking will be less than indicated by Figure 45.

Another method of compensating for large load capacitances is to insert a resistor in series with the loop output as shown in Figure 43. In most cases, less than 50 Ω is all that is needed to achieve an extremely flat gain response.

Figures 44 to 46 illustrate the outstanding performance that can be achieved when driving a 1000 pF capacitor.

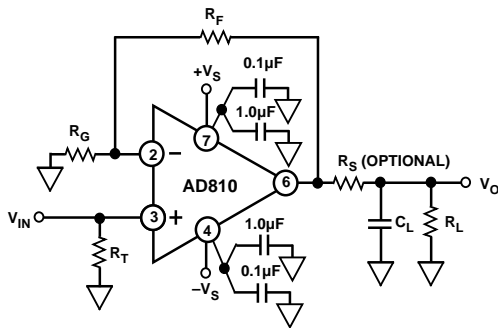

Figure 43. Circuit Options for Driving a Large Capacitive Load

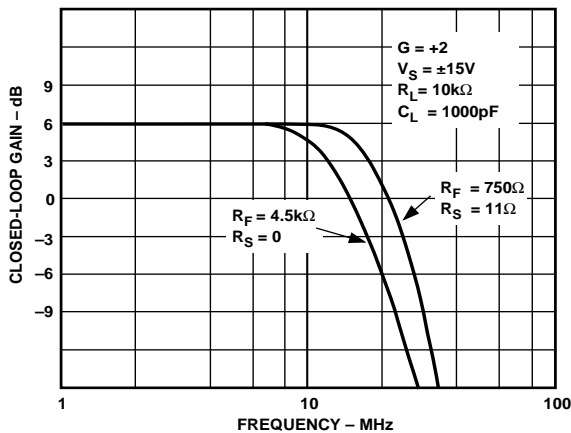

Figure 44. Performance Comparison of Two Methods for Driving a Large Capacitive Load

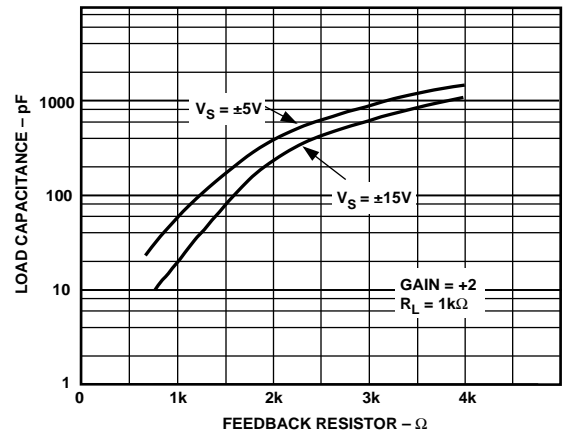

Figure 45. Max Load Capacitance for Less than 1 dB of Peaking vs. Feedback Resistor

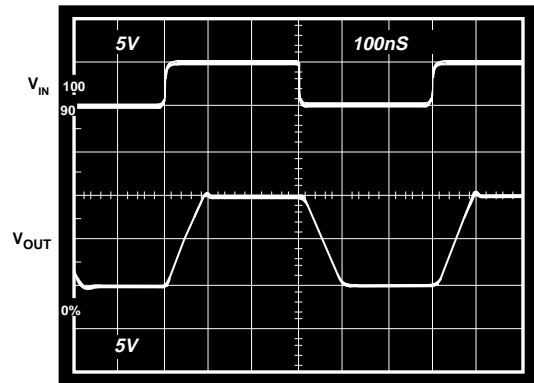

Figure 46. AD810 Driving a 1000 pF Load, Gain = +2,  $R_F = 750 \Omega$ ,  $R_S = 11 \Omega$ ,  $R_L = 10 \text{ k}\Omega$

## DISABLE MODE

By pulling the voltage on Pin 8 to common (0 V), the AD810 can be put into a disabled state. In this condition, the supply current drops to less than 2.8 mA, the output becomes a high impedance, and there is a high level of isolation from input to output. In the case of a line driver for example, the output impedance will be about the same as for a 1.5 kΩ resistor (the feedback plus gain resistors) in parallel with a 13 pF capacitor (due to the output) and the input to output isolation will be better than 65 dB at 1 MHz.

Leaving the disable pin disconnected (floating) will leave the AD810 operational in the enabled state.

In cases where the amplifier is driving a high impedance load, the input to output isolation will decrease significantly if the input signal is greater than about 1.2 V peak to peak. The isolation can be restored back to the 65 dB level by adding a dummy load (say 150 Ω) at the amplifier output. This will attenuate the feedthrough signal. (This is not an issue for multiplexer applications where the outputs of multiple AD810s are tied together as long as at least one channel is in the ON state.) The input impedance of the disable pin is about 35 kΩ in parallel with a few pF. When grounded, about 50 μA flows out

of the disable the disable pin for  $\pm 5$  V supplies. If driven by complementary output CMOS logic (such as the 74HC04), the disable time (until the output goes high impedance) is about 100 ns and the enable time (to low impedance output) is about 170 ns on  $\pm 5$  V supplies. The enable time can be extended to about 750 ns by using open drain logic such as the 74HC05.

When operated on  $\pm 15$  V supplies, the AD810 disable pin may be driven by open drain logic such as the 74C906. In this case, adding a 10 k $\Omega$  pull-up resistor from the disable pin to the plus supply will decrease the enable time to about 150 ns. If there is a nonzero voltage present on the amplifier's output at the time it is switched to the disabled state, some additional decay time will be required for the output voltage to relax to zero. The total time for the output to go to zero will generally be about 250 ns and is somewhat dependent on the load impedance.

**OPERATION AS A VIDEO LINE DRIVER**

The AD810 is designed to offer outstanding performance at closed-loop gains of one or greater. At a gain of 2, the AD810 makes an excellent video line driver. The low differential gain and phase errors and wide -0.1 dB bandwidth are nearly independent of supply voltage and load (as seen in Figures 49 and 50).

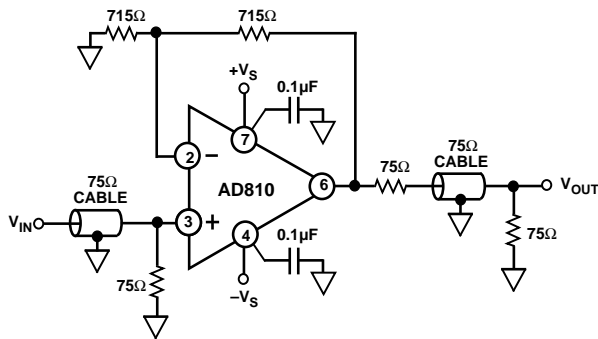

Figure 47. A Video Line Driver Operating at a Gain of +2

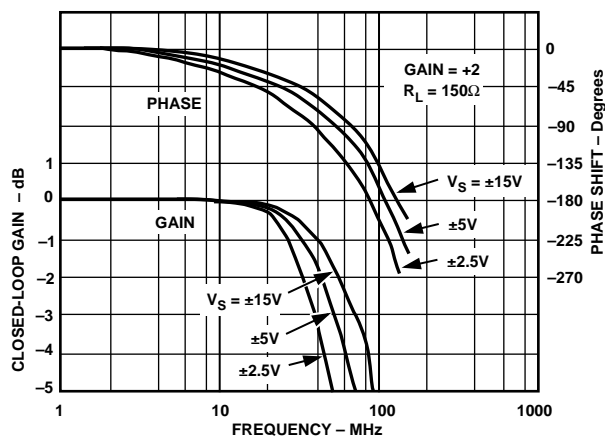

Figure 48. Closed-Loop Gain and Phase vs. Frequency,  $G = +2$ ,  $R_L = 150 \Omega$ ,  $R_F = 715 \Omega$

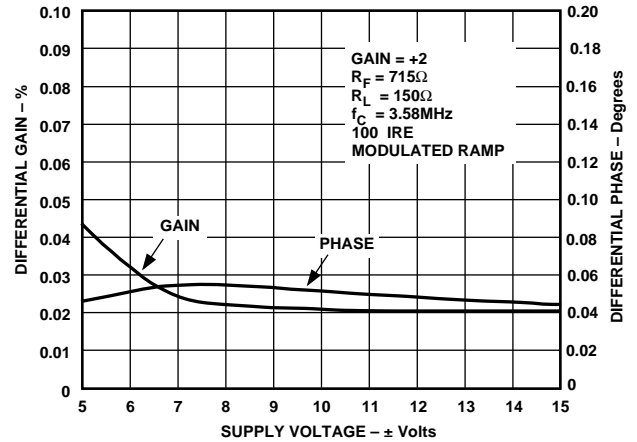

Figure 49. Differential Gain and Phase vs. Supply Voltage

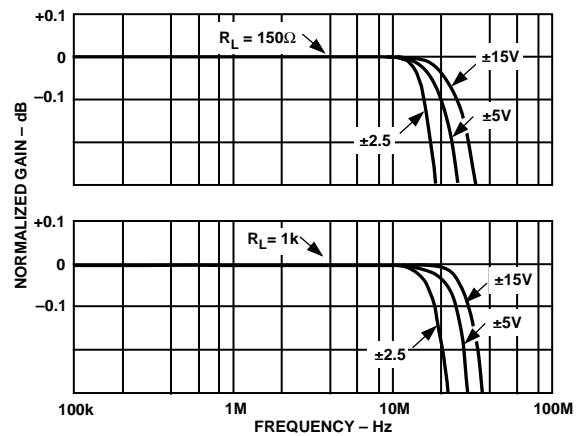

Figure 50. Fine-Scale Gain (Normalized) vs. Frequency for Various Supply Voltages, Gain = +2,  $R_F = 715 \Omega$

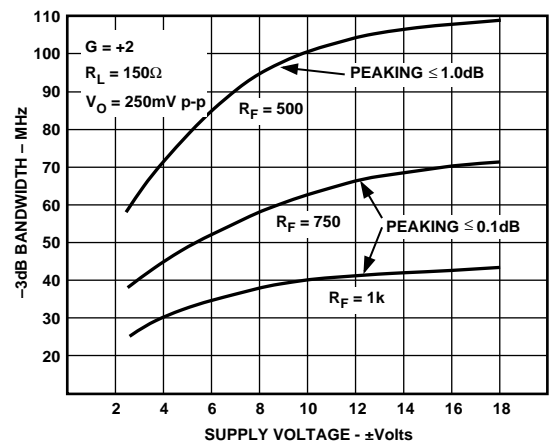

Figure 51. -3 dB Bandwidth vs. Supply Voltage, Gain = +2,  $R_L = 150 \Omega$

# AD810

## 2:1 VIDEO MULTIPLEXER

The outputs of two AD810s can be wired together to form a 2:1 mux without degrading the flatness of the gain response. Figure 54 shows a recommended configuration which results in  $-0.1$  dB bandwidth of 20 MHz and OFF channel isolation of 77 dB at 10 MHz on  $\pm 5$  V supplies. The time to switch between channels is about  $0.75 \mu\text{s}$  when the disable pins are driven by open drain output logic. Adding pull-up resistors to the logic outputs or using complementary output logic (such as the 74HC04) reduces the switching time to about 180 ns. The switching time is only slightly affected by the signal level.

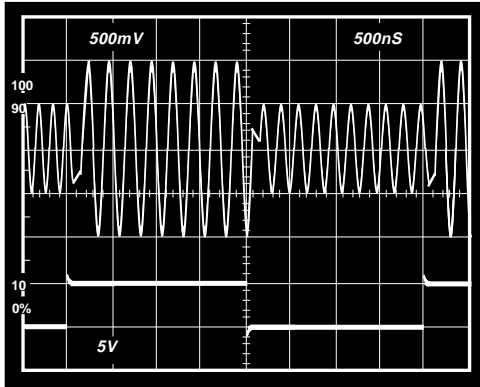

Figure 52. Channel Switching Time for the 2:1 Mux

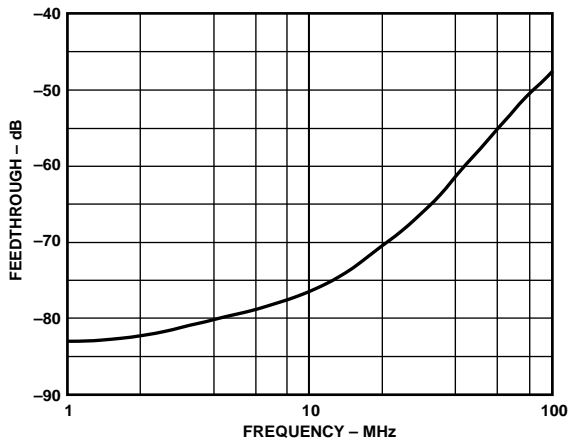

Figure 53. 2:1 Mux OFF Channel Feedthrough vs. Frequency

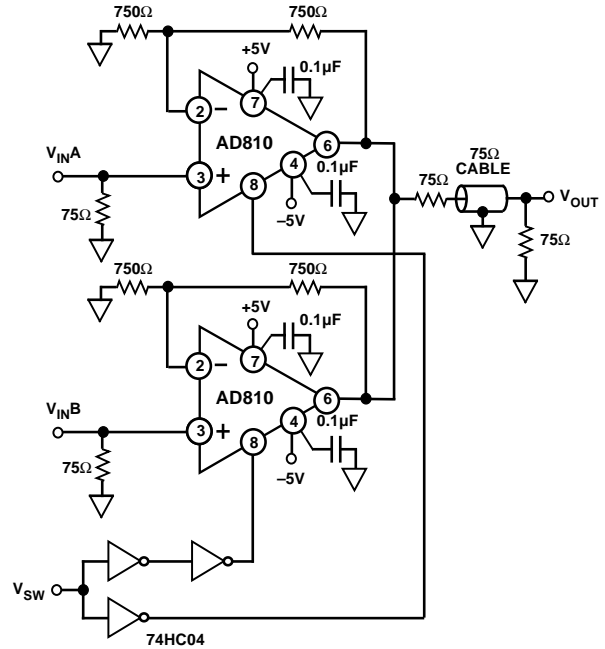

Figure 54. A Fast Switching 2:1 Video Mux

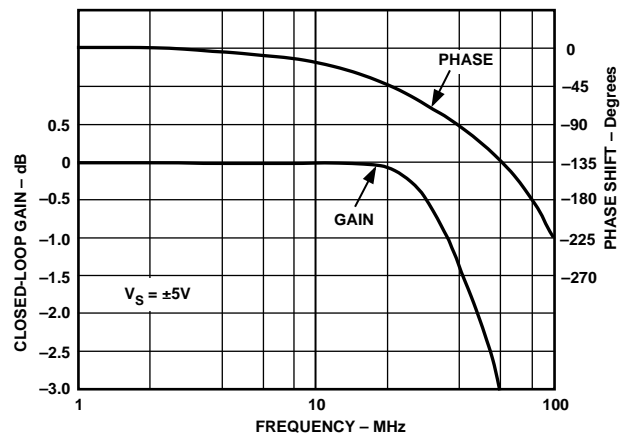

Figure 55. 2:1 Mux ON Channel Gain and Phase vs. Frequency

**N:1 MULTIPLEXER**

A multiplexer of arbitrary size can be formed by combining the desired number of AD810s together with the appropriate selection logic. The schematic in Figure 58 shows a recommendation for a 4:1 mux which may be useful for driving a high impedance such as the input to a video A/D converter (such as the AD773). The output series resistors effectively compensate for the combined output capacitance of the OFF channels plus the input capacitance of the A/D while maintaining wide bandwidth. In the case illustrated, the -0.1 dB bandwidth is about 20 MHz with no peaking. Switching time and OFF channel isolation (for the 4:1 mux) are about 250 ns and 60 dB at 10 MHz, respectively.

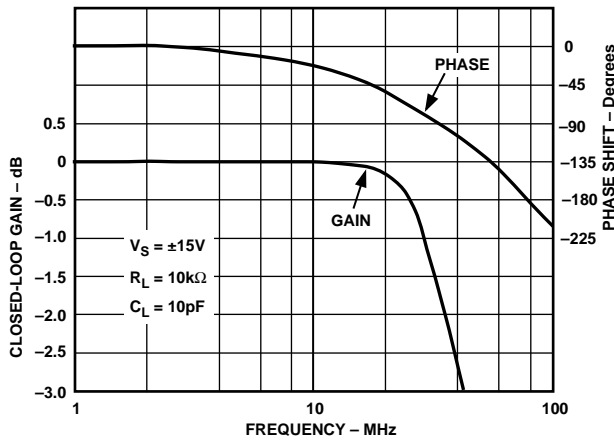

Figure 56. 4:1 Mux ON Channel Gain and Phase vs. Frequency

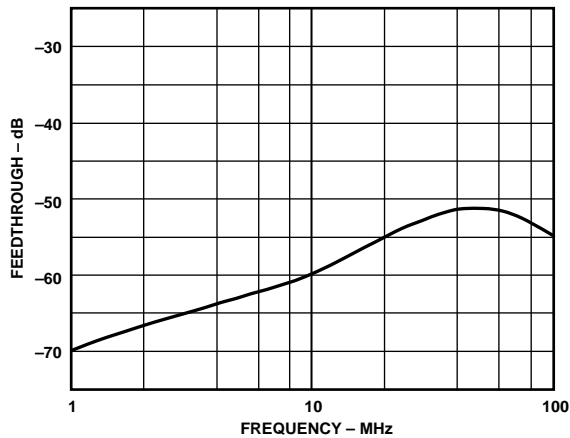

Figure 57. 4:1 Mux OFF Channel Feedthrough vs. Frequency

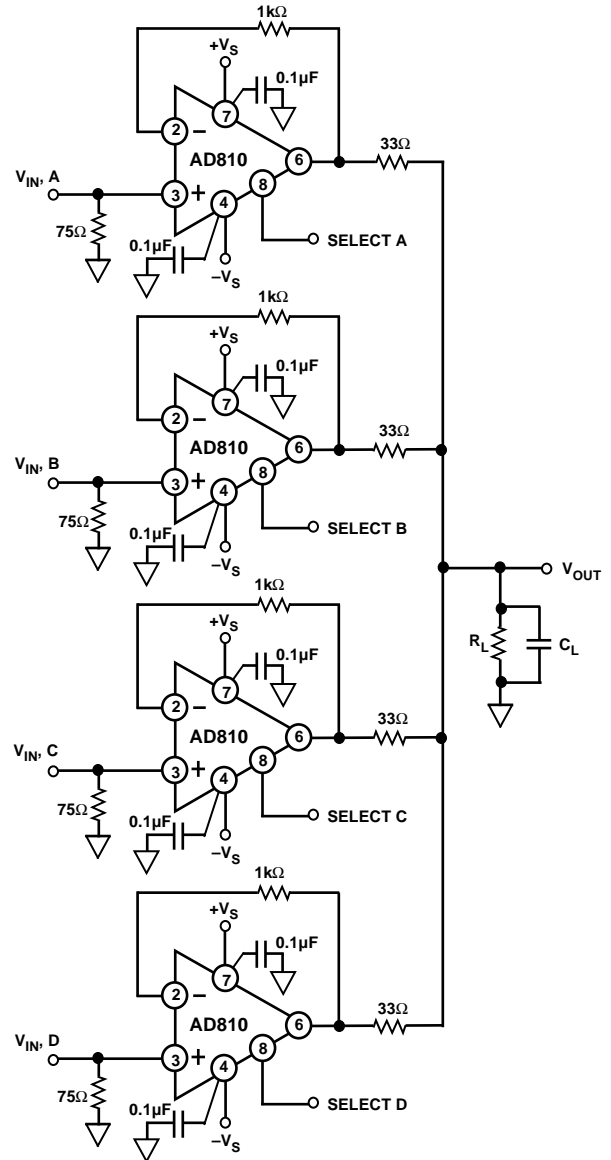
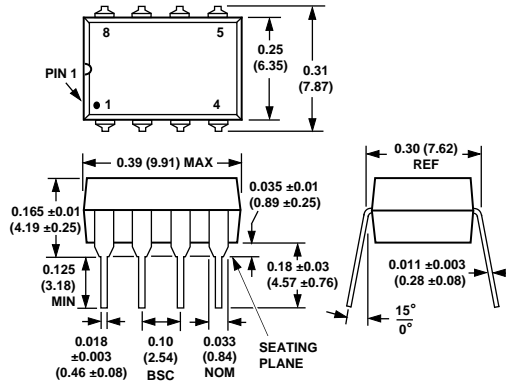

Figure 58. A 4:1 Multiplexer Driving a High Impedance

**OUTLINE DIMENSIONS**

Dimensions shown in inches and (mm).

**Plastic Mini-DIP (N) Package**



**Cerdip (Q) Package**

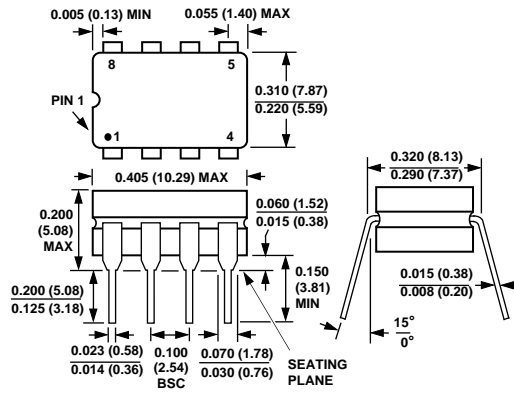

**8-Pin SOIC (R) Package**

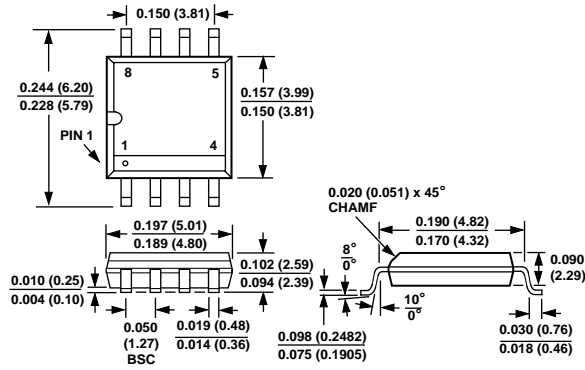

All brand or product names mentioned are trademarks or registered trademarks of their respective holders.



# Mouser Electronics

Authorized Distributor

Click to View Pricing, Inventory, Delivery & Lifecycle Information:

[Analog Devices Inc.:](#)

[AD810ARZ-REEL](#) [AD810ANZ](#) [5962-9313201MPA](#) [AD810AR](#) [AD810AN](#) [AD810ARZ-REEL7](#) [AD810ARZ](#)