

THIS DRAWING IS UNPUBLISHED. RELEASED FOR PUBLICATION
 © COPYRIGHT - By - ALL RIGHTS RESERVED.

LOC		DIST		REVISIONS			
P	LTR	DESCRIPTION		DATE	DWN	APVD	
AJ	16	N1	REVISED PER ECO-11-005030		11MAR11	RK	HMR

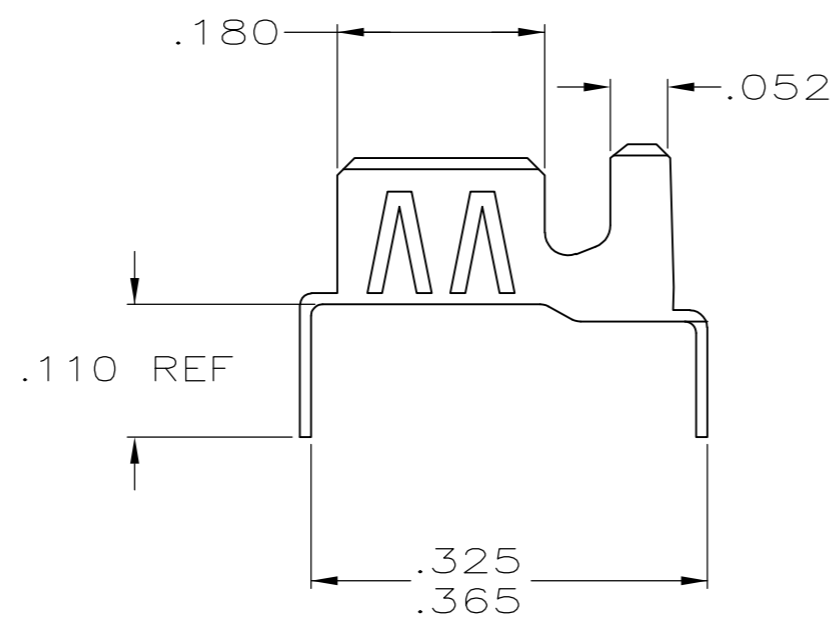
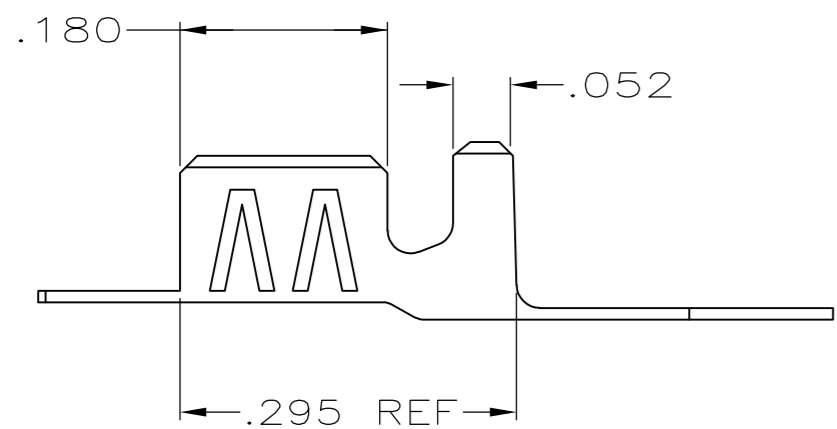
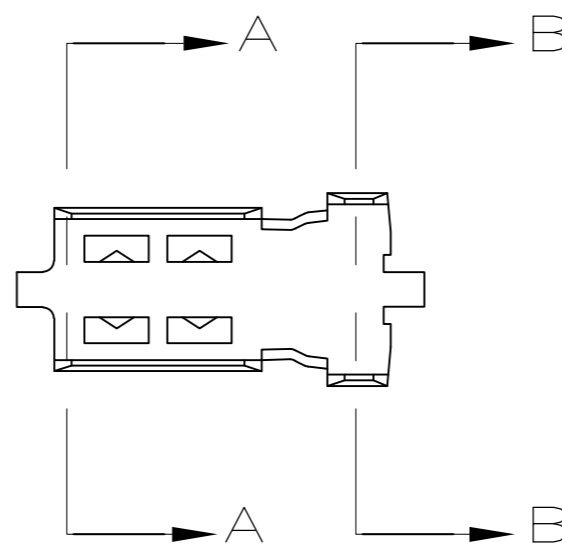
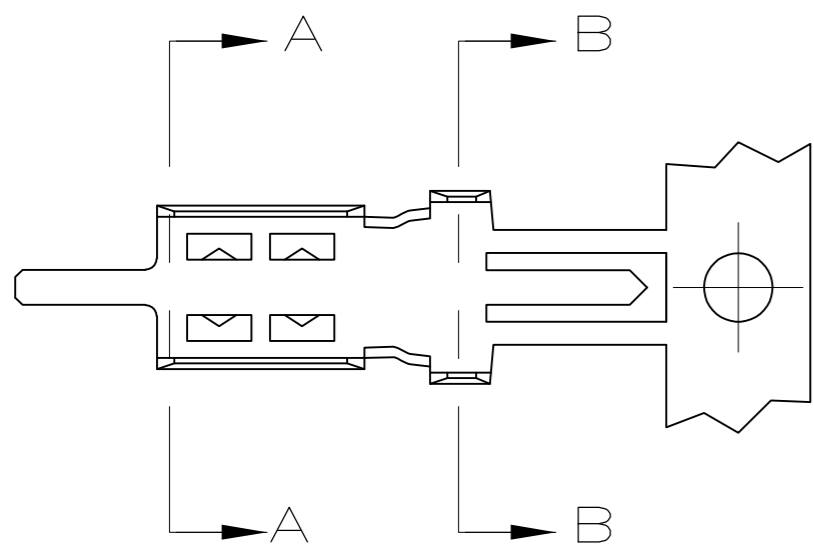

VIEW C

VIEW D

1. ACCEPTS COAX CABLE WITH .095-.110 O.D. JACKETS AND .055-.065 DIELECTRIC O.D. EXAMPLE: RG-174 AND RG-316
2. TIN PLATE PER ASTM-B-545.
3. INSTRUCTION SHEET NO.: 408-2472-2.
4. ON STRIP
5. ON STRIP, LEGS MUST BE BENT MANUALLY AFTER CRIMPING.
6. LOOSE PIECE PARTS WITH PREFORMED LEGS.
7. BRASS PER ASTM-B-36.
8. TIN-LEAD PLATE PER ASTM-B-545.

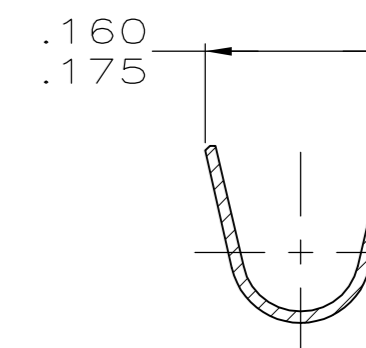
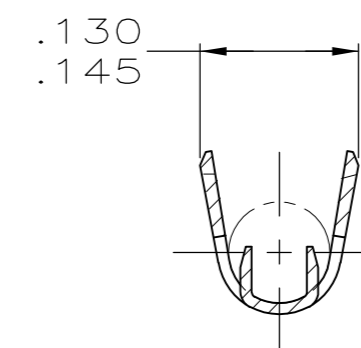

SECTION A-A

SECTION B-B

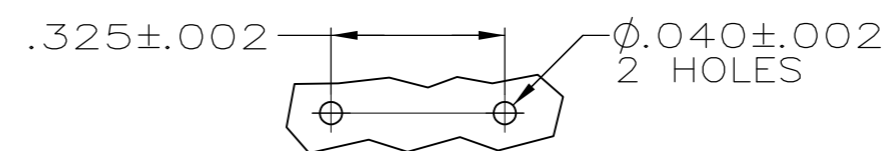

PCB LAYOUT

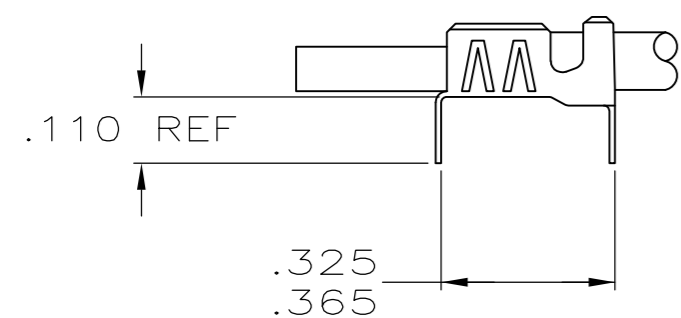

AS APPLIED BY APPLICATOR

VIEW E

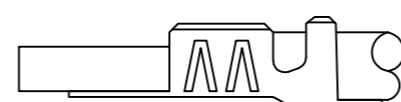

AS APPLIED BY APPLICATOR

VIEW F

2	D	6	9-226176-2
2	C&F	5	9-226176-1
2	C&E	4	9-226176-0
8	D	6	226176-4
8	C&F	5	226176-3
8	C&E	4	226176-2
FINISH	VIEW	TYPE	PART NUMBER

THIS DRAWING IS A CONTROLLED DOCUMENT.		DWN M. OBRINE 30JUN99	TE Connectivity	
DIMENSIONS: INCHES		CHK M. OBRINE 30JUN99		
TOLERANCES UNLESS OTHERWISE SPECIFIED:		APVD J. CABARLO 30JUN99	NAME	
0 PLC ± -		PRODUCT SPEC	BRAID-PIC	
1 PLC ± -		APPLICATION SPEC	P.C. BOARD GROUND TERMINAL	
2 PLC ± -			SINGLE CRIMP-SINGLE CONTACT	
3 PLC ± .008			SIZE	CAGE CODE
4 PLC ± -			A2	00779
ANGLES ± -		WEIGHT	DRAWING NO	
FINISH		.007 OZ	C=226176	
SEE NOTE 7		CUSTOMER DRAWING	SCALE	SHEET
			6:1	1 of 1
			REV	N1

Mouser Electronics

Authorized Distributor

Click to View Pricing, Inventory, Delivery & Lifecycle Information:

[TE Connectivity:](#)

[9-226176-2](#)