



---

## 14-Bit 125-MSPS Analog-to-Digital Converter

---

### FEATURES

- 14-Bit Resolution
- 125-MSPS Sample Rate
- High Signal-to-Noise Ratio (SNR):  
70.5 dBFS at 100 MHz  $f_{IN}$  (TYP)
- High Spurious-Free Dynamic Range (SFDR):  
82 dBc at 100-MHz  $f_{IN}$  (TYP)
- 2.3-V<sub>PP</sub> Differential Input Voltage
- Internal Voltage Reference
- 3.3-V Single-Supply Voltage
- Analog Power Dissipation: 578 mW  
– Total Power Dissipation: 780 mW
- Serial Programming Interface
- TQFP-64 PowerPAD™ Package

- One Assembly/Test Site
- One Fabrication Site
- Available in Military (–55°C/125°C)  
Temperature Range<sup>(1)</sup>
- Extended Product Life Cycle
- Extended Product-Change Notification
- Product Traceability

### APPLICATIONS

- Wireless Communication
- Test and Measurement Instrumentation
- Single and Multichannel Digital Receivers
- Communication Instrumentation  
– Radar, Infrared
- Video and Imaging

### SUPPORTS DEFENSE, AEROSPACE, AND MEDICAL APPLICATIONS

- Controlled Baseline

<sup>(1)</sup> Custom temperature ranges available.

### DESCRIPTION

The ADS5500 is a high-performance, 14-bit 125-MSPS analog-to-digital converter (ADC). To provide a complete converter solution, it includes a high-bandwidth linear sample-and-hold stage (S&H) and internal reference. Designed for applications demanding the highest speed and highest dynamic performance in a small space, the ADS5500 has excellent power consumption of 780 mW at 3.3-V single-supply voltage. This allows an even higher system integration density. The provided internal reference simplifies system design requirements. A parallel CMOS-compatible output ensures seamless interfacing with common logic.

The ADS5500 is available in a 64-pin TQFP PowerPAD package and is specified over the full temperature range of –55°C to 125°C.



Please be aware that an important notice concerning availability, standard warranty, and use in critical applications of Texas Instruments semiconductor products and disclaimers thereto appears at the end of this data sheet.

PowerPAD is a trademark of Texas Instruments.

PRODUCTION DATA information is current as of publication date. Products conform to specifications per the terms of Texas Instruments standard warranty. Production processing does not necessarily include testing of all parameters.

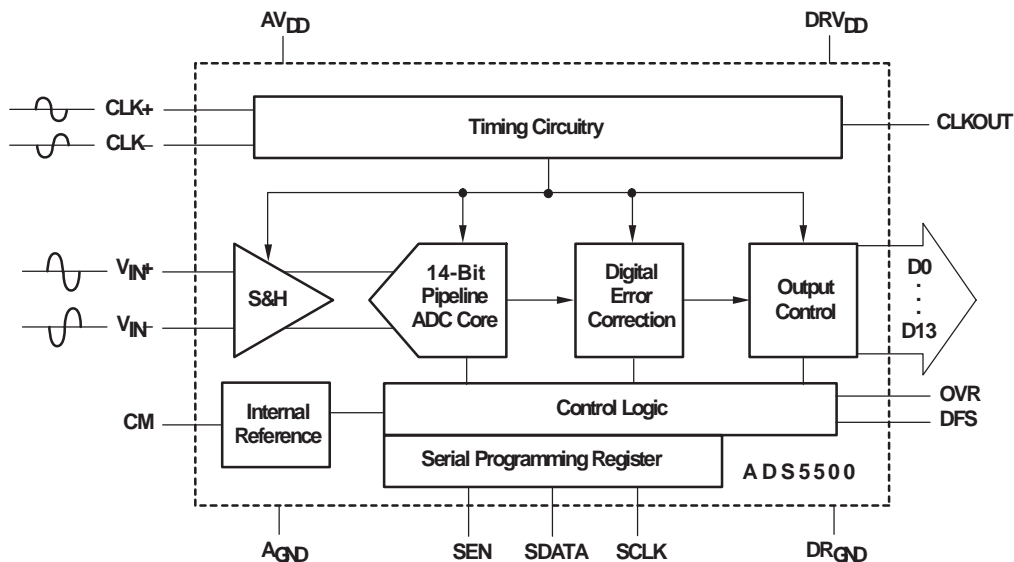

**PACKAGE/ORDERING INFORMATION(1)**

PRODUCT	PACKAGE LEAD	PACKAGE DESIGNATOR	SPECIFIED TEMPERATURE RANGE	PACKAGE MARKING	ORDERING NUMBER	TRANSPORT MEDIA, QUANTITY
ADS5500-EP	HTQFP-64(2) PowerPAD	PAP	-55°C to 125°C	ADS5500M	ADS5500MPAPEP	Tray, 160
					ADS5500MPAPREP	Tape and Reel, 1000

(1) For the most current product and ordering information, see the Package Option Addendum located at the end of this data sheet.

(2) Thermal pad size: 3,5 mm x 3,5 mm (min), 4 mm x 4 mm (max).

## ABSOLUTE MAXIMUM RATINGS(1)

over operating free-air temperature range (unless otherwise noted)

		ADS5500-EP	UNIT
Supply Voltage	AVDD to AGND, DRVDD to DRGND	-0.3 to +3.7	V
	AGND to DRGND	±0.1	V
Analog input to AGND		-0.15 to +2.5	V
Logic input to DRGND		-0.3 to DRVDD + 0.3	V
Digital data output to DRGND		-0.3 to DRVDD + 0.3	V
Input current (any input)		30	mA
Operating temperature range		-55 to +125	°C
Junction temperature		+142	°C
Storage temperature range		-65 to +150	°C

- (1) Stresses above these ratings may cause permanent damage. Exposure to absolute maximum conditions for extended periods may degrade device reliability. These are stress ratings only, and functional operation of the device at these or any other conditions beyond those specified is not implied.

## TQFP-64 PowerPAD™ Package Thermal Characteristics

PARAMETER	SAME PACKAGE FORM WITHOUT PowerPAD	PowerPAD NOT CONNECTED TO PCB THERMAL PLAN	PowerPAD CONNECTED TO PCB THERMAL PLANE(2)
Thermal resistance, junction to ambient (see (1) and (2)), RTJA	75.83°C/W	42.2°C/W	21.47°C/W
Thermal resistance, junction to case (see (1) and (2)), RTJC	7.8°C/W	0.38°C/W	0.38°C/W

- (1) Specified with the PowerPAD bond pad on the backside of the package soldered to a 2-oz Cu plate PCB thermal plane.  
(2) Airflow is at 0 LFM (no airflow)



This integrated circuit can be damaged by ESD. Texas Instruments recommends that all integrated circuits be handled with appropriate precautions. Failure to observe proper handling and installation procedures can cause damage.

ESD damage can range from subtle performance degradation to complete device failure. Precision integrated circuits may be more susceptible to damage because small parametric changes could cause the device not to meet its published specifications.

## RECOMMENDED OPERATING CONDITIONS

PARAMETER	MIN	TYP	MAX	UNIT
<b>Supplies</b>				
Analog supply voltage, AVDD	3	3.3	3.6	V
Output driver supply voltage, DRVDD	3	3.3	3.6	V
<b>Analog Input</b>				
Differential input range	2.3			V <sub>PP</sub>
Input common-mode voltage, V <sub>CM</sub> (1)	1.5		1.6	V
<b>Digital Output</b>				
Maximum output load	10			pF
<b>Clock Input</b>				
ADCLK input sample rate (sine wave) 1/t <sub>C</sub>	DLL ON	60	125	MSPS
	DLL OFF	10	80	
Clock amplitude, sine wave, differential(2)	3			V <sub>PP</sub>
Clock duty cycle(3)	50%			
Open free-air temperature	-55		125	°C

- (1) Input common-mode should be connected to CM.  
(2) See Figure 14 for more information.  
(3) See Figure 13 for more information.

Long-term high-temperature storage and/or extended use at maximum recommended operating conditions may result in a reduction of overall device life. See Figure 1 for additional information on thermal derating.

Electromigration failure mode applies to powered part; Kirkendall voiding failure mode is a function of temperature only.

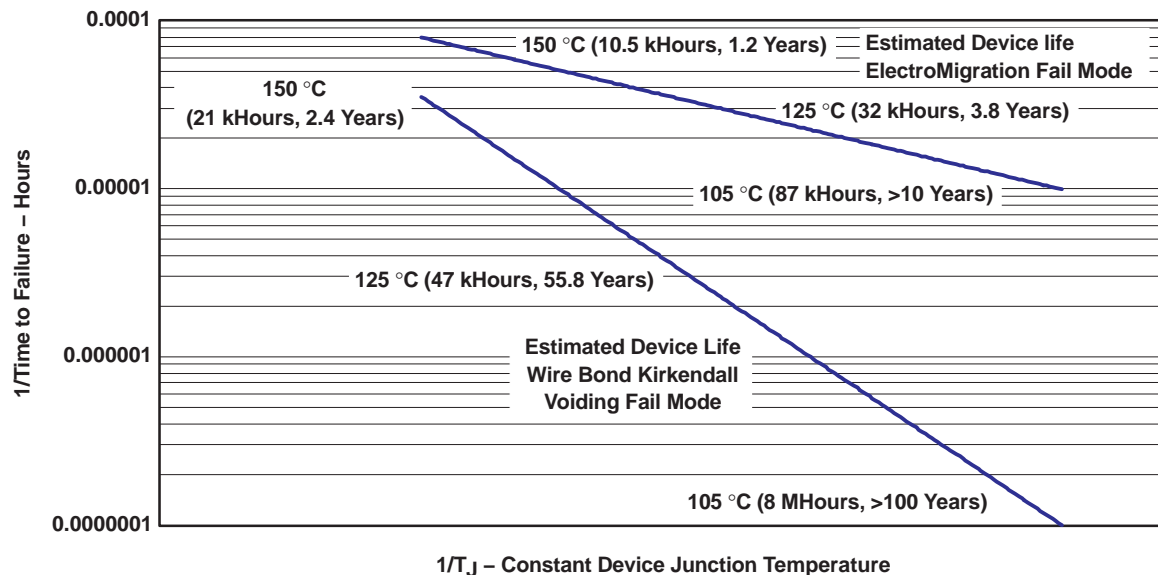

Figure 1. Time-to-Failure vs Junction Temperature

**ELECTRICAL CHARACTERISTICS**

 Typ, min, and max values at  $T_A = 25^\circ\text{C}$ , full temperature range is  $T_{\text{MIN}} = -55^\circ\text{C}$  to  $T_{\text{MAX}} = 125^\circ\text{C}$ , sampling rate = 125 MSPS, 50% clock duty cycle,  $AV_{\text{DD}} = DRV_{\text{DD}} = 3.3\text{ V}$ , DLL On,  $-1\text{-dBFS}$  differential input, and  $3\text{-V}_{\text{pp}}$  differential clock (unless otherwise noted)

PARAMETER	CONDITIONS		MIN	TYP	MAX	UNIT
<b>Resolution</b>				14 Tested		Bits
<b>Analog Inputs</b>						
Differential input range				2.3		$V_{\text{pp}}$
Differential input impedance	See Figure 5			6.6		$k\Omega$
Differential input capacitance	See Figure 5			4		pF
Total analog input common-mode current				4(1)		mA
Analog input bandwidth	Source impedance = $50\ \Omega$			750		MHz
<b>Conversion Characteristics</b>						
Maximum sample rate			See note (2)		125	MSPS
Data latency	See timing diagram, See Figure 2			16.5		Clock Cycles
<b>Internal Reference Voltages</b>						
Reference bottom voltage, $V_{\text{REFM}}$				0.97		V
Reference top voltage, $V_{\text{REFP}}$				2.11		V
Reference error	Room temp		-4%		4%	
	Full temp range		-5%		5%	
Common-mode voltage output, $V_{\text{CM}}$				$1.55 \pm 0.05$		V
<b>Dynamic DC Characteristics and Accuracy</b>						
No missing codes				Tested		
Differential linearity error, DNL	$f_{\text{IN}} = 10\text{ MHz}$		-0.9	$\pm 0.75$	1.1	LSB
Integral linearity error, INL	$f_{\text{IN}} = 10\text{ MHz}$	Room temp	-5		5	LSB
		Full temp range	-8		8	
Offset error				$\pm 1.5$		mV
Offset temperature coefficient				0.0007		$\%/\text{C}$
Gain error				$\pm 0.45$		$\% \text{FS}$
Gain temperature coefficient				0.01		$\Delta\%/\text{C}$
<b>Dynamic AC Characteristics</b>						
Signal-to-noise ratio (SNR)	$f_{\text{IN}} = 10\text{ MHz}$	Room temp	70.5	71.5		dBFS
		Full temp range	68	71.5		
	$f_{\text{IN}} = 30\text{ MHz}$			71.5		
	$f_{\text{IN}} = 55\text{ MHz}$			71.5		
	$f_{\text{IN}} = 70\text{ MHz}$	Room temp	70	71.2		
		Full temp range	66.5	71		
	$f_{\text{IN}} = 100\text{ MHz}$			70.5		
	$f_{\text{IN}} = 150\text{ MHz}$			70.1		
$f_{\text{IN}} = 225\text{ MHz}$			69.1			
RMS output noise	Input tied to common-mode			1.1		LSB
Spurious-free dynamic range (SFDR)	$f_{\text{IN}} = 10\text{ MHz}$	Room temp	82	84		dBc
		Full temp range	76	84		
	$f_{\text{IN}} = 30\text{ MHz}$			84		
	$f_{\text{IN}} = 55\text{ MHz}$			79		
	$f_{\text{IN}} = 70\text{ MHz}$	Room temp	80	83		
		Full temp range	75	82		
	$f_{\text{IN}} = 100\text{ MHz}$			82		
	$f_{\text{IN}} = 150\text{ MHz}$			78		
$f_{\text{IN}} = 225\text{ MHz}$			74			

(1) 2-mA per input

 (2) See *Recommended Operating Conditions*.

**ELECTRICAL CHARACTERISTICS(continued)**

Typ, min, and max values at  $T_A = 25^\circ\text{C}$ , full temperature range is  $T_{\text{MIN}} = -55^\circ\text{C}$  to  $T_{\text{MAX}} = 125^\circ\text{C}$ , sampling rate = 125 MSPS, 50% clock duty cycle,  $AV_{\text{DD}} = DRV_{\text{DD}} = 3.3\text{ V}$ , DLL On, -1-dBFS differential input, and 3-V<sub>pp</sub> differential clock (unless otherwise noted)

PARAMETER	CONDITIONS		MIN	TYP	MAX	UNIT
Second-harmonic (HD2)	f <sub>IN</sub> = 10 MHz	Room temp	82	91		dBc
		Full temp range	77	86		
	f <sub>IN</sub> = 30 MHz			86		
	f <sub>IN</sub> = 55 MHz			84		
	f <sub>IN</sub> = 70 MHz	Room temp	80	87		
		Full temp range	75	83		
	f <sub>IN</sub> = 100 MHz			84		
	f <sub>IN</sub> = 150 MHz			78		
f <sub>IN</sub> = 225 MHz			74			
Third harmonic (HD3)	f <sub>IN</sub> = 10 MHz	Room temp	82	89		dBc
		Full temp range	77	88		
	f <sub>IN</sub> = 30 MHz			90		
	f <sub>IN</sub> = 55 MHz			79		
	f <sub>IN</sub> = 70 MHz	Room temp	80	85		
		Full temp range	75	82		
	f <sub>IN</sub> = 100 MHz			82		
	f <sub>IN</sub> = 150 MHz			80		
f <sub>IN</sub> = 225 MHz			76			
Worst-harmonic/spur (other than HD2 and HD3)	f <sub>IN</sub> = 10 MHz	Room temp		88		dBc
	f <sub>IN</sub> = 70 MHz	Room temp		86		
Signal-to-noise + distortion (SINAD)	f <sub>IN</sub> = 10 MHz	Room temp	69	70		dBc
		Full temp range	66.5	70		
	f <sub>IN</sub> = 30 MHz			70		
	f <sub>IN</sub> = 55 MHz			69.5		
	f <sub>IN</sub> = 70 MHz	Room temp	68.5	69		
		Full temp range	65	69.5		
	f <sub>IN</sub> = 100 MHz			69		
	f <sub>IN</sub> = 150 MHz			69		
f <sub>IN</sub> = 225 MHz			66.4			
Total harmonic distortion (THD)	f <sub>IN</sub> = 10 MHz	Room temp	80	85		dBc
		Full temp range	76	83		
	f <sub>IN</sub> = 30 MHz			82		
	f <sub>IN</sub> = 55 MHz			77		
	f <sub>IN</sub> = 70 MHz	Room temp	77.5	81		
		Full temp range	74	79.5		
	f <sub>IN</sub> = 100 MHz			79		
	f <sub>IN</sub> = 150 MHz			75		
f <sub>IN</sub> = 225 MHz			71.8			

**ELECTRICAL CHARACTERISTICS(continued)**

Typ, min, and max values at  $T_A = 25^\circ\text{C}$ , full temperature range is  $T_{\text{MIN}} = -55^\circ\text{C}$  to  $T_{\text{MAX}} = 125^\circ\text{C}$ , sampling rate = 125 MSPS, 50% clock duty cycle,  $AV_{\text{DD}} = DRV_{\text{DD}} = 3.3\text{ V}$ , DLL On,  $-1\text{ dBFS}$  differential input, and  $3\text{-V}_{\text{pp}}$  differential clock (unless otherwise noted)

PARAMETER	CONDITIONS	MIN	TYP	MAX	UNIT
Effective number of bits (ENOB)	$f_{\text{IN}} = 70\text{ MHz}$		11.3		Bits
Two-tone intermodulation distortion (IMD)	$f = 10.1\text{ MHz}, 15.1\text{ MHz}$ ( $-7\text{ dBFS}$ each tone)		85		dBc
	$f = 30.1\text{ MHz}, 35.1\text{ MHz}$ ( $-7\text{ dBFS}$ each tone)		85		
	$f = 50.1\text{ MHz}, 55.1\text{ MHz}$ ( $-7\text{ dBFS}$ each tone)		88		
<b>Power Supply</b>					
Total supply current, $I_{\text{CC}}$	$V_{\text{IN}} = \text{full-scale}, f_{\text{IN}} = 5.5\text{ MHz},$ $AV_{\text{DD}} = DRV_{\text{DD}} = 3.3\text{ V}$		236	265	mA
Analog supply current, $I_{\text{AVDD}}$	$V_{\text{IN}} = \text{full-scale}, f_{\text{IN}} = 5.5\text{ MHz},$ $AV_{\text{DD}} = DRV_{\text{DD}} = 3.3\text{ V}$		175	190	mA
Output buffer supply current, $I_{\text{DRVDD}}$	$V_{\text{IN}} = \text{full-scale}, f_{\text{IN}} = 55\text{ MHz},$ $AV_{\text{DD}} = DRV_{\text{DD}} = 3.3\text{ V}$		61	75	mA
Power dissipation	Analog only		578	627	mW
	Total power with $10\text{-pF}$ load on digital output to ground		780	875	mW
Standby power	With clocks running		181	250	mW

**DIGITAL CHARACTERISTICS**

Typ, min, and max values at  $T_A = 25^\circ\text{C}$ , full temperature range is  $T_{\text{MIN}} = -55^\circ\text{C}$  to  $T_{\text{MAX}} = 125^\circ\text{C}$ , sampling rate = 125 MSPS, 50% clock duty cycle,  $AV_{\text{DD}} = DRV_{\text{DD}} = 3.3\text{ V}$ , DLL On,  $-1\text{ dBFS}$  differential input, and  $3\text{-V}_{\text{pp}}$  differential clock (unless otherwise noted)

PARAMETER	CONDITIONS	MIN	TYP	MAX	UNIT
<b>Digital Inputs</b>					
High-level input voltage		2.4			V
Low-level input voltage				0.8	V
High-level input current				10	$\mu\text{A}$
Low-level input current				10	$\mu\text{A}$
Input current for RESET			-20		$\mu\text{A}$
Input capacitance			4		pF
<b>Digital Outputs<sup>(1)</sup></b>					
Low-level output voltage	$C_{\text{LOAD}} = 10\text{ pF}^{(2)}, f_{\text{S}} = 125\text{ MSPS}$		0.3		V
High-level output voltage	$C_{\text{LOAD}} = 10\text{ pF}^{(2)}, f_{\text{S}} = 125\text{ MSPS}$		3		V
Output capacitance			3		pF

(1) For optimal performance, all digital output lines (D0:D13), including the output clock, should see a similar load.

(2) Equivalent capacitance to ground of (load + parasitics of transmission lines)

**TIMING CHARACTERISTICS**

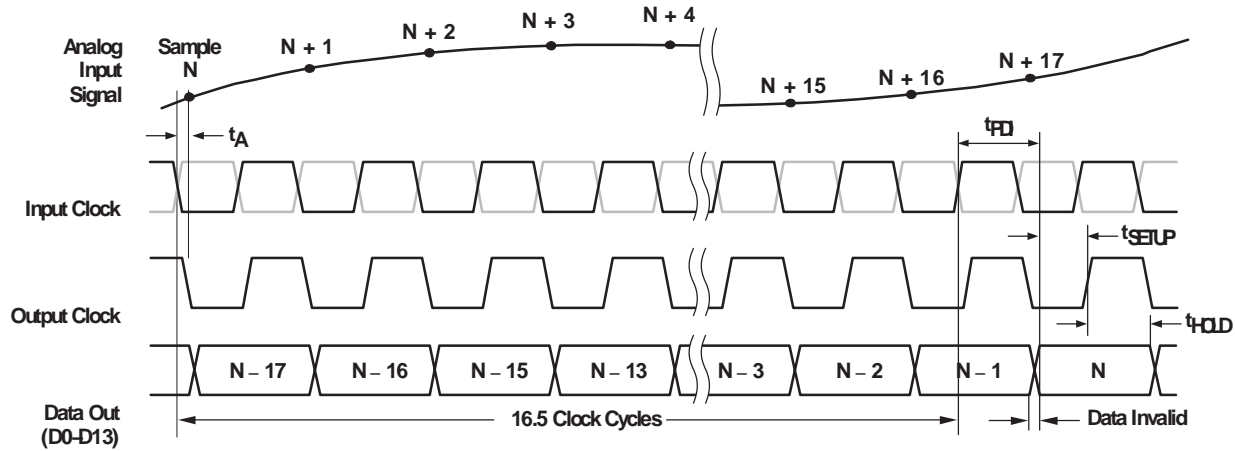

NOTE: It is recommended that the loading at CLKOUT and all data lines are accurately matched to ensure that the above timing matches closely with the specified values.

**Figure 2. Timing Diagram**

**TIMING CHARACTERISTICS (1)**

Typ, min, and max values at  $T_A = 25^\circ\text{C}$ , min and max specified over the full recommended operating temperature range,  $AV_{DD} = DRV_{DD} = 3.3\text{ V}$ , 3-V<sub>pp</sub> differential clock, and  $C_{LOAD} = 10\text{ pF}$  (unless otherwise noted)

PARAMETER	DESCRIPTION	TYP	UNIT
<b>Switching Specification</b>			
Aperture delay, $t_A$	Input CLK falling edge to data sampling point	1	ns
Aperture jitter (uncertainty)	Uncertainty in sampling instant	300	fs
Data setup time, $t_{SU}$	Data valid <sup>(2)</sup> to 50% of CLKOUT rising edge	2.5	ns
Data hold time, $t_H$	50% of CLKOUT rising edge to data becoming invalid <sup>(2)</sup>	2.1	ns
Input clock to output data valid start <sup>(3)(4)</sup> , $t_{START}$	Input clock rising edge to Data valid start delay	2.2	ns
Input clock to output data valid end <sup>(3)(4)</sup> , $t_{END}$	Input clock rising edge to Data valid end delay	6.9	ns
Output clock jitter, $t_{JIT}$	Uncertainty in CLKOUT rising edge, peak-to-peak	150	ps
Output clock rise time, $t_r$	Rise time of CLKOUT measured from 20% to 80% of DRVDD	1.7	ns
Output clock fall time, $t_f$	Fall time of CLKOUT measured from 80% to 20% of DRVDD	1.5	ns
Input clock to output clock delay, $t_{PDI}$	Input clock rising edge, zero crossing, to output clock rising edge 50%	4.8	ns
Data rise time, $t_r$	Data rise time measured from 20% to 80% of DRVDD	3.6	ns
Data fall time, $t_f$	Data fall time measured from 80% to 20% of DRVDD	2.8	ns
Latency Time for a sample to propagate to the ADC outputs 17.5 clock cycles		17.5	Clock Cycles

(1) Timing parameters are ensured by design and characterization and not tested in production.

(2) Data valid refers to 2 V for LOGIC high and 0.8 V for LOGIC low.

(2) See the *Output Information* section for details on using the input clock for data capture.

(4) These specifications apply when the CLKOUT polarity is set to rising edge (according to Table 3). Add one-half clock period for the valid number for a falling-edge CLKOUT polarity.



## RESET TIMING CHARACTERISTICS

Typ, min, and max values at  $T_A = 25^\circ\text{C}$ , min and max specified over the full recommended operating temperature range,  $AV_{DD} = DRV_{DD} = 3.3\text{ V}$ ,  $3-V_{PP}$  differential clock (unless otherwise noted)

PARAMETER	DESCRIPTION	TYP	UNIT
<b>Switching Specification</b>			
Power-up time	Delay from power-up of $AV_{DD}$ and $DRV_{DD}$ to output stable	40	ms

## SERIAL PROGRAMMING INTERFACE CHARACTERISTICS

The device has a three-wire serial interface. The device latches the serial data  $SDATA$  on the falling edge of serial clock  $SCLK$  when  $SEN$  is active.

- Serial shift of bits is enabled when  $SEN$  is low.  $SCLK$  shifts serial data at falling edge.
- Minimum width of data stream for a valid loading is 16 clocks.
- Data is loaded at every 16th  $SCLK$  falling edge while  $SEN$  is low.
- In case the word length exceeds a multiple of 16 bits, the excess bits are ignored.
- Data can be loaded in multiple of 16-bit words within a single active  $SEN$  pulse.

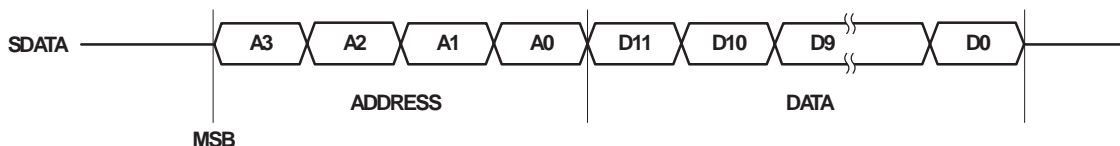

Figure 3. DATA Communication Is 2 Byte, MSB First

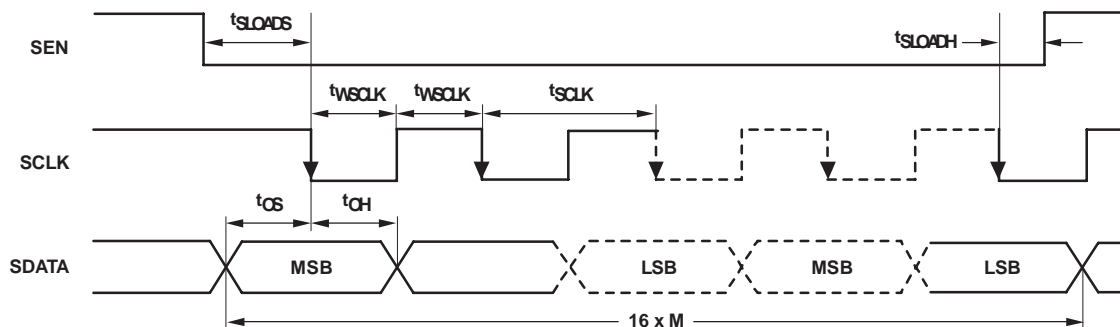

Figure 4. Serial Programming Interface Timing Diagram

Table 1. Serial Programming Interface Timing Characteristics

SYMBOL	PARAMETER	MIN(1)	TYP(1)	MAX(1)	UNIT
$t_{SCLK}$	$SCLK$ period	50			ns
$t_{WSCLK}$	$SCLK$ duty cycle	25%	50%	75%	
$t_{LOADS}$	$SEN$ to $SCLK$ setup time	8			ns
$t_{SLOADH}$	$SCLK$ to $SEN$ hold time	6			ns
$t_{DS}$	Data setup time	8			ns
$t_{DH}$	Data hold time	6			ns

(1) Min, typ, and max values are characterized, but not production tested.

**Table 2. Serial Register Table**

A3	A2	A1	A0	D11	D10	D9	D8	D7	D6	D5	D4	D3	D2	D1	D0	DESCRIPTION
1	1	0	1	0	0	0	0	0	0	0	0	0	0	DLL OFF	0	DLL OFF = 0: Internal DLL is on, recommended for 60–125 MSPS clock speed DLL OFF = 1: Internal DLL is off, recommended for 10–80 MSPS clock speed
1	1	1	0	0	TP<1>	TP<0>	0	0	0	0	0	0	0	0	0	TP<1:0>: Test modes for output data capture TP<1> = 0, TP<0> = 0: Normal mode of operation, TP<1> = 0 TP<0> = 1: All output lines are pulled to '0', TP<1> = 1 TP<0> = 0: All output lines are pulled to '1', TP<1> = 1 TP<0> = 1: A continuous stream of '10' comes out on all output lines
1	1	1	1	PDN	0	0	0	0	0	0	0	0	0	0	0	PDN = 0: Normal mode of operation, PDN = 1: Device is put in power down (low current) mode

**Table 3. DATA FORMAT SELECT (DFS TABLE)**

DFS-PIN VOLTAGE ( $V_{DFS}$ )	DATA FORMAT	CLOCK OUTPUT POLARITY
$V_{DFS} < \frac{1}{6} \times AV_{DD}$	Straight binary	Data valid on rising edge
$\frac{5}{12} \times AV_{DD} > V_{DFS} > \frac{1}{3} \times AV_{DD}$	Twos complement	Data valid on rising edge
$\frac{2}{3} \times AV_{DD} > V_{DFS} > \frac{7}{12} \times AV_{DD}$	Straight binary	Data valid on falling edge
$V_{DFS} > \frac{5}{6} \times AV_{DD}$	Twos complement	Data valid on falling edge

**PIN CONFIGURATION**

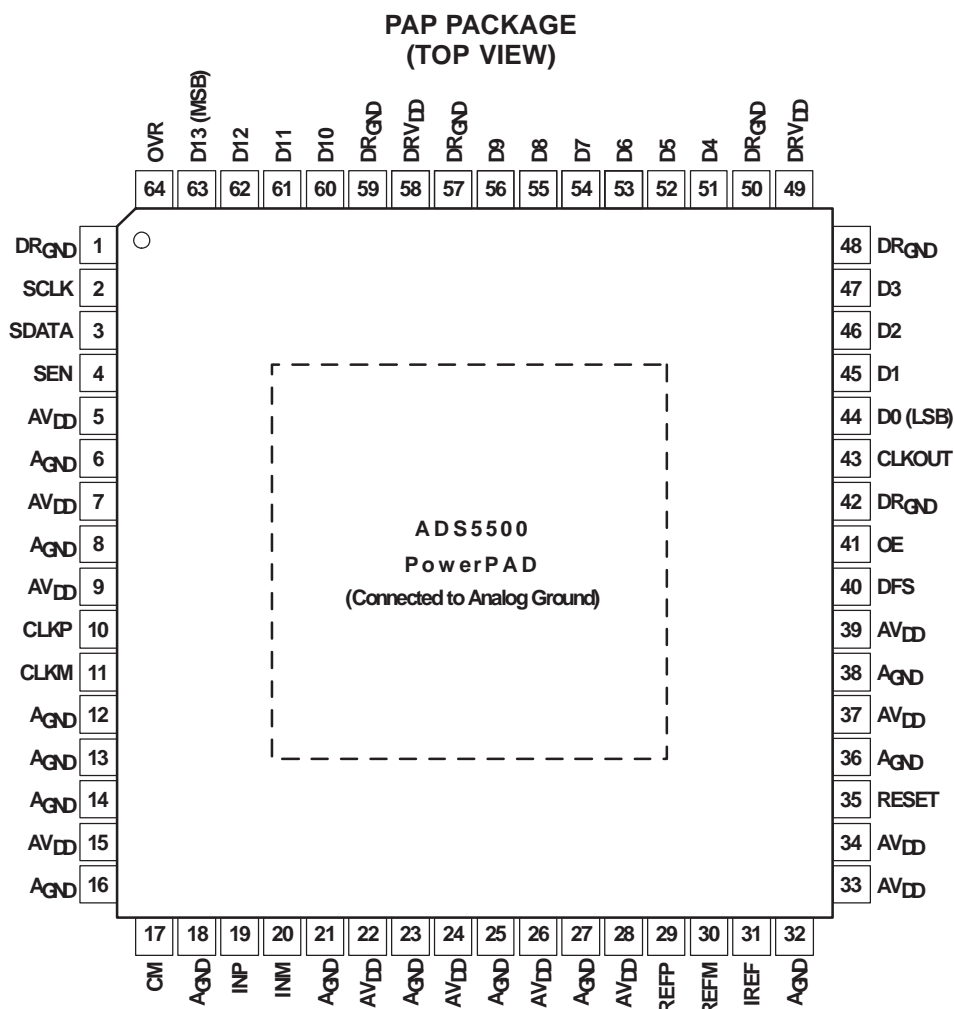

**PIN ASSIGNMENTS**

NAME	TERMINAL		NO. OF PINS	I/O	DESCRIPTION
	NO.				
AV <sub>DD</sub>	5, 7, 9, 15, 22, 24, 26, 28, 33, 34, 37, 39		12	I	Analog power supply
AGND	6, 8, 12, 13, 14, 16, 18, 21, 23, 25, 27, 32, 36, 38		14	I	Analog ground
DRV <sub>DD</sub>	49, 58		2	I	Output driver power supply
DR <sub>GND</sub>	1, 42, 48, 50, 57, 59		6	I	Output driver ground
INP	19		1	I	Differential analog input (positive)
INM	20		1	I	Differential analog input (negative)
REFP	29		1	O	Reference voltage (positive), 0.1- $\mu$ F capacitor in series with a 1- $\Omega$ resistor to GND
REFM	30		1	O	Reference voltage (negative), 0.1- $\mu$ F capacitor in series with a 1- $\Omega$ resistor to GND
IREF	31		1	I	Current set, 56-k $\Omega$ resistor to GND, do not connect capacitors
CM	17		1	O	Common-mode output voltage
RESET	35		1	I	Reset (active high), 200-k $\Omega$ resistor to AV <sub>DD</sub>
OE	41		1	I	Output enable (active high)
DFS	40		1	I	Data format and clock out polarity select <sup>(1)</sup>
CLKP	10		1	I	Data converter differential input clock (positive)
CLKM	11		1	I	Data converter differential input clock (negative)
SEN	4		1	I	Serial interface chip select
SDATA	3		1	I	Serial interface data
SCLK	2		1	I	Serial interface clock
D0 (LSB)–D13 (MSB)	44–47, 51–56, 60–63		14	O	Parallel data output
OVR	64		1	O	Over-range indicator bit
CLKOUT	43		1	O	CMOS clock out in sync with data

NOTE: PowerPAD is connected to analog ground.

(1) The DFS pin is programmable to four discrete voltage levels: 0,  $3/8$  AV<sub>DD</sub>,  $5/8$  AV<sub>DD</sub>, and AV<sub>DD</sub>. The thresholds are centered. More details are listed in Table 3 on page 11.

## DEFINITION OF SPECIFICATIONS

### Analog Bandwidth

The analog input frequency at which the spectral power of the fundamental frequency (as determined by FFT analysis) is reduced by 3 dB

### Aperture Delay

The delay in time between the falling edge of the input sampling clock and the actual time at which the sampling occurs

### Aperture Uncertainty (Jitter)

The sample-to-sample variation in aperture delay

### Clock Pulse Width/Duty Cycle

A perfect differential sine-wave clock results in a 50% clock duty cycle on the internal conversion clock. Pulse width high is the minimum amount of time that the ENCODE pulse should be left in logic 1 state to achieve rated performance. Pulse width low is the minimum time that the ENCODE pulse should be left in a low state (logic 0). At a given clock rate, these specifications define an acceptable clock duty cycle.

### Differential Nonlinearity (DNL)

An ideal ADC exhibits code transitions that are exactly one LSB apart. DNL is the deviation of any single LSB transition at the digital output from an ideal one LSB step at the analog input. If a device claims to have no missing codes, it means that all possible codes (for a 14-bit converter, 16384 codes) are present over the full operating range.

### Effective Number of Bits (ENOB)

The effective number of bits for a sine-wave input at a given input frequency can be calculated directly from its measured SINAD using the following formula:

$$\text{ENOB} = \frac{\text{SINAD} - 1.76}{6.02}$$

If SINAD is not known, SNR can be used exceptionally to calculate ENOB ( $\text{ENOB}_{\text{SNR}}$ ).

### Effective Resolution Bandwidth

The highest input frequency where the SNR (dB) is dropped by 3 dB for a full-scale input amplitude

### Gain Error

The amount of deviation between the ideal transfer function and the measured transfer function (with the offset error removed) when a full-scale analog input voltage is applied to the ADC, resulting in all ones in the digital code. Gain error is usually given in LSB or as a percent of full-scale range (%FSR).

### Integral Nonlinearity (INL)

The deviation of the transfer function from a reference line measured in fractions of one LSB using a *best straight line* or *best fit* determined by a least square curve fit. INL is independent from effects of offset, gain, or quantization errors.

### Maximum Conversion Rate

The encode rate at which parametric testing is performed. This is the maximum sampling rate where certified operation is given.

### Minimum Conversion Rate

The minimum sampling rate where the ADC still works.

### Nyquist Sampling

When the sampled frequencies of the analog input signal are below  $f_{\text{CLOCK}}/2$ , it is called Nyquist sampling. The Nyquist frequency is  $f_{\text{CLOCK}}/2$ , which can vary depending on the sample rate ( $f_{\text{CLOCK}}$ ).

### Offset Error

The deviation of output code from mid-code when both inputs are tied to common-mode

### Propagation Delay

The delay between the input clock rising edge and the time when all data bits are within valid logic levels

### Signal-to-Noise and Distortion (SINAD)

The RMS value of the sine wave  $f_{\text{IN}}$  (input sine wave for an ADC) to the RMS value of the noise of the converter from DC to the Nyquist frequency, including harmonic content. It is typically expressed in decibels (dB). SINAD includes harmonics, but excludes DC.

$$\text{SINAD} = 20\text{Log}_{(10)} \frac{\text{Input}(V_S)}{\text{Noise} + \text{Harmonics}}$$

### Signal-to-Noise Ratio (Without Harmonics)

SNR is a measure of signal strength relative to background noise. The ratio is usually measured in dB. If the incoming signal strength in  $\mu\text{V}$  is  $V_S$ , and the noise level (also in  $\mu\text{V}$ ) is  $V_N$ , the SNR in dB is given by the formula:

$$\text{SNR} = 20\text{Log}_{(10)} \frac{V_S}{V_N}$$

This is the ratio of the RMS signal amplitude,  $V_S$  (set one dB below full-scale), to the RMS value of the sum of all other spectral components,  $V_N$ , excluding harmonics and dc.

**Spurious-Free Dynamic Range (SFDR)**

The ratio of the RMS value of the analog input sine wave to the RMS value of the peak spur observed in the frequency domain. It may be reported in dBc (that is, it degrades as signal levels are lowered), or in dBFS (always related back to converter full-scale). The peak spurious component may or may not be a harmonic.

**Temperature Drift**

Temperature drift (for offset error and gain error) specifies the maximum change from the initial temperature value to the value at  $T_{MIN}$  or  $T_{MAX}$ .

**Total Harmonic Distortion (THD)**

The ratio of the RMS signal amplitude of the input sine wave to the RMS value of distortion appearing at multiples (harmonics) of the input, typically given in dBc

**Two-Tone Intermodulation Distortion Rejection**

The ratio of the RMS value of either input tone ( $f_1, f_2$ ) to the RMS value of the worst third-order intermodulation product ( $2f_1 - f_2; 2f_2 - f_1$ ). It is reported in dBc.

## TYPICAL CHARACTERISTICS

Typical values are at  $T_A = 25^\circ\text{C}$ ,  $AV_{DD} = DRV_{DD} = 3.3\text{ V}$ , differential input amplitude =  $-1\text{ dBFS}$ , sampling rate =  $125\text{ MSPS}$ , and DLL On (unless otherwise noted)

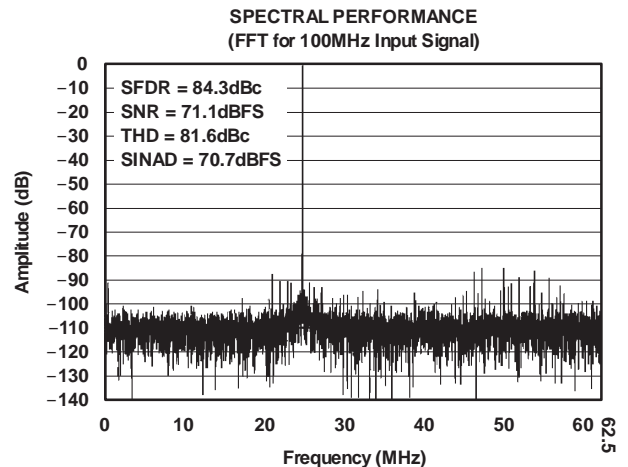
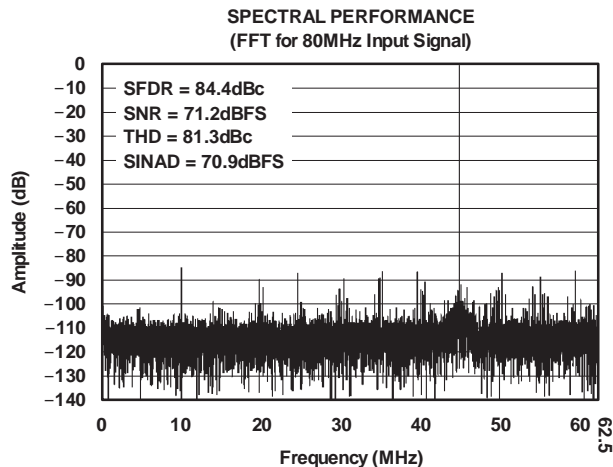
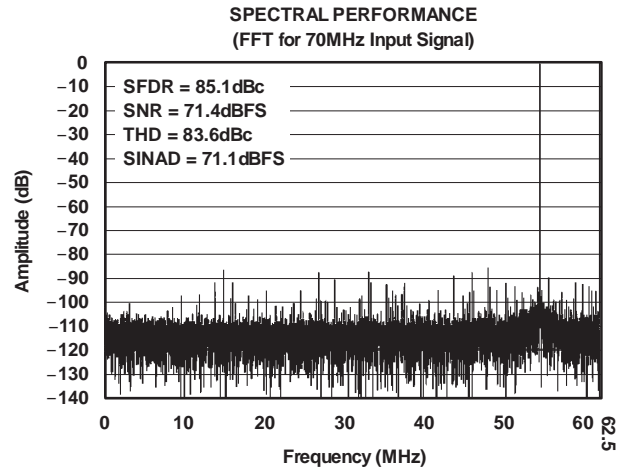
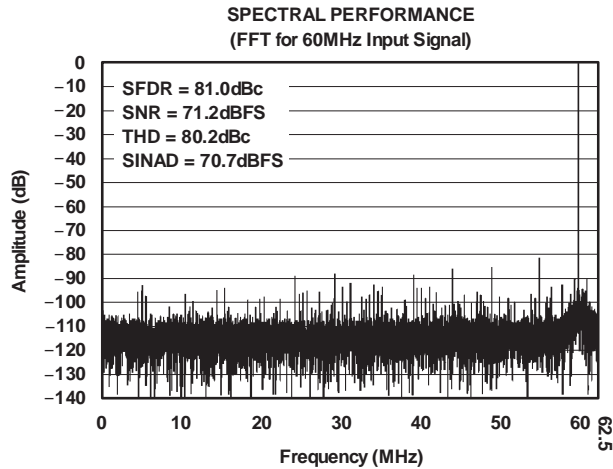
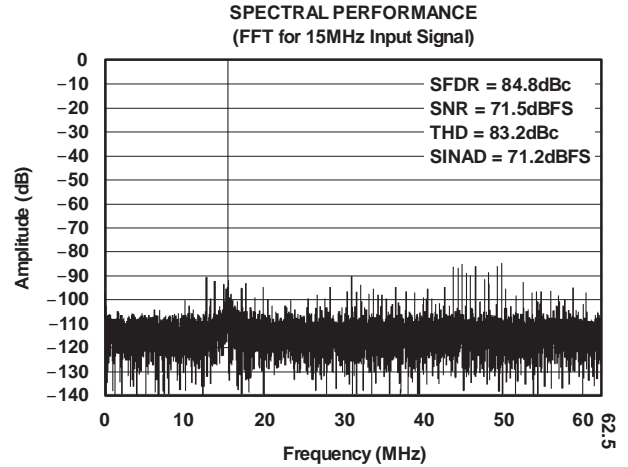
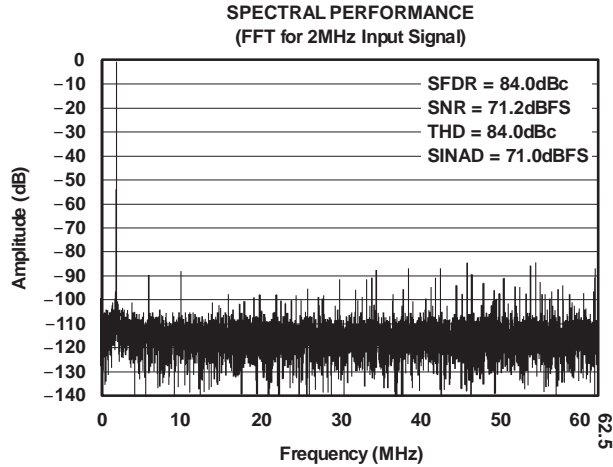

TYPICAL CHARACTERISTICS (continued)

Typical values are at  $T_A = 25^\circ\text{C}$ ,  $AV_{DD} = DRV_{DD} = 3.3\text{ V}$ , differential input amplitude =  $-1\text{ dBFS}$ , sampling rate =  $125\text{ MSPS}$ , and DLL On (unless otherwise noted)

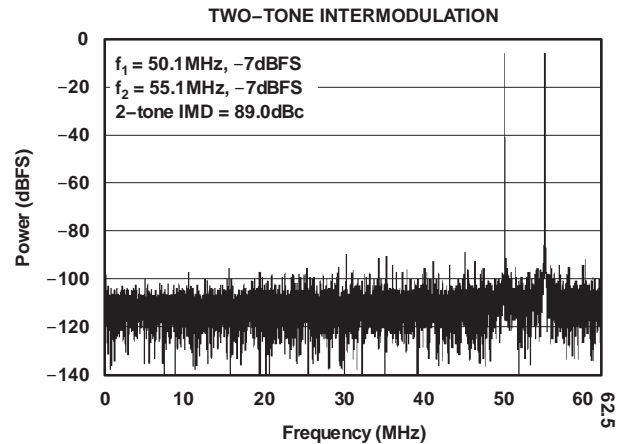
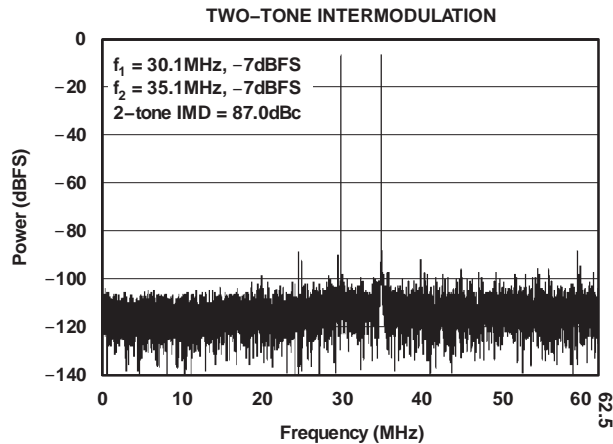
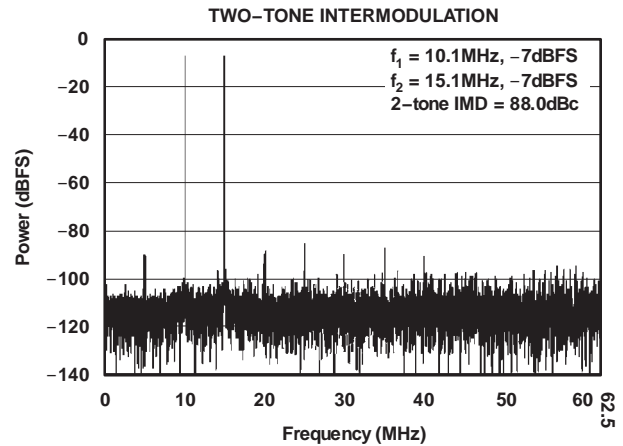
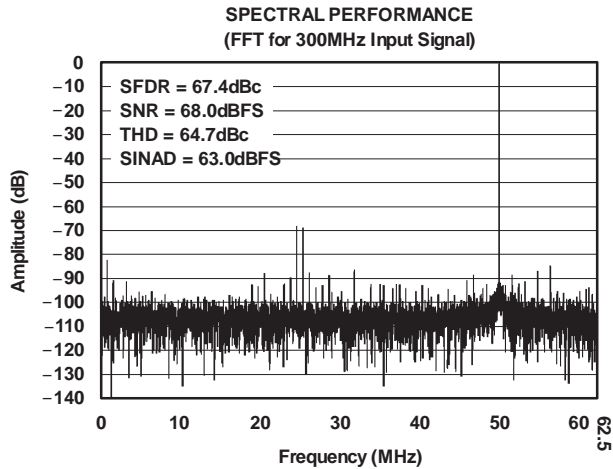
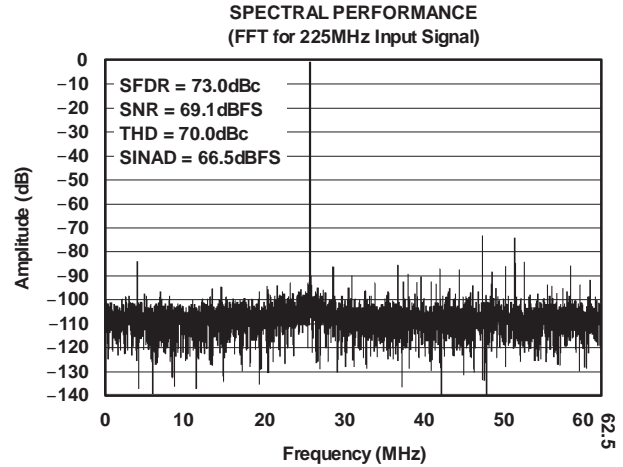
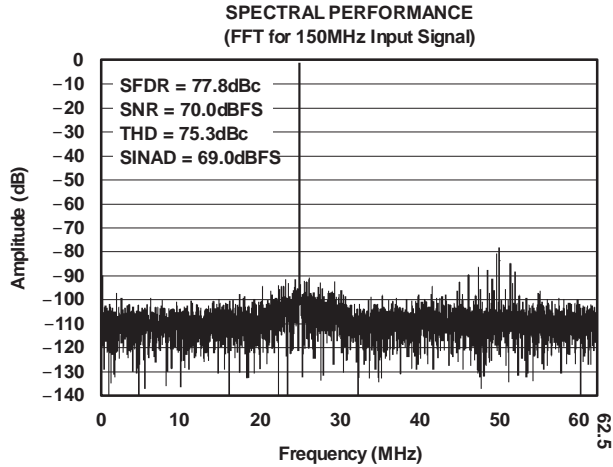



TYPICAL CHARACTERISTICS (continued)

Typical values are at  $T_A = 25^\circ\text{C}$ ,  $AV_{DD} = DRV_{DD} = 3.3\text{ V}$ , differential input amplitude =  $-1\text{ dBFS}$ , sampling rate =  $125\text{ MSPS}$ , and DLL On (unless otherwise noted)

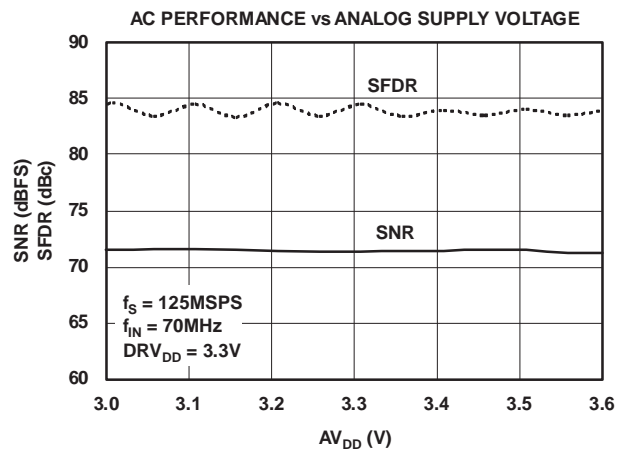
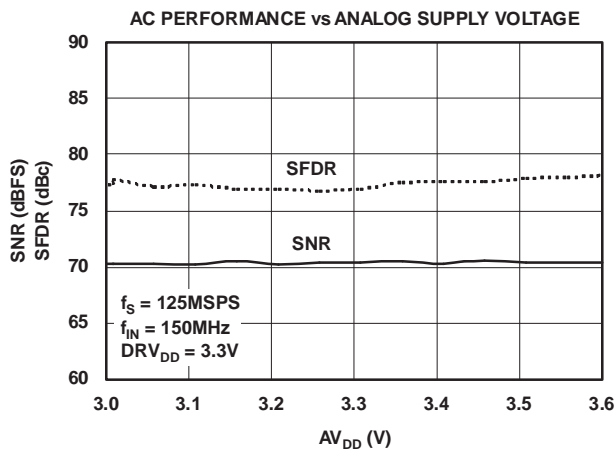
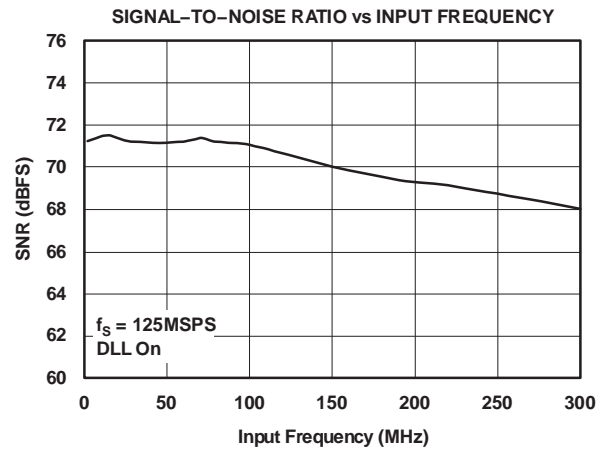
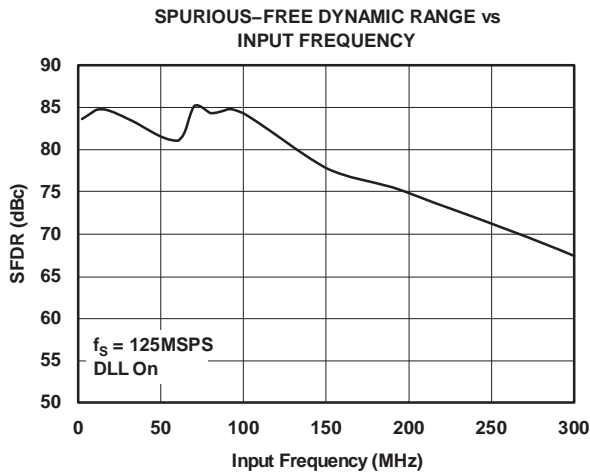
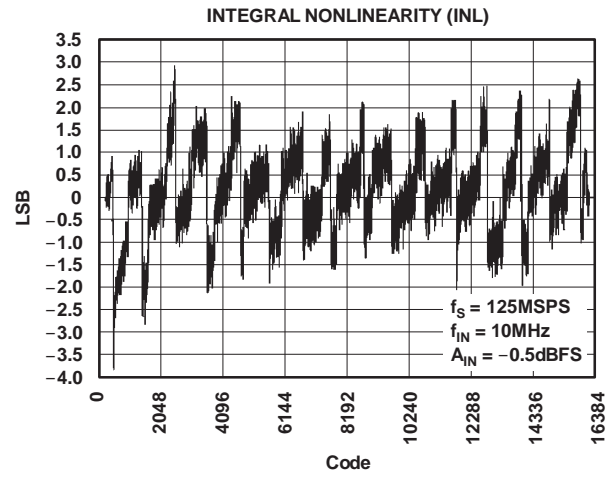
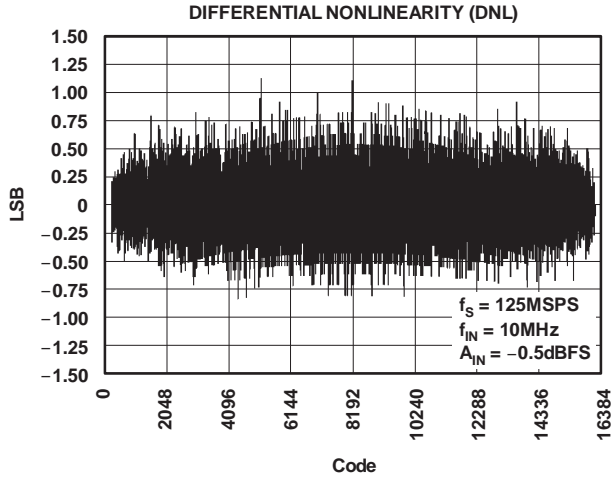

**TYPICAL CHARACTERISTICS (continued)**

Typical values are at  $T_A = 25^\circ\text{C}$ ,  $AV_{DD} = DRV_{DD} = 3.3\text{ V}$ , differential input amplitude =  $-1\text{ dBFS}$ , sampling rate =  $125\text{ MSPS}$ , and DLL On (unless otherwise noted)

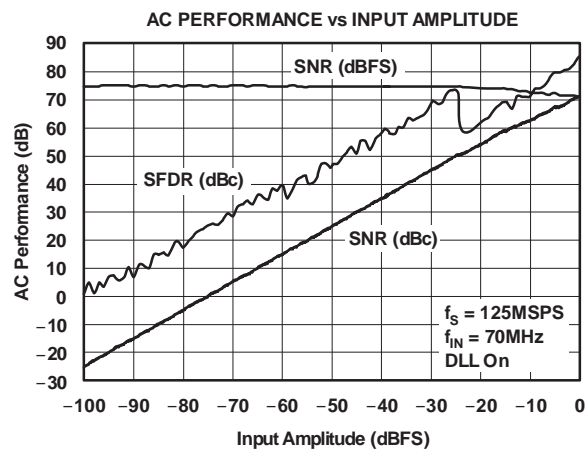
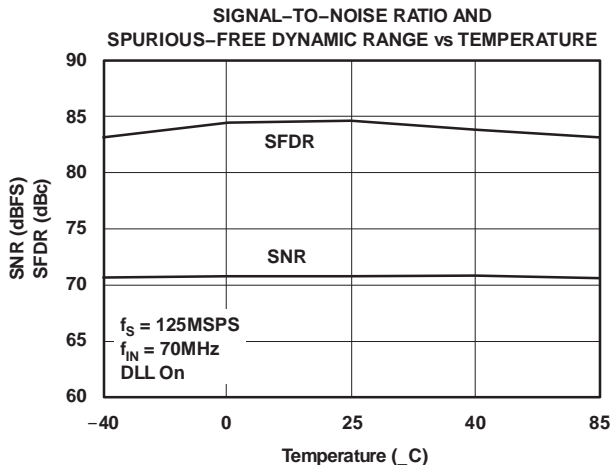
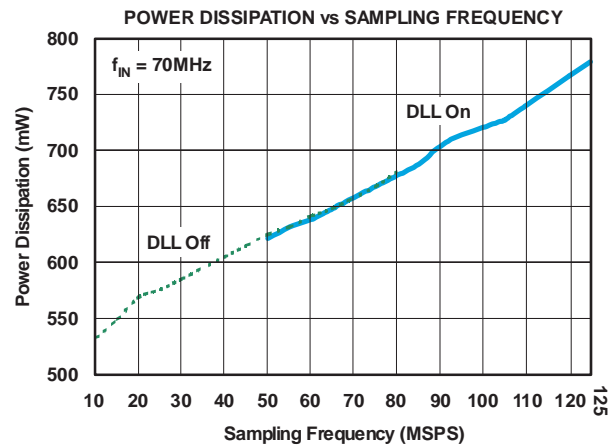
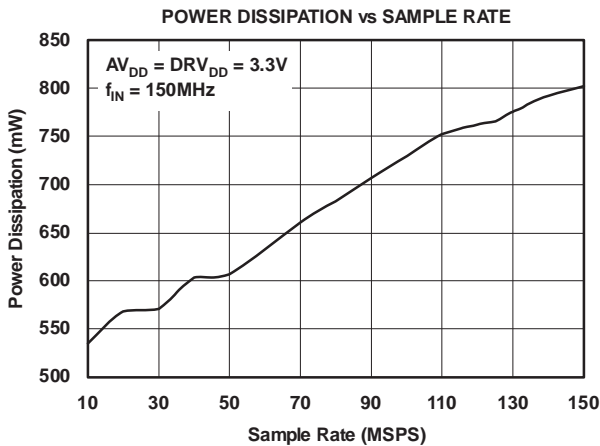
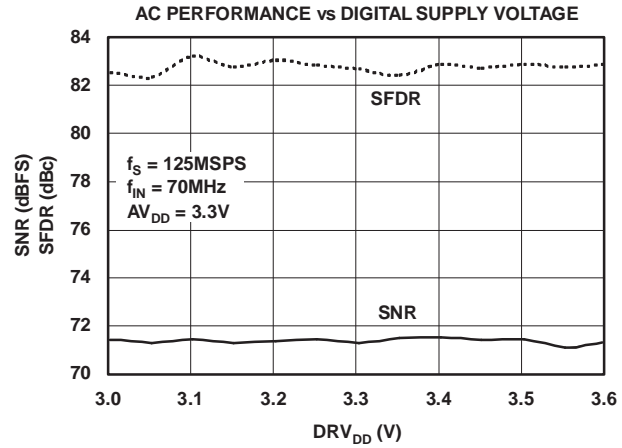
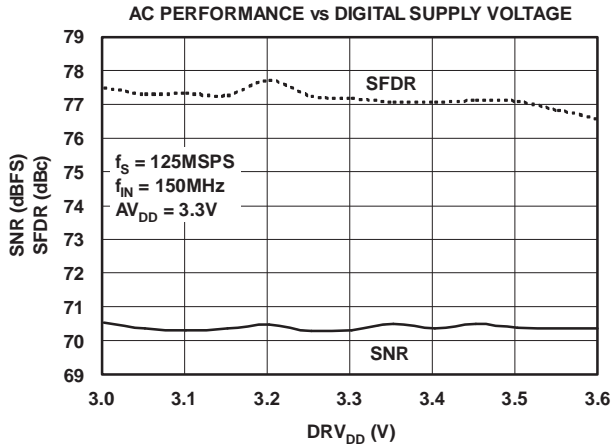

**TYPICAL CHARACTERISTICS (continued)**

Typical values are at  $T_A = 25^\circ\text{C}$ ,  $AV_{DD} = DRV_{DD} = 3.3\text{ V}$ , differential input amplitude =  $-1\text{ dBFS}$ , sampling rate =  $125\text{ MSPS}$ , and DLL On (unless otherwise noted)

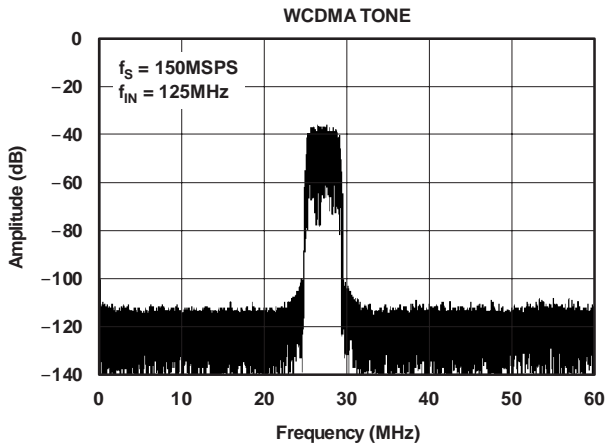
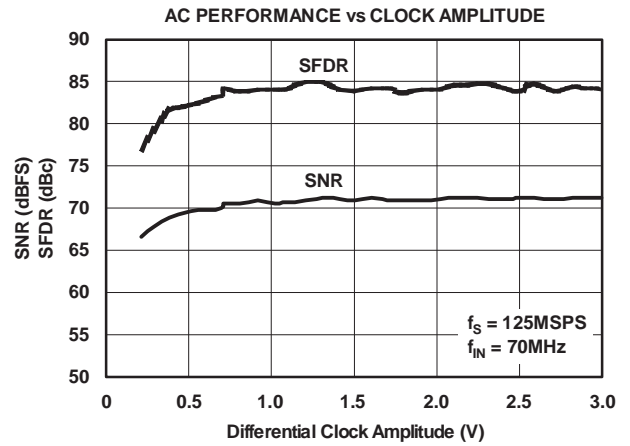
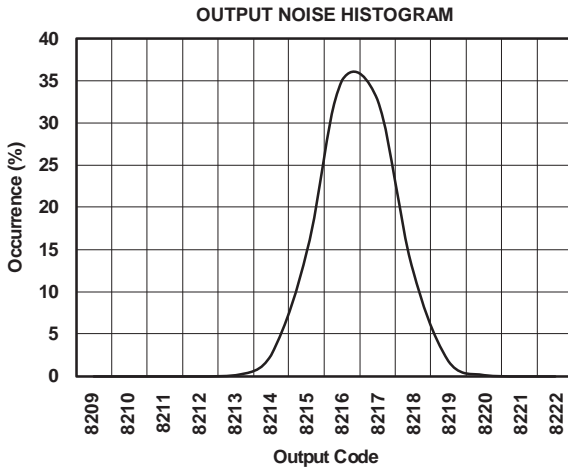
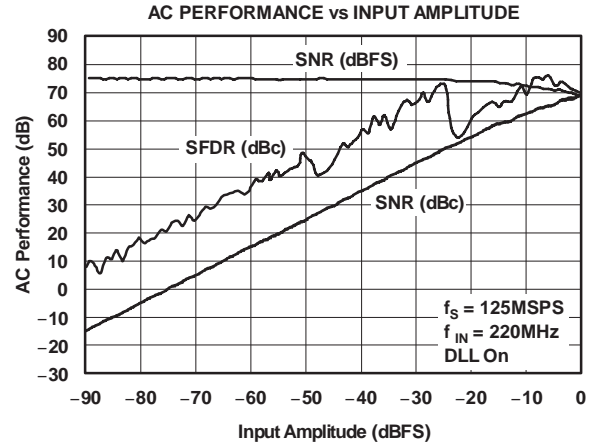
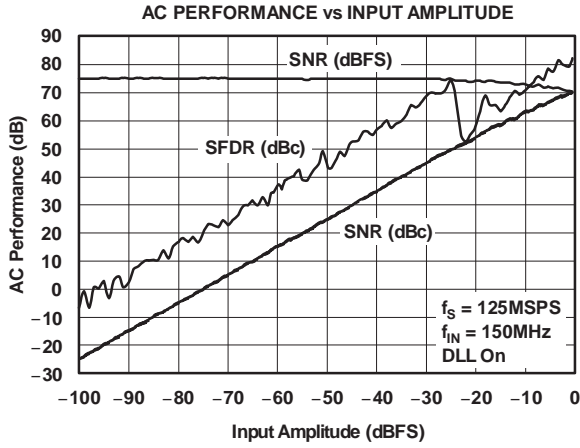

**TYPICAL CHARACTERISTICS (continued)**

Typical values are at  $T_A = 25^\circ\text{C}$ ,  $AV_{DD} = DRV_{DD} = 3.3\text{ V}$ , differential input amplitude =  $-1\text{ dBFS}$ , sampling rate =  $125\text{ MSPS}$ , and DLL On (unless otherwise noted)

**SIGNAL-TO-NOISE RATIO (SNR) WITH DLL ON**

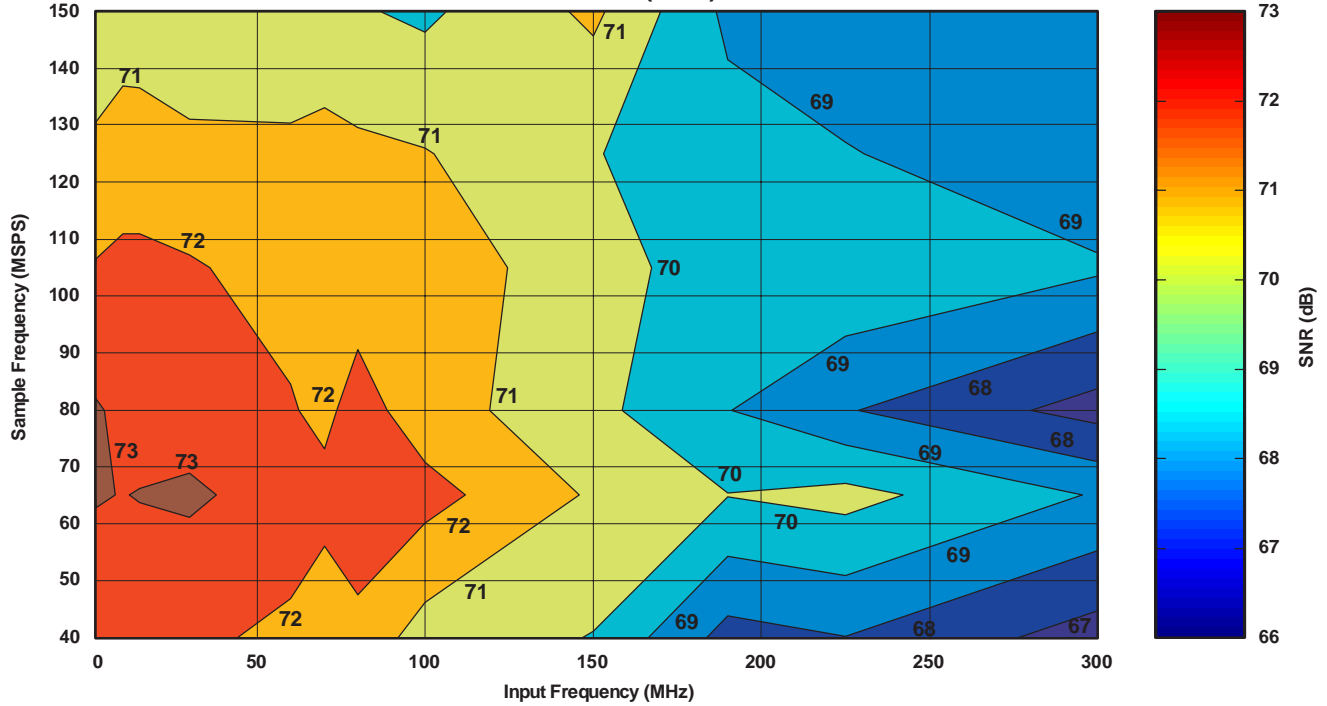

**SIGNAL-TO-NOISE RATIO (SNR) WITH DLL OFF**

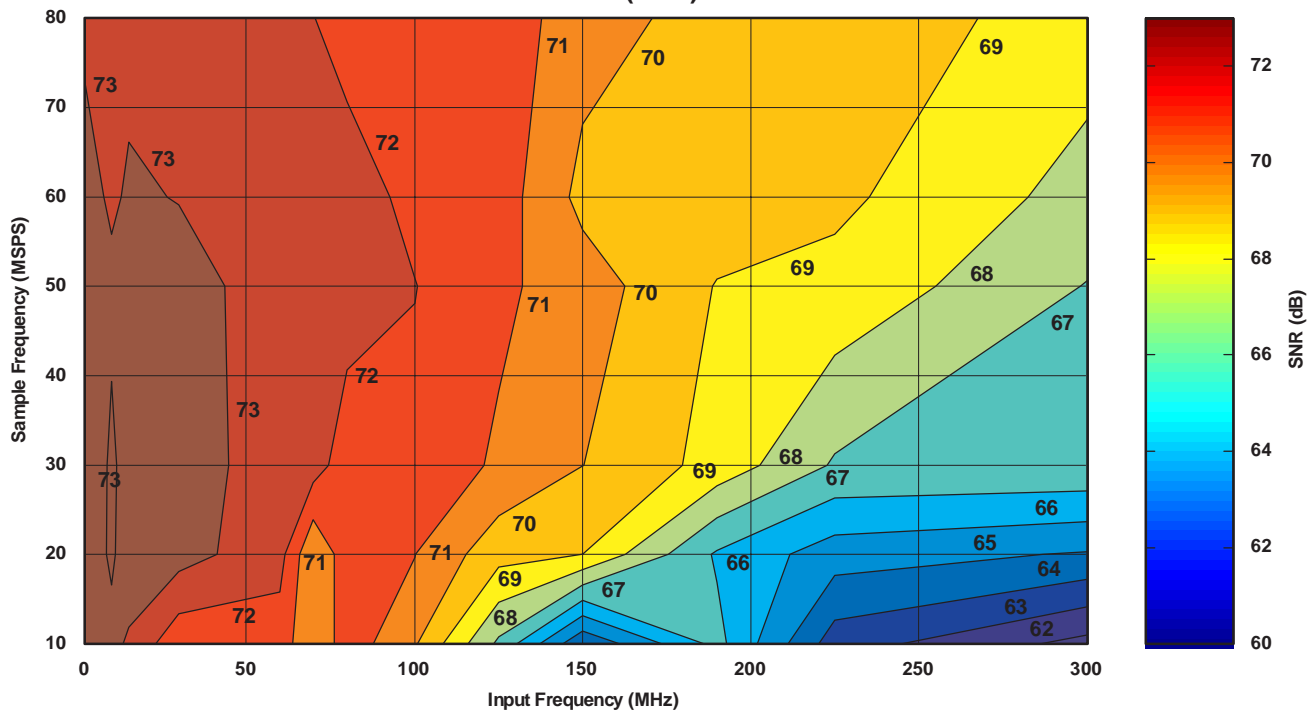

**TYPICAL CHARACTERISTICS (continued)**

Typical values are at  $T_A = 25^\circ\text{C}$ ,  $AV_{DD} = DRV_{DD} = 3.3\text{ V}$ , differential input amplitude =  $-1\text{ dBFS}$ , sampling rate =  $125\text{ MSPS}$ , and DLL On( unless otherwise noted)

**SPURIOUS-FREE DYNAMIC RANGE (SFDR) WITH DLL ON**

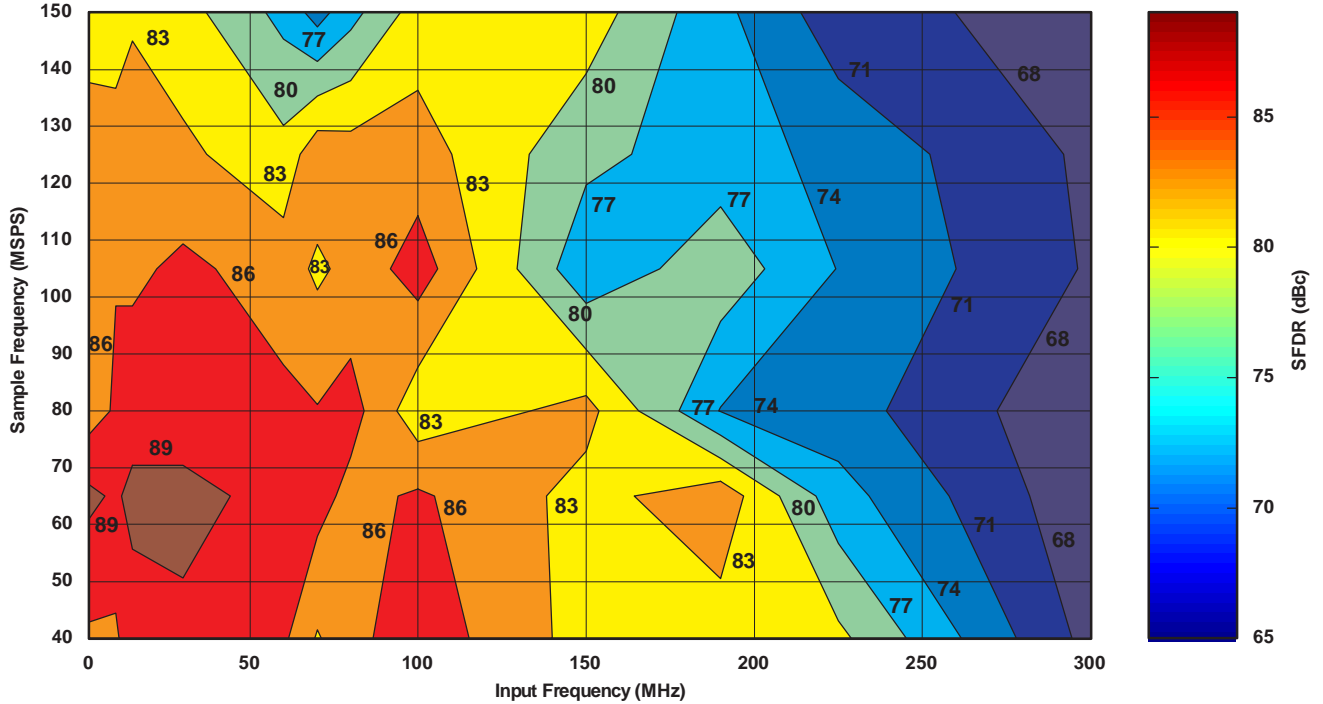

**SPURIOUS-FREE DYNAMIC RANGE (SFDR) WITH DLL OFF**

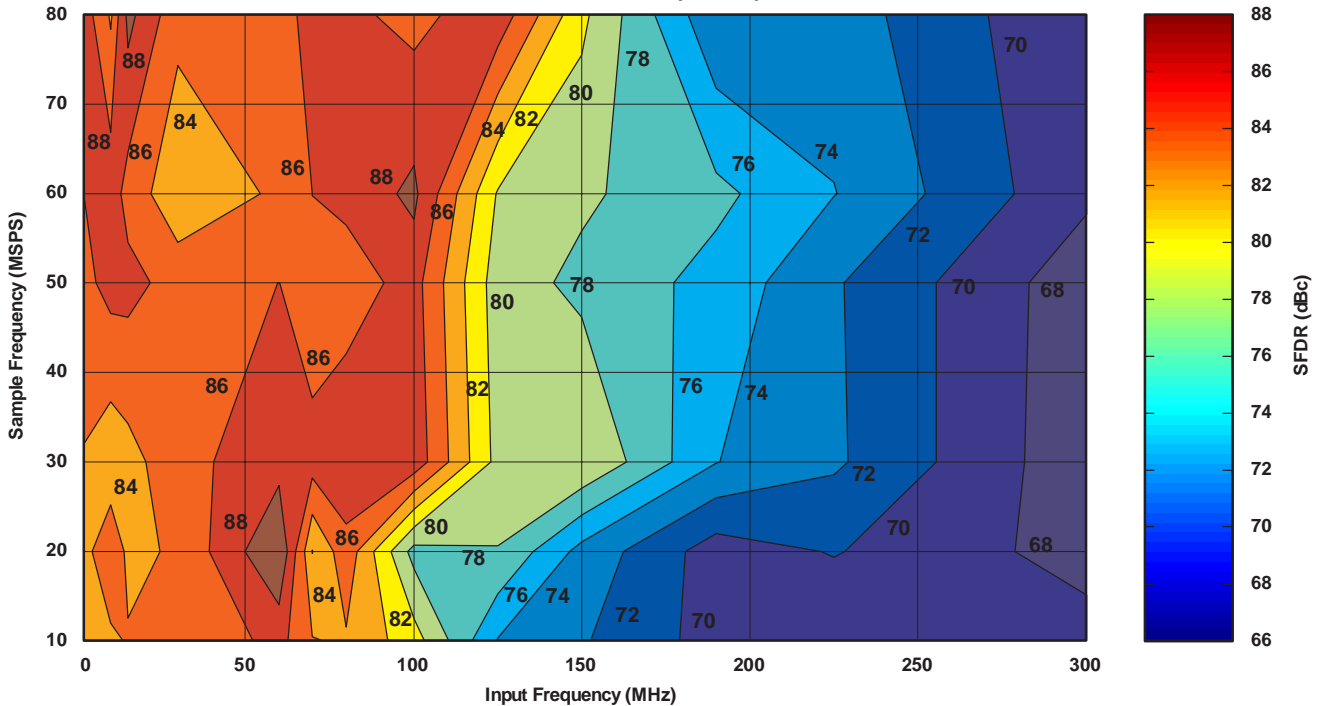

**TYPICAL CHARACTERISTICS (continued)**

Typical values are at  $T_A = 25^\circ\text{C}$ ,  $AV_{DD} = DRV_{DD} = 3.3\text{ V}$ , differential input amplitude =  $-1\text{ dBFS}$ , sampling rate =  $125\text{ MSPS}$ , and DLL On (unless otherwise noted)

**SECOND HARMONIC (HD2) WITH DLL ON**

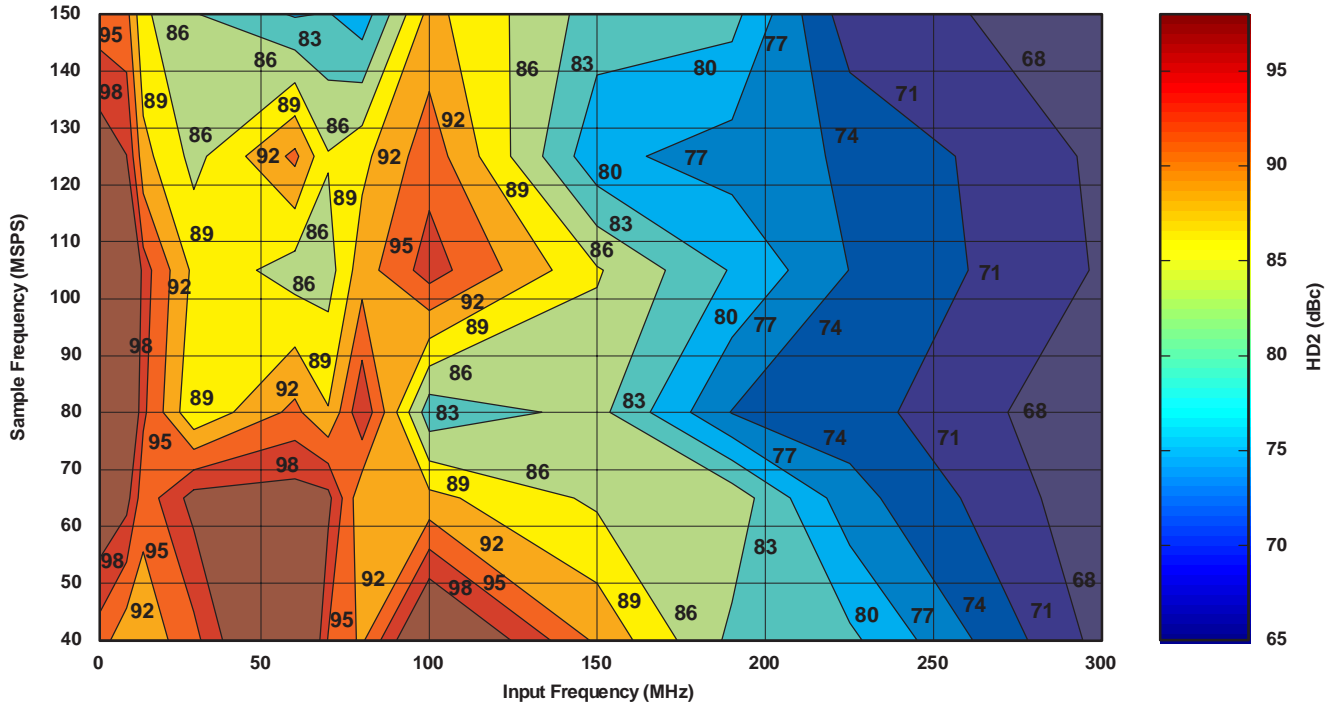

**SECOND HARMONIC (HD2) WITH DLL OFF**

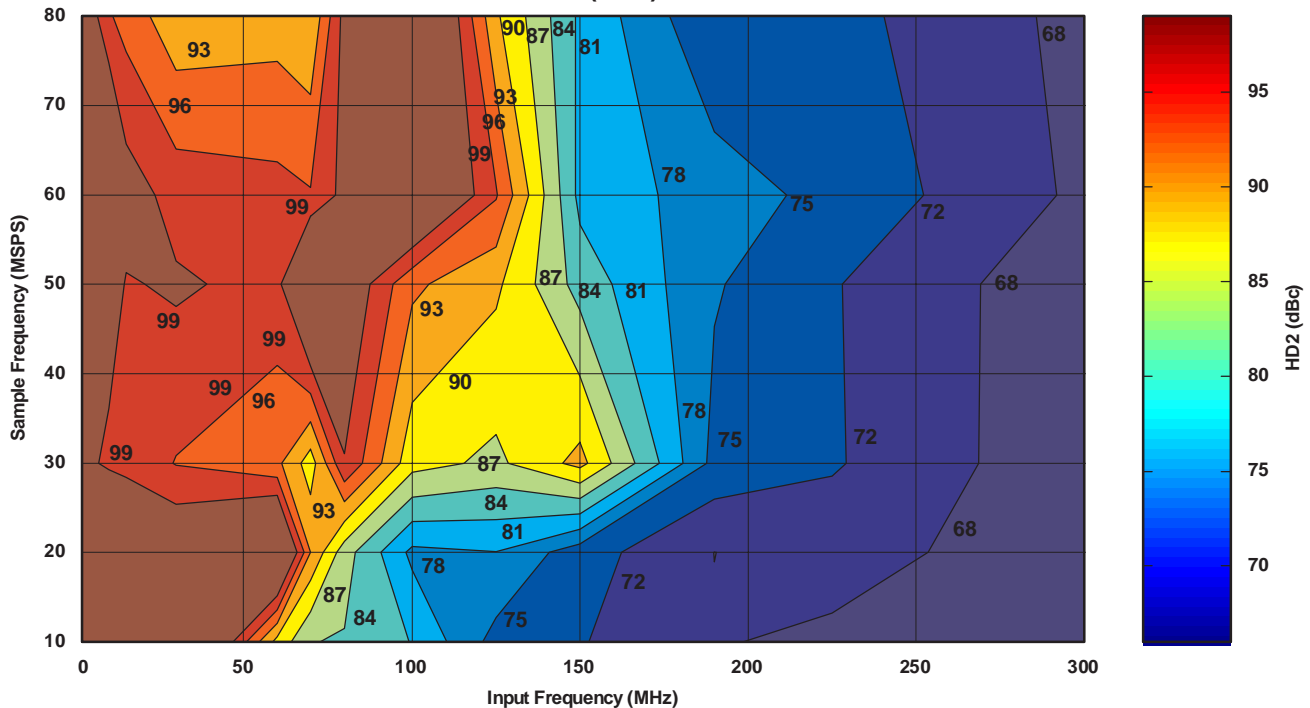

**TYPICAL CHARACTERISTICS (continued)**

Typical values are at  $T_A = 25^\circ\text{C}$ ,  $AV_{DD} = DRV_{DD} = 3.3\text{ V}$ , differential input amplitude =  $-1\text{ dBFS}$ , sampling rate =  $125\text{ MSPS}$ , and DLL On (unless otherwise noted)

**THIRD HARMONIC (HD3) WITH DLL ON**

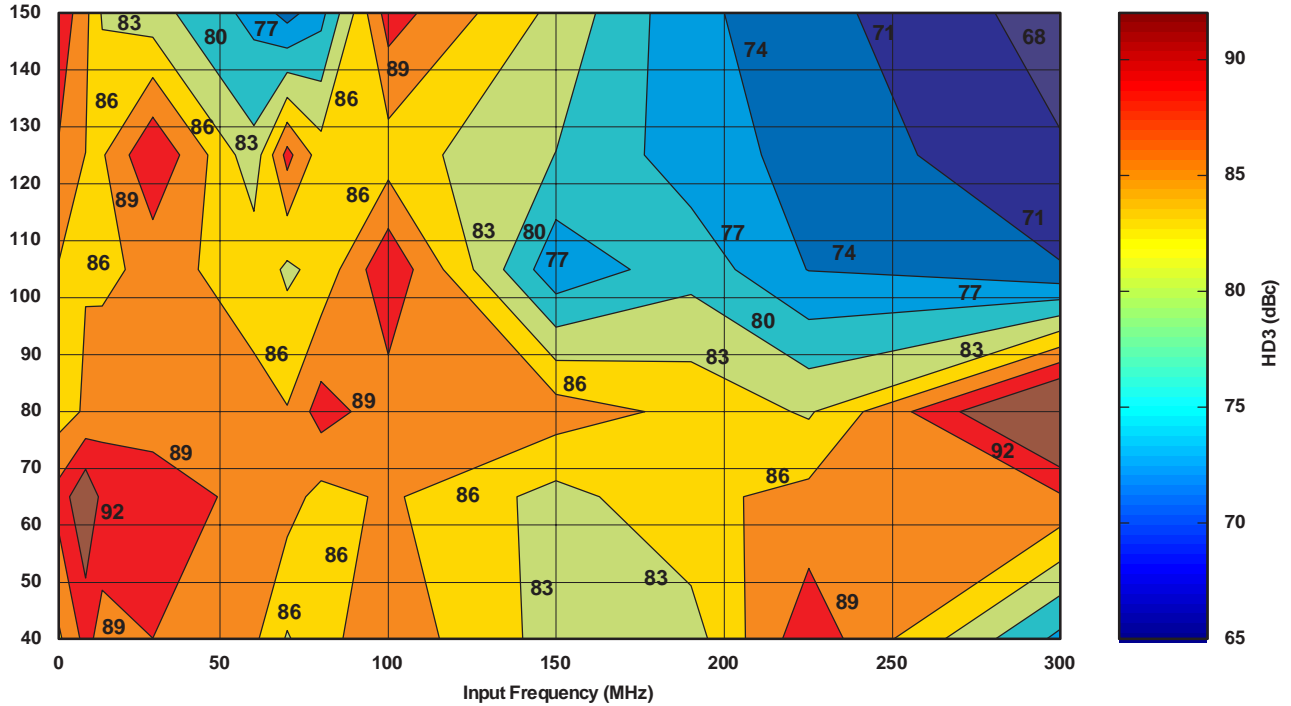

**THIRD HARMONIC (HD3) WITH DLL OFF**

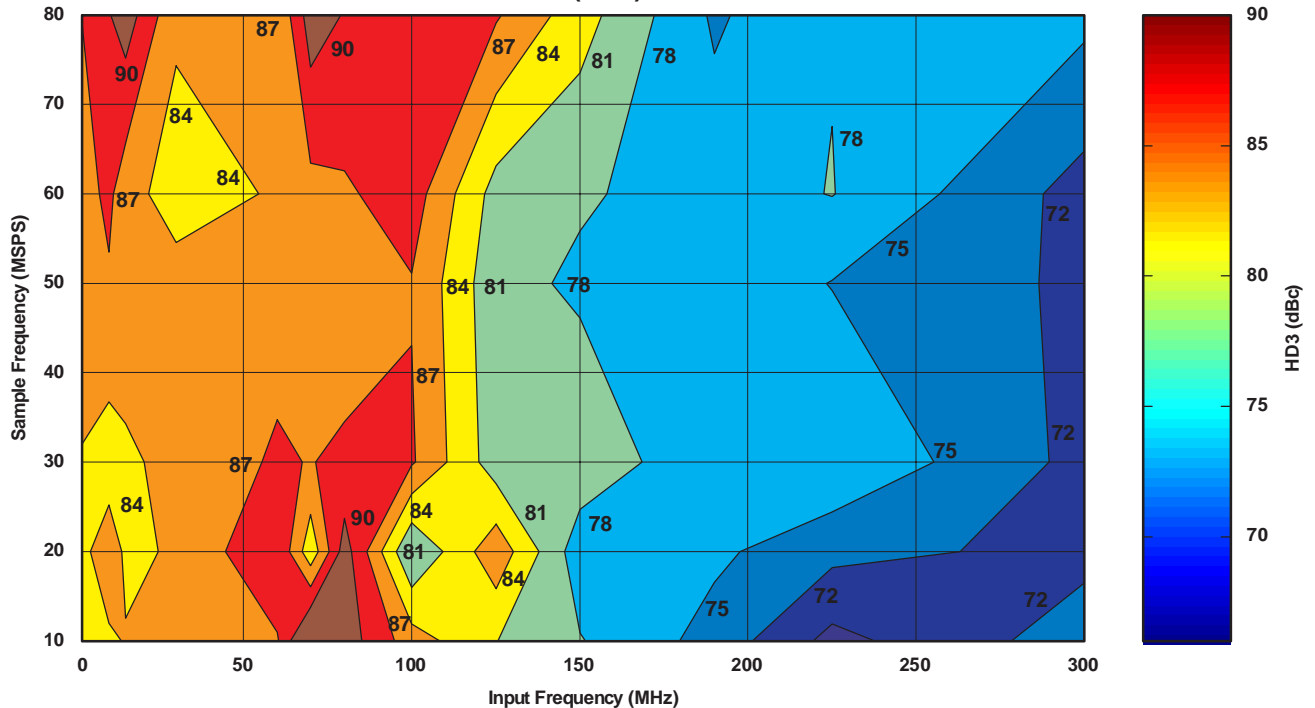

APPLICATION INFORMATION

THEORY OF OPERATION

The ADS5500 is a low-power, 14-bit, 125-MSPS, CMOS, switched-capacitor, pipeline ADC that operates from a single 3.3-V supply. The conversion process is initiated by a falling edge of the external input clock. Once the signal is captured by the input S&H, the input sample is sequentially converted by a series of small resolution stages, with the outputs combined in a digital correction logic block. Both the rising and the falling clock edges are used to propagate the sample

through the pipeline every half clock cycle. This process results in a data latency of 16.5 clock cycles, after which the output data is available as a 14-bit parallel word, coded in either straight offset binary or binary twos-complement format.

INPUT CONFIGURATION

The analog input for the ADS5500 consists of a differential architecture implemented using a switched capacitor technique, shown in Figure 5.

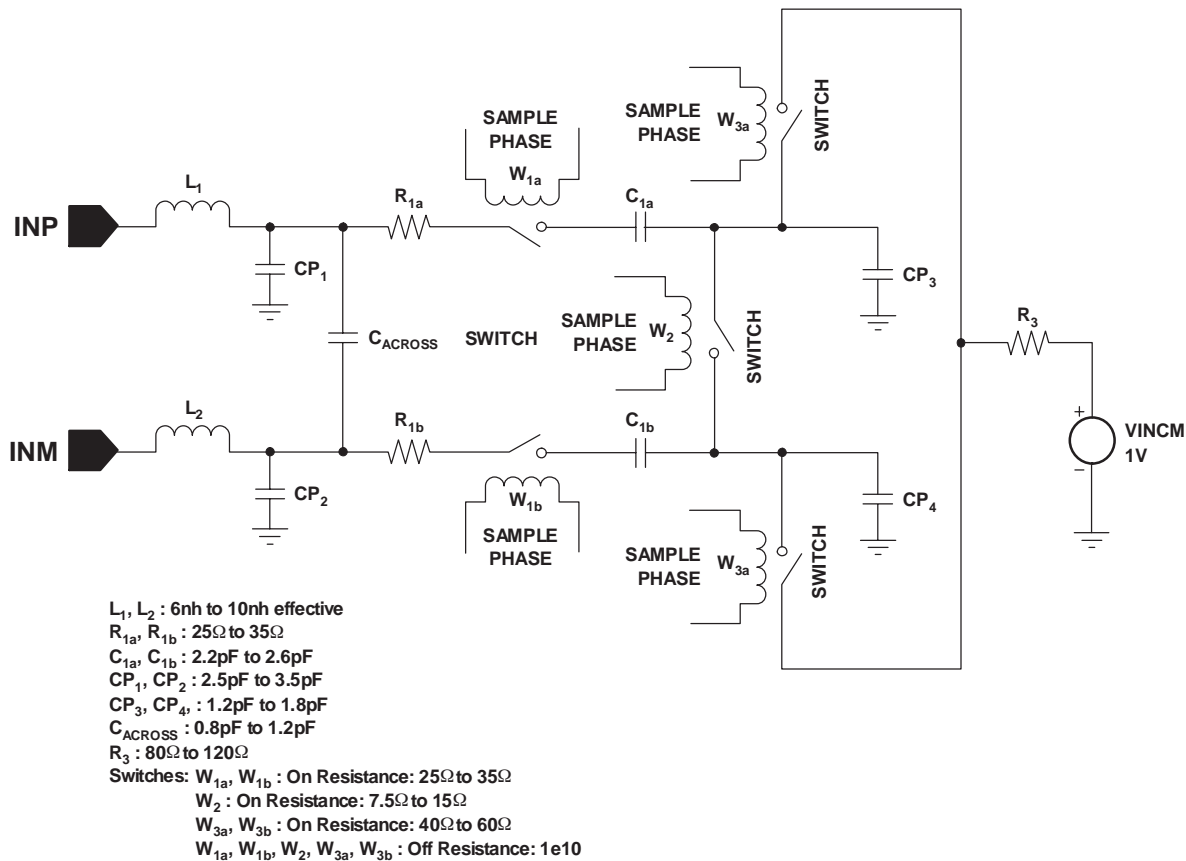

- L<sub>1</sub>, L<sub>2</sub> : 6nh to 10nh effective
- R<sub>1a</sub>, R<sub>1b</sub> : 25Ω to 35Ω
- C<sub>1a</sub>, C<sub>1b</sub> : 2.2pF to 2.6pF
- CP<sub>1</sub>, CP<sub>2</sub> : 2.5pF to 3.5pF
- CP<sub>3</sub>, CP<sub>4</sub> : 1.2pF to 1.8pF
- C<sub>ACROSS</sub> : 0.8pF to 1.2pF
- R<sub>3</sub> : 80Ω to 120Ω
- Switches: W<sub>1a</sub>, W<sub>1b</sub> : On Resistance: 25Ω to 35Ω
- W<sub>2</sub> : On Resistance: 7.5Ω to 15Ω
- W<sub>3a</sub>, W<sub>3b</sub> : On Resistance: 40Ω to 60Ω
- W<sub>1a</sub>, W<sub>1b</sub>, W<sub>2</sub>, W<sub>3a</sub>, W<sub>3b</sub> : Off Resistance: 1e10

All switches are on in sample phase.  
Approximately half of every clock period is a sample phase.

Figure 5. Analog Input Stage



This differential input topology produces a high level of ac performance for high sampling rates. It also results in a high usable input bandwidth, especially important for high intermediate frequency (IF) or undersampling applications. The ADS5500 requires each of the analog inputs (INP, INM) to be externally biased around the common-mode level of the internal circuitry (CM, pin 17). For a full-scale differential input, each of the differential lines of the input signal (pins 19 and 20) swings symmetrically between  $CM + 0.575\text{ V}$  and  $CM - 0.575\text{ V}$ . This means that each input is driven with a signal of up to  $CM \pm 0.575\text{ V}$ , so that each input has a maximum differential signal of  $1.15\text{ V}_{PP}$  for a total differential input signal swing of  $2.3\text{ V}_{PP}$ . The maximum swing is determined by the two reference voltages – the top reference (REFP, pin 29), and the bottom reference (REFM, pin 30).

The ADS5500 obtains optimum performance when the analog inputs are driven differentially. The circuit shown in Figure 6 shows one possible configuration using an RF transformer.

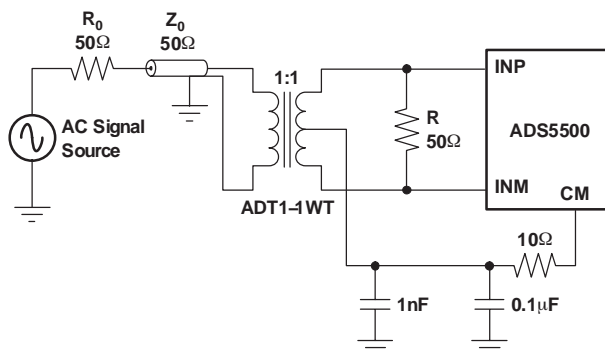

**Figure 6. Transformer Input to Convert Single-Ended Signal to Differential Signal**

The single-ended signal is fed to the primary winding of an RF transformer. Since the input signal must be biased around the common-mode voltage of the internal circuitry, the common-mode voltage ( $V_{CM}$ ) from the ADS5500 is connected to the center tap of the secondary winding. To ensure a steady low-noise  $V_{CM}$  reference, best performance is obtained when the CM (pin 17) output is filtered to ground with  $0.1\text{-}\mu\text{F}$  and  $0.01\text{-}\mu\text{F}$  low-inductance capacitors.

Output  $V_{CM}$  (pin 17) is designed to directly drive the ADC input. When providing a custom CM level, be aware that the input structure of the ADC sinks a common-mode current in the order of  $4\text{ mA}$  ( $2\text{ mA}$  per input). Equation 1 describes the dependency of the common-mode current and the sampling frequency:

$$\frac{4\text{mA} \times f_s}{125\text{MSPS}} \quad (1)$$

Where:  $f_s > 60\text{ MSPS}$ .

This equation designs the output capability and impedance of the driving circuit accordingly.

When it is necessary to buffer or apply a gain to the incoming analog signal, it is possible to combine single-ended operational amplifiers with an RF transformer or to use a differential input/output amplifier without a transformer to drive the input of the ADS5500. Texas Instruments offers a wide selection of single-ended operational amplifiers (including the THS3201, THS3202, OPA847, and OPA695) that can be selected, depending on the application. An RF gain block amplifier, such as the TI THS9001, can also be used with an RF transformer for very high input frequency applications. The THS4503 is a recommended differential input/output amplifier. Table 4 lists the recommended amplifiers.

When using single-ended operational amplifiers (such as the THS3201, THS3202, OPA847, or OPA695) to provide gain, a three-amplifier circuit is recommended with one amplifier driving the primary of an RF transformer and one amplifier in each of the legs of the secondary driving the two differential inputs of the ADS5500. These three amplifier circuits minimize even-order harmonics. For high frequency inputs, an RF gain block amplifier can be used to drive a transformer primary; in this case, the transformer secondary connections can drive the input of the ADS5500 directly (see Figure 6) or with the addition of the filter circuit (see Figure 7).

Figure 7 shows how  $R_{IN}$  and  $C_{IN}$  can be placed to isolate the signal source from the switching inputs of the ADC and to implement a low-pass RC filter to limit the input noise in the ADC. It is recommended that these components be included in the ADS5500 circuit layout when any of the amplifier circuits discussed previously are used. The components allow fine tuning of the circuit performance. Any mismatch between the differential lines of the ADS5500 input produces a degradation in performance at high input frequencies, mainly characterized by an increase in the even-order harmonics. In this case, special care should be taken to keep as much electrical symmetry as possible between both inputs.

Another possible configuration for lower-frequency signals is the use of differential input/output amplifiers that can simplify the driver circuit for applications requiring dc coupling of the input. Flexible in their configurations (see Figure 8), such amplifiers can be used for single-ended-to-differential conversion signal amplification.

**Table 4. Recommended Amplifiers to Drive Input of ADS5500**

INPUT SIGNAL FREQUENCY	RECOMMENDED AMPLIFIER	TYPE OF AMPLIFIER	USE WITH TRANSFORMER?
DC to 20 MHz	THS4503 (1)	Differential in/out amplifier	No
DC to 50 MHz	OPA847 (1)	Operational amplifier	Yes
10 MHz to 120 MHz	OPA695 (1)	Operational amplifier	Yes
	THS3201 (1)	Operational amplifier	Yes
	THS3202 (1)	Operational amplifier	Yes
Over 100 MHz	THS9001 (1)	RF gain block	Yes

(1) Potential EP devices

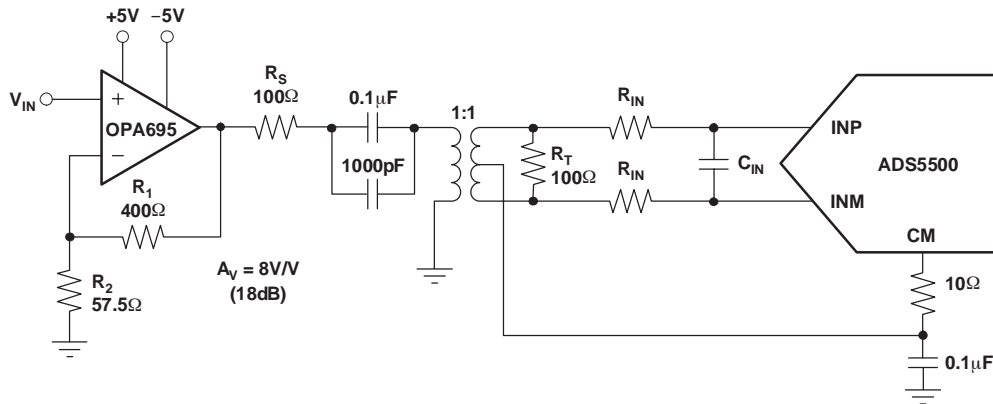

**Figure 7. Converting Single-Ended Input Signal to Differential Signal Using an RF Transformer**

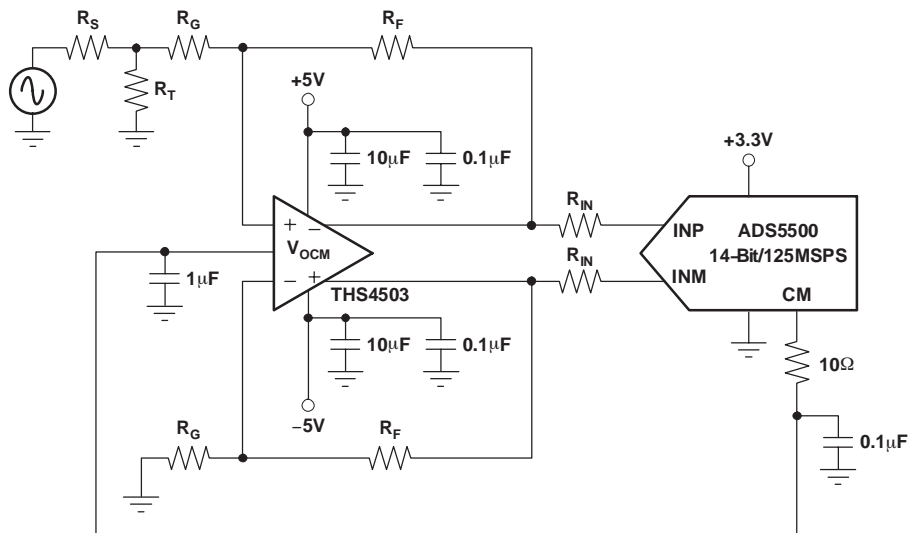

**Figure 8. Using THS4503 With ADS5500**

**POWER-SUPPLY SEQUENCE**

The ADS5500 requires a power-up sequence where the DRV<sub>DD</sub> supply must be at least 0.4 V by the time the AV<sub>DD</sub> supply reaches 3 V. Powering up both supplies at

the same time works without any problem. If this sequence is not followed, the device may stay in power-down mode.

## POWER DOWN

The device enters power down in one of two ways – either by reducing the clock speed to between dc and 1 MHz, or by setting a bit through the serial programming interface. Using the reduced clock speed, the power down may be initiated for clock frequencies below 10 MHz. For clock frequencies between 1 MHz and 10 MHz, this can vary from device to device, but will power down for clock speeds below 1 MHz.

The device can be powered down by programming the internal register (see *Serial Programming Interface* section). The outputs become 3-stated and only the internal reference is powered up to shorten the power-up time. The power-down mode reduces power dissipation to a minimum of 180 mW.

## REFERENCE CIRCUIT

The ADS5500 has built-in internal reference generation, requiring no external circuitry on the printed circuit board (PCB). For optimum performance, it is best to connect both REFP and REFM to ground with a 1- $\mu$ F decoupling capacitor in series with a 1- $\Omega$  resistor (see Figure 9). In addition, an external 56.2-k $\Omega$  resistor should be connected from IREF (pin 31) to AGND to set the proper current for the operation of the ADC (see Figure 9). No capacitor should be connected between pin 31 and ground; only the 56.2-k $\Omega$  resistor should be used.

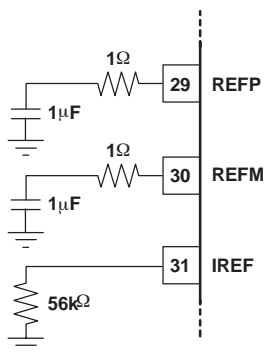

**Figure 9. REFP, REFM, and IREF Connections for Optimum Performance**

## CLOCK INPUT

The ADS5500 clock input can be driven with either a differential clock signal or a single-ended clock input, with little or no difference in performance between both configurations. The common-mode voltage of the clock inputs is set internally to CM (pin 17) using internal 5-k $\Omega$  resistors that connect CLKP (pin 10) and CLKM (pin 11) to CM (pin 17) (see Figure 10).

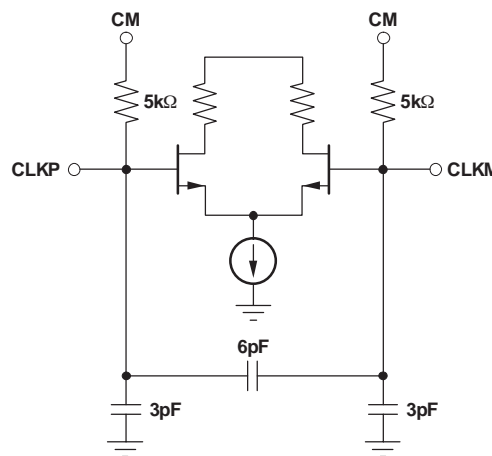

**Figure 10. Clock Inputs**

When driven with a single-ended CMOS clock input, it is best to connect CLKM (pin 11) to ground with a 0.01- $\mu$ F capacitor, while CLKP is ac coupled with a 0.01- $\mu$ F capacitor to the clock source (see Figure 11).

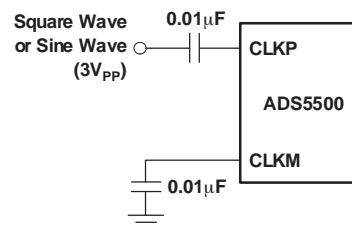

**Figure 11. AC-Coupled Single-Ended Clock Input**

The ADS5500 clock input can also be driven differentially, reducing susceptibility to common-mode noise. In this case, it is best to connect both clock inputs to the differential input clock signal with 0.01- $\mu$ F capacitors (see Figure 12).

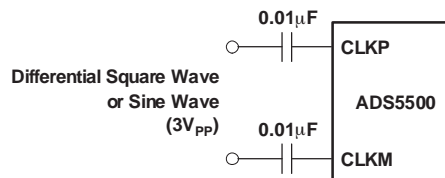

**Figure 12. AC-Coupled Differential Clock Input**

For high input frequency sampling, it is recommended to use a clock source with very low jitter. Additionally, the internal ADC core uses both edges of the clock for the conversion process. This means that, ideally, a 50% duty cycle should be provided. Figure 13 shows the performance variation of the ADC versus clock duty cycle.

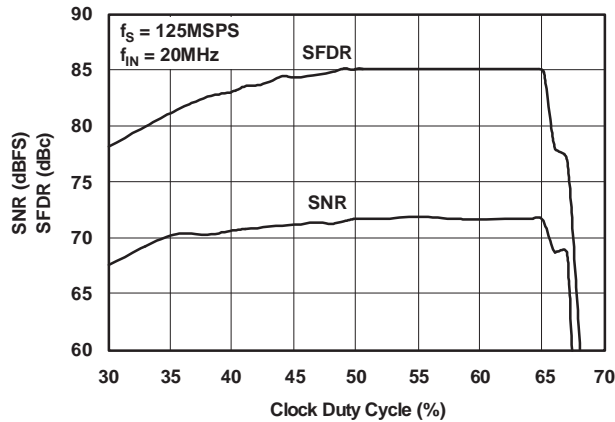

Figure 13. AC Performance vs Clock Duty Cycle

Bandpass filtering of the source can help produce a 50% duty cycle clock and reduce the effect of jitter. When using a sinusoidal clock, the clock jitter further improves as the amplitude is increased. In that sense, using a differential clock allows for the use of larger

amplitudes without exceeding the supply rails and absolute maximum ratings of the ADC clock input. Figure 14 shows the performance variation of the device versus input clock amplitude. For detailed clocking schemes based on transformer or PECL-level clocks, see the *ADS5500EVM user's guide* (SLWU010), available for download from www.ti.com.

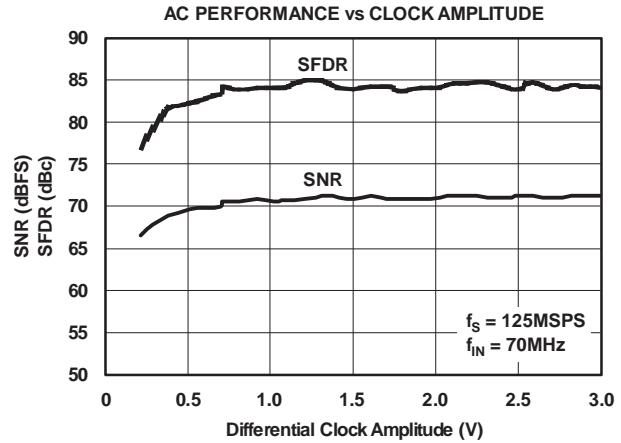

Figure 14. AC Performance vs Clock Amplitude

### INTERNAL DLL

In order to obtain the fastest sampling rates achievable with the ADS5500, the device uses an internal digital phase lock loop (DLL). Nevertheless, the limited frequency range of operation of DLL degrades the performance at clock frequencies below 60 MSPS. In order to operate the device below 60 MSPS, the internal DLL must be shut off using the DLL OFF mode described in the *Serial Interface Programming* section. The *Typical Performance Curves* show the performance obtained in both modes of operation – DLL ON (default) and DLL OFF. In either of the two modes, the device enters power-down mode if no clock or a slow clock is provided. The limit of the clock frequency where the device functions properly is ensured to be over 10 MHz.

## OUTPUT INFORMATION

The ADC provides 14 data outputs (D13 to D0, with D13 being the MSB and D0 the LSB), a data-ready signal (CLKOUT, pin 43), and an out-of-range indicator (OVR, pin 64) that equals 1 when the output reaches the full-scale limits.

Two different output formats (straight offset binary or twos complement) and two different output clock polarities (latching output data on rising or falling edge of the output clock) can be selected by setting DFS (pin 40) to one of four different voltages. Table 3 details the four modes. In addition, output enable control (OE, pin 41, active high) is provided to 3-state the outputs.

The output circuitry of the ADS5500 has been designed to minimize the noise produced by the transients of the data switching, and in particular its coupling to the ADC analog circuitry. Output D4 (pin 51) senses the load capacitance and adjusts the drive capability of all the output pins of the ADC to maintain the same output slew rate described in the timing diagram of Figure 2, as long as all outputs (including CLKOUT) have a similar load as the one at D4 (pin 51). This circuit also reduces the sensitivity of the output timing versus supply voltage or temperature. External series resistors with the output are not necessary.

## SERIAL PROGRAMMING INTERFACE

The ADS5500 has internal registers for the programming of some of the modes described in the previous sections. The registers should be reset after power up by applying a 2- $\mu$ s (minimum) high pulse on RESET (pin 35); this also resets the entire ADC and sets the data outputs to low. This pin has a 200-k $\Omega$  internal pullup resistor to  $AV_{DD}$ . The programming is done through a three-wire interface. The timing diagram and serial register setting in the *Serial Programming Interface* section describe the programming of this register.

Table 2 shows the different modes and the bit values to be written on the register to enable them.

Note that some of these modes may modify the standard operation of the device and possibly vary the performance, with respect to the typical data shown in this data sheet.

**PACKAGING INFORMATION**

Orderable Device	Status (1)	Package Type	Package Drawing	Pins	Package Qty	Eco Plan (2)	Lead/Ball Finish (6)	MSL Peak Temp (3)	Op Temp (°C)	Device Marking (4/5)	Samples
ADS5500MPAPEP	ACTIVE	HTQFP	PAP	64	160	Green (RoHS & no Sb/Br)	NIPDAU	Level-3-260C-168 HR	-55 to 125	ADS5500MEP	<a href="#">Samples</a>
ADS5500MPAPREP	ACTIVE	HTQFP	PAP	64	1000	Green (RoHS & no Sb/Br)	NIPDAU	Level-3-260C-168 HR	-55 to 125	ADS5500MEP	<a href="#">Samples</a>
V62/05613-01XE	ACTIVE	HTQFP	PAP	64	1000	Green (RoHS & no Sb/Br)	NIPDAU	Level-3-260C-168 HR	-55 to 125	ADS5500MEP	<a href="#">Samples</a>
V62/05613-02XE	ACTIVE	HTQFP	PAP	64	160	Green (RoHS & no Sb/Br)	NIPDAU	Level-3-260C-168 HR	-55 to 125	ADS5500MEP	<a href="#">Samples</a>

(1) The marketing status values are defined as follows:

**ACTIVE:** Product device recommended for new designs.

**LIFEBUY:** TI has announced that the device will be discontinued, and a lifetime-buy period is in effect.

**NRND:** Not recommended for new designs. Device is in production to support existing customers, but TI does not recommend using this part in a new design.

**PREVIEW:** Device has been announced but is not in production. Samples may or may not be available.

**OBSOLETE:** TI has discontinued the production of the device.

(2) **RoHS:** TI defines "RoHS" to mean semiconductor products that are compliant with the current EU RoHS requirements for all 10 RoHS substances, including the requirement that RoHS substance do not exceed 0.1% by weight in homogeneous materials. Where designed to be soldered at high temperatures, "RoHS" products are suitable for use in specified lead-free processes. TI may reference these types of products as "Pb-Free".

**RoHS Exempt:** TI defines "RoHS Exempt" to mean products that contain lead but are compliant with EU RoHS pursuant to a specific EU RoHS exemption.

**Green:** TI defines "Green" to mean the content of Chlorine (Cl) and Bromine (Br) based flame retardants meet JS709B low halogen requirements of <=1000ppm threshold. Antimony trioxide based flame retardants must also meet the <=1000ppm threshold requirement.

(3) MSL, Peak Temp. - The Moisture Sensitivity Level rating according to the JEDEC industry standard classifications, and peak solder temperature.

(4) There may be additional marking, which relates to the logo, the lot trace code information, or the environmental category on the device.

(5) Multiple Device Markings will be inside parentheses. Only one Device Marking contained in parentheses and separated by a "-" will appear on a device. If a line is indented then it is a continuation of the previous line and the two combined represent the entire Device Marking for that device.

(6) Lead/Ball Finish - Orderable Devices may have multiple material finish options. Finish options are separated by a vertical ruled line. Lead/Ball Finish values may wrap to two lines if the finish value exceeds the maximum column width.

**Important Information and Disclaimer:**The information provided on this page represents TI's knowledge and belief as of the date that it is provided. TI bases its knowledge and belief on information provided by third parties, and makes no representation or warranty as to the accuracy of such information. Efforts are underway to better integrate information from third parties. TI has taken and

continues to take reasonable steps to provide representative and accurate information but may not have conducted destructive testing or chemical analysis on incoming materials and chemicals. TI and TI suppliers consider certain information to be proprietary, and thus CAS numbers and other limited information may not be available for release.

In no event shall TI's liability arising out of such information exceed the total purchase price of the TI part(s) at issue in this document sold by TI to Customer on an annual basis.

**OTHER QUALIFIED VERSIONS OF ADS5500-EP :**

- Catalog: [ADS5500](#)

NOTE: Qualified Version Definitions:

- Catalog - TI's standard catalog product

**TAPE AND REEL INFORMATION**

**QUADRANT ASSIGNMENTS FOR PIN 1 ORIENTATION IN TAPE**

\*All dimensions are nominal

Device	Package Type	Package Drawing	Pins	SPQ	Reel Diameter (mm)	Reel Width W1 (mm)	A0 (mm)	B0 (mm)	K0 (mm)	P1 (mm)	W (mm)	Pin1 Quadrant
ADS5500MPAPREP	HTQFP	PAP	64	1000	330.0	24.4	13.0	13.0	1.5	16.0	24.0	Q2



**TAPE AND REEL BOX DIMENSIONS**



\*All dimensions are nominal

Device	Package Type	Package Drawing	Pins	SPQ	Length (mm)	Width (mm)	Height (mm)
ADS5500MPAPREP	HTQFP	PAP	64	1000	350.0	350.0	43.0

PAP (S-PQFP-G64)

PowerPAD™ PLASTIC QUAD FLATPACK

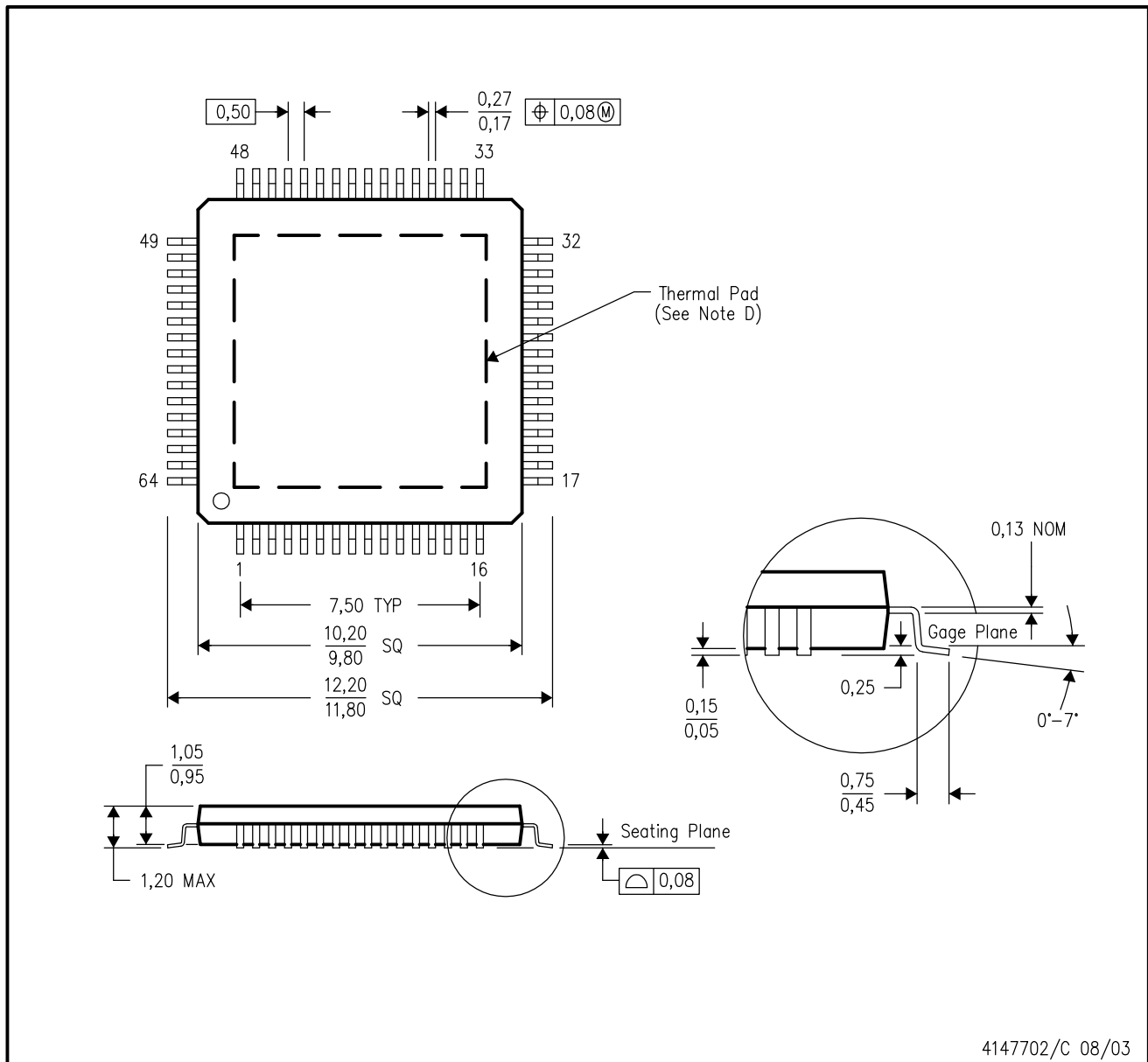

- NOTES:
- A. All linear dimensions are in millimeters.
  - B. This drawing is subject to change without notice.
  - C. Body dimensions do not include mold flash or protrusion
  - D. This package is designed to be soldered to a thermal pad on the board. Refer to Technical Brief, PowerPad Thermally Enhanced Package, Texas Instruments Literature No. SLMA002 for information regarding recommended board layout. This document is available at [www.ti.com](http://www.ti.com) <<http://www.ti.com>>.
  - E. Falls within JEDEC MS-026

PowerPAD is a trademark of Texas Instruments.

# THERMAL PAD MECHANICAL DATA

PAP (S-PQFP-G64)

PowerPAD™ PLASTIC QUAD FLATPACK

## THERMAL INFORMATION

This PowerPAD™ package incorporates an exposed thermal pad that is designed to be attached to a printed circuit board (PCB). The thermal pad must be soldered directly to the PCB. After soldering, the PCB can be used as a heatsink. In addition, through the use of thermal vias, the thermal pad can be attached directly to the appropriate copper plane shown in the electrical schematic for the device, or alternatively, can be attached to a special heatsink structure designed into the PCB. This design optimizes the heat transfer from the integrated circuit (IC).

For additional information on the PowerPAD package and how to take advantage of its heat dissipating abilities, refer to Technical Brief, PowerPAD Thermally Enhanced Package, Texas Instruments Literature No. SLMA002 and Application Brief, PowerPAD Made Easy, Texas Instruments Literature No. SLMA004. Both documents are available at [www.ti.com](http://www.ti.com).

The exposed thermal pad dimensions for this package are shown in the following illustration.

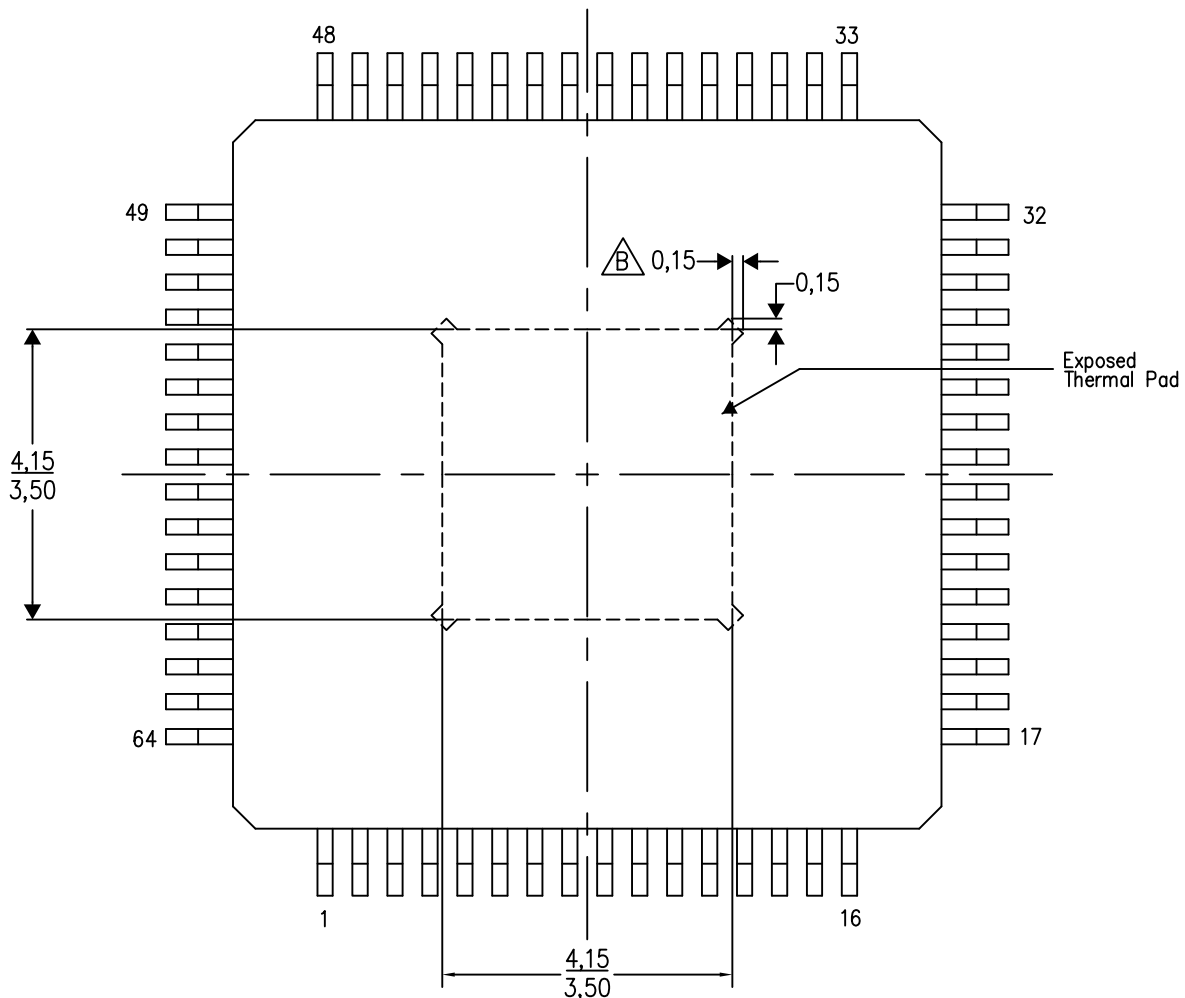

Top View  
Exposed Thermal Pad Dimensions

4206326-2/P 05/14

NOTES: A. All linear dimensions are in millimeters

 Tie strap features may not be present.

PowerPAD is a trademark of Texas Instruments

# LAND PATTERN DATA

PAP (S-PQFP-G64)

PowerPAD™ PLASTIC QUAD FLATPACK

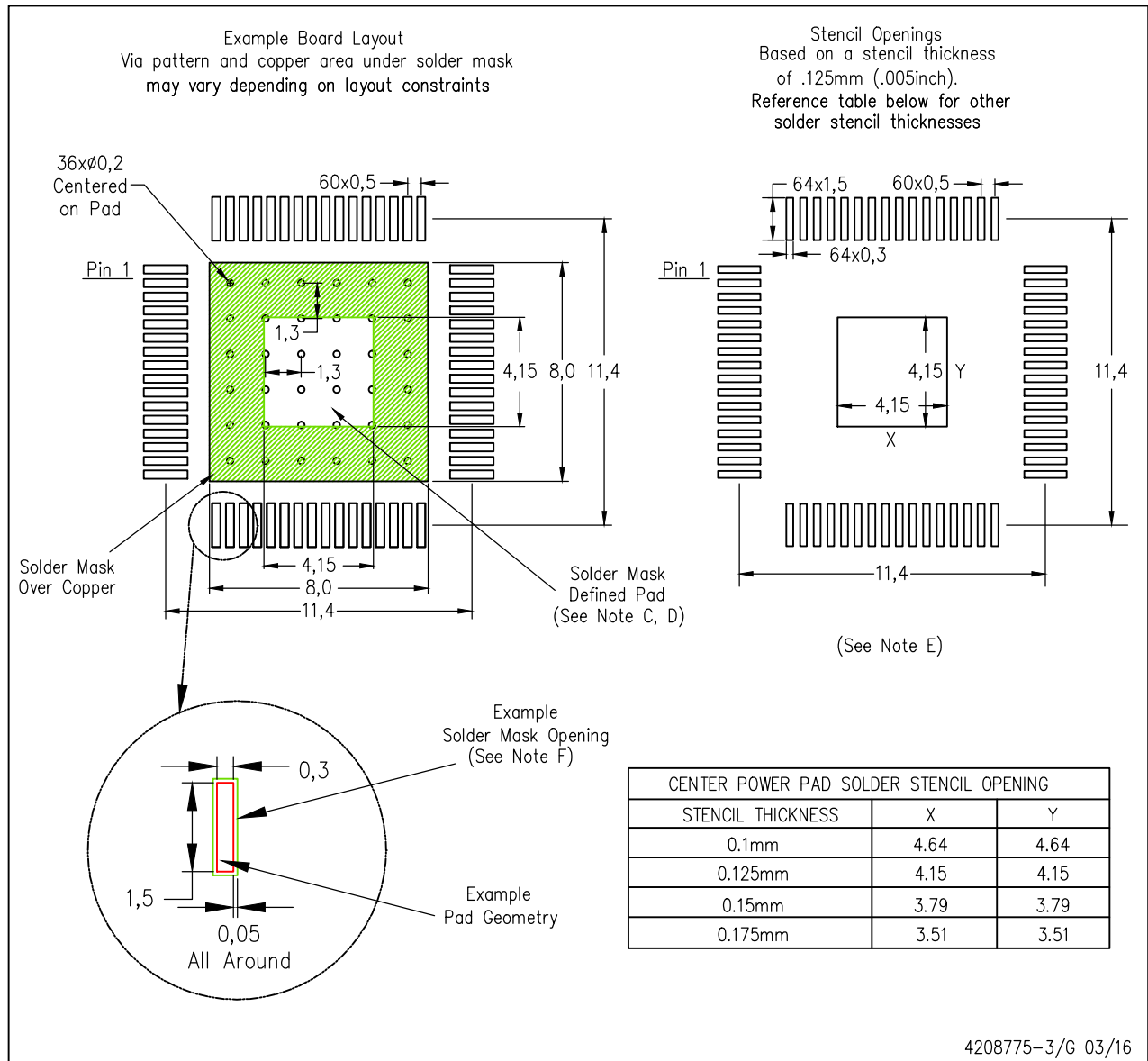

- NOTES:
- A. All linear dimensions are in millimeters.
  - B. This drawing is subject to change without notice.
  - C. Customers should place a note on the circuit board fabrication drawing not to alter the center solder mask defined pad.
  - D. This package is designed to be soldered to a thermal pad on the board. Refer to Technical Brief, PowerPad Thermally Enhanced Package, Texas Instruments Literature No. SLMA002, SLMA004, and also the Product Data Sheets for specific thermal information, via requirements, and recommended board layout. These documents are available at [www.ti.com](http://www.ti.com) <<http://www.ti.com>>. Publication IPC-7351 is recommended for alternate designs.
  - E. Laser cutting apertures with trapezoidal walls and also rounding corners will offer better paste release. Customers should contact their board assembly site for stencil design recommendations. Example stencil design based on a 50% volumetric metal load solder paste. Refer to IPC-7525 for other stencil recommendations.
  - F. Customers should contact their board fabrication site for solder mask tolerances between and around signal pads.
- PowerPAD is a trademark of Texas Instruments**

## IMPORTANT NOTICE AND DISCLAIMER

TI PROVIDES TECHNICAL AND RELIABILITY DATA (INCLUDING DATASHEETS), DESIGN RESOURCES (INCLUDING REFERENCE DESIGNS), APPLICATION OR OTHER DESIGN ADVICE, WEB TOOLS, SAFETY INFORMATION, AND OTHER RESOURCES "AS IS" AND WITH ALL FAULTS, AND DISCLAIMS ALL WARRANTIES, EXPRESS AND IMPLIED, INCLUDING WITHOUT LIMITATION ANY IMPLIED WARRANTIES OF MERCHANTABILITY, FITNESS FOR A PARTICULAR PURPOSE OR NON-INFRINGEMENT OF THIRD PARTY INTELLECTUAL PROPERTY RIGHTS.

These resources are intended for skilled developers designing with TI products. You are solely responsible for (1) selecting the appropriate TI products for your application, (2) designing, validating and testing your application, and (3) ensuring your application meets applicable standards, and any other safety, security, or other requirements. These resources are subject to change without notice. TI grants you permission to use these resources only for development of an application that uses the TI products described in the resource. Other reproduction and display of these resources is prohibited. No license is granted to any other TI intellectual property right or to any third party intellectual property right. TI disclaims responsibility for, and you will fully indemnify TI and its representatives against, any claims, damages, costs, losses, and liabilities arising out of your use of these resources.

TI's products are provided subject to TI's Terms of Sale ([www.ti.com/legal/termsofsale.html](http://www.ti.com/legal/termsofsale.html)) or other applicable terms available either on [ti.com](http://ti.com) or provided in conjunction with such TI products. TI's provision of these resources does not expand or otherwise alter TI's applicable warranties or warranty disclaimers for TI products.

Mailing Address: Texas Instruments, Post Office Box 655303, Dallas, Texas 75265  
Copyright © 2020, Texas Instruments Incorporated