

Nozzle mounted in fan inlet side to adjust the flow of introduced air. Material: Steel sheet

Ø133 mm type

Model no.	Surface treatment	Mass (g)
109-1069	Electro nickel plating (silver)	76
109-1069H	Cation electropainting (black)	

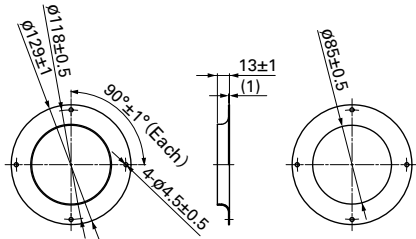

Mounting example

Centrifugal fan

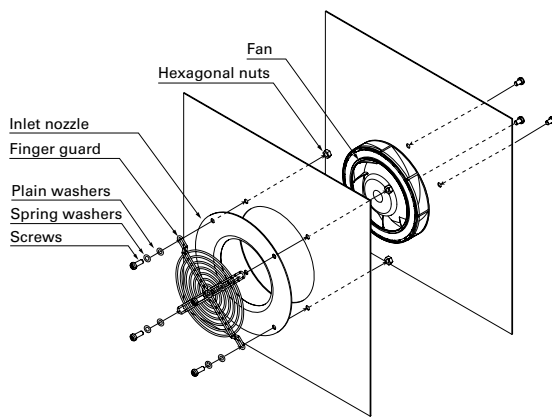

Mouser Electronics

Authorized Distributor

Click to View Pricing, Inventory, Delivery & Lifecycle Information:

[Sanyo Denki:](#)

[109-1069](#)