

General Description

The MIC47100 is a high speed, Low V_{IN} LDO capable of delivering up to 1A and designed to take advantage of point of load applications that use multiple supply rails to generate a low voltage, high current power supply. The MIC47100 is stable with only a 1 μ F ceramic output capacitor and is available in a thermally enhanced 2mm \times 2mm MLF[®] package thus making it an optimal solution for board-constrained applications.

The MIC47100 has an NMOS output stage offering very low output impedance. The NMOS output stage offers a unique ability to respond very quickly to sudden load changes such as that required by a microprocessor, DSP or FPGA. The MIC47100 consumes little quiescent current and therefore can be used for driving the core voltages of mobile processors, post regulating a core DC/DC converter in any portable device.

The MIC47100 is available in fixed and adjustable output voltages in the exposed pad MSOP-8 package and the tiny 2mm \times 2mm MLF[®] package with an operating junction temperature range of -40°C to +125°C.

Data sheets and support documentation can be found on Micrel's web site at: www.micrel.com.

Features

- Operating voltage range:
 - Input Supply: 1.0V to 3.6V
 - Bias Supply: 2.3V to 5.5V
- 0.8V to 2.0V output voltage range
- High bandwidth – very fast transient response
- PSRR >50dB at 100kHz
- Stable with a 1 μ F ceramic output capacitor
- Low dropout voltage of 80mV at 1A
- High output voltage accuracy:
 - +/- 1.5% initial accuracy
 - +/- 2% over temperature
- Logic level enable input
- UVLO on both supply voltages for easy turn-on
- ePad MSOP-8 – small form factor power package
- Thermally enhanced 2mm \times 2mm MLF[®] – smallest solution

Applications:

- Point of Load
- PDAs
- DSP, PLD and FPGA Power Supply
- Low Voltage Post Regulation

Typical Application

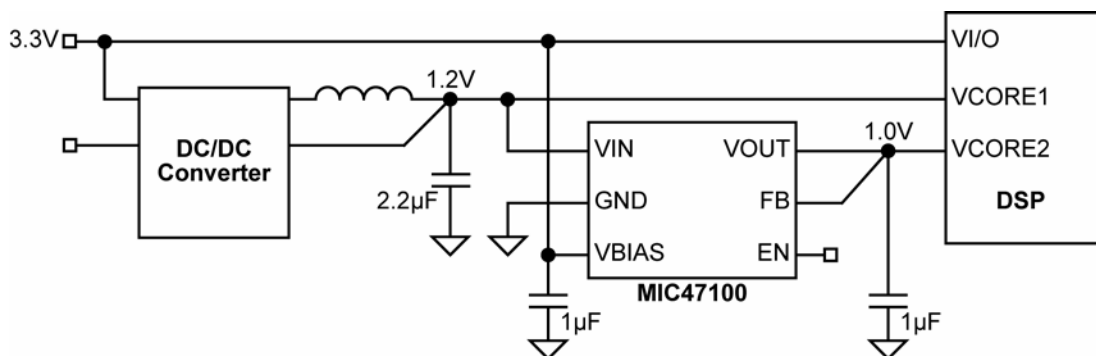

Ordering Information

Part Number	Marking Code	Nominal Output Voltage ⁽¹⁾	Package	Lead Finish
MIC47100YML	EAA	ADJ	8-Pin 2mm × 2mm MLF ^{®(2)}	Pb free
MIC47100-0.8YML	E08	0.8V	8-Pin 2mm × 2mm MLF ^{®(2)}	Pb free
MIC47100-1.0YML	E10	1.0V	8-Pin 2mm × 2mm MLF ^{®(2)}	Pb free
MIC47100-1.2YML	E12	1.2V	8-Pin 2mm × 2mm MLF ^{®(2)}	Pb free
MIC47100YMME	ZEAAY	ADJ	8-pin e-MSOP	Pb free
MIC47100-08YMME	ZE08Y	0.8V	8-pin e-MSOP	Pb free
MIC47100-10YMME	ZE10Y	1.0V	8-pin e-MSOP	Pb free
MIC47100-12YMME	ZE12Y	1.2V	8-pin e-MSOP	Pb free

Note:

1. Other Voltage available. Contact Micrel for details.
2. MLF[®] is a Green RoHS compliant package. Lead finish is NiPdAu. Mold compound is Halogen free

Pin Configuration

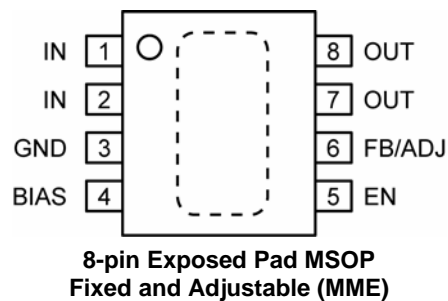
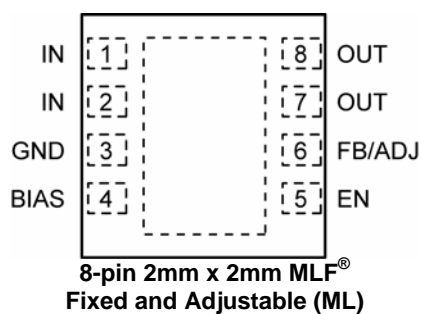

Pin Description

Pin Number MLF	Pin Number MSOP	Pin Name	Pin Name
1,2	1,2	IN	Input Supply. Drain of NMOS pass transistor which is the power input voltage for regulator. The NMOS pass transistor steps down this input voltage to create the output voltage.
3	3	GND	Ground. Ground pins and exposed pad must be connected externally.
4	4	BIAS	Bias Supply. The bias supply is the power supply for the internal circuitry of the regulator.
5	5	EN	Enable: TTL/CMOS compatible input. Logic high = enable, logic low or open = shutdown
6 (Fixed)	6 (Fixed)	FB	Feedback Input. Connect to OUT. Optimum load regulation is obtained when feedback is taken from the actual load point.
6 (Adj)	6 (Adj)	ADJ	Adjust Input. Connect external resistor divider to program output voltage.
7,8	7,8	OUT	Output. Output Voltage of Regulator

Absolute Maximum Ratings⁽¹⁾

Input Supply Voltage (V_{IN}).....	0V to +4V
Bias Supply Voltage (V_{BIAS}).....	0V to +6V
Enable Voltage (V_{EN}).....	0V to +6V
Power Dissipation, Internally Limited ⁽³⁾	
Lead Temperature (soldering, #sec.).....	260°C
Storage Temperature (T_s).....	-65°C to +150°C
ESD Rating ⁽⁴⁾	2kV

Operating Ratings⁽²⁾

Input Supply Voltage (V_{IN}).....	1.0V to +3.6V
Bias Supply Voltage (V_{BIAS}).....	2.3V to +5.5V
Enable Input Voltage (V_{EN}).....	0V to V_{BIAS}
Junction Temperature (T_J).....	-40°C to +125°C
Junction Thermal Resistance	
ePad MSOP-8 (θ_{JA}).....	64°C/W
2mm x 2mm MLF [®] (θ_{JA}).....	90°C/W

Electrical Characteristics⁽⁵⁾

$V_{IN} = V_{OUT} + 0.5V$; $V_{BIAS} = V_{OUT} + 2.1V$, $I_{OUT} = 100\mu A$; $T_A = 25^\circ C$, bold values indicate $-40^\circ C \leq T_A \leq +125^\circ C$, unless noted.

Parameter	Condition	Min	Typ	Max	Units
UVLO Thresholds ⁽⁶⁾	Bias Supply Input Supply	1.9 0.7	2.1 0.85	2.3 1.0	V
UVLO Hysteresis	V_{BIAS} V_{IN}		70 25		mV
Output Voltage Accuracy	Variation from nominal V_{OUT}	-1.5		+1.5	%
	Variation from nominal V_{OUT} ; -40°C to +125°C	-2.0		+2.0	%
Output Voltage Line Regulation (Bias Supply)	$V_{BIAS} = V_{OUT} + 2.1V$ to 5.5V	-0.1	0.015	0.1	%/V
Output Voltage Line Regulation (Input Supply)	$V_{IN} = V_{OUT} + 0.5V$ to 3.6V	-0.05	0.005	0.05	%/V
Load Regulation	$I_{OUT} = 10mA$ to 1A		0.2	0.5	%
Input Supply Dropout Voltage	$I_{OUT} = 100mA$; $I_{OUT} = 500mA$; $I_{OUT} = 1A$;		8.5	50	mV
			37	250	mV
			80		mV
Bias Supply Dropout Voltage	$I_{OUT} = 100mA$; $I_{OUT} = 500mA$; $I_{OUT} = 1A$		1.15		V
			1.25		V
			1.35	2.1	V
Ground current from V_{BIAS}	$I_{OUT} = 1mA$ $I_{OUT} = 1A$		350	500	μA
			350	500	μA
Shutdown current from V_{BIAS}	$EN \leq 0.2V$		0.1	1.0	μA
Ground current from V_{IN}	$I_{OUT} = 1A$		6		μA
Shutdown current from V_{IN}	$EN \leq 0.2V$		0.1	1.0	μA
Ripple Rejection	$f = 1kHz$; $C_{OUT} = 1.0\mu F$; $I_{OUT} = 100mA$ $f = 100kHz$; $C_{OUT} = 1.0\mu F$; $I_{OUT} = 100mA$ $f = 500kHz$; $C_{OUT} = 1.0\mu F$; $I_{OUT} = 100mA$		80		dB
			55		dB
			45		dB

Parameter	Condition	Min	Typ	Max	Units
Current Limit	$V_{IN} = 2.7V$; $V_{OUT} = 0V$	1.1	1.6	2.5	A
Output Voltage Noise	$C_{OUT} = 1\mu F$; 10Hz to 100kHz; $I_{OUT} = 100mA$		63		μV_{RMS}
Over-temperature Shutdown			160		$^{\circ}C$
Over-temperature Shutdown Hysteresis			20		$^{\circ}C$
Enable Inputs					
Enable Voltage	Logic Low			0.2	V
	Logic High	1.0			V
Enable Input Current	$V_{IL} \leq 0.2V$		1		μA
	$V_{IH} = 1.2V$		6		μA
Turn-on Time	$C_{OUT} = 1\mu F$; 90% of typical V_{OUT}		35	500	μs
Reference Voltage (Adjustable Option Only)					
Reference Voltage		0.69	0.7	0.71	V
		0.686		0.714	V
ADJ pin Input current			20		nA

Notes:

- Exceeding the absolute maximum rating may damage the device.
- The device is not guaranteed to function outside its operating rating.
- The maximum allowable power dissipation of any T_A (ambient temperature) is $P_{D(max)} = T_{J(max)} - T_A / \theta_{JA}$. Exceeding the maximum allowable power dissipation will result in excessive die temperature, and the regulator will go into thermal shutdown.
- Devices are ESD sensitive. Handling precautions recommended. Human body model, 1.5k Ω in series with 100pF.
- Specification for packaged product only.
- Both UVLO thresholds must be met for the output voltage to be allowed to turn-on. If either of the two input voltages are below the UVLO thresholds, the output is kept off.

Typical Characteristics

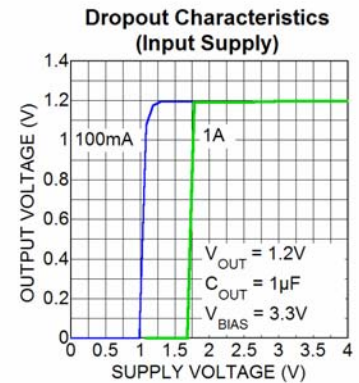
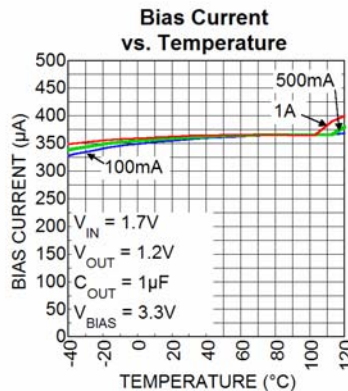
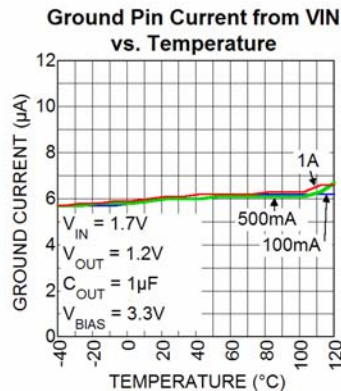
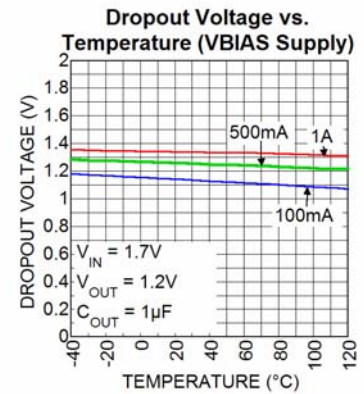
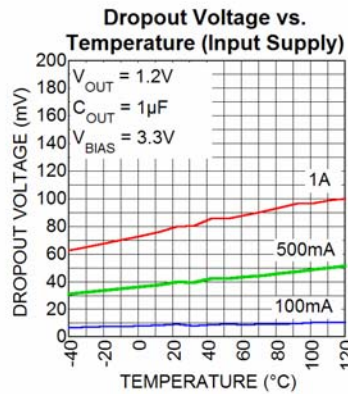
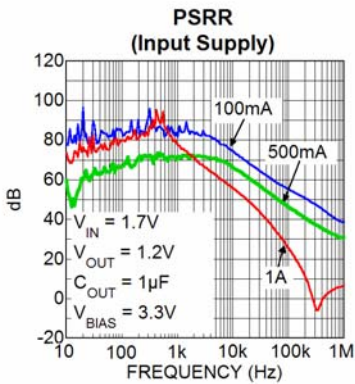
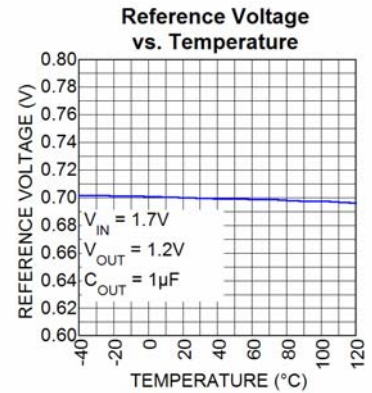
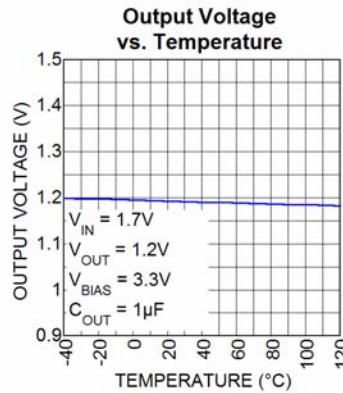
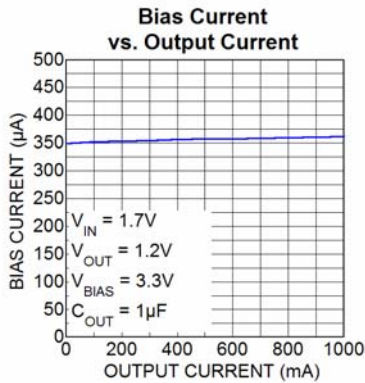
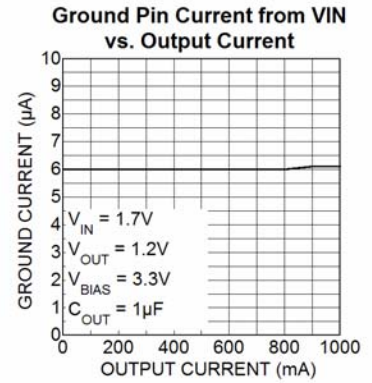
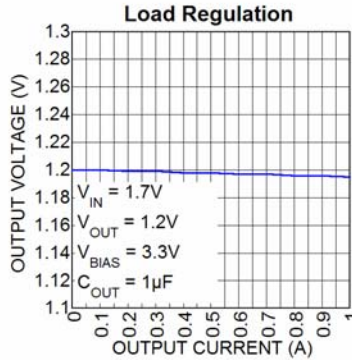
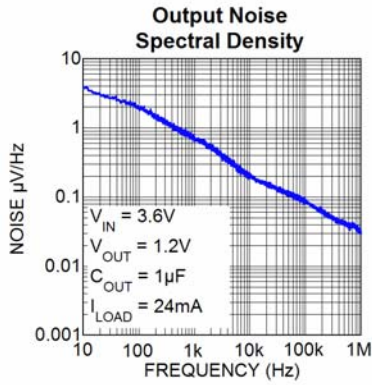

Typical Characteristics (continued)

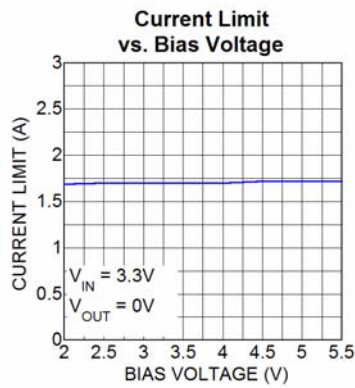
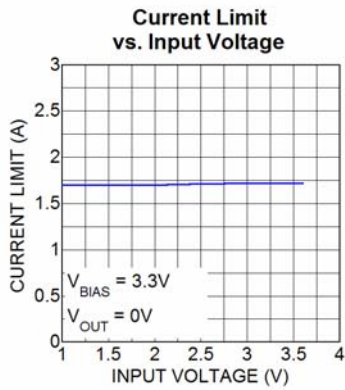
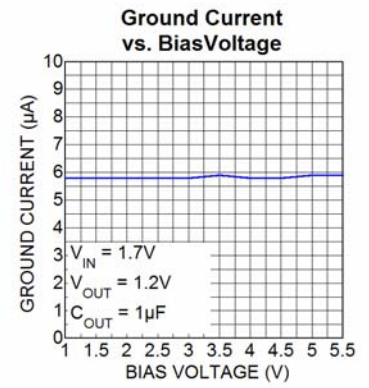
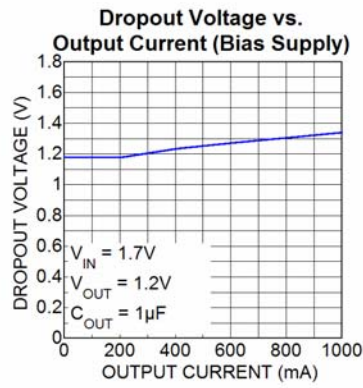
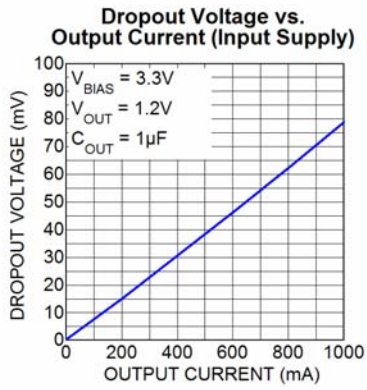

Functional Characteristics

Line Transient (V_{IN})

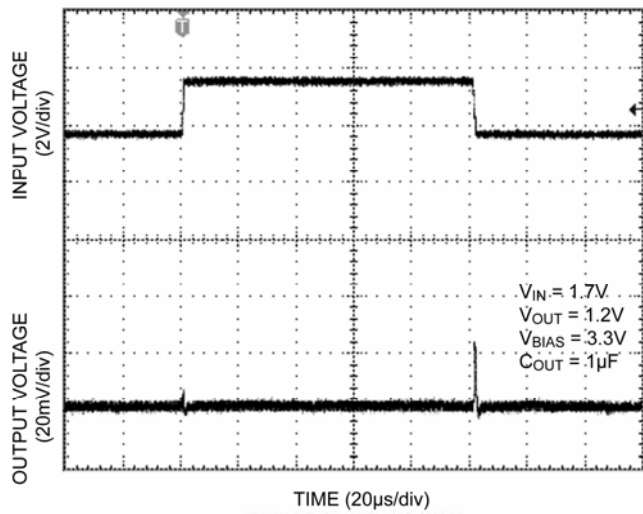

Load Transient

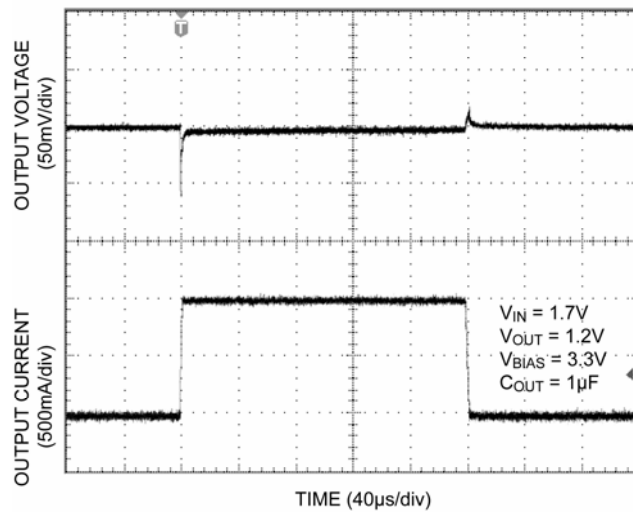

Enable Turn-On

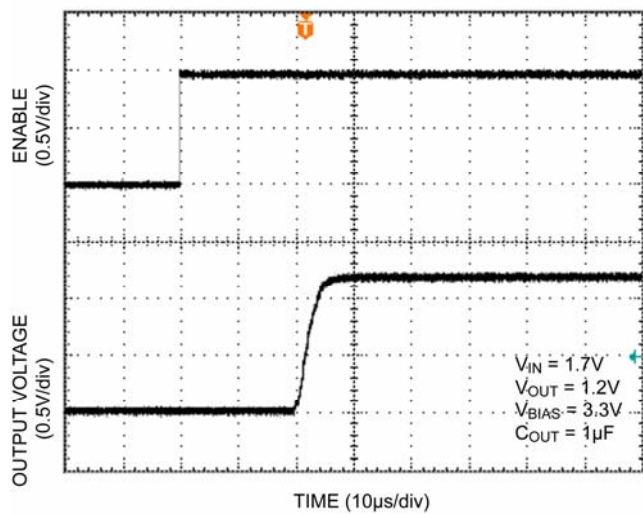

Functional Diagram

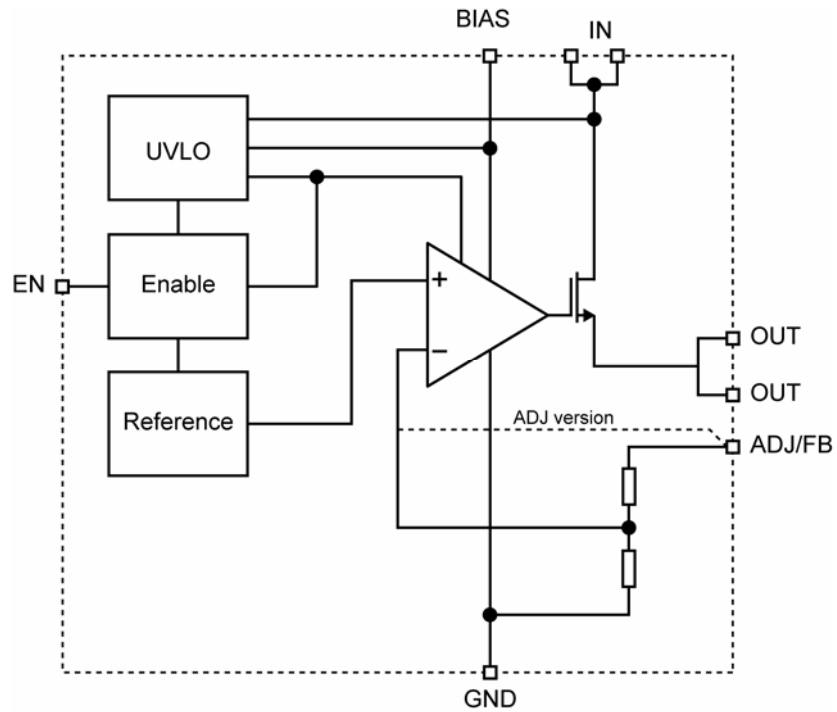

MIC47100 Block Diagram

Applications Information

The MIC47100 is a high speed, dual supply NMOS LDO designed to take advantage of point-of-load applications that use multiple supply rails to generate a low voltage, high current power supply. The MIC47100 can source 1A of output current while only requiring a 1 μ F ceramic output capacitor for stability.

The MIC47100 regulator is fully protected from damage due to fault conditions, offering linear current limiting and thermal shutdown.

Bias Supply Voltage

V_{BIAS} , requiring relatively light current, provides power to the control portion of the MIC47100. Bypassing on the bias pin is recommended to improve performance of the regulator during line and load transients. Small ceramic capacitors from V_{BIAS} -to-ground help reduce high frequency noise from being injected into the control circuitry from the bias rail and are good design practice.

Input Supply Voltage

V_{IN} provides the supply to power the LDO. The minimum input voltage is 1V, allowing conversion from low voltage supplies.

Output Capacitor

The MIC47100 requires an output capacitor of 1 μ F or greater to maintain stability. The design is optimized for use with low-ESR ceramic chip capacitors. High ESR capacitors may cause high frequency oscillation. The output capacitor can be increased, but performance has been optimized for a 1 μ F ceramic output capacitor and does not improve significantly with larger capacitance.

X7R/X5R dielectric-type ceramic capacitors are recommended because of their temperature performance. X7R-type capacitors change capacitance by 15% over their operating temperature range and are the most stable type of ceramic capacitors. Z5U and Y5V dielectric capacitors change value by as much as 50% and 60%, respectively, over their operating temperature ranges. To use a ceramic chip capacitor with Y5V dielectric, the value must be much higher than an X7R ceramic capacitor to ensure the same minimum capacitance over the equivalent operating temperature range.

Input Capacitor

The MIC47100 is a high-performance, high bandwidth device. Therefore, it requires a well-bypassed input supply for optimal performance. A 1 μ F capacitor is required from the input to ground to provide stability. Low-ESR ceramic capacitors provide optimal performance at a minimum of space. Additional high-

frequency capacitors, such as small-valued NPO dielectric-type capacitors, help filter out high-frequency noise and are good practice in any RF-based circuit.

Minimum Load Current

The MIC47100, unlike most other regulators, does not require a minimum load to maintain output voltage regulation.

Adjustable Regulator Design

The MIC47100 adjustable version allows programming the output voltage anywhere between 0.8V and 2.0V. Two resistors are used. The R1 resistor value between V_{OUT} and the adjust pin should not exceed 10k Ω . Larger values can cause instability. R2 connects between the adjust pin and ground. The resistor values are calculated by:

$$R1 = R2 \times \left(\frac{V_{OUT}}{0.7} - 1 \right)$$

Where V_{OUT} is the desired output voltage.

Enable/Shutdown

The MIC47100 comes with a single active-high enable pin that allows the regulator to be disabled. Forcing the enable pin low disables the regulator and sends it into a "zero" off-mode-current state. In this state, current consumed by the regulator goes nearly to zero. Forcing the enable pin high enables the output voltage. The active-high enable pin uses CMOS technology and the enable pin cannot be left floating; a floating enable pin may cause an indeterminate state on the output.

Thermal Considerations

The MIC47100 is designed to provide 1A of continuous current in a very small package. Maximum ambient operating temperature can be calculated based on the output current and the voltage drop across the part. Given that the input voltage is 1.8V, the output voltage is 1.2V and the output current is 1A. The actual power dissipation of the regulator circuit can be determined using the equation:

$$P_D = (V_{IN} - V_{OUT1}) I_{OUT} + V_{BIAS} I_{GND}$$

Because this device is CMOS, the ground current is insignificant for power dissipation and can be ignored for this calculation.

$$P_D = (1.8V - 1.2V) \times 1A$$

$$P_D = 0.6W$$

To determine the maximum ambient operating

temperature of the package, use the junction-to-ambient thermal resistance of the device and the following basic equation:

$$P_{D(MAX)} = \left(\frac{T_{J(MAX)} - T_A}{\theta_{JA}} \right)$$

$T_{J(max)} = 125^{\circ}\text{C}$, the maximum junction temperature of the die θ_{JA} thermal resistance = 90°C/W .

The table below shows junction-to-ambient thermal resistance for the MIC47100 in the MLF[®] package.

Package	θ_{JA} Recommended Minimum Footprint	θ_{JC}
8-pin 2mm x 2mm MLF [®]	90°C/W	2°C/W

Thermal Resistance

Substituting P_D for $P_{D(max)}$ and solving for the ambient operating temperature will give the maximum operating conditions for the regulator circuit. The junction-to-ambient thermal resistance for the minimum footprint is 90°C/W .

The maximum power dissipation must not be exceeded for proper operation.

For example, when operating the MIC47100-1.2YML at an input voltage of 1.8V and a 1A load with a minimum footprint layout, the maximum ambient operating temperature T_A can be determined as follows:

$$0.6\text{W} = \frac{(125^{\circ}\text{C} - T_A)}{(90^{\circ}\text{C/W})}$$

$$T_A = 71^{\circ}\text{C}$$

Therefore, a 1.2V application with 1A of output current can accept an ambient operating temperature of 71°C in a 2mm x 2mm MLF[®] package. For a full discussion of heat sinking and thermal effects on voltage regulators, refer to the "Regulator Thermals" section of *Micrel's Designing with Low-Dropout Voltage Regulators* handbook. This information can be found on Micrel's website at:

http://www.micrel.com/_PDF/other/LDOBk_ds.pdf

Package Information

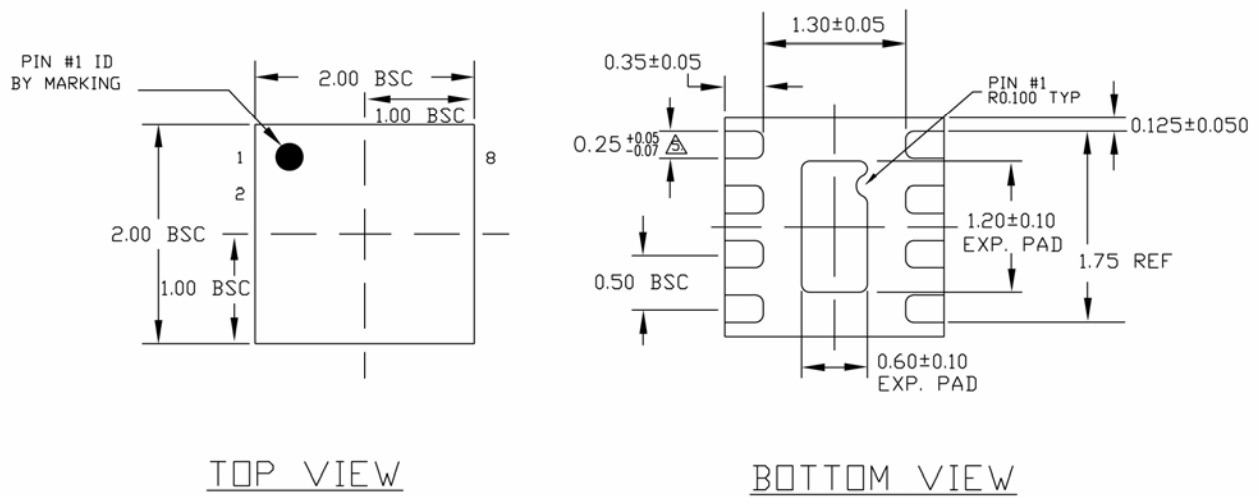

TOP VIEW

BOTTOM VIEW

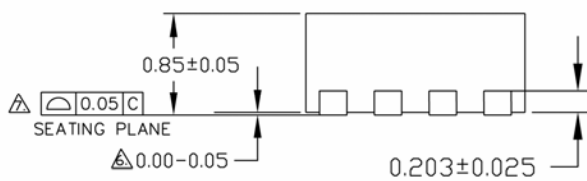

SIDE VIEW

NOTE:

1. ALL DIMENSIONS ARE IN MILLIMETERS.
 2. MAX. PACKAGE WARPAGE IS 0.05 mm.
 3. MAXIMUM ALLOWABLE BURRS IS 0.076 mm IN ALL DIRECTIONS.
 4. PIN #1 ID ON TOP WILL BE LASER/INK MARKED.
- △ DIMENSION APPLIES TO METALIZED TERMINAL AND IS MEASURED BETWEEN 0.20 AND 0.25 mm FROM TERMINAL TIP.
- △ APPLIED ONLY FOR TERMINALS.
- △ APPLIED FOR EXPOSED PAD AND TERMINALS.

8-Pin 2mmx2mm MLF (ML)

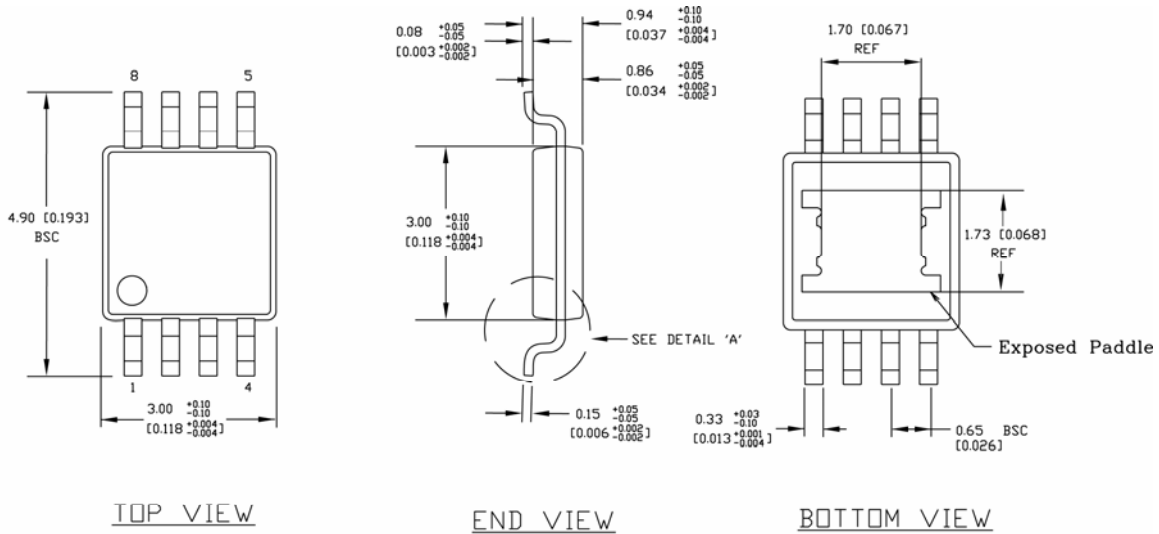

- NOTES:**
 1. DIMENSIONS ARE IN MM [INCHES].
 2. CONTROLLING DIMENSION: MM.
 3. DIMENSION DOES NOT INCLUDE MOLD FLASH OR PROTRUSIONS, EITHER OF WHICH SHALL NOT EXCEED 0.20 [0.008] PER SIDE.

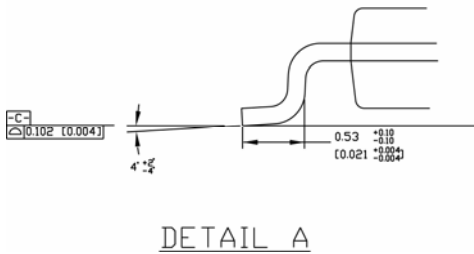

8-Pin e-MSOP (MME)

MICREL, INC. 2180 FORTUNE DRIVE SAN JOSE, CA 95131 USA
 TEL +1 (408) 944-0800 FAX +1 (408) 474-1000 WEB <http://www.micrel.com>

The information furnished by Micrel in this data sheet is believed to be accurate and reliable. However, no responsibility is assumed by Micrel for its use. Micrel reserves the right to change circuitry and specifications at any time without notification to the customer.

Micrel Products are not designed or authorized for use as components in life support appliances, devices or systems where malfunction of a product can reasonably be expected to result in personal injury. Life support devices or systems are devices or systems that (a) are intended for surgical implant into the body or (b) support or sustain life, and whose failure to perform can be reasonably expected to result in a significant injury to the user. A Purchaser's use or sale of Micrel Products for use in life support appliances, devices or systems is a Purchaser's own risk and Purchaser agrees to fully indemnify Micrel for any damages resulting from such use or sale.

© 2008 Micrel, Incorporated.

Mouser Electronics

Authorized Distributor

Click to View Pricing, Inventory, Delivery & Lifecycle Information:

Micrel:

[MIC47100YMME TR](#) [MIC47100-1.2YML TR](#)

Microchip:

[MIC47100-10YMME](#) [MIC47100YMME](#) [MIC47100-12YMME](#) [MIC47100-08YMME](#) [MIC47100YMME-TR](#) [MIC47100-1.2YML-TR](#) [MIC47100-1.0YML-TR](#) [MIC47100-08YMME-TR](#) [MIC47100-12YMME-TR](#) [MIC47100-0.8YML-TR](#)
[MIC47100YML-TR](#) [MIC47100-10YMME-TR](#)