

Chip Multilayer Ceramic Capacitors for General

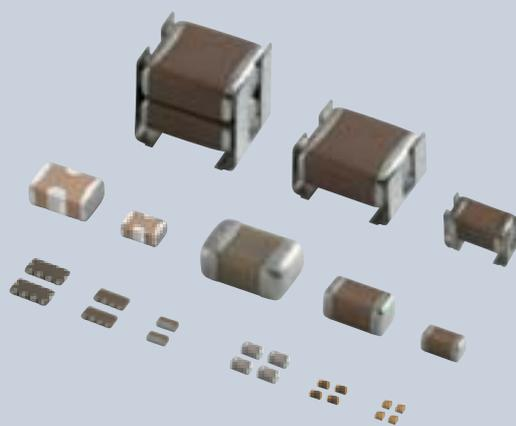

2018

Explanation of Symbols in This Catalog



Links are provided to the latest information from the PDF version of the catalog, which is available on the web.

General	For applications that do not require the particular reliability such as the general equipment
Info-tainment	Infotainment for Automotive The product for entertainment equipment like car navigations, car audios, and body control equipment like wipers, power windows.
Powertrain	Powertrain/Safety for Automotive Product used for applications (running, turning, stopping and safety devices) which particularly concern human life, such as in devices for automobiles.
Medical Device	Medical-grade products for Implanted Medical Devices These products are intended for use in implanted medical devices such as cardiac pacemakers, cochlear implants, insulin pumps and gastric electrostimulators. They are suitable for use in non-critical circuits. *1 *1 Non-critical circuits This term refers to circuits in implanted medical devices that are not directly linked to life support, i.e. circuits that will not directly endanger the life of the patient should the functionality of the device be reduced or halted by failure of the circuit.
AEC-Q200	AEC-Q200 compliant product
Safety standard	Safety Standard Certified Product Products that acquired safety standard certification IEC60384-14 and products based on the Electrical Appliance and Material Safety Law of Japan.
Japanese Safety Law	Based on the Electrical Appliance and Material Safety Law of Japan Products that are based on the electrical appliance and material safety law of Japan.
High Q	Low dissipation for high frequency By devising ceramic materials and electrode materials, low dissipation is achieved in frequency bands of VHF, UHF and microwave or beyond.
Low ESL	Low inductance This capacitor is designed so that the parasitic inductance component (ESL) that the capacitor has on the high frequency side becomes lower.
Fail safe	Fail safe product This capacitor is designed to prevent failures as much as possible by short mode.
Deflecting crack	Product resistant to deflection cracking This capacitor is designed to prevent failures as much as possible by short mode caused by cracking when there is board deflection.
Soldering crack	Product with solder cracking suppression "This capacitor is configured with metal terminals and leads connected to the chip. The metal terminals and leads relieve the stress from expansion and contraction of the solder, to suppress solder cracking."
Anti-noise	Product suitable for acoustic noise reduction and low distortion This product suppresses acoustic noise, which occurs when a ceramic capacitor is used, by devising the materials and configuration.
Effective Cap	No DC bias characteristics Polymer capacitor is no capacitance change with DC bias due to aluminum oxidized film for dielectric.
EMI FIL®	Low-inductance product suitable for noise suppression. This product has extremely low ESL and is suitable for suppression of noise, including high frequencies. This product can also be used as a low-ESL, high-performance bypass capacitor.
Bonding	Product for bonding Since gold is used for the external electrodes, the capacitor can be mounted by die bonding/wire bonding.

Derating 1
 This product is suitable when a voltage continuously applied to a capacitor in an operating circuit, is used below (derated) the rated voltage of the capacitor. This model guarantees the test conditions in the endurance test, at a rated voltage x 100% at the maximum operating temperature. A reliability assurance level equivalent to a common product can be secured, by using this product within the voltage and temperature derated conditions recommended in the figure below.

D1
 Derating 1

Recommended Conditions of the Derating Operating Voltage and Temperature

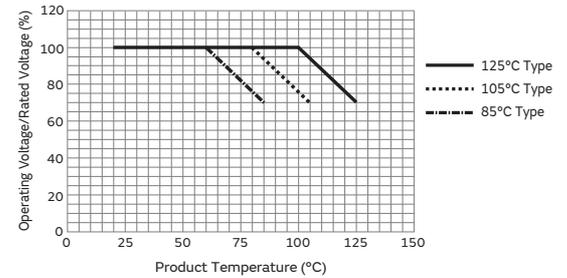

Derating 2
 When the product temperature exceeds 105°C, please use this product within the voltage and temperature derated conditions in the figure below.

D2
 Derating 2

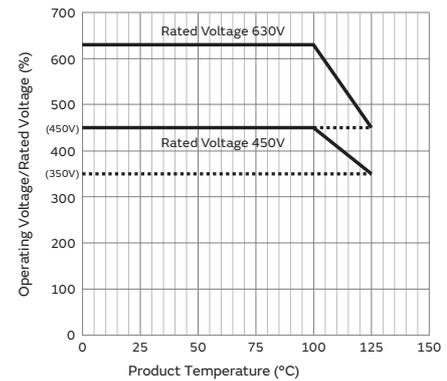

Derating 3
 Please apply the derating curve according to the operating temperature.
 Please refer to detailed specifications sheet for details.

D3
 Derating 3

Derating 4
 When the product temperature exceeds 125°C, please use this product within the voltage and temperature derated conditions in the figure below.

D4
 Derating 4

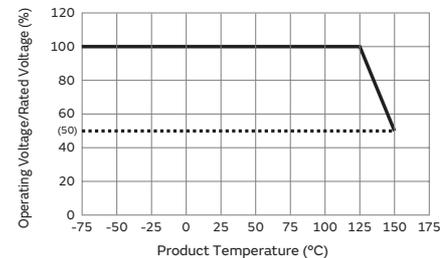

Derating 5
 Please apply the rated voltage derating over 150 °C.
 Please refer to detailed specifications sheet for details.

D5
 Derating 5

Selection Guide for Capacitors

For general

General SMD

Solder mounting

Chip type

	GRM		p40	
	GRM	For LCD backlight inverter circuit only		WEB
	GR3	Anti-noise	High effective capacitance & high ripple current	p109
	GRJ	Deflecting crack	Soft termination	p120
	GXM	Water Repellent		WEB
	GR4		For information devices only	p125
	GR7		For camera flash circuit only	p130
	GJM	High Q		p135
	GQM	High Q	High power	p164
	GA2	Japanese Safety Law	Based on the Electrical Appliance and Material Safety Law of Japan	p184
	GA3	Safety standard		p189
	LLL	Low ESL	LW reversed	p219
	LLA	Low ESL	8 terminals	p222
	LLM	Low ESL	10 terminals	p228
	LLR	Low ESL	LW reversed controlled ESR	p232
	NFM	Low ESL	3 terminals	p236
	GJ4	Anti-noise	Low distortion	WEB
	GJ8	Anti-noise	Low acoustic noise	WEB

On interposer board

	ZRA	Anti-noise		WEB
	ZRB	Anti-noise		WEB

Metal terminal type

	KRM	Anti-noise	Deflecting crack	Soldering crack		p239
	KR3	Anti-noise	Deflecting crack	Soldering crack	High effective capacitance & high ripple current	p243

Resin molding SMD type

	DK1	Safety standard		WEB
--	------------	-----------------	--	-----

Wire bonding mounting

Chip type

	GMA		Microchip	p249
	GMD			p256

Lead type

Solder mounting

	RDE	Anti-noise	Deflecting crack	Soldering crack		WEB
	DEH		High temperature low loss			WEB
	DEA		High temperature Class 1			WEB
	DEB		Class 2			WEB
	DEC					WEB
	DEF		For LCD backlight inverter circuit only			WEB
	DHR	Ultra-high voltage	Deflecting crack	Soldering crack		WEB
	DEJ	Japanese Safety Law	Based on the Electrical Appliance and Material Safety Law of Japan			WEB
	DE1	Safety standard	X1/Y1 Class certified product			WEB
	DE2	Safety standard	X1/Y2 Class certified product			WEB

Screw termination mounting

	DHS	Ultra-high voltage		WEB
	DHK	Ultra-high voltage	High voltage AC rated	WEB

Infotainment for automotive

SMD

Solder mounting

Chip type

	GRT			WEB
--	------------	--	--	-----

Powertrain/Safety for automotive

SMD

Solder mounting

Chip type

	GCM			WEB		
	GC3	Anti-noise	High effective capacitance & high ripple current	WEB		
	GCJ	Fail safe	Deflecting crack	Soft termination	WEB	
	GGM	Water Repellent		WEB		
	GCQ	High Q		WEB		
	GCD	Fail safe	Deflecting crack	MLSC design	WEB	
	GCE	Fail safe	Deflecting crack	Soft termination MLSC design	WEB	
	GGD	Fail safe	Deflecting crack	Water Repellent	MLSC design	WEB
	NFM	Low ESL		3 terminals	WEB	

Metal terminal type

	KCM	Anti-noise	Deflecting crack	Soldering crack		WEB
	KC3	Anti-noise	Deflecting crack	Soldering crack	High effective capacitance & high ripple current	WEB
	KCA	Safety standard	Anti-noise	Deflecting crack	Soldering crack	WEB

Limited to Conductive Glue Mounting

Chip type

	GCB	Deflecting crack	Soldering crack	Ni plating + Pd plating termination conductive glue mounting	WEB
	GCG	Deflecting crack	Soldering crack	AgPd termination conductive glue mounting	WEB

Lead type

Solder mounting

	RCE	Anti-noise	Deflecting crack	Soldering crack		WEB
	RHE	Anti-noise	Deflecting crack	Soldering crack	150°C operation leaded	WEB
	RHS	Anti-noise	Deflecting crack	Soldering crack	200°C operation leaded	WEB
	DE6	Safety standard				WEB

Medical-grade products for implanted medical devices

Medical Device SMD

Solder mounting

Chip type

	GCH			WEB
--	------------	--	--	-----

● Part Numbering

Chip Multilayer Ceramic Capacitors for General



(Part Number)

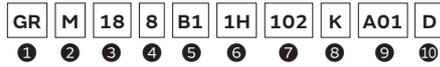

① Product ID ② Series

Product ID	Code	Series
GA	2	Based on the Electrical Appliance and Material Safety Law of Japan Chip Multilayer Ceramic Capacitors for General Purpose
	3	Safety Standard Certified Chip Multilayer Ceramic Capacitors for General Purpose
GJ	M	High Q Chip Multilayer Ceramic Capacitors for General Purpose
GM	A	Wire Bonding Mount Multilayer Microchip Capacitors for General Purpose
	D	Wire Bonding/AuSn Soldering Mount Chip Multilayer Ceramic Capacitors for General Purpose
GQ	M	High Q and High Power Chip Multilayer Ceramic Capacitors for General Purpose
GR	3	High Effective Capacitance & High Ripple Current Chip Multilayer Ceramic Capacitors for General Purpose
	4	Chip Multilayer Ceramic Capacitors for Camera Flash Circuit only
	7	Chip Multilayer Ceramic Capacitors for Ethernet LAN and Primary-secondary Coupling of DC-DC Converters
	J	Soft Termination Chip Multilayer Ceramic Capacitors for General Purpose
KR	M	Chip Multilayer Ceramic Capacitors for General Purpose
	3	High Effective Capacitance & High Allowable Ripple Current Metal Terminal Type Multilayer Ceramic Capacitors for General Purpose
LL	M	Metal Terminal Type Multilayer Ceramic Capacitors for General Purpose
	A	8 Terminals Low ESL Chip Multilayer Ceramic Capacitors for General Purpose
	L	LW Reversed Low ESL Chip Multilayer Ceramic Capacitors for General Purpose
	M	10 Terminals Low ESL Chip Multilayer Ceramic Capacitors for General Purpose
	R	LW Reversed Controlled ESR Low ESL Chip Multilayer Ceramic Capacitors for General Purpose

③ Chip Dimensions (LxW)

Code	Dimensions (LxW)	EIA
02	0.4x0.2mm	01005
0D	0.38x0.38mm	015015
03	0.6x0.3mm	0201
05	0.5x0.5mm	0202
08	0.8x0.8mm	0303
1U	0.6x1.0mm	02404
15	1.0x0.5mm	0402
18	1.6x0.8mm	0603
21	2.0x1.25mm	0805
22	2.8x2.8mm	1111
31	3.2x1.6mm	1206
32	3.2x2.5mm	1210
42	4.5x2.0mm	1808
43	4.5x3.2mm	1812
52	5.7x2.8mm	2211
55	5.7x5.0mm	2220

Continued on the following page. ↗

(Part Number)

GR	M	18	8	B1	1H	102	K	A01	D
1	2	3	4	5	6	7	8	9	10

Continued from the preceding page. ↘

④ Height Dimension (T) (Except KR□)

Code	Dimension (T)
2	0.2mm
3	0.3mm
4	0.4mm
5	0.5mm
6	0.6mm
7	0.7mm
8	0.8mm
9	0.85mm
A	1.0mm
B	1.25mm
C	1.6mm
D	2.0mm
E	2.5mm
M	1.15mm
Q	1.5mm
X	Depends on individual standards.

④ Height Dimension (T) (KR□ Only)

Code	Dimension (T)
E	1.8mm
F	1.9mm
K	2.7mm
L	2.8mm
Q	3.7mm
T	4.8mm
W	6.4mm

⑤ Temperature Characteristics

Temperature Characteristic Codes			Temperature Characteristics				Operating Temperature Range	Capacitance Change Each Temperature (%)					
Code	Public STD Code	Reference Temperature	Temperature Range	Capacitance Change or Temperature Coefficient	-55°C			*6		-10°C			
					Max.	Min.		Max.	Min.	Max.	Min.		
1X	SL	JIS	20°C	20 to 85°C	+350 to -1000ppm/°C	-55 to 125°C	-	-	-	-	-	-	
2C	CH	JIS	20°C	20 to 125°C	0±60ppm/°C	-55 to 125°C	0.82	-0.45	0.49	-0.27	0.33	-0.18	
3C	CJ	JIS	20°C	20 to 125°C	0±120ppm/°C	-55 to 125°C	1.37	-0.9	0.82	-0.54	0.55	-0.36	
3U	UJ	JIS	20°C	20 to 85°C	-750±120ppm/°C	-25 to 85°C	-	-	4.94	2.84	3.29	1.89	
4C	CK	JIS	20°C	20 to 125°C	0±250ppm/°C	-55 to 125°C	2.56	-1.88	1.54	-1.13	1.02	-0.75	
5C	C0G	EIA	25°C	25 to 125°C	0±30ppm/°C	-55 to 125°C	0.58	-0.24	0.4	-0.17	0.25	-0.11	
5G	X8G	*2	25°C	25 to 150°C	0±30ppm/°C	-55 to 150°C	0.58	-0.24	0.4	-0.17	0.25	-0.11	
7U	U2J	EIA	25°C	25 to 125°C *3	-750±120ppm/°C	-55 to 125°C	8.78	5.04	6.04	3.47	3.84	2.21	
B1	B *1	JIS	20°C	-25 to 85°C	±10%	-25 to 85°C	-	-	-	-	-	-	
B3	B	JIS	20°C	-25 to 85°C	±10%	-25 to 85°C	-	-	-	-	-	-	
C7	X7S	EIA	25°C	-55 to 125°C	±22%	-55 to 125°C	-	-	-	-	-	-	
C8	X6S	EIA	25°C	-55 to 105°C	±22%	-55 to 105°C	-	-	-	-	-	-	
D7	X7T	EIA	25°C	-55 to 125°C	+22%, -33%	-55 to 125°C	-	-	-	-	-	-	
D8	X6T	EIA	25°C	-55 to 105°C	+22%, -33%	-55 to 105°C	-	-	-	-	-	-	
E7	X7U	EIA	25°C	-55 to 125°C	+22%, -56%	-55 to 125°C	-	-	-	-	-	-	
R1	R *1	JIS	20°C	-55 to 125°C	±15%	-55 to 125°C	-	-	-	-	-	-	
R6	X5R	EIA	25°C	-55 to 85°C	±15%	-55 to 85°C	-	-	-	-	-	-	
R7	X7R	EIA	25°C	-55 to 125°C	±15%	-55 to 125°C	-	-	-	-	-	-	
W0	X7T	EIA	25°C	-55 to 125°C	±10% *4	-55 to 125°C	-	-	-	-	-	-	
					+22%, -33% *5		-	-	-	-	-	-	

*1 Capacitance change is specified with 50% rated voltage applied.
 *2 Murata Temperature Characteristic Code.
 *3 Rated Voltage 100Vdc max: 25 to 85°C
 *4 Apply DC350V bias.
 *5 No DC bias.
 *6 -25°C (Reference Temperature 20°C) / -30°C (Reference Temperature 25°C)

Continued on the following page. ↗

(Part Number)

GR	M	18	8	B1	1H	102	K	A01	D
1	2	3	4	5	6	7	8	9	10

Continued from the preceding page. ↘

⑥ Rated Voltage

Code	Rated Voltage
OE	DC2.5V
OG	DC4V
OJ	DC6.3V
1A	DC10V
1C	DC16V
1E	DC25V
1H	DC50V
1J	DC63V
1K	DC80V
2A	DC100V
2D	DC200V
2E	DC250V
2W	DC450V
2H	DC500V
2J	DC630V
3A	DC1kV
3D	DC2kV
3F	DC3.15kV
BB	DC350V
E2	AC250V
GB	X2; AC250V (Safety Standard Certified Type GB)
GD	Y3; AC250V (Safety Standard Certified Type GD)
GF	Y2, X1/Y2; AC250V (Safety Standard Certified Type GF)
YA	DC35V

⑦ Capacitance

Expressed by three-digit alphanumerics. The unit is picofarad (pF). The first and second figures are significant digits, and the third figure expresses the number of zeros which follow the two numbers. If there is a decimal point, it is expressed by the capital letter "R." In this case, all figures are significant digits. If any alphabet, other than "R", is included, this indicates the specific part number is a non-standard part.

Ex.)

Code	Capacitance
R50	0.50pF
1R0	1.0pF
100	10pF
103	10000pF

⑧ Capacitance Tolerance

Code	Capacitance Tolerance
B	±0.1pF
C	±0.25pF
D	±0.5pF (Less than 10pF) ±0.5% (10pF and over)
F	±1%
G	±2%
J	±5%
K	±10%
M	±20%
W	±0.05pF

⑨ Individual Specification Code (Except LLR)

Expressed by three figures.

⑨ ESR (LLR Only)

Code	ESR
E01	100mΩ
E03	220mΩ
E05	470mΩ
E07	1000mΩ

⑩ Packaging

Code	Packaging
L	ø180mm Embossed Taping
D/E/W	ø180mm Paper Taping
K	ø330mm Embossed Taping
J/F	ø330mm Paper Taping
T	Bulk Tray

Please contact us if you find any part number not provided in this table.

Chip Multilayer Ceramic Capacitors for General Purpose

GRM Series



This is Murata primary products renowned for both small size and large capacitance value with latest advanced technology.

Features

① Achieves large-capacity and small size in a multilayer structure.

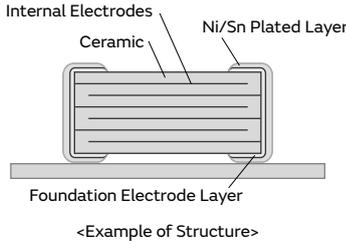

"Thin Layer Technology" for thinner layers

"Fine Particle Technology" for finer particles

"High Precision Lamination Technology" for more accuracy

② Sn plating is applied to the external electrodes; excellent solderability.

③ High reliability with no polarity.

	Ceramic Capacitors	Tantalum Capacitor	Aluminum Electrolytic Capacitor	Conductive Polymer Capacitor
Price	○	○	◎	○
Comparison between Impedance Frequency Characteristics	◎	△	△	○
Capacitance temperature characteristics	○	◎	○	○
DC breakdown voltage	◎	△	△	△
Polarity	No	Yes	Yes	Yes
Pulse response	◎	△	△	○
Allowable ripple current	◎	△	△	△
Reliability	◎	○	○	○
DC bias characteristics	△	◎	◎	◎

◎: Particularly excellent ○: Excellent △: Inferior

Specifications

Size (mm)	0.25×0.125mm to 5.7×5.0mm
Rated Voltage	2.5Vdc to 3150Vdc
Capacitance	0.10pF to 330µF
Main Applications	1. Rated voltage 100V Max. High Dielectric Constant Type . . . For decoupling and smoothing circuits Temperature Compensating Type . . . For tuning circuits, oscillating circuits, and high frequency filter circuits 2. Rated voltage 200V min. High Dielectric Constant Type . . . For clamp snubber circuits and smoothing circuits Temperature Compensating Type . . . Power supply damper snubber

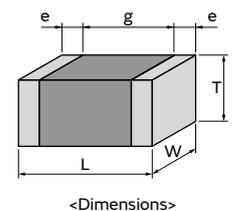

This catalog contains only a portion of the product lineup.
 Please refer to the capacitor search tool on the Murata Web site for details.

GRM
 GR3
 GRJ
 GR4
 GR7
 GJM
 GQM
 GA2
 GA3 GB
 GA3 GD
 GA3 GF
 LLL
 LLA
 LLM
 LLR
 NFM
 KRM
 KR3
 GMA
 GMD
 △Caution /Notice

GRM Series Temperature Compensating Type Part Number List

0.4×0.2mm

T max.	Rated Voltage	TC Code	Cap.	Tol.	Part Number
0.22mm	50Vdc	COG	0.20pF	±0.05pF	GRM0225C1HR20WA03#
				±0.1pF	GRM0225C1HR20BA03#
			0.30pF	±0.05pF	GRM0225C1HR30WA03#
				±0.1pF	GRM0225C1HR30BA03#
			0.40pF	±0.05pF	GRM0225C1HR40WA03#
				±0.1pF	GRM0225C1HR40BA03#
			0.50pF	±0.05pF	GRM0225C1HR50WA03#
				±0.1pF	GRM0225C1HR50BA03#
			0.60pF	±0.05pF	GRM0225C1HR60WA03#
				±0.1pF	GRM0225C1HR60BA03#
			0.70pF	±0.05pF	GRM0225C1HR70WA03#
				±0.1pF	GRM0225C1HR70BA03#
			0.80pF	±0.05pF	GRM0225C1HR80WA03#
				±0.1pF	GRM0225C1HR80BA03#
			0.90pF	±0.05pF	GRM0225C1HR90WA03#
				±0.1pF	GRM0225C1HR90BA03#
			1.0pF	±0.05pF	GRM0225C1H1R0WA03#
				±0.1pF	GRM0225C1H1R0BA03#
				±0.25pF	GRM0225C1H1R0CA03#
			1.1pF	±0.05pF	GRM0225C1H1R1WA03#
				±0.1pF	GRM0225C1H1R1BA03#
				±0.25pF	GRM0225C1H1R1CA03#
			1.2pF	±0.05pF	GRM0225C1H1R2WA03#
				±0.1pF	GRM0225C1H1R2BA03#
				±0.25pF	GRM0225C1H1R2CA03#
			1.3pF	±0.05pF	GRM0225C1H1R3WA03#
				±0.1pF	GRM0225C1H1R3BA03#
				±0.25pF	GRM0225C1H1R3CA03#
			1.4pF	±0.05pF	GRM0225C1H1R4WA03#
				±0.1pF	GRM0225C1H1R4BA03#
				±0.25pF	GRM0225C1H1R4CA03#
			1.5pF	±0.05pF	GRM0225C1H1R5WA03#
				±0.1pF	GRM0225C1H1R5BA03#
				±0.25pF	GRM0225C1H1R5CA03#
			1.6pF	±0.05pF	GRM0225C1H1R6WA03#
				±0.1pF	GRM0225C1H1R6BA03#
				±0.25pF	GRM0225C1H1R6CA03#
			1.7pF	±0.05pF	GRM0225C1H1R7WA03#
				±0.1pF	GRM0225C1H1R7BA03#
				±0.25pF	GRM0225C1H1R7CA03#
			1.8pF	±0.05pF	GRM0225C1H1R8WA03#
				±0.1pF	GRM0225C1H1R8BA03#
				±0.25pF	GRM0225C1H1R8CA03#
			1.9pF	±0.05pF	GRM0225C1H1R9WA03#
				±0.1pF	GRM0225C1H1R9BA03#
				±0.25pF	GRM0225C1H1R9CA03#
			2.0pF	±0.05pF	GRM0225C1H2R0WA03#
				±0.1pF	GRM0225C1H2R0BA03#
±0.25pF	GRM0225C1H2R0CA03#				
2.1pF	±0.05pF	GRM0225C1H2R1WA03#			
	±0.1pF	GRM0225C1H2R1BA03#			
	±0.25pF	GRM0225C1H2R1CA03#			

T max.	Rated Voltage	TC Code	Cap.	Tol.	Part Number
0.22mm	50Vdc	COG	2.2pF	±0.05pF	GRM0225C1H2R2WA03#
				±0.1pF	GRM0225C1H2R2BA03#
				±0.25pF	GRM0225C1H2R2CA03#
			2.3pF	±0.05pF	GRM0225C1H2R3WA03#
				±0.1pF	GRM0225C1H2R3BA03#
				±0.25pF	GRM0225C1H2R3CA03#
			2.4pF	±0.05pF	GRM0225C1H2R4WA03#
				±0.1pF	GRM0225C1H2R4BA03#
				±0.25pF	GRM0225C1H2R4CA03#
			2.5pF	±0.05pF	GRM0225C1H2R5WA03#
				±0.1pF	GRM0225C1H2R5BA03#
				±0.25pF	GRM0225C1H2R5CA03#
			2.6pF	±0.05pF	GRM0225C1H2R6WA03#
				±0.1pF	GRM0225C1H2R6BA03#
				±0.25pF	GRM0225C1H2R6CA03#
			2.7pF	±0.05pF	GRM0225C1H2R7WA03#
				±0.1pF	GRM0225C1H2R7BA03#
				±0.25pF	GRM0225C1H2R7CA03#
			2.8pF	±0.05pF	GRM0225C1H2R8WA03#
				±0.1pF	GRM0225C1H2R8BA03#
				±0.25pF	GRM0225C1H2R8CA03#
			2.9pF	±0.05pF	GRM0225C1H2R9WA03#
				±0.1pF	GRM0225C1H2R9BA03#
				±0.25pF	GRM0225C1H2R9CA03#
			3.0pF	±0.05pF	GRM0225C1H3R0WA03#
				±0.1pF	GRM0225C1H3R0BA03#
				±0.25pF	GRM0225C1H3R0CA03#
			3.1pF	±0.05pF	GRM0225C1H3R1WA03#
				±0.1pF	GRM0225C1H3R1BA03#
				±0.25pF	GRM0225C1H3R1CA03#
			3.2pF	±0.05pF	GRM0225C1H3R2WA03#
				±0.1pF	GRM0225C1H3R2BA03#
				±0.25pF	GRM0225C1H3R2CA03#
			3.3pF	±0.05pF	GRM0225C1H3R3WA03#
				±0.1pF	GRM0225C1H3R3BA03#
				±0.25pF	GRM0225C1H3R3CA03#
			3.4pF	±0.05pF	GRM0225C1H3R4WA03#
				±0.1pF	GRM0225C1H3R4BA03#
				±0.25pF	GRM0225C1H3R4CA03#
			3.5pF	±0.05pF	GRM0225C1H3R5WA03#
				±0.1pF	GRM0225C1H3R5BA03#
				±0.25pF	GRM0225C1H3R5CA03#
			3.6pF	±0.05pF	GRM0225C1H3R6WA03#
				±0.1pF	GRM0225C1H3R6BA03#
				±0.25pF	GRM0225C1H3R6CA03#
			3.7pF	±0.05pF	GRM0225C1H3R7WA03#
				±0.1pF	GRM0225C1H3R7BA03#
				±0.25pF	GRM0225C1H3R7CA03#
3.8pF	±0.05pF	GRM0225C1H3R8WA03#			
	±0.1pF	GRM0225C1H3R8BA03#			
	±0.25pF	GRM0225C1H3R8CA03#			
3.9pF	±0.05pF	GRM0225C1H3R9WA03#			
	±0.1pF	GRM0225C1H3R9BA03#			
	±0.25pF	GRM0225C1H3R9CA03#			

- GRM
- GR3
- GRJ
- GR4
- GR7
- GJM
- GQM
- GA2
- GA3 GB
- GA3 GD
- GA3 GF
- LLL
- LLA
- LLM
- LLR
- NFM
- KRM
- KR3
- GMA
- GMD
- ⚠Caution /Notice

Part number # indicates the package specification code.

GRM Series Temperature Compensating Type Part Number List

(→ 0.4×0.2mm)

T max.	Rated Voltage	TC Code	Cap.	Tol.	Part Number	T max.	Rated Voltage	TC Code	Cap.	Tol.	Part Number
0.22mm	50Vdc	COG	4.0pF	±0.05pF	GRM0225C1H4R0WA03#	0.22mm	50Vdc	COG	5.6pF	±0.1pF	GRM0225C1H5R6BA03#
				±0.1pF	GRM0225C1H4R0BA03#					±0.25pF	GRM0225C1H5R6CA03#
				±0.25pF	GRM0225C1H4R0CA03#					±0.5pF	GRM0225C1H5R6DA03#
			4.1pF	±0.05pF	GRM0225C1H4R1WA03#				5.7pF	±0.05pF	GRM0225C1H5R7WA03#
				±0.1pF	GRM0225C1H4R1BA03#					±0.1pF	GRM0225C1H5R7BA03#
				±0.25pF	GRM0225C1H4R1CA03#					±0.25pF	GRM0225C1H5R7CA03#
			4.2pF	±0.05pF	GRM0225C1H4R2WA03#				5.8pF	±0.05pF	GRM0225C1H5R8WA03#
				±0.1pF	GRM0225C1H4R2BA03#					±0.1pF	GRM0225C1H5R8BA03#
				±0.25pF	GRM0225C1H4R2CA03#					±0.25pF	GRM0225C1H5R8CA03#
			4.3pF	±0.05pF	GRM0225C1H4R3WA03#				5.9pF	±0.05pF	GRM0225C1H5R9WA03#
				±0.1pF	GRM0225C1H4R3BA03#					±0.1pF	GRM0225C1H5R9BA03#
				±0.25pF	GRM0225C1H4R3CA03#					±0.25pF	GRM0225C1H5R9CA03#
			4.4pF	±0.05pF	GRM0225C1H4R4WA03#				6.0pF	±0.05pF	GRM0225C1H6R0WA03#
				±0.1pF	GRM0225C1H4R4BA03#					±0.1pF	GRM0225C1H6R0BA03#
				±0.25pF	GRM0225C1H4R4CA03#					±0.25pF	GRM0225C1H6R0CA03#
			4.5pF	±0.05pF	GRM0225C1H4R5WA03#				6.1pF	±0.05pF	GRM0225C1H6R1WA03#
				±0.1pF	GRM0225C1H4R5BA03#					±0.1pF	GRM0225C1H6R1BA03#
				±0.25pF	GRM0225C1H4R5CA03#					±0.25pF	GRM0225C1H6R1CA03#
			4.6pF	±0.05pF	GRM0225C1H4R6WA03#				6.2pF	±0.05pF	GRM0225C1H6R2WA03#
				±0.1pF	GRM0225C1H4R6BA03#					±0.1pF	GRM0225C1H6R2BA03#
				±0.25pF	GRM0225C1H4R6CA03#					±0.25pF	GRM0225C1H6R2CA03#
			4.7pF	±0.05pF	GRM0225C1H4R7WA03#				6.3pF	±0.05pF	GRM0225C1H6R3WA03#
				±0.1pF	GRM0225C1H4R7BA03#					±0.1pF	GRM0225C1H6R3BA03#
				±0.25pF	GRM0225C1H4R7CA03#					±0.25pF	GRM0225C1H6R3CA03#
			4.8pF	±0.05pF	GRM0225C1H4R8WA03#				6.4pF	±0.05pF	GRM0225C1H6R4WA03#
				±0.1pF	GRM0225C1H4R8BA03#					±0.1pF	GRM0225C1H6R4BA03#
				±0.25pF	GRM0225C1H4R8CA03#					±0.25pF	GRM0225C1H6R4CA03#
			4.9pF	±0.05pF	GRM0225C1H4R9WA03#				6.5pF	±0.05pF	GRM0225C1H6R5WA03#
				±0.1pF	GRM0225C1H4R9BA03#					±0.1pF	GRM0225C1H6R5BA03#
				±0.25pF	GRM0225C1H4R9CA03#					±0.25pF	GRM0225C1H6R5CA03#
			5.0pF	±0.05pF	GRM0225C1H5R0WA03#				6.6pF	±0.05pF	GRM0225C1H6R6WA03#
				±0.1pF	GRM0225C1H5R0BA03#					±0.1pF	GRM0225C1H6R6BA03#
				±0.25pF	GRM0225C1H5R0CA03#					±0.25pF	GRM0225C1H6R6CA03#
			5.1pF	±0.05pF	GRM0225C1H5R1WA03#				6.7pF	±0.05pF	GRM0225C1H6R7WA03#
				±0.1pF	GRM0225C1H5R1BA03#					±0.1pF	GRM0225C1H6R7BA03#
				±0.25pF	GRM0225C1H5R1CA03#					±0.25pF	GRM0225C1H6R7CA03#
			5.2pF	±0.05pF	GRM0225C1H5R2WA03#				6.8pF	±0.05pF	GRM0225C1H6R8WA03#
				±0.1pF	GRM0225C1H5R2BA03#					±0.1pF	GRM0225C1H6R8BA03#
				±0.25pF	GRM0225C1H5R2CA03#					±0.25pF	GRM0225C1H6R8CA03#
			5.3pF	±0.05pF	GRM0225C1H5R3WA03#				6.9pF	±0.05pF	GRM0225C1H6R9WA03#
				±0.1pF	GRM0225C1H5R3BA03#					±0.1pF	GRM0225C1H6R9BA03#
				±0.25pF	GRM0225C1H5R3CA03#					±0.25pF	GRM0225C1H6R9CA03#
			5.4pF	±0.05pF	GRM0225C1H5R4WA03#					±0.5pF	GRM0225C1H5R5DA03#
				±0.1pF	GRM0225C1H5R4BA03#					±0.5pF	GRM0225C1H5R6DA03#
				±0.25pF	GRM0225C1H5R4CA03#						
			5.5pF	±0.05pF	GRM0225C1H5R5WA03#						
				±0.1pF	GRM0225C1H5R5BA03#						
				±0.25pF	GRM0225C1H5R5CA03#						
			5.6pF	±0.05pF	GRM0225C1H5R6WA03#						
				±0.1pF	GRM0225C1H5R6BA03#						
				±0.25pF	GRM0225C1H5R6CA03#						

Part number # indicates the package specification code.



GRM Series Temperature Compensating Type Part Number List

(→ 0.4×0.2mm)

T max.	Rated Voltage	TC Code	Cap.	Tol.	Part Number	T max.	Rated Voltage	TC Code	Cap.	Tol.	Part Number	
0.22mm	50Vdc	COG	6.9pF	±0.5pF	GRM0225C1H6R9DA03#	0.22mm	50Vdc	COG	8.3pF	±0.1pF	GRM0225C1H8R3BA03#	
				±0.05pF	GRM0225C1H7R0WA03#					±0.25pF	GRM0225C1H8R3CA03#	
				±0.1pF	GRM0225C1H7R0BA03#					±0.5pF	GRM0225C1H8R3DA03#	
			7.0pF	±0.25pF	GRM0225C1H7R0CA03#				8.4pF	±0.05pF	GRM0225C1H8R4WA03#	
				±0.5pF	GRM0225C1H7R0DA03#					±0.1pF	GRM0225C1H8R4BA03#	
				±0.05pF	GRM0225C1H7R1WA03#					±0.25pF	GRM0225C1H8R4CA03#	
				±0.1pF	GRM0225C1H7R1BA03#					±0.5pF	GRM0225C1H8R4DA03#	
			7.1pF	±0.25pF	GRM0225C1H7R1CA03#				8.5pF	±0.05pF	GRM0225C1H8R5WA03#	
				±0.5pF	GRM0225C1H7R1DA03#					±0.1pF	GRM0225C1H8R5BA03#	
				±0.05pF	GRM0225C1H7R2WA03#					±0.25pF	GRM0225C1H8R5CA03#	
			7.2pF	±0.1pF	GRM0225C1H7R2BA03#				8.6pF	±0.5pF	GRM0225C1H8R5DA03#	
				±0.25pF	GRM0225C1H7R2CA03#					±0.05pF	GRM0225C1H8R6WA03#	
				±0.5pF	GRM0225C1H7R2DA03#					±0.1pF	GRM0225C1H8R6BA03#	
			7.3pF	±0.05pF	GRM0225C1H7R3WA03#				8.7pF	±0.25pF	GRM0225C1H8R6CA03#	
				±0.1pF	GRM0225C1H7R3BA03#					±0.5pF	GRM0225C1H8R6DA03#	
				±0.25pF	GRM0225C1H7R3CA03#					8.8pF	±0.05pF	GRM0225C1H8R7WA03#
				±0.5pF	GRM0225C1H7R3DA03#						±0.1pF	GRM0225C1H8R7BA03#
			±0.05pF	GRM0225C1H7R4WA03#	±0.25pF				GRM0225C1H8R7CA03#			
			7.4pF	±0.1pF	GRM0225C1H7R4BA03#				9.0pF	±0.5pF	GRM0225C1H8R7DA03#	
				±0.25pF	GRM0225C1H7R4CA03#					±0.05pF	GRM0225C1H8R8WA03#	
				±0.5pF	GRM0225C1H7R4DA03#					±0.1pF	GRM0225C1H8R8BA03#	
			7.5pF	±0.05pF	GRM0225C1H7R5WA03#				9.1pF	±0.25pF	GRM0225C1H8R8CA03#	
				±0.1pF	GRM0225C1H7R5BA03#					±0.5pF	GRM0225C1H8R8DA03#	
				±0.25pF	GRM0225C1H7R5CA03#					8.9pF	±0.05pF	GRM0225C1H8R9WA03#
				±0.5pF	GRM0225C1H7R5DA03#						±0.1pF	GRM0225C1H8R9BA03#
			±0.05pF	GRM0225C1H7R6WA03#	±0.25pF				GRM0225C1H8R9CA03#			
			7.6pF	±0.1pF	GRM0225C1H7R6BA03#				9.2pF	±0.5pF	GRM0225C1H8R9DA03#	
				±0.25pF	GRM0225C1H7R6CA03#					±0.05pF	GRM0225C1H9R0WA03#	
				±0.5pF	GRM0225C1H7R6DA03#					±0.1pF	GRM0225C1H9R0BA03#	
			7.7pF	±0.25pF	GRM0225C1H7R7CA03#				9.3pF	±0.25pF	GRM0225C1H9R0CA03#	
				±0.5pF	GRM0225C1H7R7DA03#					±0.5pF	GRM0225C1H9R0DA03#	
				±0.05pF	GRM0225C1H7R8WA03#					9.4pF	±0.05pF	GRM0225C1H9R1WA03#
				±0.1pF	GRM0225C1H7R8BA03#						±0.1pF	GRM0225C1H9R1BA03#
			±0.25pF	GRM0225C1H7R8CA03#	±0.25pF				GRM0225C1H9R1CA03#			
			7.8pF	±0.5pF	GRM0225C1H7R8DA03#				9.5pF	±0.5pF	GRM0225C1H9R1DA03#	
				±0.05pF	GRM0225C1H7R9WA03#					9.9pF	±0.05pF	GRM0225C1H9R2WA03#
				±0.1pF	GRM0225C1H7R9BA03#						±0.1pF	GRM0225C1H9R2BA03#
			±0.25pF	GRM0225C1H7R9CA03#	±0.25pF				GRM0225C1H9R2CA03#			
			7.9pF	±0.5pF	GRM0225C1H7R9DA03#				9.3pF	±0.5pF	GRM0225C1H9R2DA03#	
				±0.05pF	GRM0225C1H8R0WA03#					9.3pF	±0.05pF	GRM0225C1H9R3WA03#
				±0.1pF	GRM0225C1H8R0BA03#						±0.1pF	GRM0225C1H9R3BA03#
			±0.25pF	GRM0225C1H8R0CA03#	±0.25pF				GRM0225C1H9R3CA03#			
			8.0pF	±0.5pF	GRM0225C1H8R0DA03#				9.4pF	±0.5pF	GRM0225C1H9R3DA03#	
				±0.05pF	GRM0225C1H8R1WA03#					9.4pF	±0.05pF	GRM0225C1H9R4WA03#
				±0.1pF	GRM0225C1H8R1BA03#						±0.1pF	GRM0225C1H9R4BA03#
			±0.25pF	GRM0225C1H8R1CA03#	±0.25pF				GRM0225C1H9R4CA03#			
			8.1pF	±0.5pF	GRM0225C1H8R1DA03#				9.5pF	±0.5pF	GRM0225C1H9R4DA03#	
				±0.05pF	GRM0225C1H8R2WA03#					9.5pF	±0.05pF	GRM0225C1H9R5WA03#
				±0.1pF	GRM0225C1H8R2BA03#						±0.1pF	GRM0225C1H9R5BA03#
			±0.25pF	GRM0225C1H8R2CA03#	±0.25pF				GRM0225C1H9R5CA03#			
			8.2pF	±0.5pF	GRM0225C1H8R2DA03#				9.6pF	±0.5pF	GRM0225C1H9R5DA03#	
				±0.05pF	GRM0225C1H8R3WA03#					9.6pF	±0.05pF	GRM0225C1H9R6WA03#
				±0.1pF	GRM0225C1H8R3BA03#						±0.1pF	GRM0225C1H9R6BA03#
			±0.25pF	GRM0225C1H8R3CA03#	±0.25pF				GRM0225C1H9R6CA03#			

- GRM
- GR3
- GRJ
- GR4
- GR7
- GJM
- GQM
- GA2
- GA3 GB
- GA3 GD
- GA3 GF
- LLL
- LLA
- LLM
- LLR
- NFM
- KRM
- KR3
- GMA
- GMD
- ⚠Caution /Notice

Part number # indicates the package specification code.

GRM Series Temperature Compensating Type Part Number List

(→ 0.4×0.2mm)

T max.	Rated Voltage	TC Code	Cap.	Tol.	Part Number	T max.	Rated Voltage	TC Code	Cap.	Tol.	Part Number
0.22mm	50Vdc	COG	9.6pF	±0.5pF	GRM0225C1H9R6DA03#	0.22mm	50Vdc	CK	0.50pF	±0.05pF	GRM0224C1HR50WA03#
				±0.05pF	GRM0225C1H9R7WA03#					±0.1pF	GRM0224C1HR50BA03#
				±0.1pF	GRM0225C1H9R7BA03#					±0.05pF	GRM0224C1HR51WA03#
				±0.25pF	GRM0225C1H9R7CA03#					±0.05pF	GRM0224C1HR60WA03#
				±0.5pF	GRM0225C1H9R7DA03#					±0.1pF	GRM0224C1HR60BA03#
			9.8pF	±0.05pF	GRM0225C1H9R8WA03#	0.70pF			±0.05pF	GRM0224C1HR70WA03#	
				±0.1pF	GRM0225C1H9R8BA03#				±0.1pF	GRM0224C1HR70BA03#	
				±0.25pF	GRM0225C1H9R8CA03#				0.80pF	±0.05pF	GRM0224C1HR80WA03#
				±0.5pF	GRM0225C1H9R8DA03#					±0.1pF	GRM0224C1HR80BA03#
			9.9pF	±0.05pF	GRM0225C1H9R9WA03#	0.90pF			±0.05pF	GRM0224C1HR90WA03#	
				±0.1pF	GRM0225C1H9R9BA03#				±0.1pF	GRM0224C1HR90BA03#	
				±0.25pF	GRM0225C1H9R9CA03#	1.0pF			±0.05pF	GRM0224C1H1R0WA03#	
				±0.5pF	GRM0225C1H9R9DA03#				±0.1pF	GRM0224C1H1R0BA03#	
			10pF	±2%	GRM0225C1H100GA03#	1.1pF			±0.05pF	GRM0224C1H1R1WA03#	
				±5%	GRM0225C1H100JA03#				±0.1pF	GRM0224C1H1R1BA03#	
			11pF	±2%	GRM0225C1H110GA03#	1.2pF			±0.25pF	GRM0224C1H1R1CA03#	
				±5%	GRM0225C1H110JA03#				±0.05pF	GRM0224C1H1R2WA03#	
			12pF	±2%	GRM0225C1H120GA03#				±0.1pF	GRM0224C1H1R2BA03#	
				±5%	GRM0225C1H120JA03#	±0.25pF			GRM0224C1H1R2CA03#		
			13pF	±2%	GRM0225C1H130GA03#	1.3pF			±0.05pF	GRM0224C1H1R3WA03#	
				±5%	GRM0225C1H130JA03#				±0.1pF	GRM0224C1H1R3BA03#	
			15pF	±2%	GRM0225C1H150GA03#				±0.25pF	GRM0224C1H1R3CA03#	
				±5%	GRM0225C1H150JA03#	1.4pF			±0.05pF	GRM0224C1H1R4WA03#	
			16pF	±2%	GRM0225C1H160GA03#				±0.1pF	GRM0224C1H1R4BA03#	
				±5%	GRM0225C1H160JA03#				±0.25pF	GRM0224C1H1R4CA03#	
			17pF	±5%	GRM0225C1H170JA02#	1.5pF			±0.05pF	GRM0224C1H1R5WA03#	
			18pF	±5%	GRM0225C1H180JA02#				±0.1pF	GRM0224C1H1R5BA03#	
			19pF	±5%	GRM0225C1H190JA02#				±0.25pF	GRM0224C1H1R5CA03#	
			20pF	±5%	GRM0225C1H200JA02#	1.6pF			±0.05pF	GRM0224C1H1R6WA03#	
			21pF	±5%	GRM0225C1H210JA02#				±0.1pF	GRM0224C1H1R6BA03#	
			22pF	±5%	GRM0225C1H220JA02#				±0.25pF	GRM0224C1H1R6CA03#	
			23pF	±5%	GRM0225C1H230JA02#	1.7pF			±0.05pF	GRM0224C1H1R7WA03#	
			24pF	±5%	GRM0225C1H240JA02#				±0.1pF	GRM0224C1H1R7BA03#	
			27pF	±5%	GRM0225C1H270JA02#				±0.25pF	GRM0224C1H1R7CA03#	
			30pF	±5%	GRM0225C1H300JA02#	1.8pF			±0.05pF	GRM0224C1H1R8WA03#	
			33pF	±5%	GRM0225C1H330JA02#				±0.1pF	GRM0224C1H1R8BA03#	
			36pF	±5%	GRM0225C1H360JA02#				±0.25pF	GRM0224C1H1R8CA03#	
			39pF	±5%	GRM0225C1H390JA02#	1.9pF			±0.05pF	GRM0224C1H1R9WA03#	
			43pF	±5%	GRM0225C1H430JA02#				±0.1pF	GRM0224C1H1R9BA03#	
			47pF	±5%	GRM0225C1H470JA02#				±0.25pF	GRM0224C1H1R9CA03#	
			51pF	±5%	GRM0225C1H510JA02#	2.0pF			±0.05pF	GRM0224C1H2R0WA03#	
			56pF	±5%	GRM0225C1H560JA02#				±0.1pF	GRM0224C1H2R0BA03#	
			62pF	±5%	GRM0225C1H620JA02#				±0.25pF	GRM0224C1H2R0CA03#	
			68pF	±5%	GRM0225C1H680JA02#	2.1pF			±0.05pF	GRM0223C1H2R1WA03#	
			75pF	±5%	GRM0225C1H750JA02#				±0.1pF	GRM0223C1H2R1BA03#	
			82pF	±5%	GRM0225C1H820JA02#				±0.25pF	GRM0223C1H2R1CA03#	
			91pF	±5%	GRM0225C1H910JA02#	2.2pF			±0.05pF	GRM0223C1H2R2WA03#	
			100pF	±5%	GRM0225C1H101JA02#				±0.1pF	GRM0223C1H2R2BA03#	
			0.20pF	±0.05pF	GRM0224C1HR20WA03#				±0.25pF	GRM0223C1H2R2CA03#	
				±0.1pF	GRM0224C1HR20BA03#	2.3pF			±0.05pF	GRM0223C1H2R3WA03#	
0.30pF	±0.05pF	GRM0224C1HR30WA03#	±0.1pF	GRM0223C1H2R3BA03#							
	±0.1pF	GRM0224C1HR30BA03#	±0.25pF	GRM0223C1H2R3CA03#							
0.40pF	±0.05pF	GRM0224C1HR40WA03#	2.4pF	±0.05pF	GRM0223C1H2R4WA03#						
	±0.1pF	GRM0224C1HR40BA03#									

Part number # indicates the package specification code.

GRM Series Temperature Compensating Type Part Number List

(→ 0.4×0.2mm)

T max.	Rated Voltage	TC Code	Cap.	Tol.	Part Number	T max.	Rated Voltage	TC Code	Cap.	Tol.	Part Number	
0.22mm	50Vdc	CJ	2.4pF	±0.1pF	GRM0223C1H2R4BA03#	0.22mm	50Vdc	CH	4.2pF	±0.1pF	GRM0222C1H4R2BA03#	
				±0.25pF	GRM0223C1H2R4CA03#					±0.25pF	GRM0222C1H4R2CA03#	
			2.5pF	±0.05pF	GRM0223C1H2R5WA03#				4.3pF	±0.05pF	GRM0222C1H4R3WA03#	
				±0.1pF	GRM0223C1H2R5BA03#					±0.1pF	GRM0222C1H4R3BA03#	
				±0.25pF	GRM0223C1H2R5CA03#					±0.25pF	GRM0222C1H4R3CA03#	
			2.6pF	±0.05pF	GRM0223C1H2R6WA03#				4.4pF	±0.05pF	GRM0222C1H4R4WA03#	
				±0.1pF	GRM0223C1H2R6BA03#					±0.1pF	GRM0222C1H4R4BA03#	
				±0.25pF	GRM0223C1H2R6CA03#					±0.25pF	GRM0222C1H4R4CA03#	
			2.7pF	±0.05pF	GRM0223C1H2R7WA03#				4.5pF	±0.05pF	GRM0222C1H4R5WA03#	
				±0.1pF	GRM0223C1H2R7BA03#					±0.1pF	GRM0222C1H4R5BA03#	
				±0.25pF	GRM0223C1H2R7CA03#					±0.25pF	GRM0222C1H4R5CA03#	
			2.8pF	±0.05pF	GRM0223C1H2R8WA03#				4.6pF	±0.05pF	GRM0222C1H4R6WA03#	
				±0.1pF	GRM0223C1H2R8BA03#					±0.1pF	GRM0222C1H4R6BA03#	
				±0.25pF	GRM0223C1H2R8CA03#					±0.25pF	GRM0222C1H4R6CA03#	
			2.9pF	±0.05pF	GRM0223C1H2R9WA03#				4.7pF	±0.05pF	GRM0222C1H4R7WA03#	
				±0.1pF	GRM0223C1H2R9BA03#					±0.1pF	GRM0222C1H4R7BA03#	
				±0.25pF	GRM0223C1H2R9CA03#					±0.25pF	GRM0222C1H4R7CA03#	
			3.0pF	±0.05pF	GRM0223C1H3R0WA03#				4.8pF	±0.05pF	GRM0222C1H4R8WA03#	
				±0.1pF	GRM0223C1H3R0BA03#					±0.1pF	GRM0222C1H4R8BA03#	
				±0.25pF	GRM0223C1H3R0CA03#					±0.25pF	GRM0222C1H4R8CA03#	
			3.1pF	±0.05pF	GRM0223C1H3R1WA03#				4.9pF	±0.05pF	GRM0222C1H4R9WA03#	
				±0.1pF	GRM0223C1H3R1BA03#					±0.1pF	GRM0222C1H4R9BA03#	
				±0.25pF	GRM0223C1H3R1CA03#					±0.25pF	GRM0222C1H4R9CA03#	
			3.2pF	±0.05pF	GRM0223C1H3R2WA03#				5.0pF	±0.05pF	GRM0222C1H5R0WA03#	
				±0.1pF	GRM0223C1H3R2BA03#					±0.1pF	GRM0222C1H5R0BA03#	
				±0.25pF	GRM0223C1H3R2CA03#					±0.25pF	GRM0222C1H5R0CA03#	
			3.3pF	±0.05pF	GRM0223C1H3R3WA03#				5.1pF	±0.05pF	GRM0222C1H5R1WA03#	
				±0.1pF	GRM0223C1H3R3BA03#					±0.1pF	GRM0222C1H5R1BA03#	
				±0.25pF	GRM0223C1H3R3CA03#					±0.25pF	GRM0222C1H5R1CA03#	
			3.4pF	±0.05pF	GRM0223C1H3R4WA03#				5.2pF	±0.05pF	GRM0222C1H5R2WA03#	
				±0.1pF	GRM0223C1H3R4BA03#					±0.1pF	GRM0222C1H5R2BA03#	
				±0.25pF	GRM0223C1H3R4CA03#					±0.25pF	GRM0222C1H5R2CA03#	
			3.5pF	±0.05pF	GRM0223C1H3R5WA03#				5.3pF	±0.05pF	GRM0222C1H5R3WA03#	
				±0.1pF	GRM0223C1H3R5BA03#					±0.1pF	GRM0222C1H5R3BA03#	
				±0.25pF	GRM0223C1H3R5CA03#					±0.25pF	GRM0222C1H5R3CA03#	
			3.6pF	±0.05pF	GRM0223C1H3R6WA03#				5.4pF	±0.05pF	GRM0222C1H5R4WA03#	
				±0.1pF	GRM0223C1H3R6BA03#					±0.1pF	GRM0222C1H5R4BA03#	
				±0.25pF	GRM0223C1H3R6CA03#					±0.25pF	GRM0222C1H5R4CA03#	
			3.7pF	±0.05pF	GRM0223C1H3R7WA03#				5.5pF	±0.05pF	GRM0222C1H5R5WA03#	
				±0.1pF	GRM0223C1H3R7BA03#					±0.1pF	GRM0222C1H5R5BA03#	
				±0.25pF	GRM0223C1H3R7CA03#					±0.25pF	GRM0222C1H5R5CA03#	
			3.8pF	±0.05pF	GRM0223C1H3R8WA03#				5.6pF	±0.05pF	GRM0222C1H5R6WA03#	
				±0.1pF	GRM0223C1H3R8BA03#					±0.1pF	GRM0222C1H5R6BA03#	
				±0.25pF	GRM0223C1H3R8CA03#					±0.25pF	GRM0222C1H5R6CA03#	
			3.9pF	±0.05pF	GRM0223C1H3R9WA03#				5.7pF	±0.05pF	GRM0222C1H5R7WA03#	
				±0.1pF	GRM0223C1H3R9BA03#					±0.1pF	GRM0222C1H5R7BA03#	
				±0.25pF	GRM0223C1H3R9CA03#					±0.25pF	GRM0222C1H5R7CA03#	
			CH	4.0pF	±0.05pF				GRM0222C1H4R0WA03#	±0.05pF	GRM0222C1H5R7DA03#	
					±0.1pF				GRM0222C1H4R0BA03#		±0.1pF	GRM0222C1H5R7BA03#
					±0.25pF				GRM0222C1H4R0CA03#		±0.25pF	GRM0222C1H5R7CA03#
		±0.05pF			GRM0222C1H4R1WA03#	±0.05pF	GRM0222C1H5R7DA03#					
		4.1pF	±0.05pF	GRM0222C1H4R1WA03#	±0.05pF	GRM0222C1H5R7BA03#						
			±0.1pF	GRM0222C1H4R1BA03#		±0.1pF	GRM0222C1H5R7BA03#					
			±0.25pF	GRM0222C1H4R1CA03#		±0.25pF	GRM0222C1H5R7CA03#					
		4.2pF	±0.05pF	GRM0222C1H4R2WA03#	±0.05pF	GRM0222C1H5R7DA03#						
			±0.05pF	GRM0222C1H4R2WA03#		±0.05pF	GRM0222C1H5R7DA03#					

GRM
 GR3
 GRJ
 GR4
 GR7
 GJM
 GQM
 GA2
 GA3 GB
 GA3 GD
 GA3 GF
 LLL
 LLA
 LLM
 LLR
 NFM
 KRM
 KR3
 GMA
 GMD
 ⚠Caution /Notice

Part number # indicates the package specification code.

GRM Series Temperature Compensating Type Part Number List

(→ 0.4×0.2mm)

T max.	Rated Voltage	TC Code	Cap.	Tol.	Part Number
0.22mm	50Vdc	CH	5.8pF	±0.05pF	GRM0222C1H5R8WA03#
				±0.1pF	GRM0222C1H5R8BA03#
				±0.25pF	GRM0222C1H5R8CA03#
				±0.5pF	GRM0222C1H5R8DA03#
			5.9pF	±0.05pF	GRM0222C1H5R9WA03#
				±0.1pF	GRM0222C1H5R9BA03#
				±0.25pF	GRM0222C1H5R9CA03#
				±0.5pF	GRM0222C1H5R9DA03#
			6.0pF	±0.05pF	GRM0222C1H6R0WA03#
				±0.1pF	GRM0222C1H6R0BA03#
				±0.25pF	GRM0222C1H6R0CA03#
				±0.5pF	GRM0222C1H6R0DA03#
			6.1pF	±0.05pF	GRM0222C1H6R1WA03#
				±0.1pF	GRM0222C1H6R1BA03#
				±0.25pF	GRM0222C1H6R1CA03#
				±0.5pF	GRM0222C1H6R1DA03#
			6.2pF	±0.05pF	GRM0222C1H6R2WA03#
				±0.1pF	GRM0222C1H6R2BA03#
				±0.25pF	GRM0222C1H6R2CA03#
				±0.5pF	GRM0222C1H6R2DA03#
			6.3pF	±0.05pF	GRM0222C1H6R3WA03#
				±0.1pF	GRM0222C1H6R3BA03#
				±0.25pF	GRM0222C1H6R3CA03#
				±0.5pF	GRM0222C1H6R3DA03#
			6.4pF	±0.05pF	GRM0222C1H6R4WA03#
				±0.1pF	GRM0222C1H6R4BA03#
				±0.25pF	GRM0222C1H6R4CA03#
				±0.5pF	GRM0222C1H6R4DA03#
			6.5pF	±0.05pF	GRM0222C1H6R5WA03#
				±0.1pF	GRM0222C1H6R5BA03#
				±0.25pF	GRM0222C1H6R5CA03#
				±0.5pF	GRM0222C1H6R5DA03#
			6.6pF	±0.05pF	GRM0222C1H6R6WA03#
				±0.1pF	GRM0222C1H6R6BA03#
				±0.25pF	GRM0222C1H6R6CA03#
				±0.5pF	GRM0222C1H6R6DA03#
			6.7pF	±0.05pF	GRM0222C1H6R7WA03#
				±0.1pF	GRM0222C1H6R7BA03#
				±0.25pF	GRM0222C1H6R7CA03#
				±0.5pF	GRM0222C1H6R7DA03#
			6.8pF	±0.05pF	GRM0222C1H6R8WA03#
				±0.1pF	GRM0222C1H6R8BA03#
				±0.25pF	GRM0222C1H6R8CA03#
				±0.5pF	GRM0222C1H6R8DA03#
			6.9pF	±0.05pF	GRM0222C1H6R9WA03#
				±0.1pF	GRM0222C1H6R9BA03#
				±0.25pF	GRM0222C1H6R9CA03#
				±0.5pF	GRM0222C1H6R9DA03#
			7.0pF	±0.05pF	GRM0222C1H7R0WA03#
				±0.1pF	GRM0222C1H7R0BA03#
				±0.25pF	GRM0222C1H7R0CA03#
				±0.5pF	GRM0222C1H7R0DA03#
			7.1pF	±0.05pF	GRM0222C1H7R1WA03#
				±0.1pF	GRM0222C1H7R1BA03#

T max.	Rated Voltage	TC Code	Cap.	Tol.	Part Number
0.22mm	50Vdc	CH	7.1pF	±0.25pF	GRM0222C1H7R1CA03#
				±0.5pF	GRM0222C1H7R1DA03#
			7.2pF	±0.05pF	GRM0222C1H7R2WA03#
				±0.1pF	GRM0222C1H7R2BA03#
				±0.25pF	GRM0222C1H7R2CA03#
				±0.5pF	GRM0222C1H7R2DA03#
			7.3pF	±0.05pF	GRM0222C1H7R3WA03#
				±0.1pF	GRM0222C1H7R3BA03#
				±0.25pF	GRM0222C1H7R3CA03#
				±0.5pF	GRM0222C1H7R3DA03#
			7.4pF	±0.05pF	GRM0222C1H7R4WA03#
				±0.1pF	GRM0222C1H7R4BA03#
				±0.25pF	GRM0222C1H7R4CA03#
				±0.5pF	GRM0222C1H7R4DA03#
			7.5pF	±0.05pF	GRM0222C1H7R5WA03#
				±0.1pF	GRM0222C1H7R5BA03#
				±0.25pF	GRM0222C1H7R5CA03#
				±0.5pF	GRM0222C1H7R5DA03#
			7.6pF	±0.05pF	GRM0222C1H7R6WA03#
				±0.1pF	GRM0222C1H7R6BA03#
				±0.25pF	GRM0222C1H7R6CA03#
				±0.5pF	GRM0222C1H7R6DA03#
			7.7pF	±0.05pF	GRM0222C1H7R7WA03#
				±0.1pF	GRM0222C1H7R7BA03#
				±0.25pF	GRM0222C1H7R7CA03#
				±0.5pF	GRM0222C1H7R7DA03#
			7.8pF	±0.05pF	GRM0222C1H7R8WA03#
				±0.1pF	GRM0222C1H7R8BA03#
				±0.25pF	GRM0222C1H7R8CA03#
				±0.5pF	GRM0222C1H7R8DA03#
			7.9pF	±0.05pF	GRM0222C1H7R9WA03#
				±0.1pF	GRM0222C1H7R9BA03#
				±0.25pF	GRM0222C1H7R9CA03#
				±0.5pF	GRM0222C1H7R9DA03#
			8.0pF	±0.05pF	GRM0222C1H8R0WA03#
				±0.1pF	GRM0222C1H8R0BA03#
				±0.25pF	GRM0222C1H8R0CA03#
				±0.5pF	GRM0222C1H8R0DA03#
			8.1pF	±0.05pF	GRM0222C1H8R1WA03#
				±0.1pF	GRM0222C1H8R1BA03#
				±0.25pF	GRM0222C1H8R1CA03#
				±0.5pF	GRM0222C1H8R1DA03#
			8.2pF	±0.05pF	GRM0222C1H8R2WA03#
				±0.1pF	GRM0222C1H8R2BA03#
				±0.25pF	GRM0222C1H8R2CA03#
				±0.5pF	GRM0222C1H8R2DA03#
			8.3pF	±0.05pF	GRM0222C1H8R3WA03#
				±0.1pF	GRM0222C1H8R3BA03#
				±0.25pF	GRM0222C1H8R3CA03#
				±0.5pF	GRM0222C1H8R3DA03#
			8.4pF	±0.05pF	GRM0222C1H8R4WA03#
				±0.1pF	GRM0222C1H8R4BA03#
				±0.25pF	GRM0222C1H8R4CA03#
				±0.5pF	GRM0222C1H8R4DA03#

Part number # indicates the package specification code.

GRM
 GR3
 GRJ
 GR4
 GR7
 GJM
 GQM
 GA2
 GA3 GB
 GA3 GD
 GA3 GF
 LLL
 LLA
 LLM
 LLR
 NFM
 KRM
 KR3
 GMA
 GMD
 ⚠Caution /Notice

GRM Series Temperature Compensating Type Part Number List

(→ 0.4×0.2mm)

T max.	Rated Voltage	TC Code	Cap.	Tol.	Part Number	T max.	Rated Voltage	TC Code	Cap.	Tol.	Part Number		
0.22mm	50Vdc	CH	8.5pF	±0.05pF	GRM0222C1H8R5WA03#	0.22mm	50Vdc	CH	9.8pF	±0.25pF	GRM0222C1H9R8CA03#		
				±0.1pF	GRM0222C1H8R5BA03#					±0.5pF	GRM0222C1H9R8DA03#		
				±0.25pF	GRM0222C1H8R5CA03#					9.9pF	±0.05pF	GRM0222C1H9R9WA03#	
				±0.5pF	GRM0222C1H8R5DA03#						±0.1pF	GRM0222C1H9R9BA03#	
			8.6pF	±0.05pF	GRM0222C1H8R6WA03#				±0.25pF		GRM0222C1H9R9CA03#		
				±0.1pF	GRM0222C1H8R6BA03#				±0.5pF		GRM0222C1H9R9DA03#		
				±0.25pF	GRM0222C1H8R6CA03#				10pF	±2%	GRM0222C1H100GA03#		
				±0.5pF	GRM0222C1H8R6DA03#					±5%	GRM0222C1H100JA03#		
			8.7pF	±0.05pF	GRM0222C1H8R7WA03#				11pF	±2%	GRM0222C1H110GA03#		
				±0.1pF	GRM0222C1H8R7BA03#					±5%	GRM0222C1H110JA03#		
				±0.25pF	GRM0222C1H8R7CA03#				12pF	±2%	GRM0222C1H120GA03#		
				±0.5pF	GRM0222C1H8R7DA03#					±5%	GRM0222C1H120JA03#		
			8.8pF	±0.05pF	GRM0222C1H8R8WA03#				13pF	±2%	GRM0222C1H130GA03#		
				±0.1pF	GRM0222C1H8R8BA03#					±5%	GRM0222C1H130JA03#		
				±0.25pF	GRM0222C1H8R8CA03#				15pF	±2%	GRM0222C1H150GA03#		
				±0.5pF	GRM0222C1H8R8DA03#					±5%	GRM0222C1H150JA03#		
			8.9pF	±0.05pF	GRM0222C1H8R9WA03#				16pF	±2%	GRM0222C1H160GA03#		
				±0.1pF	GRM0222C1H8R9BA03#					±5%	GRM0222C1H160JA03#		
				±0.25pF	GRM0222C1H8R9CA03#				17pF	±5%	GRM0222C1H170JA02#		
				±0.5pF	GRM0222C1H8R9DA03#					18pF	±5%	GRM0222C1H180JA02#	
			9.0pF	±0.05pF	GRM0222C1H9R0WA03#				19pF		±5%	GRM0222C1H190JA02#	
				±0.1pF	GRM0222C1H9R0BA03#					20pF	±5%	GRM0222C1H200JA02#	
				±0.25pF	GRM0222C1H9R0CA03#				21pF		±5%	GRM0222C1H210JA02#	
				±0.5pF	GRM0222C1H9R0DA03#					22pF	±5%	GRM0222C1H220JA02#	
			9.1pF	±0.05pF	GRM0222C1H9R1WA03#				23pF		±5%	GRM0222C1H230JA02#	
				±0.1pF	GRM0222C1H9R1BA03#					24pF	±5%	GRM0222C1H240JA02#	
				±0.25pF	GRM0222C1H9R1CA03#				27pF		±5%	GRM0222C1H270JA02#	
				±0.5pF	GRM0222C1H9R1DA03#					30pF	±5%	GRM0222C1H300JA02#	
			9.2pF	±0.05pF	GRM0222C1H9R2WA03#				33pF		±5%	GRM0222C1H330JA02#	
				±0.1pF	GRM0222C1H9R2BA03#					36pF	±5%	GRM0222C1H360JA02#	
				±0.25pF	GRM0222C1H9R2CA03#				39pF		±5%	GRM0222C1H390JA02#	
				±0.5pF	GRM0222C1H9R2DA03#					43pF	±5%	GRM0222C1H430JA02#	
			9.3pF	±0.05pF	GRM0222C1H9R3WA03#				47pF		±5%	GRM0222C1H470JA02#	
				±0.1pF	GRM0222C1H9R3BA03#					51pF	±5%	GRM0222C1H510JA02#	
				±0.25pF	GRM0222C1H9R3CA03#				56pF		±5%	GRM0222C1H560JA02#	
				±0.5pF	GRM0222C1H9R3DA03#					62pF	±5%	GRM0222C1H620JA02#	
			9.4pF	±0.05pF	GRM0222C1H9R4WA03#				68pF		±5%	GRM0222C1H680JA02#	
				±0.1pF	GRM0222C1H9R4BA03#					75pF	±5%	GRM0222C1H750JA02#	
				±0.25pF	GRM0222C1H9R4CA03#				82pF		±5%	GRM0222C1H820JA02#	
				±0.5pF	GRM0222C1H9R4DA03#					91pF	±5%	GRM0222C1H910JA02#	
			9.5pF	±0.05pF	GRM0222C1H9R5WA03#				100pF		±5%	GRM0222C1H101JA02#	
				±0.1pF	GRM0222C1H9R5BA03#					25Vdc	COG	120pF	±5%
				±0.25pF	GRM0222C1H9R5CA03#				150pF			±5%	GRM0225C1E151JA02#
				±0.5pF	GRM0222C1H9R5DA03#				180pF			±5%	GRM0225C1E181JA02#
			9.6pF	±0.05pF	GRM0222C1H9R6WA03#				220pF			±5%	GRM0225C1E221JA02#
				±0.1pF	GRM0222C1H9R6BA03#				CH	120pF	±5%	GRM0222C1E121JA02#	
				±0.25pF	GRM0222C1H9R6CA03#					150pF	±5%	GRM0222C1E151JA02#	
				±0.5pF	GRM0222C1H9R6DA03#					180pF	±5%	GRM0222C1E181JA02#	
			9.7pF	±0.05pF	GRM0222C1H9R7WA03#					220pF	±5%	GRM0222C1E221JA02#	
				±0.1pF	GRM0222C1H9R7BA03#				16Vdc	COG	120pF	±5%	GRM0225C1C121JA02#
				±0.25pF	GRM0222C1H9R7CA03#						150pF	±5%	GRM0225C1C151JA02#
				±0.5pF	GRM0222C1H9R7DA03#						180pF	±5%	GRM0225C1C181JA02#
			9.8pF	±0.05pF	GRM0222C1H9R8WA03#						220pF	±5%	GRM0225C1C221JA02#
				±0.1pF	GRM0222C1H9R8BA03#				CH	120pF	±5%	GRM0222C1C121JA02#	

GRM
 GR3
 GRJ
 GR4
 GR7
 GJM
 GQM
 GA2
 GA3 GB
 GA3 GD
 GA3 GF
 LLL
 LLA
 LLM
 LLR
 NFM
 KRM
 KR3
 GMA
 GMD
 ⚠Caution /Notice

Part number # indicates the package specification code.

GRM Series Temperature Compensating Type Part Number List

(→ 0.4×0.2mm)

T max.	Rated Voltage	TC Code	Cap.	Tol.	Part Number
0.22mm	16Vdc	CH	150pF	±5%	GRM0222C1C151JA02#
			180pF	±5%	GRM0222C1C181JA02#
			220pF	±5%	GRM0222C1C221JA02#

T max.	Rated Voltage	TC Code	Cap.	Tol.	Part Number
0.33mm	100Vdc	COG	1.9pF	±0.25pF	GRM0335C2A1R9CA01#
			2.0pF	±0.05pF	GRM0335C2A2R0WA01#
				±0.1pF	GRM0335C2A2R0BA01#
				±0.25pF	GRM0335C2A2R0CA01#
			2.1pF	±0.05pF	GRM0335C2A2R1WA01#
				±0.1pF	GRM0335C2A2R1BA01#
				±0.25pF	GRM0335C2A2R1CA01#
			2.2pF	±0.05pF	GRM0335C2A2R2WA01#
				±0.1pF	GRM0335C2A2R2BA01#
				±0.25pF	GRM0335C2A2R2CA01#
			2.3pF	±0.05pF	GRM0335C2A2R3WA01#
				±0.1pF	GRM0335C2A2R3BA01#
				±0.25pF	GRM0335C2A2R3CA01#
			2.4pF	±0.05pF	GRM0335C2A2R4WA01#
				±0.1pF	GRM0335C2A2R4BA01#
				±0.25pF	GRM0335C2A2R4CA01#
			2.5pF	±0.05pF	GRM0335C2A2R5WA01#
				±0.1pF	GRM0335C2A2R5BA01#
				±0.25pF	GRM0335C2A2R5CA01#
			2.6pF	±0.05pF	GRM0335C2A2R6WA01#
				±0.1pF	GRM0335C2A2R6BA01#
				±0.25pF	GRM0335C2A2R6CA01#
			2.7pF	±0.05pF	GRM0335C2A2R7WA01#
				±0.1pF	GRM0335C2A2R7BA01#
				±0.25pF	GRM0335C2A2R7CA01#
			2.8pF	±0.05pF	GRM0335C2A2R8WA01#
				±0.1pF	GRM0335C2A2R8BA01#
				±0.25pF	GRM0335C2A2R8CA01#
			2.9pF	±0.05pF	GRM0335C2A2R9WA01#
				±0.1pF	GRM0335C2A2R9BA01#
				±0.25pF	GRM0335C2A2R9CA01#
			3.0pF	±0.05pF	GRM0335C2A3R0WA01#
				±0.1pF	GRM0335C2A3R0BA01#
				±0.25pF	GRM0335C2A3R0CA01#
			3.1pF	±0.05pF	GRM0335C2A3R1WA01#
				±0.1pF	GRM0335C2A3R1BA01#
				±0.25pF	GRM0335C2A3R1CA01#
			3.2pF	±0.05pF	GRM0335C2A3R2WA01#
				±0.1pF	GRM0335C2A3R2BA01#
				±0.25pF	GRM0335C2A3R2CA01#
			3.3pF	±0.05pF	GRM0335C2A3R3WA01#
				±0.1pF	GRM0335C2A3R3BA01#
±0.25pF	GRM0335C2A3R3CA01#				
3.4pF	±0.05pF	GRM0335C2A3R4WA01#			
	±0.1pF	GRM0335C2A3R4BA01#			
	±0.25pF	GRM0335C2A3R4CA01#			
3.5pF	±0.05pF	GRM0335C2A3R5WA01#			
	±0.1pF	GRM0335C2A3R5BA01#			
	±0.25pF	GRM0335C2A3R5CA01#			
3.6pF	±0.05pF	GRM0335C2A3R6WA01#			
	±0.1pF	GRM0335C2A3R6BA01#			
	±0.25pF	GRM0335C2A3R6CA01#			
3.7pF	±0.05pF	GRM0335C2A3R7WA01#			
	±0.1pF	GRM0335C2A3R7BA01#			

0.6×0.3mm

T max.	Rated Voltage	TC Code	Cap.	Tol.	Part Number
0.33mm	100Vdc	COG	0.10pF	±0.05pF	GRM0335C2AR10WA01#
			0.20pF	±0.05pF	GRM0335C2AR20WA01#
				±0.1pF	GRM0335C2AR20BA01#
			0.30pF	±0.05pF	GRM0335C2AR30WA01#
				±0.1pF	GRM0335C2AR30BA01#
			0.40pF	±0.05pF	GRM0335C2AR40WA01#
				±0.1pF	GRM0335C2AR40BA01#
			0.50pF	±0.05pF	GRM0335C2AR50WA01#
				±0.1pF	GRM0335C2AR50BA01#
			0.60pF	±0.05pF	GRM0335C2AR60WA01#
				±0.1pF	GRM0335C2AR60BA01#
			0.70pF	±0.05pF	GRM0335C2AR70WA01#
				±0.1pF	GRM0335C2AR70BA01#
			0.80pF	±0.05pF	GRM0335C2AR80WA01#
				±0.1pF	GRM0335C2AR80BA01#
			0.90pF	±0.05pF	GRM0335C2AR90WA01#
				±0.1pF	GRM0335C2AR90BA01#
			1.0pF	±0.05pF	GRM0335C2A1R0WA01#
				±0.1pF	GRM0335C2A1R0BA01#
				±0.25pF	GRM0335C2A1R0CA01#
			1.1pF	±0.05pF	GRM0335C2A1R1WA01#
				±0.1pF	GRM0335C2A1R1BA01#
				±0.25pF	GRM0335C2A1R1CA01#
			1.2pF	±0.05pF	GRM0335C2A1R2WA01#
				±0.1pF	GRM0335C2A1R2BA01#
				±0.25pF	GRM0335C2A1R2CA01#
			1.3pF	±0.05pF	GRM0335C2A1R3WA01#
				±0.1pF	GRM0335C2A1R3BA01#
				±0.25pF	GRM0335C2A1R3CA01#
			1.4pF	±0.05pF	GRM0335C2A1R4WA01#
				±0.1pF	GRM0335C2A1R4BA01#
				±0.25pF	GRM0335C2A1R4CA01#
			1.5pF	±0.05pF	GRM0335C2A1R5WA01#
				±0.1pF	GRM0335C2A1R5BA01#
				±0.25pF	GRM0335C2A1R5CA01#
			1.6pF	±0.05pF	GRM0335C2A1R6WA01#
				±0.1pF	GRM0335C2A1R6BA01#
				±0.25pF	GRM0335C2A1R6CA01#
			1.7pF	±0.05pF	GRM0335C2A1R7WA01#
				±0.1pF	GRM0335C2A1R7BA01#
				±0.25pF	GRM0335C2A1R7CA01#
			1.8pF	±0.05pF	GRM0335C2A1R8WA01#
±0.1pF	GRM0335C2A1R8BA01#				
±0.25pF	GRM0335C2A1R8CA01#				
1.9pF	±0.05pF	GRM0335C2A1R9WA01#			
	±0.1pF	GRM0335C2A1R9BA01#			

Part number # indicates the package specification code.

GRM
 GR3
 GRJ
 GR4
 GR7
 GJM
 GQM
 GA2
 GA3 GB
 GA3 GD
 GA3 GF
 LLL
 LLA
 LLM
 LLR
 NFM
 KRM
 KR3
 GMA
 GMD
 ⚠Caution /Notice

GRM Series Temperature Compensating Type Part Number List

(→ 0.6×0.3mm)

T max.	Rated Voltage	TC Code	Cap.	Tol.	Part Number	
0.33mm	100Vdc	COG	3.7pF	±0.25pF	GRM0335C2A3R7CA01#	
				±0.05pF	GRM0335C2A3R8WA01#	
					±0.1pF	GRM0335C2A3R8BA01#
			±0.25pF	GRM0335C2A3R8CA01#		
				3.9pF	±0.05pF	GRM0335C2A3R9WA01#
					±0.1pF	GRM0335C2A3R9BA01#
			±0.25pF		GRM0335C2A3R9CA01#	
			4.0pF	±0.05pF	GRM0335C2A4R0WA01#	
				±0.1pF	GRM0335C2A4R0BA01#	
				±0.25pF	GRM0335C2A4R0CA01#	
			4.1pF	±0.05pF	GRM0335C2A4R1WA01#	
				±0.1pF	GRM0335C2A4R1BA01#	
				±0.25pF	GRM0335C2A4R1CA01#	
			4.2pF	±0.05pF	GRM0335C2A4R2WA01#	
				±0.1pF	GRM0335C2A4R2BA01#	
				±0.25pF	GRM0335C2A4R2CA01#	
			4.3pF	±0.05pF	GRM0335C2A4R3WA01#	
				±0.1pF	GRM0335C2A4R3BA01#	
				±0.25pF	GRM0335C2A4R3CA01#	
			4.4pF	±0.05pF	GRM0335C2A4R4WA01#	
				±0.1pF	GRM0335C2A4R4BA01#	
				±0.25pF	GRM0335C2A4R4CA01#	
			4.5pF	±0.05pF	GRM0335C2A4R5WA01#	
				±0.1pF	GRM0335C2A4R5BA01#	
				±0.25pF	GRM0335C2A4R5CA01#	
			4.6pF	±0.05pF	GRM0335C2A4R6WA01#	
				±0.1pF	GRM0335C2A4R6BA01#	
				±0.25pF	GRM0335C2A4R6CA01#	
			4.7pF	±0.05pF	GRM0335C2A4R7WA01#	
				±0.1pF	GRM0335C2A4R7BA01#	
				±0.25pF	GRM0335C2A4R7CA01#	
			4.8pF	±0.05pF	GRM0335C2A4R8WA01#	
				±0.1pF	GRM0335C2A4R8BA01#	
				±0.25pF	GRM0335C2A4R8CA01#	
			4.9pF	±0.05pF	GRM0335C2A4R9WA01#	
				±0.1pF	GRM0335C2A4R9BA01#	
				±0.25pF	GRM0335C2A4R9CA01#	
			5.0pF	±0.05pF	GRM0335C2A5R0WA01#	
				±0.1pF	GRM0335C2A5R0BA01#	
				±0.25pF	GRM0335C2A5R0CA01#	
			5.1pF	±0.05pF	GRM0335C2A5R1WA01#	
				±0.1pF	GRM0335C2A5R1BA01#	
				±0.25pF	GRM0335C2A5R1CA01#	
				±0.5pF	GRM0335C2A5R1DA01#	
			5.2pF	±0.05pF	GRM0335C2A5R2WA01#	
				±0.1pF	GRM0335C2A5R2BA01#	
				±0.25pF	GRM0335C2A5R2CA01#	
				±0.5pF	GRM0335C2A5R2DA01#	
			5.3pF	±0.05pF	GRM0335C2A5R3WA01#	
				±0.1pF	GRM0335C2A5R3BA01#	
				±0.25pF	GRM0335C2A5R3CA01#	
				±0.5pF	GRM0335C2A5R3DA01#	
			5.4pF	±0.05pF	GRM0335C2A5R4WA01#	
				±0.1pF	GRM0335C2A5R4BA01#	

T max.	Rated Voltage	TC Code	Cap.	Tol.	Part Number	
0.33mm	100Vdc	COG	5.4pF	±0.25pF	GRM0335C2A5R4CA01#	
				±0.5pF	GRM0335C2A5R4DA01#	
			5.5pF	±0.05pF	GRM0335C2A5R5WA01#	
				±0.1pF	GRM0335C2A5R5BA01#	
				±0.25pF	GRM0335C2A5R5CA01#	
				±0.5pF	GRM0335C2A5R5DA01#	
			5.6pF	±0.05pF	GRM0335C2A5R6WA01#	
				±0.1pF	GRM0335C2A5R6BA01#	
				±0.25pF	GRM0335C2A5R6CA01#	
				±0.5pF	GRM0335C2A5R6DA01#	
			5.7pF	±0.05pF	GRM0335C2A5R7WA01#	
				±0.1pF	GRM0335C2A5R7BA01#	
				±0.25pF	GRM0335C2A5R7CA01#	
				±0.5pF	GRM0335C2A5R7DA01#	
			5.8pF	±0.05pF	GRM0335C2A5R8WA01#	
				±0.1pF	GRM0335C2A5R8BA01#	
				±0.25pF	GRM0335C2A5R8CA01#	
				±0.5pF	GRM0335C2A5R8DA01#	
			5.9pF	±0.05pF	GRM0335C2A5R9WA01#	
				±0.1pF	GRM0335C2A5R9BA01#	
				±0.25pF	GRM0335C2A5R9CA01#	
				±0.5pF	GRM0335C2A5R9DA01#	
			6.0pF	±0.05pF	GRM0335C2A6R0WA01#	
				±0.1pF	GRM0335C2A6R0BA01#	
				±0.25pF	GRM0335C2A6R0CA01#	
				±0.5pF	GRM0335C2A6R0DA01#	
			6.1pF	±0.05pF	GRM0335C2A6R1WA01#	
				±0.1pF	GRM0335C2A6R1BA01#	
				±0.25pF	GRM0335C2A6R1CA01#	
			6.2pF	±0.05pF	GRM0335C2A6R2WA01#	
				±0.1pF	GRM0335C2A6R2BA01#	
				±0.25pF	GRM0335C2A6R2CA01#	
			±0.5pF	GRM0335C2A6R2DA01#		
				6.3pF	±0.05pF	GRM0335C2A6R3WA01#
					±0.1pF	GRM0335C2A6R3BA01#
			±0.25pF		GRM0335C2A6R3CA01#	
			±0.5pF		GRM0335C2A6R3DA01#	
			6.4pF	±0.05pF	GRM0335C2A6R4WA01#	
				±0.1pF	GRM0335C2A6R4BA01#	
				±0.25pF	GRM0335C2A6R4CA01#	
				±0.5pF	GRM0335C2A6R4DA01#	
			6.5pF	±0.05pF	GRM0335C2A6R5WA01#	
				±0.1pF	GRM0335C2A6R5BA01#	
				±0.25pF	GRM0335C2A6R5CA01#	
			±0.5pF	GRM0335C2A6R5DA01#		
				6.6pF	±0.05pF	GRM0335C2A6R6WA01#
					±0.1pF	GRM0335C2A6R6BA01#
			±0.25pF		GRM0335C2A6R6CA01#	
			±0.5pF	GRM0335C2A6R6DA01#		
				6.7pF	±0.05pF	GRM0335C2A6R7WA01#
					±0.1pF	GRM0335C2A6R7BA01#
			±0.25pF	GRM0335C2A6R7CA01#		
			±0.5pF	GRM0335C2A6R7DA01#		

- GRM
- GR3
- GRJ
- GR4
- GR7
- GJM
- GQM
- GA2
- GA3 GB
- GA3 GD
- GA3 GF
- LLL
- LLA
- LLM
- LLR
- NFM
- KRM
- KR3
- GMA
- GMD
- ⚠Caution /Notice

Part number # indicates the package specification code.

GRM Series Temperature Compensating Type Part Number List

(→ 0.6×0.3mm)

T max.	Rated Voltage	TC Code	Cap.	Tol.	Part Number
0.33mm	100Vdc	COG	6.8pF	±0.05pF	GRM0335C2A6R8WA01#
				±0.1pF	GRM0335C2A6R8BA01#
				±0.25pF	GRM0335C2A6R8CA01#
				±0.5pF	GRM0335C2A6R8DA01#
			6.9pF	±0.05pF	GRM0335C2A6R9WA01#
				±0.1pF	GRM0335C2A6R9BA01#
				±0.25pF	GRM0335C2A6R9CA01#
				±0.5pF	GRM0335C2A6R9DA01#
			7.0pF	±0.05pF	GRM0335C2A7R0WA01#
				±0.1pF	GRM0335C2A7R0BA01#
				±0.25pF	GRM0335C2A7R0CA01#
				±0.5pF	GRM0335C2A7R0DA01#
			7.1pF	±0.05pF	GRM0335C2A7R1WA01#
				±0.1pF	GRM0335C2A7R1BA01#
				±0.25pF	GRM0335C2A7R1CA01#
				±0.5pF	GRM0335C2A7R1DA01#
			7.2pF	±0.05pF	GRM0335C2A7R2WA01#
				±0.1pF	GRM0335C2A7R2BA01#
				±0.25pF	GRM0335C2A7R2CA01#
				±0.5pF	GRM0335C2A7R2DA01#
			7.3pF	±0.05pF	GRM0335C2A7R3WA01#
				±0.1pF	GRM0335C2A7R3BA01#
				±0.25pF	GRM0335C2A7R3CA01#
				±0.5pF	GRM0335C2A7R3DA01#
			7.4pF	±0.05pF	GRM0335C2A7R4WA01#
				±0.1pF	GRM0335C2A7R4BA01#
				±0.25pF	GRM0335C2A7R4CA01#
				±0.5pF	GRM0335C2A7R4DA01#
			7.5pF	±0.05pF	GRM0335C2A7R5WA01#
				±0.1pF	GRM0335C2A7R5BA01#
				±0.25pF	GRM0335C2A7R5CA01#
				±0.5pF	GRM0335C2A7R5DA01#
			7.6pF	±0.05pF	GRM0335C2A7R6WA01#
				±0.1pF	GRM0335C2A7R6BA01#
				±0.25pF	GRM0335C2A7R6CA01#
				±0.5pF	GRM0335C2A7R6DA01#
			7.7pF	±0.05pF	GRM0335C2A7R7WA01#
				±0.1pF	GRM0335C2A7R7BA01#
				±0.25pF	GRM0335C2A7R7CA01#
				±0.5pF	GRM0335C2A7R7DA01#
			7.8pF	±0.05pF	GRM0335C2A7R8WA01#
				±0.1pF	GRM0335C2A7R8BA01#
				±0.25pF	GRM0335C2A7R8CA01#
				±0.5pF	GRM0335C2A7R8DA01#
			7.9pF	±0.05pF	GRM0335C2A7R9WA01#
				±0.1pF	GRM0335C2A7R9BA01#
				±0.25pF	GRM0335C2A7R9CA01#
				±0.5pF	GRM0335C2A7R9DA01#
			8.0pF	±0.05pF	GRM0335C2A8R0WA01#
				±0.1pF	GRM0335C2A8R0BA01#
				±0.25pF	GRM0335C2A8R0CA01#
				±0.5pF	GRM0335C2A8R0DA01#
			8.1pF	±0.05pF	GRM0335C2A8R1WA01#
				±0.1pF	GRM0335C2A8R1BA01#

T max.	Rated Voltage	TC Code	Cap.	Tol.	Part Number
0.33mm	100Vdc	COG	8.1pF	±0.25pF	GRM0335C2A8R1CA01#
				±0.5pF	GRM0335C2A8R1DA01#
			8.2pF	±0.05pF	GRM0335C2A8R2WA01#
				±0.1pF	GRM0335C2A8R2BA01#
				±0.25pF	GRM0335C2A8R2CA01#
				±0.5pF	GRM0335C2A8R2DA01#
			8.3pF	±0.05pF	GRM0335C2A8R3WA01#
				±0.1pF	GRM0335C2A8R3BA01#
				±0.25pF	GRM0335C2A8R3CA01#
				±0.5pF	GRM0335C2A8R3DA01#
			8.4pF	±0.05pF	GRM0335C2A8R4WA01#
				±0.1pF	GRM0335C2A8R4BA01#
				±0.25pF	GRM0335C2A8R4CA01#
				±0.5pF	GRM0335C2A8R4DA01#
			8.5pF	±0.05pF	GRM0335C2A8R5WA01#
				±0.1pF	GRM0335C2A8R5BA01#
				±0.25pF	GRM0335C2A8R5CA01#
				±0.5pF	GRM0335C2A8R5DA01#
			8.6pF	±0.05pF	GRM0335C2A8R6WA01#
				±0.1pF	GRM0335C2A8R6BA01#
				±0.25pF	GRM0335C2A8R6CA01#
				±0.5pF	GRM0335C2A8R6DA01#
			8.7pF	±0.05pF	GRM0335C2A8R7WA01#
				±0.1pF	GRM0335C2A8R7BA01#
				±0.25pF	GRM0335C2A8R7CA01#
				±0.5pF	GRM0335C2A8R7DA01#
			8.8pF	±0.05pF	GRM0335C2A8R8WA01#
				±0.1pF	GRM0335C2A8R8BA01#
				±0.25pF	GRM0335C2A8R8CA01#
				±0.5pF	GRM0335C2A8R8DA01#
			8.9pF	±0.05pF	GRM0335C2A8R9WA01#
				±0.1pF	GRM0335C2A8R9BA01#
				±0.25pF	GRM0335C2A8R9CA01#
				±0.5pF	GRM0335C2A8R9DA01#
			9.0pF	±0.05pF	GRM0335C2A9R0WA01#
				±0.1pF	GRM0335C2A9R0BA01#
				±0.25pF	GRM0335C2A9R0CA01#
				±0.5pF	GRM0335C2A9R0DA01#
			9.1pF	±0.05pF	GRM0335C2A9R1WA01#
				±0.1pF	GRM0335C2A9R1BA01#
				±0.25pF	GRM0335C2A9R1CA01#
				±0.5pF	GRM0335C2A9R1DA01#
			9.2pF	±0.05pF	GRM0335C2A9R2WA01#
				±0.1pF	GRM0335C2A9R2BA01#
				±0.25pF	GRM0335C2A9R2CA01#
				±0.5pF	GRM0335C2A9R2DA01#
			9.3pF	±0.05pF	GRM0335C2A9R3WA01#
				±0.1pF	GRM0335C2A9R3BA01#
				±0.25pF	GRM0335C2A9R3CA01#
				±0.5pF	GRM0335C2A9R3DA01#
			9.4pF	±0.05pF	GRM0335C2A9R4WA01#
				±0.1pF	GRM0335C2A9R4BA01#
				±0.25pF	GRM0335C2A9R4CA01#
				±0.5pF	GRM0335C2A9R4DA01#

Part number # indicates the package specification code.

- GRM
- GR3
- GRJ
- GR4
- GR7
- GJM
- GQM
- GA2
- GA3 GB
- GA3 GD
- GA3 GF
- LLL
- LLA
- LLM
- LLR
- NFM
- KRM
- KR3
- GMA
- GMD
- ⚠Caution /Notice

GRM Series Temperature Compensating Type Part Number List

(→ 0.6×0.3mm)

T max.	Rated Voltage	TC Code	Cap.	Tol.	Part Number	T max.	Rated Voltage	TC Code	Cap.	Tol.	Part Number		
0.33mm	100Vdc	COG	9.5pF	±0.05pF	GRM0335C2A9R5WA01#	0.33mm	100Vdc	COG	68pF	±2%	GRM0335C2A680GA01#		
				±0.1pF	GRM0335C2A9R5BA01#					±5%	GRM0335C2A680JA01#		
				±0.25pF	GRM0335C2A9R5CA01#					75pF	±2%	GRM0335C2A750GA01#	
				±0.5pF	GRM0335C2A9R5DA01#						±5%	GRM0335C2A750JA01#	
			9.6pF	±0.05pF	GRM0335C2A9R6WA01#				82pF	±2%	GRM0335C2A820GA01#		
				±0.1pF	GRM0335C2A9R6BA01#					±5%	GRM0335C2A820JA01#		
				±0.25pF	GRM0335C2A9R6CA01#					91pF	±2%	GRM0335C2A910GA01#	
				±0.5pF	GRM0335C2A9R6DA01#						±5%	GRM0335C2A910JA01#	
			9.7pF	±0.05pF	GRM0335C2A9R7WA01#				100pF	±2%	GRM0335C2A101GA01#		
				±0.1pF	GRM0335C2A9R7BA01#					±5%	GRM0335C2A101JA01#		
				±0.25pF	GRM0335C2A9R7CA01#						CK	0.10pF	±0.05pF
				±0.5pF	GRM0335C2A9R7DA01#					0.20pF		±0.05pF	GRM0334C2AR20WA01#
			9.8pF	±0.05pF	GRM0335C2A9R8WA01#				0.30pF	±0.1pF	GRM0334C2AR20BA01#		
				±0.1pF	GRM0335C2A9R8BA01#					0.40pF	±0.05pF	GRM0334C2AR30WA01#	
				±0.25pF	GRM0335C2A9R8CA01#						±0.1pF	GRM0334C2AR30BA01#	
				±0.5pF	GRM0335C2A9R8DA01#					0.50pF	±0.05pF	GRM0334C2AR40WA01#	
			9.9pF	±0.05pF	GRM0335C2A9R9WA01#				±0.1pF		GRM0334C2AR40BA01#		
				±0.1pF	GRM0335C2A9R9BA01#				0.60pF	±0.05pF	GRM0334C2AR50WA01#		
				±0.25pF	GRM0335C2A9R9CA01#					±0.1pF	GRM0334C2AR50BA01#		
				±0.5pF	GRM0335C2A9R9DA01#				0.70pF	±0.05pF	GRM0334C2AR60WA01#		
			10pF	±2%	GRM0335C2A100GA01#					±0.1pF	GRM0334C2AR60BA01#		
				±5%	GRM0335C2A100JA01#				0.80pF	±0.05pF	GRM0334C2AR70WA01#		
				12pF	±2%					GRM0335C2A120GA01#	±0.1pF	GRM0334C2AR70BA01#	
					±5%				GRM0335C2A120JA01#	0.90pF	±0.05pF	GRM0334C2AR80WA01#	
			15pF	±2%	GRM0335C2A150GA01#				±0.1pF		GRM0334C2AR80BA01#		
				±5%	GRM0335C2A150JA01#				1.0pF	±0.05pF	GRM0334C2AR90WA01#		
			18pF	±2%	GRM0335C2A180GA01#					±0.1pF	GRM0334C2AR90BA01#		
				±5%	GRM0335C2A180JA01#				1.1pF	±0.05pF	GRM0334C2A1R0WA01#		
			20pF	±2%	GRM0335C2A200GA01#					±0.1pF	GRM0334C2A1R0BA01#		
				±5%	GRM0335C2A200JA01#				±0.25pF	GRM0334C2A1R0CA01#			
			22pF	±2%	GRM0335C2A220GA01#				1.2pF	±0.05pF	GRM0334C2A1R1WA01#		
				±5%	GRM0335C2A220JA01#					±0.1pF	GRM0334C2A1R1BA01#		
			24pF	±2%	GRM0335C2A240GA01#				±0.25pF	GRM0334C2A1R1CA01#			
				±5%	GRM0335C2A240JA01#				1.3pF	±0.05pF	GRM0334C2A1R2WA01#		
			27pF	±2%	GRM0335C2A270GA01#					±0.1pF	GRM0334C2A1R2BA01#		
				±5%	GRM0335C2A270JA01#				±0.25pF	GRM0334C2A1R2CA01#			
			30pF	±2%	GRM0335C2A300GA01#				1.4pF	±0.05pF	GRM0334C2A1R3WA01#		
				±5%	GRM0335C2A300JA01#					±0.1pF	GRM0334C2A1R3BA01#		
			33pF	±2%	GRM0335C2A330GA01#				±0.25pF	GRM0334C2A1R3CA01#			
				±5%	GRM0335C2A330JA01#				1.5pF	±0.05pF	GRM0334C2A1R4WA01#		
			36pF	±2%	GRM0335C2A360GA01#					±0.1pF	GRM0334C2A1R4BA01#		
				±5%	GRM0335C2A360JA01#				±0.25pF	GRM0334C2A1R4CA01#			
			39pF	±2%	GRM0335C2A390GA01#				1.6pF	±0.05pF	GRM0334C2A1R5WA01#		
				±5%	GRM0335C2A390JA01#					±0.1pF	GRM0334C2A1R5BA01#		
			43pF	±2%	GRM0335C2A430GA01#				±0.25pF	GRM0334C2A1R5CA01#			
				±5%	GRM0335C2A430JA01#				1.7pF	±0.05pF	GRM0334C2A1R6WA01#		
			47pF	±2%	GRM0335C2A470GA01#					±0.1pF	GRM0334C2A1R6BA01#		
				±5%	GRM0335C2A470JA01#				±0.25pF	GRM0334C2A1R6CA01#			
			51pF	±2%	GRM0335C2A510GA01#				1.8pF	±0.05pF	GRM0334C2A1R7WA01#		
				±5%	GRM0335C2A510JA01#					±0.1pF	GRM0334C2A1R7BA01#		
			56pF	±2%	GRM0335C2A560GA01#				±0.25pF	GRM0334C2A1R7CA01#			
				±5%	GRM0335C2A560JA01#				±0.05pF	±0.05pF	GRM0334C2A1R8WA01#		
62pF	±2%	GRM0335C2A620GA01#	±0.1pF	GRM0334C2A1R8BA01#									
	±5%	GRM0335C2A620JA01#	±0.25pF	GRM0334C2A1R8CA01#									

GRM
 GR3
 GRJ
 GR4
 GR7
 GJM
 GQM
 GA2
 GA3 GB
 GA3 GD
 GA3 GF
 LLL
 LLA
 LLM
 LLR
 NFM
 KRM
 KR3
 GMA
 GMD
 ⚠Caution /Notice

Part number # indicates the package specification code.

GRM Series Temperature Compensating Type Part Number List

(→ 0.6×0.3mm)

T max.	Rated Voltage	TC Code	Cap.	Tol.	Part Number	T max.	Rated Voltage	TC Code	Cap.	Tol.	Part Number			
0.33mm	100Vdc	CK	1.9pF	±0.05pF	GRM0334C2A1R9WA01#	0.33mm	100Vdc	CJ	3.7pF	±0.05pF	GRM0333C2A3R7WA01#			
				±0.1pF	GRM0334C2A1R9BA01#					±0.1pF	GRM0333C2A3R7BA01#			
				±0.25pF	GRM0334C2A1R9CA01#					±0.25pF	GRM0333C2A3R7CA01#			
			2.0pF	±0.05pF	GRM0334C2A2R0WA01#					3.8pF	±0.05pF	GRM0333C2A3R8WA01#		
				±0.1pF	GRM0334C2A2R0BA01#						±0.1pF	GRM0333C2A3R8BA01#		
				±0.25pF	GRM0334C2A2R0CA01#						±0.25pF	GRM0333C2A3R8CA01#		
			2.1pF	±0.05pF	GRM0333C2A2R1WA01#						3.9pF	±0.05pF	GRM0333C2A3R9WA01#	
				±0.1pF	GRM0333C2A2R1BA01#							±0.1pF	GRM0333C2A3R9BA01#	
				±0.25pF	GRM0333C2A2R1CA01#							±0.25pF	GRM0333C2A3R9CA01#	
			2.2pF	±0.05pF	GRM0333C2A2R2WA01#				4.0pF			±0.05pF	GRM0332C2A4R0WA01#	
				±0.1pF	GRM0333C2A2R2BA01#							±0.1pF	GRM0332C2A4R0BA01#	
				±0.25pF	GRM0333C2A2R2CA01#							±0.25pF	GRM0332C2A4R0CA01#	
			2.3pF	±0.05pF	GRM0333C2A2R3WA01#					4.1pF		±0.05pF	GRM0332C2A4R1WA01#	
				±0.1pF	GRM0333C2A2R3BA01#							±0.1pF	GRM0332C2A4R1BA01#	
				±0.25pF	GRM0333C2A2R3CA01#							±0.25pF	GRM0332C2A4R1CA01#	
			2.4pF	±0.05pF	GRM0333C2A2R4WA01#						4.2pF	±0.05pF	GRM0332C2A4R2WA01#	
				±0.1pF	GRM0333C2A2R4BA01#							±0.1pF	GRM0332C2A4R2BA01#	
				±0.25pF	GRM0333C2A2R4CA01#							±0.25pF	GRM0332C2A4R2CA01#	
			2.5pF	±0.05pF	GRM0333C2A2R5WA01#				4.3pF			±0.05pF	GRM0332C2A4R3WA01#	
				±0.1pF	GRM0333C2A2R5BA01#							±0.1pF	GRM0332C2A4R3BA01#	
				±0.25pF	GRM0333C2A2R5CA01#							±0.25pF	GRM0332C2A4R3CA01#	
			2.6pF	±0.05pF	GRM0333C2A2R6WA01#					4.4pF		±0.05pF	GRM0332C2A4R4WA01#	
				±0.1pF	GRM0333C2A2R6BA01#							±0.1pF	GRM0332C2A4R4BA01#	
				±0.25pF	GRM0333C2A2R6CA01#							±0.25pF	GRM0332C2A4R4CA01#	
			2.7pF	±0.05pF	GRM0333C2A2R7WA01#						4.5pF	±0.05pF	GRM0332C2A4R5WA01#	
				±0.1pF	GRM0333C2A2R7BA01#							±0.1pF	GRM0332C2A4R5BA01#	
				±0.25pF	GRM0333C2A2R7CA01#							±0.25pF	GRM0332C2A4R5CA01#	
			2.8pF	±0.05pF	GRM0333C2A2R8WA01#				4.6pF			±0.05pF	GRM0332C2A4R6WA01#	
				±0.1pF	GRM0333C2A2R8BA01#							±0.1pF	GRM0332C2A4R6BA01#	
				±0.25pF	GRM0333C2A2R8CA01#							±0.25pF	GRM0332C2A4R6CA01#	
			2.9pF	±0.05pF	GRM0333C2A2R9WA01#					4.7pF		±0.05pF	GRM0332C2A4R7WA01#	
				±0.1pF	GRM0333C2A2R9BA01#							±0.1pF	GRM0332C2A4R7BA01#	
				±0.25pF	GRM0333C2A2R9CA01#							±0.25pF	GRM0332C2A4R7CA01#	
			3.0pF	±0.05pF	GRM0333C2A3R0WA01#						4.8pF	±0.05pF	GRM0332C2A4R8WA01#	
				±0.1pF	GRM0333C2A3R0BA01#							±0.1pF	GRM0332C2A4R8BA01#	
				±0.25pF	GRM0333C2A3R0CA01#							±0.25pF	GRM0332C2A4R8CA01#	
		3.1pF	±0.05pF	GRM0333C2A3R1WA01#	4.9pF	±0.05pF	GRM0332C2A4R9WA01#							
			±0.1pF	GRM0333C2A3R1BA01#		±0.1pF	GRM0332C2A4R9BA01#							
			±0.25pF	GRM0333C2A3R1CA01#		±0.25pF	GRM0332C2A4R9CA01#							
		3.2pF	±0.05pF	GRM0333C2A3R2WA01#		5.0pF	±0.05pF	GRM0332C2A5R0WA01#						
			±0.1pF	GRM0333C2A3R2BA01#			±0.1pF	GRM0332C2A5R0BA01#						
			±0.25pF	GRM0333C2A3R2CA01#			±0.25pF	GRM0332C2A5R0CA01#						
		3.3pF	±0.05pF	GRM0333C2A3R3WA01#			5.1pF	±0.05pF	GRM0332C2A5R1WA01#					
			±0.1pF	GRM0333C2A3R3BA01#				±0.1pF	GRM0332C2A5R1BA01#					
			±0.25pF	GRM0333C2A3R3CA01#				±0.25pF	GRM0332C2A5R1CA01#					
		3.4pF	±0.05pF	GRM0333C2A3R4WA01#	5.2pF			±0.05pF	GRM0332C2A5R2WA01#					
			±0.1pF	GRM0333C2A3R4BA01#				±0.1pF	GRM0332C2A5R2BA01#					
			±0.25pF	GRM0333C2A3R4CA01#				±0.25pF	GRM0332C2A5R2CA01#					
		3.5pF	±0.05pF	GRM0333C2A3R5WA01#		5.3pF		±0.05pF	GRM0332C2A5R3WA01#					
			±0.1pF	GRM0333C2A3R5BA01#				±0.1pF	GRM0332C2A5R3BA01#					
			±0.25pF	GRM0333C2A3R5CA01#				±0.25pF	GRM0332C2A5R3CA01#					
		3.6pF	±0.05pF	GRM0333C2A3R6WA01#			5.3pF	±0.05pF	GRM0332C2A5R3WA01#					
			±0.1pF	GRM0333C2A3R6BA01#				±0.1pF	GRM0332C2A5R3BA01#					
			±0.25pF	GRM0333C2A3R6CA01#				±0.25pF	GRM0332C2A5R3CA01#					
													±0.5pF	GRM0332C2A5R3DA01#

Part number # indicates the package specification code.

- GRM
- GR3
- GRJ
- GR4
- GR7
- GJM
- GQM
- GA2
- GA3 GB
- GA3 GD
- GA3 GF
- LLL
- LLA
- LLM
- LLR
- NFM
- KRM
- KR3
- GMA
- GMD
- ⚠Caution /Notice

GRM Series Temperature Compensating Type Part Number List

(→ 0.6×0.3mm)

T max.	Rated Voltage	TC Code	Cap.	Tol.	Part Number
0.33mm	100Vdc	CH	5.4pF	±0.05pF	GRM0332C2A5R4WA01#
				±0.1pF	GRM0332C2A5R4BA01#
				±0.25pF	GRM0332C2A5R4CA01#
				±0.5pF	GRM0332C2A5R4DA01#
			5.5pF	±0.05pF	GRM0332C2A5R5WA01#
				±0.1pF	GRM0332C2A5R5BA01#
				±0.25pF	GRM0332C2A5R5CA01#
				±0.5pF	GRM0332C2A5R5DA01#
			5.6pF	±0.05pF	GRM0332C2A5R6WA01#
				±0.1pF	GRM0332C2A5R6BA01#
				±0.25pF	GRM0332C2A5R6CA01#
				±0.5pF	GRM0332C2A5R6DA01#
			5.7pF	±0.05pF	GRM0332C2A5R7WA01#
				±0.1pF	GRM0332C2A5R7BA01#
				±0.25pF	GRM0332C2A5R7CA01#
				±0.5pF	GRM0332C2A5R7DA01#
			5.8pF	±0.05pF	GRM0332C2A5R8WA01#
				±0.1pF	GRM0332C2A5R8BA01#
				±0.25pF	GRM0332C2A5R8CA01#
				±0.5pF	GRM0332C2A5R8DA01#
			5.9pF	±0.05pF	GRM0332C2A5R9WA01#
				±0.1pF	GRM0332C2A5R9BA01#
				±0.25pF	GRM0332C2A5R9CA01#
				±0.5pF	GRM0332C2A5R9DA01#
			6.0pF	±0.05pF	GRM0332C2A6R0WA01#
				±0.1pF	GRM0332C2A6R0BA01#
				±0.25pF	GRM0332C2A6R0CA01#
				±0.5pF	GRM0332C2A6R0DA01#
			6.1pF	±0.05pF	GRM0332C2A6R1WA01#
				±0.1pF	GRM0332C2A6R1BA01#
				±0.25pF	GRM0332C2A6R1CA01#
				±0.5pF	GRM0332C2A6R1DA01#
			6.2pF	±0.05pF	GRM0332C2A6R2WA01#
				±0.1pF	GRM0332C2A6R2BA01#
				±0.25pF	GRM0332C2A6R2CA01#
				±0.5pF	GRM0332C2A6R2DA01#
			6.3pF	±0.05pF	GRM0332C2A6R3WA01#
				±0.1pF	GRM0332C2A6R3BA01#
				±0.25pF	GRM0332C2A6R3CA01#
				±0.5pF	GRM0332C2A6R3DA01#
			6.4pF	±0.05pF	GRM0332C2A6R4WA01#
				±0.1pF	GRM0332C2A6R4BA01#
				±0.25pF	GRM0332C2A6R4CA01#
				±0.5pF	GRM0332C2A6R4DA01#
			6.5pF	±0.05pF	GRM0332C2A6R5WA01#
				±0.1pF	GRM0332C2A6R5BA01#
				±0.25pF	GRM0332C2A6R5CA01#
				±0.5pF	GRM0332C2A6R5DA01#
			6.6pF	±0.05pF	GRM0332C2A6R6WA01#
				±0.1pF	GRM0332C2A6R6BA01#
				±0.25pF	GRM0332C2A6R6CA01#
				±0.5pF	GRM0332C2A6R6DA01#
			6.7pF	±0.05pF	GRM0332C2A6R7WA01#
				±0.1pF	GRM0332C2A6R7BA01#

T max.	Rated Voltage	TC Code	Cap.	Tol.	Part Number
0.33mm	100Vdc	CH	6.7pF	±0.25pF	GRM0332C2A6R7CA01#
				±0.5pF	GRM0332C2A6R7DA01#
			6.8pF	±0.05pF	GRM0332C2A6R8WA01#
				±0.1pF	GRM0332C2A6R8BA01#
				±0.25pF	GRM0332C2A6R8CA01#
			6.9pF	±0.05pF	GRM0332C2A6R9WA01#
				±0.1pF	GRM0332C2A6R9BA01#
				±0.25pF	GRM0332C2A6R9CA01#
			7.0pF	±0.05pF	GRM0332C2A7R0WA01#
				±0.1pF	GRM0332C2A7R0BA01#
				±0.25pF	GRM0332C2A7R0CA01#
			7.1pF	±0.05pF	GRM0332C2A7R1WA01#
				±0.1pF	GRM0332C2A7R1BA01#
				±0.25pF	GRM0332C2A7R1CA01#
			7.2pF	±0.05pF	GRM0332C2A7R2WA01#
				±0.1pF	GRM0332C2A7R2BA01#
				±0.25pF	GRM0332C2A7R2CA01#
			7.3pF	±0.05pF	GRM0332C2A7R3WA01#
				±0.1pF	GRM0332C2A7R3BA01#
				±0.25pF	GRM0332C2A7R3CA01#
			7.4pF	±0.05pF	GRM0332C2A7R4WA01#
				±0.1pF	GRM0332C2A7R4BA01#
				±0.25pF	GRM0332C2A7R4CA01#
			7.5pF	±0.05pF	GRM0332C2A7R5WA01#
				±0.1pF	GRM0332C2A7R5BA01#
				±0.25pF	GRM0332C2A7R5CA01#
			7.6pF	±0.05pF	GRM0332C2A7R6WA01#
				±0.1pF	GRM0332C2A7R6BA01#
				±0.25pF	GRM0332C2A7R6CA01#
			7.7pF	±0.05pF	GRM0332C2A7R7WA01#
				±0.1pF	GRM0332C2A7R7BA01#
				±0.25pF	GRM0332C2A7R7CA01#
			7.8pF	±0.05pF	GRM0332C2A7R8WA01#
				±0.1pF	GRM0332C2A7R8BA01#
				±0.25pF	GRM0332C2A7R8CA01#
			7.9pF	±0.05pF	GRM0332C2A7R9WA01#
				±0.1pF	GRM0332C2A7R9BA01#
				±0.25pF	GRM0332C2A7R9CA01#
			8.0pF	±0.05pF	GRM0332C2A8R0WA01#
				±0.1pF	GRM0332C2A8R0BA01#
				±0.25pF	GRM0332C2A8R0CA01#

- GRM
- GR3
- GRJ
- GR4
- GR7
- GJM
- GQM
- GA2
- GA3 GB
- GA3 GD
- GA3 GF
- LLL
- LLA
- LLM
- LLR
- NFM
- KRM
- KR3
- GMA
- GMD
- ⚠Caution /Notice

Part number # indicates the package specification code.

GRM Series Temperature Compensating Type Part Number List

(→ 0.6×0.3mm)

T max.	Rated Voltage	TC Code	Cap.	Tol.	Part Number
0.33mm	100Vdc	CH	8.1pF	±0.05pF	GRM0332C2A8R1WA01#
				±0.1pF	GRM0332C2A8R1BA01#
				±0.25pF	GRM0332C2A8R1CA01#
				±0.5pF	GRM0332C2A8R1DA01#
			8.2pF	±0.05pF	GRM0332C2A8R2WA01#
				±0.1pF	GRM0332C2A8R2BA01#
				±0.25pF	GRM0332C2A8R2CA01#
				±0.5pF	GRM0332C2A8R2DA01#
			8.3pF	±0.05pF	GRM0332C2A8R3WA01#
				±0.1pF	GRM0332C2A8R3BA01#
				±0.25pF	GRM0332C2A8R3CA01#
				±0.5pF	GRM0332C2A8R3DA01#
			8.4pF	±0.05pF	GRM0332C2A8R4WA01#
				±0.1pF	GRM0332C2A8R4BA01#
				±0.25pF	GRM0332C2A8R4CA01#
				±0.5pF	GRM0332C2A8R4DA01#
			8.5pF	±0.05pF	GRM0332C2A8R5WA01#
				±0.1pF	GRM0332C2A8R5BA01#
				±0.25pF	GRM0332C2A8R5CA01#
				±0.5pF	GRM0332C2A8R5DA01#
			8.6pF	±0.05pF	GRM0332C2A8R6WA01#
				±0.1pF	GRM0332C2A8R6BA01#
				±0.25pF	GRM0332C2A8R6CA01#
				±0.5pF	GRM0332C2A8R6DA01#
			8.7pF	±0.05pF	GRM0332C2A8R7WA01#
				±0.1pF	GRM0332C2A8R7BA01#
				±0.25pF	GRM0332C2A8R7CA01#
				±0.5pF	GRM0332C2A8R7DA01#
			8.8pF	±0.05pF	GRM0332C2A8R8WA01#
				±0.1pF	GRM0332C2A8R8BA01#
				±0.25pF	GRM0332C2A8R8CA01#
				±0.5pF	GRM0332C2A8R8DA01#
			8.9pF	±0.05pF	GRM0332C2A8R9WA01#
				±0.1pF	GRM0332C2A8R9BA01#
				±0.25pF	GRM0332C2A8R9CA01#
				±0.5pF	GRM0332C2A8R9DA01#
			9.0pF	±0.05pF	GRM0332C2A9R0WA01#
				±0.1pF	GRM0332C2A9R0BA01#
				±0.25pF	GRM0332C2A9R0CA01#
				±0.5pF	GRM0332C2A9R0DA01#
			9.1pF	±0.05pF	GRM0332C2A9R1WA01#
				±0.1pF	GRM0332C2A9R1BA01#
				±0.25pF	GRM0332C2A9R1CA01#
				±0.5pF	GRM0332C2A9R1DA01#
			9.2pF	±0.05pF	GRM0332C2A9R2WA01#
				±0.1pF	GRM0332C2A9R2BA01#
				±0.25pF	GRM0332C2A9R2CA01#
				±0.5pF	GRM0332C2A9R2DA01#
			9.3pF	±0.05pF	GRM0332C2A9R3WA01#
				±0.1pF	GRM0332C2A9R3BA01#
				±0.25pF	GRM0332C2A9R3CA01#
				±0.5pF	GRM0332C2A9R3DA01#
			9.4pF	±0.05pF	GRM0332C2A9R4WA01#
				±0.1pF	GRM0332C2A9R4BA01#

T max.	Rated Voltage	TC Code	Cap.	Tol.	Part Number
0.33mm	100Vdc	CH	9.4pF	±0.25pF	GRM0332C2A9R4CA01#
				±0.5pF	GRM0332C2A9R4DA01#
			9.5pF	±0.05pF	GRM0332C2A9R5WA01#
				±0.1pF	GRM0332C2A9R5BA01#
				±0.25pF	GRM0332C2A9R5CA01#
			9.6pF	±0.05pF	GRM0332C2A9R6WA01#
				±0.1pF	GRM0332C2A9R6BA01#
				±0.25pF	GRM0332C2A9R6CA01#
			9.7pF	±0.05pF	GRM0332C2A9R7WA01#
				±0.1pF	GRM0332C2A9R7BA01#
				±0.25pF	GRM0332C2A9R7CA01#
			9.8pF	±0.05pF	GRM0332C2A9R8WA01#
				±0.1pF	GRM0332C2A9R8BA01#
				±0.25pF	GRM0332C2A9R8CA01#
			9.9pF	±0.05pF	GRM0332C2A9R9WA01#
				±0.1pF	GRM0332C2A9R9BA01#
				±0.25pF	GRM0332C2A9R9CA01#
			10pF	±2%	GRM0332C2A100GA01#
				±5%	GRM0332C2A100JA01#
			12pF	±2%	GRM0332C2A120GA01#
				±5%	GRM0332C2A120JA01#
			15pF	±2%	GRM0332C2A150GA01#
				±5%	GRM0332C2A150JA01#
			18pF	±2%	GRM0332C2A180GA01#
				±5%	GRM0332C2A180JA01#
			20pF	±2%	GRM0332C2A200GA01#
				±5%	GRM0332C2A200JA01#
			22pF	±2%	GRM0332C2A220GA01#
				±5%	GRM0332C2A220JA01#
			24pF	±2%	GRM0332C2A240GA01#
				±5%	GRM0332C2A240JA01#
			27pF	±2%	GRM0332C2A270GA01#
				±5%	GRM0332C2A270JA01#
			30pF	±2%	GRM0332C2A300GA01#
				±5%	GRM0332C2A300JA01#
			33pF	±2%	GRM0332C2A330GA01#
				±5%	GRM0332C2A330JA01#
			36pF	±2%	GRM0332C2A360GA01#
				±5%	GRM0332C2A360JA01#
			39pF	±2%	GRM0332C2A390GA01#
				±5%	GRM0332C2A390JA01#
			43pF	±2%	GRM0332C2A430GA01#
				±5%	GRM0332C2A430JA01#
			47pF	±2%	GRM0332C2A470GA01#
				±5%	GRM0332C2A470JA01#
			51pF	±2%	GRM0332C2A510GA01#
				±5%	GRM0332C2A510JA01#
			56pF	±2%	GRM0332C2A560GA01#
				±5%	GRM0332C2A560JA01#

Part number # indicates the package specification code.



GRM Series Temperature Compensating Type Part Number List

(→ 0.6×0.3mm)

T max.	Rated Voltage	TC Code	Cap.	Tol.	Part Number	T max.	Rated Voltage	TC Code	Cap.	Tol.	Part Number			
0.33mm	100Vdc	CH	62pF	±2%	GRM0332C2A620GA01#	0.33mm	50Vdc	COG	1.8pF	±0.1pF	GRM0335C1H1R8BA01#			
				±5%	GRM0332C2A620JA01#					±0.25pF	GRM0335C1H1R8CA01#			
			68pF	±2%	GRM0332C2A680GA01#				1.9pF	±0.05pF	GRM0335C1H1R9WA01#			
				±5%	GRM0332C2A680JA01#					±0.1pF	GRM0335C1H1R9BA01#			
			75pF	±2%	GRM0332C2A750GA01#				2.0pF	±0.25pF	GRM0335C1H1R9CA01#			
				±5%	GRM0332C2A750JA01#					±0.05pF	GRM0335C1H2R0WA01#			
			82pF	±2%	GRM0332C2A820GA01#				2.1pF	±0.1pF	GRM0335C1H2R0BA01#			
				±5%	GRM0332C2A820JA01#					±0.25pF	GRM0335C1H2R0CA01#			
			91pF	±2%	GRM0332C2A910GA01#				2.1pF	±0.05pF	GRM0335C1H2R1WA01#			
				±5%	GRM0332C2A910JA01#					±0.1pF	GRM0335C1H2R1BA01#			
			100pF	±2%	GRM0332C2A101GA01#				2.1pF	±0.25pF	GRM0335C1H2R1CA01#			
				±5%	GRM0332C2A101JA01#					±0.05pF	GRM0335C1H2R2WA01#			
	50Vdc	COG	0.10pF	±0.05pF	GRM0335C1HR10WA01#				0.33mm	50Vdc	COG	2.2pF	±0.1pF	GRM0335C1H2R2BA01#
				±0.1pF	GRM0335C1HR20BA01#								±0.25pF	GRM0335C1H2R2CA01#
			0.20pF	±0.05pF	GRM0335C1HR20WA01#							2.3pF	±0.05pF	GRM0335C1H2R3WA01#
				±0.1pF	GRM0335C1HR20BA01#								±0.1pF	GRM0335C1H2R3BA01#
			0.30pF	±0.05pF	GRM0335C1HR30WA01#							2.3pF	±0.25pF	GRM0335C1H2R3CA01#
				±0.1pF	GRM0335C1HR30BA01#								±0.05pF	GRM0335C1H2R4WA01#
			0.40pF	±0.05pF	GRM0335C1HR40WA01#							2.4pF	±0.1pF	GRM0335C1H2R4BA01#
				±0.1pF	GRM0335C1HR40BA01#								±0.25pF	GRM0335C1H2R4CA01#
			0.50pF	±0.05pF	GRM0335C1HR50WA01#							2.4pF	±0.1pF	GRM0335C1H2R4BA01#
				±0.1pF	GRM0335C1HR50BA01#								±0.25pF	GRM0335C1H2R4CA01#
			0.60pF	±0.05pF	GRM0335C1HR60WA01#							2.5pF	±0.05pF	GRM0335C1H2R5WA01#
				±0.1pF	GRM0335C1HR60BA01#								±0.1pF	GRM0335C1H2R5BA01#
0.70pF			±0.05pF	GRM0335C1HR70WA01#	2.5pF	±0.25pF	GRM0335C1H2R5CA01#							
			±0.1pF	GRM0335C1HR70BA01#		±0.05pF	GRM0335C1H2R6WA01#							
0.80pF			±0.05pF	GRM0335C1HR80WA01#	2.6pF	±0.1pF	GRM0335C1H2R6BA01#							
			±0.1pF	GRM0335C1HR80BA01#		±0.25pF	GRM0335C1H2R6CA01#							
0.90pF			±0.05pF	GRM0335C1HR90WA01#	2.6pF	±0.1pF	GRM0335C1H2R6BA01#							
			±0.1pF	GRM0335C1HR90BA01#		±0.25pF	GRM0335C1H2R7WA01#							
1.0pF			±0.05pF	GRM0335C1H1R0WA01#	2.7pF	±0.05pF	GRM0335C1H2R7WA01#							
			±0.1pF	GRM0335C1H1R0BA01#		±0.1pF	GRM0335C1H2R7BA01#							
			±0.25pF	GRM0335C1H1R0CA01#		±0.25pF	GRM0335C1H2R7CA01#							
1.1pF			±0.05pF	GRM0335C1H1R1WA01#	2.8pF	±0.05pF	GRM0335C1H2R8WA01#							
			±0.1pF	GRM0335C1H1R1BA01#		±0.1pF	GRM0335C1H2R8BA01#							
			±0.25pF	GRM0335C1H1R1CA01#		±0.25pF	GRM0335C1H2R8CA01#							
1.2pF	±0.05pF	GRM0335C1H1R2WA01#	2.8pF	±0.1pF	GRM0335C1H2R8BA01#									
	±0.1pF	GRM0335C1H1R2BA01#		±0.25pF	GRM0335C1H2R9WA01#									
	±0.25pF	GRM0335C1H1R2CA01#		±0.1pF	GRM0335C1H2R9BA01#									
1.3pF	±0.05pF	GRM0335C1H1R3WA01#	2.9pF	±0.25pF	GRM0335C1H2R9CA01#									
	±0.1pF	GRM0335C1H1R3BA01#		±0.05pF	GRM0335C1H3R0WA01#									
	±0.25pF	GRM0335C1H1R3CA01#		±0.1pF	GRM0335C1H3R0BA01#									
1.4pF	±0.05pF	GRM0335C1H1R4WA01#	3.0pF	±0.25pF	GRM0335C1H3R0CA01#									
	±0.1pF	GRM0335C1H1R4BA01#		±0.05pF	GRM0335C1H3R1WA01#									
	±0.25pF	GRM0335C1H1R4CA01#		±0.1pF	GRM0335C1H3R1BA01#									
1.5pF	±0.05pF	GRM0335C1H1R5WA01#	3.1pF	±0.25pF	GRM0335C1H3R1CA01#									
	±0.1pF	GRM0335C1H1R5BA01#		±0.05pF	GRM0335C1H3R2WA01#									
	±0.25pF	GRM0335C1H1R5CA01#		±0.1pF	GRM0335C1H3R2BA01#									
1.6pF	±0.05pF	GRM0335C1H1R6WA01#	3.2pF	±0.25pF	GRM0335C1H3R2CA01#									
	±0.1pF	GRM0335C1H1R6BA01#		±0.05pF	GRM0335C1H3R3WA01#									
	±0.25pF	GRM0335C1H1R6CA01#		±0.1pF	GRM0335C1H3R3BA01#									
1.7pF	±0.05pF	GRM0335C1H1R7WA01#	3.3pF	±0.25pF	GRM0335C1H3R3CA01#									
	±0.1pF	GRM0335C1H1R7BA01#		±0.05pF	GRM0335C1H3R4WA01#									
	±0.25pF	GRM0335C1H1R7CA01#		±0.1pF	GRM0335C1H3R4BA01#									
1.8pF	±0.05pF	GRM0335C1H1R8WA01#	3.4pF	±0.25pF	GRM0335C1H3R4CA01#									
	±0.1pF	GRM0335C1H1R8BA01#		±0.05pF	GRM0335C1H3R5WA01#									
	±0.25pF	GRM0335C1H1R8CA01#		±0.1pF	GRM0335C1H3R5BA01#									
						3.5pF	±0.05pF	GRM0335C1H3R5WA01#	±0.1pF	GRM0335C1H3R5BA01#				
						3.5pF	±0.1pF	GRM0335C1H3R5BA01#	±0.25pF	GRM0335C1H3R5CA01#				
						3.6pF	±0.05pF	GRM0335C1H3R6WA01#						

- GRM
- GR3
- GRJ
- GR4
- GR7
- GJM
- GQM
- GA2
- GA3 GB
- GA3 GD
- GA3 GF
- LLL
- LLA
- LLM
- LLR
- NFM
- KRM
- KR3
- GMA
- GMD
- ⚠Caution /Notice

Part number # indicates the package specification code.

GRM Series Temperature Compensating Type Part Number List

(→ 0.6×0.3mm)

T max.	Rated Voltage	TC Code	Cap.	Tol.	Part Number
0.33mm	50Vdc	COG	3.6pF	±0.1pF	GRM0335C1H3R6BA01#
				±0.25pF	GRM0335C1H3R6CA01#
			3.7pF	±0.05pF	GRM0335C1H3R7WA01#
				±0.1pF	GRM0335C1H3R7BA01#
				±0.25pF	GRM0335C1H3R7CA01#
			3.8pF	±0.05pF	GRM0335C1H3R8WA01#
				±0.1pF	GRM0335C1H3R8BA01#
				±0.25pF	GRM0335C1H3R8CA01#
			3.9pF	±0.05pF	GRM0335C1H3R9WA01#
				±0.1pF	GRM0335C1H3R9BA01#
				±0.25pF	GRM0335C1H3R9CA01#
			4.0pF	±0.05pF	GRM0335C1H4R0WA01#
				±0.1pF	GRM0335C1H4R0BA01#
				±0.25pF	GRM0335C1H4R0CA01#
			4.1pF	±0.05pF	GRM0335C1H4R1WA01#
				±0.1pF	GRM0335C1H4R1BA01#
				±0.25pF	GRM0335C1H4R1CA01#
			4.2pF	±0.05pF	GRM0335C1H4R2WA01#
				±0.1pF	GRM0335C1H4R2BA01#
				±0.25pF	GRM0335C1H4R2CA01#
			4.3pF	±0.05pF	GRM0335C1H4R3WA01#
				±0.1pF	GRM0335C1H4R3BA01#
				±0.25pF	GRM0335C1H4R3CA01#
			4.4pF	±0.05pF	GRM0335C1H4R4WA01#
				±0.1pF	GRM0335C1H4R4BA01#
				±0.25pF	GRM0335C1H4R4CA01#
			4.5pF	±0.05pF	GRM0335C1H4R5WA01#
				±0.1pF	GRM0335C1H4R5BA01#
				±0.25pF	GRM0335C1H4R5CA01#
			4.6pF	±0.05pF	GRM0335C1H4R6WA01#
				±0.1pF	GRM0335C1H4R6BA01#
				±0.25pF	GRM0335C1H4R6CA01#
			4.7pF	±0.05pF	GRM0335C1H4R7WA01#
				±0.1pF	GRM0335C1H4R7BA01#
				±0.25pF	GRM0335C1H4R7CA01#
			4.8pF	±0.05pF	GRM0335C1H4R8WA01#
				±0.1pF	GRM0335C1H4R8BA01#
				±0.25pF	GRM0335C1H4R8CA01#
			4.9pF	±0.05pF	GRM0335C1H4R9WA01#
				±0.1pF	GRM0335C1H4R9BA01#
				±0.25pF	GRM0335C1H4R9CA01#
			5.0pF	±0.05pF	GRM0335C1H5R0WA01#
				±0.1pF	GRM0335C1H5R0BA01#
				±0.25pF	GRM0335C1H5R0CA01#
			5.1pF	±0.05pF	GRM0335C1H5R1WA01#
				±0.1pF	GRM0335C1H5R1BA01#
				±0.25pF	GRM0335C1H5R1CA01#
				±0.5pF	GRM0335C1H5R1DA01#
			5.2pF	±0.05pF	GRM0335C1H5R2WA01#
				±0.1pF	GRM0335C1H5R2BA01#
				±0.25pF	GRM0335C1H5R2CA01#
				±0.5pF	GRM0335C1H5R2DA01#
			5.3pF	±0.05pF	GRM0335C1H5R3WA01#
				±0.1pF	GRM0335C1H5R3BA01#

T max.	Rated Voltage	TC Code	Cap.	Tol.	Part Number
0.33mm	50Vdc	COG	5.3pF	±0.25pF	GRM0335C1H5R3CA01#
				±0.5pF	GRM0335C1H5R3DA01#
			5.4pF	±0.05pF	GRM0335C1H5R4WA01#
				±0.1pF	GRM0335C1H5R4BA01#
				±0.25pF	GRM0335C1H5R4CA01#
			5.5pF	±0.05pF	GRM0335C1H5R5WA01#
				±0.1pF	GRM0335C1H5R5BA01#
				±0.25pF	GRM0335C1H5R5CA01#
			5.6pF	±0.05pF	GRM0335C1H5R6WA01#
				±0.1pF	GRM0335C1H5R6BA01#
				±0.25pF	GRM0335C1H5R6CA01#
			5.7pF	±0.05pF	GRM0335C1H5R7WA01#
				±0.1pF	GRM0335C1H5R7BA01#
				±0.25pF	GRM0335C1H5R7CA01#
			5.8pF	±0.05pF	GRM0335C1H5R8WA01#
				±0.1pF	GRM0335C1H5R8BA01#
				±0.25pF	GRM0335C1H5R8CA01#
			5.9pF	±0.05pF	GRM0335C1H5R9WA01#
				±0.1pF	GRM0335C1H5R9BA01#
				±0.25pF	GRM0335C1H5R9CA01#
			6.0pF	±0.05pF	GRM0335C1H6R0WA01#
				±0.1pF	GRM0335C1H6R0BA01#
				±0.25pF	GRM0335C1H6R0CA01#
			6.1pF	±0.05pF	GRM0335C1H6R1WA01#
				±0.1pF	GRM0335C1H6R1BA01#
				±0.25pF	GRM0335C1H6R1CA01#
			6.2pF	±0.05pF	GRM0335C1H6R2WA01#
				±0.1pF	GRM0335C1H6R2BA01#
				±0.25pF	GRM0335C1H6R2CA01#
			6.3pF	±0.05pF	GRM0335C1H6R3WA01#
				±0.1pF	GRM0335C1H6R3BA01#
				±0.25pF	GRM0335C1H6R3CA01#
			6.4pF	±0.05pF	GRM0335C1H6R4WA01#
				±0.1pF	GRM0335C1H6R4BA01#
				±0.25pF	GRM0335C1H6R4CA01#
			6.5pF	±0.05pF	GRM0335C1H6R5WA01#
				±0.1pF	GRM0335C1H6R5BA01#
				±0.25pF	GRM0335C1H6R5CA01#
			6.6pF	±0.05pF	GRM0335C1H6R6WA01#
				±0.1pF	GRM0335C1H6R6BA01#
				±0.25pF	GRM0335C1H6R6CA01#

Part number # indicates the package specification code.



GRM Series Temperature Compensating Type Part Number List

(→ 0.6×0.3mm)

T max.	Rated Voltage	TC Code	Cap.	Tol.	Part Number	T max.	Rated Voltage	TC Code	Cap.	Tol.	Part Number	
0.33mm	50Vdc	COG	6.7pF	±0.05pF	GRM0335C1H6R7WA01#	0.33mm	50Vdc	COG	8.0pF	±0.25pF	GRM0335C1H8ROCA01#	
				±0.1pF	GRM0335C1H6R7BA01#					±0.5pF	GRM0335C1H8RODA01#	
				±0.25pF	GRM0335C1H6R7CA01#					8.1pF	±0.05pF	GRM0335C1H8R1WA01#
				±0.5pF	GRM0335C1H6R7DA01#						±0.1pF	GRM0335C1H8R1BA01#
			6.8pF	±0.05pF	GRM0335C1H6R8WA01#				±0.25pF		GRM0335C1H8R1CA01#	
				±0.1pF	GRM0335C1H6R8BA01#				±0.5pF		GRM0335C1H8R1DA01#	
				±0.25pF	GRM0335C1H6R8CA01#				8.2pF	±0.05pF	GRM0335C1H8R2WA01#	
				±0.5pF	GRM0335C1H6R8DA01#					±0.1pF	GRM0335C1H8R2BA01#	
			6.9pF	±0.05pF	GRM0335C1H6R9WA01#					±0.25pF	GRM0335C1H8R2CA01#	
				±0.1pF	GRM0335C1H6R9BA01#					±0.5pF	GRM0335C1H8R2DA01#	
				±0.25pF	GRM0335C1H6R9CA01#				8.3pF	±0.05pF	GRM0335C1H8R3WA01#	
				±0.5pF	GRM0335C1H6R9DA01#					±0.1pF	GRM0335C1H8R3BA01#	
			7.0pF	±0.05pF	GRM0335C1H7R0WA01#					±0.25pF	GRM0335C1H8R3CA01#	
				±0.1pF	GRM0335C1H7R0BA01#					±0.5pF	GRM0335C1H8R3DA01#	
				±0.25pF	GRM0335C1H7R0CA01#				8.4pF	±0.05pF	GRM0335C1H8R4WA01#	
				±0.5pF	GRM0335C1H7R0DA01#					±0.1pF	GRM0335C1H8R4BA01#	
			7.1pF	±0.05pF	GRM0335C1H7R1WA01#					±0.25pF	GRM0335C1H8R4CA01#	
				±0.1pF	GRM0335C1H7R1BA01#					±0.5pF	GRM0335C1H8R4DA01#	
				±0.25pF	GRM0335C1H7R1CA01#				8.5pF	±0.05pF	GRM0335C1H8R5WA01#	
				±0.5pF	GRM0335C1H7R1DA01#					±0.1pF	GRM0335C1H8R5BA01#	
			7.2pF	±0.05pF	GRM0335C1H7R2WA01#					±0.25pF	GRM0335C1H8R5CA01#	
				±0.1pF	GRM0335C1H7R2BA01#					±0.5pF	GRM0335C1H8R5DA01#	
				±0.25pF	GRM0335C1H7R2CA01#				8.6pF	±0.05pF	GRM0335C1H8R6WA01#	
				±0.5pF	GRM0335C1H7R2DA01#					±0.1pF	GRM0335C1H8R6BA01#	
			7.3pF	±0.05pF	GRM0335C1H7R3WA01#					±0.25pF	GRM0335C1H8R6CA01#	
				±0.1pF	GRM0335C1H7R3BA01#					±0.5pF	GRM0335C1H8R6DA01#	
				±0.25pF	GRM0335C1H7R3CA01#				8.7pF	±0.05pF	GRM0335C1H8R7WA01#	
				±0.5pF	GRM0335C1H7R3DA01#					±0.1pF	GRM0335C1H8R7BA01#	
			7.4pF	±0.05pF	GRM0335C1H7R4WA01#					±0.25pF	GRM0335C1H8R7CA01#	
				±0.1pF	GRM0335C1H7R4BA01#					±0.5pF	GRM0335C1H8R7DA01#	
				±0.25pF	GRM0335C1H7R4CA01#				8.8pF	±0.05pF	GRM0335C1H8R8WA01#	
				±0.5pF	GRM0335C1H7R4DA01#					±0.1pF	GRM0335C1H8R8BA01#	
			7.5pF	±0.05pF	GRM0335C1H7R5WA01#					±0.25pF	GRM0335C1H8R8CA01#	
				±0.1pF	GRM0335C1H7R5BA01#					±0.5pF	GRM0335C1H8R8DA01#	
				±0.25pF	GRM0335C1H7R5CA01#				8.9pF	±0.05pF	GRM0335C1H8R9WA01#	
				±0.5pF	GRM0335C1H7R5DA01#					±0.1pF	GRM0335C1H8R9BA01#	
			7.6pF	±0.05pF	GRM0335C1H7R6WA01#					±0.25pF	GRM0335C1H8R9CA01#	
				±0.1pF	GRM0335C1H7R6BA01#					±0.5pF	GRM0335C1H8R9DA01#	
				±0.25pF	GRM0335C1H7R6CA01#				9.0pF	±0.05pF	GRM0335C1H9R0WA01#	
				±0.5pF	GRM0335C1H7R6DA01#					±0.1pF	GRM0335C1H9R0BA01#	
			7.7pF	±0.05pF	GRM0335C1H7R7WA01#					±0.25pF	GRM0335C1H9R0CA01#	
				±0.1pF	GRM0335C1H7R7BA01#					±0.5pF	GRM0335C1H9R0DA01#	
				±0.25pF	GRM0335C1H7R7CA01#				9.1pF	±0.05pF	GRM0335C1H9R1WA01#	
				±0.5pF	GRM0335C1H7R7DA01#					±0.1pF	GRM0335C1H9R1BA01#	
			7.8pF	±0.05pF	GRM0335C1H7R8WA01#					±0.25pF	GRM0335C1H9R1CA01#	
				±0.1pF	GRM0335C1H7R8BA01#					±0.5pF	GRM0335C1H9R1DA01#	
				±0.25pF	GRM0335C1H7R8CA01#				9.2pF	±0.05pF	GRM0335C1H9R2WA01#	
				±0.5pF	GRM0335C1H7R8DA01#					±0.1pF	GRM0335C1H9R2BA01#	
			7.9pF	±0.05pF	GRM0335C1H7R9WA01#					±0.25pF	GRM0335C1H9R2CA01#	
				±0.1pF	GRM0335C1H7R9BA01#					±0.5pF	GRM0335C1H9R2DA01#	
				±0.25pF	GRM0335C1H7R9CA01#				9.3pF	±0.05pF	GRM0335C1H9R3WA01#	
				±0.5pF	GRM0335C1H7R9DA01#					±0.1pF	GRM0335C1H9R3BA01#	
			8.0pF	±0.05pF	GRM0335C1H8R0WA01#					±0.25pF	GRM0335C1H9R3CA01#	
				±0.1pF	GRM0335C1H8R0BA01#					±0.5pF	GRM0335C1H9R3DA01#	

- GRM
- GR3
- GRJ
- GR4
- GR7
- GJM
- GQM
- GA2
- GA3 GB
- GA3 GD
- GA3 GF
- LLL
- LLA
- LLM
- LLR
- NFM
- KRM
- KR3
- GMA
- GMD
- ⚠Caution /Notice

Part number # indicates the package specification code.

GRM Series Temperature Compensating Type Part Number List

(→ 0.6×0.3mm)

T max.	Rated Voltage	TC Code	Cap.	Tol.	Part Number
0.33mm	50Vdc	COG	9.4pF	±0.05pF	GRM0335C1H9R4WA01#
				±0.1pF	GRM0335C1H9R4BA01#
				±0.25pF	GRM0335C1H9R4CA01#
				±0.5pF	GRM0335C1H9R4DA01#
			9.5pF	±0.05pF	GRM0335C1H9R5WA01#
				±0.1pF	GRM0335C1H9R5BA01#
				±0.25pF	GRM0335C1H9R5CA01#
				±0.5pF	GRM0335C1H9R5DA01#
			9.6pF	±0.05pF	GRM0335C1H9R6WA01#
				±0.1pF	GRM0335C1H9R6BA01#
				±0.25pF	GRM0335C1H9R6CA01#
				±0.5pF	GRM0335C1H9R6DA01#
			9.7pF	±0.05pF	GRM0335C1H9R7WA01#
				±0.1pF	GRM0335C1H9R7BA01#
				±0.25pF	GRM0335C1H9R7CA01#
				±0.5pF	GRM0335C1H9R7DA01#
			9.8pF	±0.05pF	GRM0335C1H9R8WA01#
				±0.1pF	GRM0335C1H9R8BA01#
				±0.25pF	GRM0335C1H9R8CA01#
				±0.5pF	GRM0335C1H9R8DA01#
			9.9pF	±0.05pF	GRM0335C1H9R9WA01#
				±0.1pF	GRM0335C1H9R9BA01#
				±0.25pF	GRM0335C1H9R9CA01#
				±0.5pF	GRM0335C1H9R9DA01#
			10pF	±2%	GRM0335C1H100GA01#
				±5%	GRM0335C1H100JA01#
			12pF	±2%	GRM0335C1H120GA01#
				±5%	GRM0335C1H120JA01#
			15pF	±2%	GRM0335C1H150GA01#
				±5%	GRM0335C1H150JA01#
			18pF	±2%	GRM0335C1H180GA01#
				±5%	GRM0335C1H180JA01#
			22pF	±2%	GRM0335C1H220GA01#
				±5%	GRM0335C1H220JA01#
			27pF	±2%	GRM0335C1H270GA01#
				±5%	GRM0335C1H270JA01#
			33pF	±2%	GRM0335C1H330GA01#
				±5%	GRM0335C1H330JA01#
			39pF	±2%	GRM0335C1H390GA01#
				±5%	GRM0335C1H390JA01#
			47pF	±2%	GRM0335C1H470GA01#
				±5%	GRM0335C1H470JA01#
			56pF	±2%	GRM0335C1H560GA01#
				±5%	GRM0335C1H560JA01#
			68pF	±2%	GRM0335C1H680GA01#
				±5%	GRM0335C1H680JA01#
			82pF	±2%	GRM0335C1H820GA01#
				±5%	GRM0335C1H820JA01#
			100pF	±2%	GRM0335C1H101GA01#
				±5%	GRM0335C1H101JA01#
			120pF	±2%	GRM0335C1H121GA01#
				±5%	GRM0335C1H121JA01#
			150pF	±2%	GRM0335C1H151GA01#
				±5%	GRM0335C1H151JA01#

T max.	Rated Voltage	TC Code	Cap.	Tol.	Part Number		
0.33mm	50Vdc	COG	180pF	±2%	GRM0335C1H181GA01#		
				±5%	GRM0335C1H181JA01#		
				220pF	±2%	GRM0335C1H221GA01#	
					±5%	GRM0335C1H221JA01#	
			CK	0.10pF	±0.05pF	GRM0334C1HR10WA01#	
					0.20pF	±0.05pF	GRM0334C1HR20WA01#
						±0.1pF	GRM0334C1HR20BA01#
					0.30pF	±0.05pF	GRM0334C1HR30WA01#
						±0.1pF	GRM0334C1HR30BA01#
					0.40pF	±0.05pF	GRM0334C1HR40WA01#
						±0.1pF	GRM0334C1HR40BA01#
					0.50pF	±0.05pF	GRM0334C1HR50WA01#
						±0.1pF	GRM0334C1HR50BA01#
					0.60pF	±0.05pF	GRM0334C1HR60WA01#
						±0.1pF	GRM0334C1HR60BA01#
					0.70pF	±0.05pF	GRM0334C1HR70WA01#
						±0.1pF	GRM0334C1HR70BA01#
					0.80pF	±0.05pF	GRM0334C1HR80WA01#
						±0.1pF	GRM0334C1HR80BA01#
					0.90pF	±0.05pF	GRM0334C1HR90WA01#
						±0.1pF	GRM0334C1HR90BA01#
					1.0pF	±0.05pF	GRM0334C1H1R0WA01#
						±0.1pF	GRM0334C1H1R0BA01#
						±0.25pF	GRM0334C1H1R0CA01#
					1.1pF	±0.05pF	GRM0334C1H1R1WA01#
						±0.1pF	GRM0334C1H1R1BA01#
						±0.25pF	GRM0334C1H1R1CA01#
					1.2pF	±0.05pF	GRM0334C1H1R2WA01#
						±0.1pF	GRM0334C1H1R2BA01#
						±0.25pF	GRM0334C1H1R2CA01#
					1.3pF	±0.05pF	GRM0334C1H1R3WA01#
						±0.1pF	GRM0334C1H1R3BA01#
						±0.25pF	GRM0334C1H1R3CA01#
					1.4pF	±0.05pF	GRM0334C1H1R4WA01#
						±0.1pF	GRM0334C1H1R4BA01#
						±0.25pF	GRM0334C1H1R4CA01#
					1.5pF	±0.05pF	GRM0334C1H1R5WA01#
						±0.1pF	GRM0334C1H1R5BA01#
						±0.25pF	GRM0334C1H1R5CA01#
					1.6pF	±0.05pF	GRM0334C1H1R6WA01#
±0.1pF	GRM0334C1H1R6BA01#						
±0.25pF	GRM0334C1H1R6CA01#						
1.7pF	±0.05pF	GRM0334C1H1R7WA01#					
	±0.1pF	GRM0334C1H1R7BA01#					
	±0.25pF	GRM0334C1H1R7CA01#					
1.8pF	±0.05pF	GRM0334C1H1R8WA01#					
	±0.1pF	GRM0334C1H1R8BA01#					
	±0.25pF	GRM0334C1H1R8CA01#					
1.9pF	±0.05pF	GRM0334C1H1R9WA01#					
	±0.1pF	GRM0334C1H1R9BA01#					
	±0.25pF	GRM0334C1H1R9CA01#					
2.0pF	±0.05pF	GRM0334C1H2R0WA01#					
	±0.1pF	GRM0334C1H2R0BA01#					
	±0.25pF	GRM0334C1H2R0CA01#					

Part number # indicates the package specification code.

GRM
 GR3
 GRJ
 GR4
 GR7
 GJM
 GQM
 GA2
 GA3 GB
 GA3 GD
 GA3 GF
 LLL
 LLA
 LLM
 LLR
 NFM
 KRM
 KR3
 GMA
 GMD
 ⚠Caution /Notice

GRM Series Temperature Compensating Type Part Number List

(→ 0.6×0.3mm)

T max.	Rated Voltage	TC Code	Cap.	Tol.	Part Number	T max.	Rated Voltage	TC Code	Cap.	Tol.	Part Number	
0.33mm	50Vdc	CJ	2.1pF	±0.05pF	GRM0333C1H2R1WA01#	0.33mm	50Vdc	CJ	3.9pF	±0.05pF	GRM0333C1H3R9WA01#	
				±0.1pF	GRM0333C1H2R1BA01#					±0.1pF	GRM0333C1H3R9BA01#	
				±0.25pF	GRM0333C1H2R1CA01#					±0.25pF	GRM0333C1H3R9CA01#	
			2.2pF	±0.05pF	GRM0333C1H2R2WA01#				CH	4.0pF	±0.05pF	GRM0332C1H4R0WA01#
				±0.1pF	GRM0333C1H2R2BA01#						±0.1pF	GRM0332C1H4R0BA01#
				±0.25pF	GRM0333C1H2R2CA01#						±0.25pF	GRM0332C1H4R0CA01#
			2.3pF	±0.05pF	GRM0333C1H2R3WA01#					4.1pF	±0.05pF	GRM0332C1H4R1WA01#
				±0.1pF	GRM0333C1H2R3BA01#						±0.1pF	GRM0332C1H4R1BA01#
				±0.25pF	GRM0333C1H2R3CA01#						±0.25pF	GRM0332C1H4R1CA01#
			2.4pF	±0.05pF	GRM0333C1H2R4WA01#					4.2pF	±0.05pF	GRM0332C1H4R2WA01#
				±0.1pF	GRM0333C1H2R4BA01#						±0.1pF	GRM0332C1H4R2BA01#
				±0.25pF	GRM0333C1H2R4CA01#						±0.25pF	GRM0332C1H4R2CA01#
			2.5pF	±0.05pF	GRM0333C1H2R5WA01#					4.3pF	±0.05pF	GRM0332C1H4R3WA01#
				±0.1pF	GRM0333C1H2R5BA01#						±0.1pF	GRM0332C1H4R3BA01#
				±0.25pF	GRM0333C1H2R5CA01#						±0.25pF	GRM0332C1H4R3CA01#
			2.6pF	±0.05pF	GRM0333C1H2R6WA01#					4.4pF	±0.05pF	GRM0332C1H4R4WA01#
				±0.1pF	GRM0333C1H2R6BA01#						±0.1pF	GRM0332C1H4R4BA01#
				±0.25pF	GRM0333C1H2R6CA01#						±0.25pF	GRM0332C1H4R4CA01#
			2.7pF	±0.05pF	GRM0333C1H2R7WA01#					4.5pF	±0.05pF	GRM0332C1H4R5WA01#
				±0.1pF	GRM0333C1H2R7BA01#						±0.1pF	GRM0332C1H4R5BA01#
				±0.25pF	GRM0333C1H2R7CA01#						±0.25pF	GRM0332C1H4R5CA01#
			2.8pF	±0.05pF	GRM0333C1H2R8WA01#					4.6pF	±0.05pF	GRM0332C1H4R6WA01#
				±0.1pF	GRM0333C1H2R8BA01#						±0.1pF	GRM0332C1H4R6BA01#
				±0.25pF	GRM0333C1H2R8CA01#						±0.25pF	GRM0332C1H4R6CA01#
			2.9pF	±0.05pF	GRM0333C1H2R9WA01#					4.7pF	±0.05pF	GRM0332C1H4R7WA01#
				±0.1pF	GRM0333C1H2R9BA01#						±0.1pF	GRM0332C1H4R7BA01#
				±0.25pF	GRM0333C1H2R9CA01#						±0.25pF	GRM0332C1H4R7CA01#
			3.0pF	±0.05pF	GRM0333C1H3R0WA01#					4.8pF	±0.05pF	GRM0332C1H4R8WA01#
				±0.1pF	GRM0333C1H3R0BA01#						±0.1pF	GRM0332C1H4R8BA01#
				±0.25pF	GRM0333C1H3R0CA01#						±0.25pF	GRM0332C1H4R8CA01#
			3.1pF	±0.05pF	GRM0333C1H3R1WA01#					4.9pF	±0.05pF	GRM0332C1H4R9WA01#
				±0.1pF	GRM0333C1H3R1BA01#						±0.1pF	GRM0332C1H4R9BA01#
				±0.25pF	GRM0333C1H3R1CA01#						±0.25pF	GRM0332C1H4R9CA01#
			3.2pF	±0.05pF	GRM0333C1H3R2WA01#					5.0pF	±0.05pF	GRM0332C1H5R0WA01#
				±0.1pF	GRM0333C1H3R2BA01#						±0.1pF	GRM0332C1H5R0BA01#
				±0.25pF	GRM0333C1H3R2CA01#						±0.25pF	GRM0332C1H5R0CA01#
			3.3pF	±0.05pF	GRM0333C1H3R3WA01#					5.1pF	±0.05pF	GRM0332C1H5R1WA01#
				±0.1pF	GRM0333C1H3R3BA01#						±0.1pF	GRM0332C1H5R1BA01#
				±0.25pF	GRM0333C1H3R3CA01#						±0.25pF	GRM0332C1H5R1CA01#
			3.4pF	±0.05pF	GRM0333C1H3R4WA01#					5.2pF	±0.05pF	GRM0332C1H5R2WA01#
				±0.1pF	GRM0333C1H3R4BA01#						±0.1pF	GRM0332C1H5R2BA01#
				±0.25pF	GRM0333C1H3R4CA01#						±0.25pF	GRM0332C1H5R2CA01#
			3.5pF	±0.05pF	GRM0333C1H3R5WA01#					5.3pF	±0.05pF	GRM0332C1H5R3WA01#
				±0.1pF	GRM0333C1H3R5BA01#						±0.1pF	GRM0332C1H5R3BA01#
				±0.25pF	GRM0333C1H3R5CA01#						±0.25pF	GRM0332C1H5R3CA01#
			3.6pF	±0.05pF	GRM0333C1H3R6WA01#					5.4pF	±0.05pF	GRM0332C1H5R4WA01#
				±0.1pF	GRM0333C1H3R6BA01#						±0.1pF	GRM0332C1H5R4BA01#
				±0.25pF	GRM0333C1H3R6CA01#						±0.25pF	GRM0332C1H5R4CA01#
			3.7pF	±0.05pF	GRM0333C1H3R7WA01#					5.5pF	±0.05pF	GRM0332C1H5R5WA01#
				±0.1pF	GRM0333C1H3R7BA01#						±0.1pF	GRM0332C1H5R5BA01#
				±0.25pF	GRM0333C1H3R7CA01#						±0.25pF	GRM0332C1H5R5CA01#
			3.8pF	±0.05pF	GRM0333C1H3R8WA01#						±0.05pF	GRM0332C1H5R5WA01#
				±0.1pF	GRM0333C1H3R8BA01#						±0.1pF	GRM0332C1H5R5BA01#
				±0.25pF	GRM0333C1H3R8CA01#						±0.25pF	GRM0332C1H5R5CA01#

Part number # indicates the package specification code.

GRM
 GR3
 GRJ
 GR4
 GR7
 GJM
 GQM
 GA2
 GA3 GB
 GA3 GD
 GA3 GF
 LLL
 LLA
 LLM
 LLR
 NFM
 KRM
 KR3
 GMA
 GMD
 ⚠Caution /Notice

GRM Series Temperature Compensating Type Part Number List

(→ 0.6×0.3mm)

T max.	Rated Voltage	TC Code	Cap.	Tol.	Part Number	T max.	Rated Voltage	TC Code	Cap.	Tol.	Part Number
0.33mm	50Vdc	CH	5.5pF	±0.25pF	GRM0332C1H5R5CA01#	0.33mm	50Vdc	CH	6.9pF	±0.05pF	GRM0332C1H6R9WA01#
				±0.5pF	GRM0332C1H5R5DA01#					±0.1pF	GRM0332C1H6R9BA01#
			5.6pF	±0.05pF	GRM0332C1H5R6WA01#				±0.25pF	GRM0332C1H6R9CA01#	
				±0.1pF	GRM0332C1H5R6BA01#				±0.5pF	GRM0332C1H6R9DA01#	
				±0.25pF	GRM0332C1H5R6CA01#				7.0pF	±0.05pF	GRM0332C1H7R0WA01#
				±0.5pF	GRM0332C1H5R6DA01#					±0.1pF	GRM0332C1H7R0BA01#
			5.7pF	±0.05pF	GRM0332C1H5R7WA01#					±0.25pF	GRM0332C1H7R0CA01#
				±0.1pF	GRM0332C1H5R7BA01#				±0.5pF	GRM0332C1H7R0DA01#	
				±0.25pF	GRM0332C1H5R7CA01#				7.1pF	±0.05pF	GRM0332C1H7R1WA01#
			±0.5pF	GRM0332C1H5R7DA01#	±0.1pF					GRM0332C1H7R1BA01#	
			5.8pF	±0.05pF	GRM0332C1H5R8WA01#					±0.25pF	GRM0332C1H7R1CA01#
				±0.1pF	GRM0332C1H5R8BA01#				±0.5pF	GRM0332C1H7R1DA01#	
				±0.25pF	GRM0332C1H5R8CA01#				7.2pF	±0.05pF	GRM0332C1H7R2WA01#
				±0.5pF	GRM0332C1H5R8DA01#					±0.1pF	GRM0332C1H7R2BA01#
			5.9pF	±0.05pF	GRM0332C1H5R9WA01#					±0.25pF	GRM0332C1H7R2CA01#
				±0.1pF	GRM0332C1H5R9BA01#				±0.5pF	GRM0332C1H7R2DA01#	
				±0.25pF	GRM0332C1H5R9CA01#				7.3pF	±0.05pF	GRM0332C1H7R3WA01#
				±0.5pF	GRM0332C1H5R9DA01#					±0.1pF	GRM0332C1H7R3BA01#
			6.0pF	±0.05pF	GRM0332C1H6R0WA01#					±0.25pF	GRM0332C1H7R3CA01#
				±0.1pF	GRM0332C1H6R0BA01#				±0.5pF	GRM0332C1H7R3DA01#	
				±0.25pF	GRM0332C1H6R0CA01#				7.4pF	±0.05pF	GRM0332C1H7R4WA01#
				±0.5pF	GRM0332C1H6R0DA01#					±0.1pF	GRM0332C1H7R4BA01#
			6.1pF	±0.05pF	GRM0332C1H6R1WA01#					±0.25pF	GRM0332C1H7R4CA01#
				±0.1pF	GRM0332C1H6R1BA01#				±0.5pF	GRM0332C1H7R4DA01#	
				±0.25pF	GRM0332C1H6R1CA01#				7.5pF	±0.05pF	GRM0332C1H7R5WA01#
				±0.5pF	GRM0332C1H6R1DA01#					±0.1pF	GRM0332C1H7R5BA01#
			6.2pF	±0.05pF	GRM0332C1H6R2WA01#					±0.25pF	GRM0332C1H7R5CA01#
				±0.1pF	GRM0332C1H6R2BA01#				±0.5pF	GRM0332C1H7R5DA01#	
				±0.25pF	GRM0332C1H6R2CA01#				7.6pF	±0.05pF	GRM0332C1H7R6WA01#
				±0.5pF	GRM0332C1H6R2DA01#					±0.1pF	GRM0332C1H7R6BA01#
			6.3pF	±0.05pF	GRM0332C1H6R3WA01#					±0.25pF	GRM0332C1H7R6CA01#
				±0.1pF	GRM0332C1H6R3BA01#				±0.5pF	GRM0332C1H7R6DA01#	
				±0.25pF	GRM0332C1H6R3CA01#				7.7pF	±0.05pF	GRM0332C1H7R7WA01#
				±0.5pF	GRM0332C1H6R3DA01#					±0.1pF	GRM0332C1H7R7BA01#
			6.4pF	±0.05pF	GRM0332C1H6R4WA01#					±0.25pF	GRM0332C1H7R7CA01#
				±0.1pF	GRM0332C1H6R4BA01#				±0.5pF	GRM0332C1H7R7DA01#	
				±0.25pF	GRM0332C1H6R4CA01#				7.8pF	±0.05pF	GRM0332C1H7R8WA01#
				±0.5pF	GRM0332C1H6R4DA01#					±0.1pF	GRM0332C1H7R8BA01#
			6.5pF	±0.05pF	GRM0332C1H6R5WA01#					±0.25pF	GRM0332C1H7R8CA01#
				±0.1pF	GRM0332C1H6R5BA01#				±0.5pF	GRM0332C1H7R8DA01#	
				±0.25pF	GRM0332C1H6R5CA01#				7.9pF	±0.05pF	GRM0332C1H7R9WA01#
				±0.5pF	GRM0332C1H6R5DA01#					±0.1pF	GRM0332C1H7R9BA01#
			6.6pF	±0.05pF	GRM0332C1H6R6WA01#					±0.25pF	GRM0332C1H7R9CA01#
				±0.1pF	GRM0332C1H6R6BA01#				±0.5pF	GRM0332C1H7R9DA01#	
				±0.25pF	GRM0332C1H6R6CA01#				8.0pF	±0.05pF	GRM0332C1H8R0WA01#
				±0.5pF	GRM0332C1H6R6DA01#					±0.1pF	GRM0332C1H8R0BA01#
			6.7pF	±0.05pF	GRM0332C1H6R7WA01#					±0.25pF	GRM0332C1H8R0CA01#
				±0.1pF	GRM0332C1H6R7BA01#				±0.5pF	GRM0332C1H8R0DA01#	
				±0.25pF	GRM0332C1H6R7CA01#				8.1pF	±0.05pF	GRM0332C1H8R1WA01#
				±0.5pF	GRM0332C1H6R7DA01#					±0.1pF	GRM0332C1H8R1BA01#
			6.8pF	±0.05pF	GRM0332C1H6R8WA01#					±0.25pF	GRM0332C1H8R1CA01#
				±0.1pF	GRM0332C1H6R8BA01#				±0.5pF	GRM0332C1H8R1DA01#	
				±0.25pF	GRM0332C1H6R8CA01#				8.2pF	±0.05pF	GRM0332C1H8R2WA01#
				±0.5pF	GRM0332C1H6R8DA01#					±0.1pF	GRM0332C1H8R2BA01#

Part number # indicates the package specification code.



GRM Series Temperature Compensating Type Part Number List

(→ 0.6×0.3mm)

T max.	Rated Voltage	TC Code	Cap.	Tol.	Part Number	T max.	Rated Voltage	TC Code	Cap.	Tol.	Part Number	
0.33mm	50Vdc	CH	8.2pF	±0.25pF	GRM0332C1H8R2CA01#	0.33mm	50Vdc	CH	9.6pF	±0.05pF	GRM0332C1H9R6WA01#	
				±0.5pF	GRM0332C1H8R2DA01#					±0.1pF	GRM0332C1H9R6BA01#	
			8.3pF	±0.05pF	GRM0332C1H8R3WA01#	9.7pF			±0.25pF	GRM0332C1H9R6CA01#		
				±0.1pF	GRM0332C1H8R3BA01#				±0.5pF	GRM0332C1H9R6DA01#		
				±0.25pF	GRM0332C1H8R3CA01#				9.8pF	±0.05pF	GRM0332C1H9R7WA01#	
				±0.5pF	GRM0332C1H8R3DA01#					±0.1pF	GRM0332C1H9R7BA01#	
			8.4pF	±0.05pF	GRM0332C1H8R4WA01#	±0.25pF				GRM0332C1H9R7CA01#		
				±0.1pF	GRM0332C1H8R4BA01#	±0.5pF			GRM0332C1H9R7DA01#			
				±0.25pF	GRM0332C1H8R4CA01#	9.9pF			±0.05pF	GRM0332C1H9R8WA01#		
			±0.5pF	GRM0332C1H8R4DA01#	±0.1pF				GRM0332C1H9R8BA01#			
			8.5pF	±0.05pF	GRM0332C1H8R5WA01#				±0.25pF	GRM0332C1H9R8CA01#		
				±0.1pF	GRM0332C1H8R5BA01#	±0.5pF			GRM0332C1H9R8DA01#			
				±0.25pF	GRM0332C1H8R5CA01#	10pF			±0.05pF	GRM0332C1H9R9WA01#		
			±0.5pF	GRM0332C1H8R5DA01#	±0.1pF				GRM0332C1H9R9BA01#			
			8.6pF	±0.05pF	GRM0332C1H8R6WA01#				±0.25pF	GRM0332C1H9R9CA01#		
				±0.1pF	GRM0332C1H8R6BA01#	±0.5pF			GRM0332C1H9R9DA01#			
				±0.25pF	GRM0332C1H8R6CA01#	12pF			±2%	GRM0332C1H100GA01#		
				±0.5pF	GRM0332C1H8R6DA01#				±5%	GRM0332C1H100JA01#		
			8.7pF	±0.05pF	GRM0332C1H8R7WA01#	15pF			±2%	GRM0332C1H150GA01#		
				±0.1pF	GRM0332C1H8R7BA01#				±5%	GRM0332C1H150JA01#		
				±0.25pF	GRM0332C1H8R7CA01#	18pF			±2%	GRM0332C1H180GA01#		
				±0.5pF	GRM0332C1H8R7DA01#				±5%	GRM0332C1H180JA01#		
			8.8pF	±0.05pF	GRM0332C1H8R8WA01#	22pF			±2%	GRM0332C1H220GA01#		
				±0.1pF	GRM0332C1H8R8BA01#				±5%	GRM0332C1H220JA01#		
				±0.25pF	GRM0332C1H8R8CA01#	27pF			±2%	GRM0332C1H270GA01#		
				±0.5pF	GRM0332C1H8R8DA01#				±5%	GRM0332C1H270JA01#		
			8.9pF	±0.05pF	GRM0332C1H8R9WA01#	33pF			±2%	GRM0332C1H330GA01#		
				±0.1pF	GRM0332C1H8R9BA01#				±5%	GRM0332C1H330JA01#		
				±0.25pF	GRM0332C1H8R9CA01#	39pF			±2%	GRM0332C1H390GA01#		
				±0.5pF	GRM0332C1H8R9DA01#				±5%	GRM0332C1H390JA01#		
			9.0pF	±0.05pF	GRM0332C1H9R0WA01#	47pF			±2%	GRM0332C1H470GA01#		
				±0.1pF	GRM0332C1H9R0BA01#				±5%	GRM0332C1H470JA01#		
				±0.25pF	GRM0332C1H9R0CA01#	56pF			±2%	GRM0332C1H560GA01#		
				±0.5pF	GRM0332C1H9R0DA01#				±5%	GRM0332C1H560JA01#		
			9.1pF	±0.05pF	GRM0332C1H9R1WA01#	68pF			±2%	GRM0332C1H680GA01#		
				±0.1pF	GRM0332C1H9R1BA01#				±5%	GRM0332C1H680JA01#		
				±0.25pF	GRM0332C1H9R1CA01#	82pF			±2%	GRM0332C1H820GA01#		
				±0.5pF	GRM0332C1H9R1DA01#				±5%	GRM0332C1H820JA01#		
			9.2pF	±0.05pF	GRM0332C1H9R2WA01#	100pF			±2%	GRM0332C1H101GA01#		
				±0.1pF	GRM0332C1H9R2BA01#				±5%	GRM0332C1H101JA01#		
				±0.25pF	GRM0332C1H9R2CA01#	120pF			±2%	GRM0332C1H121GA01#		
				±0.5pF	GRM0332C1H9R2DA01#				±5%	GRM0332C1H121JA01#		
			9.3pF	±0.05pF	GRM0332C1H9R3WA01#	150pF			±2%	GRM0332C1H151GA01#		
				±0.1pF	GRM0332C1H9R3BA01#				±5%	GRM0332C1H151JA01#		
				±0.25pF	GRM0332C1H9R3CA01#	180pF			±2%	GRM0332C1H181GA01#		
				±0.5pF	GRM0332C1H9R3DA01#				±5%	GRM0332C1H181JA01#		
			9.4pF	±0.05pF	GRM0332C1H9R4WA01#	220pF			±2%	GRM0332C1H221GA01#		
				±0.1pF	GRM0332C1H9R4BA01#				±5%	GRM0332C1H221JA01#		
				±0.25pF	GRM0332C1H9R4CA01#	270pF			±2%	GRM0335C1E271GA01#		
				±0.5pF	GRM0332C1H9R4DA01#				±5%	GRM0335C1E271JA01#		
			9.5pF	±0.05pF	GRM0332C1H9R5WA01#	25Vdc			COG	330pF	±2%	GRM0335C1E331GA01#
				±0.1pF	GRM0332C1H9R5BA01#						±5%	GRM0335C1E331JA01#
				±0.25pF	GRM0332C1H9R5CA01#						±2%	GRM0335C1E331GA01#
				±0.5pF	GRM0332C1H9R5DA01#						±5%	GRM0335C1E331JA01#

Part number # indicates the package specification code.

GRM
 GR3
 GRJ
 GR4
 GR7
 GJM
 GQM
 GA2
 GA3 GB
 GA3 GD
 GA3 GF
 LLL
 LLA
 LLM
 LLR
 NFM
 KRM
 KR3
 GMA
 GMD
 ⚠Caution /Notice

GRM Series Temperature Compensating Type Part Number List

(→ 0.6×0.3mm)

T max.	Rated Voltage	TC Code	Cap.	Tol.	Part Number	
0.33mm	25Vdc	COG	390pF	±2%	GRM0335C1E391GA01#	
				±5%	GRM0335C1E391JA01#	
			470pF	±2%	GRM0335C1E471GA01#	
				±5%	GRM0335C1E471JA01#	
			560pF	±2%	GRM0335C1E561GA01#	
				±5%	GRM0335C1E561JA01#	
			680pF	±2%	GRM0335C1E681GA01#	
				±5%	GRM0335C1E681JA01#	
			820pF	±2%	GRM0335C1E821GA01#	
				±5%	GRM0335C1E821JA01#	
			910pF	±2%	GRM0335C1E911GA01#	
				±5%	GRM0335C1E911JA01#	
			1000pF	±2%	GRM0335C1E102GA01#	
				±5%	GRM0335C1E102JA01#	
			CH	270pF	±2%	GRM0332C1E271GA01#
					±5%	GRM0332C1E271JA01#
				330pF	±2%	GRM0332C1E331GA01#
					±5%	GRM0332C1E331JA01#
				390pF	±2%	GRM0332C1E391GA01#
					±5%	GRM0332C1E391JA01#
				470pF	±2%	GRM0332C1E471GA01#
		±5%			GRM0332C1E471JA01#	
		560pF		±2%	GRM0332C1E561GA01#	
				±5%	GRM0332C1E561JA01#	
		680pF		±2%	GRM0332C1E681GA01#	
				±5%	GRM0332C1E681JA01#	
		820pF		±2%	GRM0332C1E821GA01#	
				±5%	GRM0332C1E821JA01#	
		1000pF		±2%	GRM0332C1E102GA01#	
				±5%	GRM0332C1E102JA01#	

T max.	Rated Voltage	TC Code	Cap.	Tol.	Part Number
0.55mm	100Vdc	COG	1.0pF	±0.25pF	GRM1555C2A1ROCA01#
			1.1pF	±0.05pF	GRM1555C2A1R1WA01#
				±0.1pF	GRM1555C2A1R1BA01#
				±0.25pF	GRM1555C2A1R1CA01#
			1.2pF	±0.05pF	GRM1555C2A1R2WA01#
				±0.1pF	GRM1555C2A1R2BA01#
				±0.25pF	GRM1555C2A1R2CA01#
			1.3pF	±0.05pF	GRM1555C2A1R3WA01#
				±0.1pF	GRM1555C2A1R3BA01#
				±0.25pF	GRM1555C2A1R3CA01#
			1.4pF	±0.05pF	GRM1555C2A1R4WA01#
				±0.1pF	GRM1555C2A1R4BA01#
				±0.25pF	GRM1555C2A1R4CA01#
			1.5pF	±0.05pF	GRM1555C2A1R5WA01#
				±0.1pF	GRM1555C2A1R5BA01#
				±0.25pF	GRM1555C2A1R5CA01#
			1.6pF	±0.05pF	GRM1555C2A1R6WA01#
				±0.1pF	GRM1555C2A1R6BA01#
				±0.25pF	GRM1555C2A1R6CA01#
			1.7pF	±0.05pF	GRM1555C2A1R7WA01#
				±0.1pF	GRM1555C2A1R7BA01#
				±0.25pF	GRM1555C2A1R7CA01#
			1.8pF	±0.05pF	GRM1555C2A1R8WA01#
				±0.1pF	GRM1555C2A1R8BA01#
				±0.25pF	GRM1555C2A1R8CA01#
			1.9pF	±0.05pF	GRM1555C2A1R9WA01#
				±0.1pF	GRM1555C2A1R9BA01#
				±0.25pF	GRM1555C2A1R9CA01#
			2.0pF	±0.05pF	GRM1555C2A2R0WA01#
				±0.1pF	GRM1555C2A2R0BA01#
				±0.25pF	GRM1555C2A2R0CA01#
			2.1pF	±0.05pF	GRM1555C2A2R1WA01#
				±0.1pF	GRM1555C2A2R1BA01#
				±0.25pF	GRM1555C2A2R1CA01#
			2.2pF	±0.05pF	GRM1555C2A2R2WA01#
				±0.1pF	GRM1555C2A2R2BA01#
				±0.25pF	GRM1555C2A2R2CA01#
			2.3pF	±0.05pF	GRM1555C2A2R3WA01#
				±0.1pF	GRM1555C2A2R3BA01#
				±0.25pF	GRM1555C2A2R3CA01#
			2.4pF	±0.05pF	GRM1555C2A2R4WA01#
				±0.1pF	GRM1555C2A2R4BA01#
				±0.25pF	GRM1555C2A2R4CA01#
			2.5pF	±0.05pF	GRM1555C2A2R5WA01#
				±0.1pF	GRM1555C2A2R5BA01#
				±0.25pF	GRM1555C2A2R5CA01#
			2.6pF	±0.05pF	GRM1555C2A2R6WA01#
				±0.1pF	GRM1555C2A2R6BA01#
				±0.25pF	GRM1555C2A2R6CA01#
			2.7pF	±0.05pF	GRM1555C2A2R7WA01#
				±0.1pF	GRM1555C2A2R7BA01#
				±0.25pF	GRM1555C2A2R7CA01#
			2.8pF	±0.05pF	GRM1555C2A2R8WA01#
				±0.1pF	GRM1555C2A2R8BA01#

1.0×0.5mm

T max.	Rated Voltage	TC Code	Cap.	Tol.	Part Number
0.55mm	100Vdc	COG	0.10pF	±0.05pF	GRM1555C2AR10WA01#
				±0.1pF	GRM1555C2AR10BA01#
			0.20pF	±0.05pF	GRM1555C2AR20WA01#
				±0.1pF	GRM1555C2AR20BA01#
			0.30pF	±0.05pF	GRM1555C2AR30WA01#
				±0.1pF	GRM1555C2AR30BA01#
			0.40pF	±0.05pF	GRM1555C2AR40WA01#
				±0.1pF	GRM1555C2AR40BA01#
			0.50pF	±0.05pF	GRM1555C2AR50WA01#
				±0.1pF	GRM1555C2AR50BA01#
			0.60pF	±0.05pF	GRM1555C2AR60WA01#
				±0.1pF	GRM1555C2AR60BA01#
			0.70pF	±0.05pF	GRM1555C2AR70WA01#
				±0.1pF	GRM1555C2AR70BA01#
			0.80pF	±0.05pF	GRM1555C2AR80WA01#
				±0.1pF	GRM1555C2AR80BA01#
			0.90pF	±0.05pF	GRM1555C2AR90WA01#
				±0.1pF	GRM1555C2AR90BA01#
			1.0pF	±0.05pF	GRM1555C2A1R0WA01#
				±0.1pF	GRM1555C2A1R0BA01#

Part number # indicates the package specification code.

GRM
 GR3
 GRJ
 GR4
 GR7
 GJM
 GQM
 GA2
 GA3 GB
 GA3 GD
 GA3 GF
 LLL
 LLA
 LLM
 LLR
 NFM
 KRM
 KR3
 GMA
 GMD
 ⚠Caution /Notice

GRM Series Temperature Compensating Type Part Number List

(→ 1.0×0.5mm)

T max.	Rated Voltage	TC Code	Cap.	Tol.	Part Number	T max.	Rated Voltage	TC Code	Cap.	Tol.	Part Number	
0.55mm	100Vdc	COG	2.8pF	±0.25pF	GRM1555C2A2R8CA01#	0.55mm	100Vdc	COG	4.6pF	±0.25pF	GRM1555C2A4R6CA01#	
				±0.05pF	GRM1555C2A2R9WA01#					4.7pF	±0.05pF	GRM1555C2A4R7WA01#
					±0.1pF						GRM1555C2A2R9BA01#	±0.1pF
			±0.25pF		GRM1555C2A2R9CA01#				±0.25pF		GRM1555C2A4R7CA01#	
			3.0pF	±0.05pF	GRM1555C2A3R0WA01#				4.8pF	±0.05pF	GRM1555C2A4R8WA01#	
				±0.1pF	GRM1555C2A3R0BA01#					±0.1pF	GRM1555C2A4R8BA01#	
				±0.25pF	GRM1555C2A3R0CA01#					±0.25pF	GRM1555C2A4R8CA01#	
			3.1pF	±0.05pF	GRM1555C2A3R1WA01#				4.9pF	±0.05pF	GRM1555C2A4R9WA01#	
				±0.1pF	GRM1555C2A3R1BA01#					±0.1pF	GRM1555C2A4R9BA01#	
				±0.25pF	GRM1555C2A3R1CA01#					±0.25pF	GRM1555C2A4R9CA01#	
			3.2pF	±0.05pF	GRM1555C2A3R2WA01#				5.0pF	±0.05pF	GRM1555C2A5R0WA01#	
				±0.1pF	GRM1555C2A3R2BA01#					±0.1pF	GRM1555C2A5R0BA01#	
				±0.25pF	GRM1555C2A3R2CA01#					±0.25pF	GRM1555C2A5R0CA01#	
			3.3pF	±0.05pF	GRM1555C2A3R3WA01#				5.1pF	±0.05pF	GRM1555C2A5R1WA01#	
				±0.1pF	GRM1555C2A3R3BA01#					±0.1pF	GRM1555C2A5R1BA01#	
				±0.25pF	GRM1555C2A3R3CA01#					±0.25pF	GRM1555C2A5R1CA01#	
			3.4pF	±0.05pF	GRM1555C2A3R4WA01#				5.2pF	±0.05pF	GRM1555C2A5R2WA01#	
				±0.1pF	GRM1555C2A3R4BA01#					±0.1pF	GRM1555C2A5R2BA01#	
				±0.25pF	GRM1555C2A3R4CA01#					±0.25pF	GRM1555C2A5R2CA01#	
			3.5pF	±0.05pF	GRM1555C2A3R5WA01#				5.3pF	±0.05pF	GRM1555C2A5R3WA01#	
				±0.1pF	GRM1555C2A3R5BA01#					±0.1pF	GRM1555C2A5R3BA01#	
				±0.25pF	GRM1555C2A3R5CA01#					±0.25pF	GRM1555C2A5R3CA01#	
			3.6pF	±0.05pF	GRM1555C2A3R6WA01#				5.4pF	±0.05pF	GRM1555C2A5R4WA01#	
				±0.1pF	GRM1555C2A3R6BA01#					±0.1pF	GRM1555C2A5R4BA01#	
				±0.25pF	GRM1555C2A3R6CA01#					±0.25pF	GRM1555C2A5R4CA01#	
			3.7pF	±0.05pF	GRM1555C2A3R7WA01#				5.5pF	±0.05pF	GRM1555C2A5R5WA01#	
				±0.1pF	GRM1555C2A3R7BA01#					±0.1pF	GRM1555C2A5R5BA01#	
				±0.25pF	GRM1555C2A3R7CA01#					±0.25pF	GRM1555C2A5R5CA01#	
			3.8pF	±0.05pF	GRM1555C2A3R8WA01#				5.6pF	±0.05pF	GRM1555C2A5R6WA01#	
				±0.1pF	GRM1555C2A3R8BA01#					±0.1pF	GRM1555C2A5R6BA01#	
				±0.25pF	GRM1555C2A3R8CA01#					±0.25pF	GRM1555C2A5R6CA01#	
			3.9pF	±0.05pF	GRM1555C2A3R9WA01#				5.7pF	±0.05pF	GRM1555C2A5R7WA01#	
				±0.1pF	GRM1555C2A3R9BA01#					±0.1pF	GRM1555C2A5R7BA01#	
				±0.25pF	GRM1555C2A3R9CA01#					±0.25pF	GRM1555C2A5R7CA01#	
			4.0pF	±0.05pF	GRM1555C2A4R0WA01#				5.8pF	±0.05pF	GRM1555C2A5R8WA01#	
				±0.1pF	GRM1555C2A4R0BA01#					±0.1pF	GRM1555C2A5R8BA01#	
				±0.25pF	GRM1555C2A4R0CA01#					±0.25pF	GRM1555C2A5R8CA01#	
			4.1pF	±0.05pF	GRM1555C2A4R1WA01#				5.9pF	±0.05pF	GRM1555C2A5R9WA01#	
				±0.1pF	GRM1555C2A4R1BA01#					±0.1pF	GRM1555C2A5R9BA01#	
				±0.25pF	GRM1555C2A4R1CA01#					±0.25pF	GRM1555C2A5R9CA01#	
			4.2pF	±0.05pF	GRM1555C2A4R2WA01#				6.0pF	±0.05pF	GRM1555C2A6R0WA01#	
				±0.1pF	GRM1555C2A4R2BA01#					±0.1pF	GRM1555C2A6R0BA01#	
				±0.25pF	GRM1555C2A4R2CA01#					±0.25pF	GRM1555C2A6R0CA01#	
			4.3pF	±0.05pF	GRM1555C2A4R3WA01#				6.1pF	±0.05pF	GRM1555C2A6R1WA01#	
				±0.1pF	GRM1555C2A4R3BA01#					±0.1pF	GRM1555C2A6R1BA01#	
				±0.25pF	GRM1555C2A4R3CA01#					±0.25pF	GRM1555C2A6R1CA01#	
			4.4pF	±0.05pF	GRM1555C2A4R4WA01#							
				±0.1pF	GRM1555C2A4R4BA01#							
				±0.25pF	GRM1555C2A4R4CA01#							
			4.5pF	±0.05pF	GRM1555C2A4R5WA01#							
				±0.1pF	GRM1555C2A4R5BA01#							
				±0.25pF	GRM1555C2A4R5CA01#							
			4.6pF	±0.05pF	GRM1555C2A4R6WA01#							
				±0.1pF	GRM1555C2A4R6BA01#							

Part number # indicates the package specification code.

GRM
 GR3
 GRJ
 GR4
 GR7
 GJM
 GQM
 GA2
 GA3 GB
 GA3 GD
 GA3 GF
 LLL
 LLA
 LLM
 LLR
 NFM
 KRM
 KR3
 GMA
 GMD
 ⚠Caution /Notice

GRM Series Temperature Compensating Type Part Number List

(→ 1.0×0.5mm)

T max.	Rated Voltage	TC Code	Cap.	Tol.	Part Number	T max.	Rated Voltage	TC Code	Cap.	Tol.	Part Number
0.55mm	100Vdc	COG	6.1pF	±0.1pF	GRM1555C2A6R1BA01#	0.55mm	100Vdc	COG	7.4pF	±0.5pF	GRM1555C2A7R4DA01#
				±0.25pF	GRM1555C2A6R1CA01#					±0.05pF	GRM1555C2A7R5WA01#
				±0.5pF	GRM1555C2A6R1DA01#					±0.1pF	GRM1555C2A7R5BA01#
			6.2pF	±0.05pF	GRM1555C2A6R2WA01#				±0.25pF	GRM1555C2A7R5CA01#	
				±0.1pF	GRM1555C2A6R2BA01#				±0.5pF	GRM1555C2A7R5DA01#	
				±0.25pF	GRM1555C2A6R2CA01#				7.6pF	±0.05pF	GRM1555C2A7R6WA01#
			±0.5pF	GRM1555C2A6R2DA01#	±0.1pF					GRM1555C2A7R6BA01#	
			6.3pF	±0.05pF	GRM1555C2A6R3WA01#					±0.25pF	GRM1555C2A7R6CA01#
				±0.1pF	GRM1555C2A6R3BA01#				±0.5pF	GRM1555C2A7R6DA01#	
				±0.25pF	GRM1555C2A6R3CA01#				7.7pF	±0.05pF	GRM1555C2A7R7WA01#
			±0.5pF	GRM1555C2A6R3DA01#	±0.1pF					GRM1555C2A7R7BA01#	
			6.4pF	±0.05pF	GRM1555C2A6R4WA01#					±0.25pF	GRM1555C2A7R7CA01#
				±0.1pF	GRM1555C2A6R4BA01#				±0.5pF	GRM1555C2A7R7DA01#	
				±0.25pF	GRM1555C2A6R4CA01#				7.8pF	±0.05pF	GRM1555C2A7R8WA01#
			±0.5pF	GRM1555C2A6R4DA01#	±0.1pF					GRM1555C2A7R8BA01#	
			6.5pF	±0.05pF	GRM1555C2A6R5WA01#					±0.25pF	GRM1555C2A7R8CA01#
				±0.1pF	GRM1555C2A6R5BA01#				±0.5pF	GRM1555C2A7R8DA01#	
				±0.25pF	GRM1555C2A6R5CA01#				7.9pF	±0.05pF	GRM1555C2A7R9WA01#
			±0.5pF	GRM1555C2A6R5DA01#	±0.1pF					GRM1555C2A7R9BA01#	
			6.6pF	±0.05pF	GRM1555C2A6R6WA01#					±0.25pF	GRM1555C2A7R9CA01#
				±0.1pF	GRM1555C2A6R6BA01#				±0.5pF	GRM1555C2A7R9DA01#	
				±0.25pF	GRM1555C2A6R6CA01#				8.0pF	±0.05pF	GRM1555C2A8R0WA01#
			±0.5pF	GRM1555C2A6R6DA01#	±0.1pF					GRM1555C2A8R0BA01#	
			6.7pF	±0.05pF	GRM1555C2A6R7WA01#					±0.25pF	GRM1555C2A8R0CA01#
				±0.1pF	GRM1555C2A6R7BA01#				±0.5pF	GRM1555C2A8R0DA01#	
				±0.25pF	GRM1555C2A6R7CA01#				8.1pF	±0.05pF	GRM1555C2A8R1WA01#
			±0.5pF	GRM1555C2A6R7DA01#	±0.1pF					GRM1555C2A8R1BA01#	
			6.8pF	±0.05pF	GRM1555C2A6R8WA01#					±0.25pF	GRM1555C2A8R1CA01#
				±0.1pF	GRM1555C2A6R8BA01#				±0.5pF	GRM1555C2A8R1DA01#	
				±0.25pF	GRM1555C2A6R8CA01#				8.2pF	±0.05pF	GRM1555C2A8R2WA01#
			±0.5pF	GRM1555C2A6R8DA01#	±0.1pF					GRM1555C2A8R2BA01#	
			6.9pF	±0.05pF	GRM1555C2A6R9WA01#					±0.25pF	GRM1555C2A8R2CA01#
				±0.1pF	GRM1555C2A6R9BA01#				±0.5pF	GRM1555C2A8R2DA01#	
				±0.25pF	GRM1555C2A6R9CA01#				8.3pF	±0.05pF	GRM1555C2A8R3WA01#
			±0.5pF	GRM1555C2A6R9DA01#	±0.1pF					GRM1555C2A8R3BA01#	
			7.0pF	±0.05pF	GRM1555C2A7R0WA01#					±0.25pF	GRM1555C2A8R3CA01#
				±0.1pF	GRM1555C2A7R0BA01#				±0.5pF	GRM1555C2A8R3DA01#	
				±0.25pF	GRM1555C2A7R0CA01#				8.4pF	±0.05pF	GRM1555C2A8R4WA01#
			±0.5pF	GRM1555C2A7R0DA01#	±0.1pF					GRM1555C2A8R4BA01#	
			7.1pF	±0.05pF	GRM1555C2A7R1WA01#					±0.25pF	GRM1555C2A8R4CA01#
				±0.1pF	GRM1555C2A7R1BA01#				±0.5pF	GRM1555C2A8R4DA01#	
				±0.25pF	GRM1555C2A7R1CA01#				8.5pF	±0.05pF	GRM1555C2A8R5WA01#
			±0.5pF	GRM1555C2A7R1DA01#	±0.1pF					GRM1555C2A8R5BA01#	
			7.2pF	±0.05pF	GRM1555C2A7R2WA01#					±0.25pF	GRM1555C2A8R5CA01#
				±0.1pF	GRM1555C2A7R2BA01#				±0.5pF	GRM1555C2A8R5DA01#	
				±0.25pF	GRM1555C2A7R2CA01#				8.6pF	±0.05pF	GRM1555C2A8R6WA01#
			±0.5pF	GRM1555C2A7R2DA01#	±0.1pF					GRM1555C2A8R6BA01#	
			7.3pF	±0.05pF	GRM1555C2A7R3WA01#					±0.25pF	GRM1555C2A8R6CA01#
				±0.1pF	GRM1555C2A7R3BA01#				±0.5pF	GRM1555C2A8R6DA01#	
				±0.25pF	GRM1555C2A7R3CA01#				8.7pF	±0.05pF	GRM1555C2A8R7WA01#
			±0.5pF	GRM1555C2A7R3DA01#	±0.1pF					GRM1555C2A8R7BA01#	
			7.4pF	±0.05pF	GRM1555C2A7R4WA01#					±0.25pF	GRM1555C2A8R7CA01#
				±0.1pF	GRM1555C2A7R4BA01#				±0.5pF	GRM1555C2A8R7DA01#	
				±0.25pF	GRM1555C2A7R4CA01#				8.8pF	±0.05pF	GRM1555C2A8R8WA01#

Part number # indicates the package specification code.



GRM Series Temperature Compensating Type Part Number List

(→ 1.0×0.5mm)

T max.	Rated Voltage	TC Code	Cap.	Tol.	Part Number	T max.	Rated Voltage	TC Code	Cap.	Tol.	Part Number		
0.55mm	100Vdc	COG	8.8pF	±0.1pF	GRM1555C2A8R8BA01#	0.55mm	100Vdc	COG	18pF	±5%	GRM1555C2A180JA01#		
				±0.25pF	GRM1555C2A8R8CA01#					22pF	±2%	GRM1555C2A220GA01#	
				±0.5pF	GRM1555C2A8R8DA01#						±5%	GRM1555C2A220JA01#	
			8.9pF	±0.05pF	GRM1555C2A8R9WA01#				27pF	±2%	GRM1555C2A270GA01#		
				±0.1pF	GRM1555C2A8R9BA01#					±5%	GRM1555C2A270JA01#		
				±0.25pF	GRM1555C2A8R9CA01#				33pF	±2%	GRM1555C2A330GA01#		
			±0.5pF	GRM1555C2A8R9DA01#	±5%					GRM1555C2A330JA01#			
			9.0pF	±0.05pF	GRM1555C2A9R0WA01#				39pF	±2%	GRM1555C2A390GA01#		
				±0.1pF	GRM1555C2A9R0BA01#					±5%	GRM1555C2A390JA01#		
				±0.25pF	GRM1555C2A9R0CA01#				47pF	±2%	GRM1555C2A470GA01#		
				±0.5pF	GRM1555C2A9R0DA01#					±5%	GRM1555C2A470JA01#		
			9.1pF	±0.05pF	GRM1555C2A9R1WA01#				56pF	±2%	GRM1555C2A560GA01#		
				±0.1pF	GRM1555C2A9R1BA01#					±5%	GRM1555C2A560JA01#		
				±0.25pF	GRM1555C2A9R1CA01#				68pF	±2%	GRM1555C2A680GA01#		
				±0.5pF	GRM1555C2A9R1DA01#					±5%	GRM1555C2A680JA01#		
			9.2pF	±0.05pF	GRM1555C2A9R2WA01#				82pF	±2%	GRM1555C2A820GA01#		
				±0.1pF	GRM1555C2A9R2BA01#					±5%	GRM1555C2A820JA01#		
				±0.25pF	GRM1555C2A9R2CA01#				100pF	±2%	GRM1555C2A101GA01#		
				±0.5pF	GRM1555C2A9R2DA01#					±5%	GRM1555C2A101JA01#		
			9.3pF	±0.05pF	GRM1555C2A9R3WA01#				CK	±0.05pF	GRM1554C2AR10WA01#		
				±0.1pF	GRM1555C2A9R3BA01#					±0.05pF	GRM1554C2AR20WA01#		
				±0.25pF	GRM1555C2A9R3CA01#					±0.1pF	GRM1554C2AR20BA01#		
				±0.5pF	GRM1555C2A9R3DA01#					0.30pF	±0.05pF	GRM1554C2AR30WA01#	
			9.4pF	±0.05pF	GRM1555C2A9R4WA01#						±0.1pF	GRM1554C2AR30BA01#	
				±0.1pF	GRM1555C2A9R4BA01#					0.40pF	±0.05pF	GRM1554C2AR40WA01#	
				±0.25pF	GRM1555C2A9R4CA01#						±0.1pF	GRM1554C2AR40BA01#	
			±0.5pF	GRM1555C2A9R4DA01#	0.50pF					±0.05pF	GRM1554C2AR50WA01#		
			9.5pF	±0.05pF						GRM1555C2A9R5WA01#	±0.1pF	GRM1554C2AR50BA01#	
				±0.1pF	GRM1555C2A9R5BA01#					0.60pF	±0.05pF	GRM1554C2AR60WA01#	
				±0.25pF	GRM1555C2A9R5CA01#						±0.1pF	GRM1554C2AR60BA01#	
			±0.5pF	GRM1555C2A9R5DA01#	0.70pF					±0.05pF	GRM1554C2AR70WA01#		
			9.6pF	±0.05pF						GRM1555C2A9R6WA01#	±0.1pF	GRM1554C2AR70BA01#	
				±0.1pF	GRM1555C2A9R6BA01#					0.80pF	±0.05pF	GRM1554C2AR80WA01#	
				±0.25pF	GRM1555C2A9R6CA01#						±0.1pF	GRM1554C2AR80BA01#	
			±0.5pF	GRM1555C2A9R6DA01#	0.90pF					±0.05pF	GRM1554C2AR90WA01#		
			9.7pF	±0.05pF						GRM1555C2A9R7WA01#	±0.1pF	GRM1554C2AR90BA01#	
				±0.1pF	GRM1555C2A9R7BA01#					1.0pF	±0.05pF	GRM1554C2A1R0WA01#	
				±0.25pF	GRM1555C2A9R7CA01#						±0.1pF	GRM1554C2A1R0BA01#	
			±0.5pF	GRM1555C2A9R7DA01#	±0.25pF					GRM1554C2A1ROCA01#	1.1pF	±0.05pF	GRM1554C2A1R1WA01#
			9.8pF	±0.05pF	GRM1555C2A9R8WA01#					±0.1pF		GRM1554C2A1R1BA01#	
				±0.1pF	GRM1555C2A9R8BA01#					±0.25pF		GRM1554C2A1R1CA01#	
				±0.25pF	GRM1555C2A9R8CA01#					1.2pF	±0.05pF	GRM1554C2A1R2WA01#	
			±0.5pF	GRM1555C2A9R8DA01#	±0.1pF						GRM1554C2A1R2BA01#		
			9.9pF	±0.05pF	GRM1555C2A9R9WA01#					±0.25pF	GRM1554C2A1R2CA01#		
				±0.1pF	GRM1555C2A9R9BA01#					1.3pF	±0.05pF	GRM1554C2A1R3WA01#	
				±0.25pF	GRM1555C2A9R9CA01#						±0.1pF	GRM1554C2A1R3BA01#	
			±0.5pF	GRM1555C2A9R9DA01#	1.4pF					±0.25pF	GRM1554C2A1R3CA01#		
			10pF	±2%						GRM1555C2A100GA01#	±0.05pF	GRM1554C2A1R4WA01#	
				±5%	GRM1555C2A100JA01#					±0.1pF	GRM1554C2A1R4BA01#		
			12pF	±2%	GRM1555C2A120GA01#					±0.25pF	GRM1554C2A1R4CA01#		
				±5%	GRM1555C2A120JA01#					1.5pF	±0.05pF	GRM1554C2A1R5WA01#	
			15pF	±2%	GRM1555C2A150GA01#						±0.1pF	GRM1554C2A1R5BA01#	
				±5%	GRM1555C2A150JA01#					±0.25pF	GRM1554C2A1R5CA01#		
			18pF	±2%	GRM1555C2A180GA01#								

GRM
 GR3
 GRJ
 GR4
 GR7
 GJM
 GQM
 GA2
 GA3 GB
 GA3 GD
 GA3 GF
 LLL
 LLA
 LLM
 LLR
 NFM
 KRM
 KR3
 GMA
 GMD
 ⚠Caution /Notice

Part number # indicates the package specification code.

GRM Series Temperature Compensating Type Part Number List

(→ 1.0×0.5mm)

T max.	Rated Voltage	TC Code	Cap.	Tol.	Part Number	T max.	Rated Voltage	TC Code	Cap.	Tol.	Part Number		
0.55mm	100Vdc	CK	1.6pF	±0.05pF	GRM1554C2A1R6WA01#	0.55mm	100Vdc	CJ	3.4pF	±0.05pF	GRM1553C2A3R4WA01#		
				±0.1pF	GRM1554C2A1R6BA01#					±0.1pF	GRM1553C2A3R4BA01#		
				±0.25pF	GRM1554C2A1R6CA01#					±0.25pF	GRM1553C2A3R4CA01#		
			1.7pF	±0.05pF	GRM1554C2A1R7WA01#				3.5pF	±0.05pF	GRM1553C2A3R5WA01#		
				±0.1pF	GRM1554C2A1R7BA01#					±0.1pF	GRM1553C2A3R5BA01#		
				±0.25pF	GRM1554C2A1R7CA01#					±0.25pF	GRM1553C2A3R5CA01#		
			1.8pF	±0.05pF	GRM1554C2A1R8WA01#				3.6pF	±0.05pF	GRM1553C2A3R6WA01#		
				±0.1pF	GRM1554C2A1R8BA01#					±0.1pF	GRM1553C2A3R6BA01#		
				±0.25pF	GRM1554C2A1R8CA01#					±0.25pF	GRM1553C2A3R6CA01#		
			1.9pF	±0.05pF	GRM1554C2A1R9WA01#				3.7pF	±0.05pF	GRM1553C2A3R7WA01#		
				±0.1pF	GRM1554C2A1R9BA01#					±0.1pF	GRM1553C2A3R7BA01#		
				±0.25pF	GRM1554C2A1R9CA01#					±0.25pF	GRM1553C2A3R7CA01#		
			2.0pF	±0.05pF	GRM1554C2A2R0WA01#				3.8pF	±0.05pF	GRM1553C2A3R8WA01#		
				±0.1pF	GRM1554C2A2R0BA01#					±0.1pF	GRM1553C2A3R8BA01#		
				±0.25pF	GRM1554C2A2R0CA01#					±0.25pF	GRM1553C2A3R8CA01#		
			CJ	2.1pF	±0.05pF				GRM1553C2A2R1WA01#	CH	4.0pF	±0.05pF	GRM1552C2A4R0WA01#
					±0.1pF				GRM1553C2A2R1BA01#			±0.1pF	GRM1552C2A4R0BA01#
					±0.25pF				GRM1553C2A2R1CA01#			±0.25pF	GRM1552C2A4R0CA01#
				2.2pF	±0.05pF				GRM1553C2A2R2WA01#		4.1pF	±0.05pF	GRM1552C2A4R1WA01#
					±0.1pF				GRM1553C2A2R2BA01#			±0.1pF	GRM1552C2A4R1BA01#
					±0.25pF				GRM1553C2A2R2CA01#			±0.25pF	GRM1552C2A4R1CA01#
				2.3pF	±0.05pF				GRM1553C2A2R3WA01#		4.2pF	±0.05pF	GRM1552C2A4R2WA01#
					±0.1pF				GRM1553C2A2R3BA01#			±0.1pF	GRM1552C2A4R2BA01#
					±0.25pF				GRM1553C2A2R3CA01#			±0.25pF	GRM1552C2A4R2CA01#
				2.4pF	±0.05pF				GRM1553C2A2R4WA01#		4.3pF	±0.05pF	GRM1552C2A4R3WA01#
					±0.1pF				GRM1553C2A2R4BA01#			±0.1pF	GRM1552C2A4R3BA01#
					±0.25pF				GRM1553C2A2R4CA01#			±0.25pF	GRM1552C2A4R3CA01#
				2.5pF	±0.05pF				GRM1553C2A2R5WA01#		4.4pF	±0.05pF	GRM1552C2A4R4WA01#
					±0.1pF				GRM1553C2A2R5BA01#			±0.1pF	GRM1552C2A4R4BA01#
					±0.25pF				GRM1553C2A2R5CA01#			±0.25pF	GRM1552C2A4R4CA01#
				2.6pF	±0.05pF				GRM1553C2A2R6WA01#		4.5pF	±0.05pF	GRM1552C2A4R5WA01#
					±0.1pF				GRM1553C2A2R6BA01#			±0.1pF	GRM1552C2A4R5BA01#
					±0.25pF				GRM1553C2A2R6CA01#			±0.25pF	GRM1552C2A4R5CA01#
				2.7pF	±0.05pF				GRM1553C2A2R7WA01#		4.6pF	±0.05pF	GRM1552C2A4R6WA01#
					±0.1pF				GRM1553C2A2R7BA01#			±0.1pF	GRM1552C2A4R6BA01#
					±0.25pF				GRM1553C2A2R7CA01#			±0.25pF	GRM1552C2A4R6CA01#
		2.8pF		±0.05pF	GRM1553C2A2R8WA01#	4.7pF	±0.05pF	GRM1552C2A4R7WA01#					
				±0.1pF	GRM1553C2A2R8BA01#		±0.1pF	GRM1552C2A4R7BA01#					
				±0.25pF	GRM1553C2A2R8CA01#		±0.25pF	GRM1552C2A4R7CA01#					
		2.9pF		±0.05pF	GRM1553C2A2R9WA01#	4.8pF	±0.05pF	GRM1552C2A4R8WA01#					
				±0.1pF	GRM1553C2A2R9BA01#		±0.1pF	GRM1552C2A4R8BA01#					
				±0.25pF	GRM1553C2A2R9CA01#		±0.25pF	GRM1552C2A4R8CA01#					
		3.0pF		±0.05pF	GRM1553C2A3R0WA01#	5.0pF	±0.05pF	GRM1552C2A5R0WA01#					
				±0.1pF	GRM1553C2A3R0BA01#		±0.1pF	GRM1552C2A5R0BA01#					
				±0.25pF	GRM1553C2A3R0CA01#		±0.25pF	GRM1552C2A5R0CA01#					
		3.1pF		±0.05pF	GRM1553C2A3R1WA01#		5.1pF	±0.05pF	GRM1552C2A5R1WA01#				
				±0.1pF	GRM1553C2A3R1BA01#			±0.1pF	GRM1552C2A5R1BA01#				
				±0.25pF	GRM1553C2A3R1CA01#			±0.25pF	GRM1552C2A5R1CA01#				
		3.2pF		±0.05pF	GRM1553C2A3R2WA01#								
				±0.1pF	GRM1553C2A3R2BA01#								
				±0.25pF	GRM1553C2A3R2CA01#								
		3.3pF	±0.05pF	GRM1553C2A3R3WA01#									
			±0.1pF	GRM1553C2A3R3BA01#									
			±0.25pF	GRM1553C2A3R3CA01#									

Part number # indicates the package specification code.



GRM Series Temperature Compensating Type Part Number List

(→ 1.0×0.5mm)

T max.	Rated Voltage	TC Code	Cap.	Tol.	Part Number	T max.	Rated Voltage	TC Code	Cap.	Tol.	Part Number
0.55mm	100Vdc	CH	5.1pF	±0.5pF	GRM1552C2A5R1DA01#	0.55mm	100Vdc	CH	6.5pF	±0.1pF	GRM1552C2A6R5BA01#
				±0.05pF	GRM1552C2A5R2WA01#					±0.25pF	GRM1552C2A6R5CA01#
			±0.1pF	GRM1552C2A5R2BA01#	±0.5pF					GRM1552C2A6R5DA01#	
			5.2pF	±0.25pF	GRM1552C2A5R2CA01#				6.6pF	±0.05pF	GRM1552C2A6R6WA01#
				±0.5pF	GRM1552C2A5R2DA01#					±0.1pF	GRM1552C2A6R6BA01#
				±0.05pF	GRM1552C2A5R3WA01#					±0.25pF	GRM1552C2A6R6CA01#
				±0.1pF	GRM1552C2A5R3BA01#					±0.5pF	GRM1552C2A6R6DA01#
			5.3pF	±0.25pF	GRM1552C2A5R3CA01#				6.7pF	±0.05pF	GRM1552C2A6R7WA01#
				±0.5pF	GRM1552C2A5R3DA01#					±0.1pF	GRM1552C2A6R7BA01#
				±0.05pF	GRM1552C2A5R4WA01#					±0.25pF	GRM1552C2A6R7CA01#
				±0.1pF	GRM1552C2A5R4BA01#					±0.5pF	GRM1552C2A6R7DA01#
			5.4pF	±0.25pF	GRM1552C2A5R4CA01#				6.8pF	±0.05pF	GRM1552C2A6R8WA01#
				±0.5pF	GRM1552C2A5R4DA01#					±0.1pF	GRM1552C2A6R8BA01#
				±0.05pF	GRM1552C2A5R5WA01#					±0.25pF	GRM1552C2A6R8CA01#
				±0.1pF	GRM1552C2A5R5BA01#					±0.5pF	GRM1552C2A6R8DA01#
			5.5pF	±0.25pF	GRM1552C2A5R5CA01#				6.9pF	±0.05pF	GRM1552C2A6R9WA01#
				±0.5pF	GRM1552C2A5R5DA01#					±0.1pF	GRM1552C2A6R9BA01#
				±0.05pF	GRM1552C2A5R6WA01#					±0.25pF	GRM1552C2A6R9CA01#
				±0.1pF	GRM1552C2A5R6BA01#					±0.5pF	GRM1552C2A6R9DA01#
			5.6pF	±0.25pF	GRM1552C2A5R6CA01#				7.0pF	±0.05pF	GRM1552C2A7R0WA01#
				±0.5pF	GRM1552C2A5R6DA01#					±0.1pF	GRM1552C2A7R0BA01#
				±0.05pF	GRM1552C2A5R7WA01#					±0.25pF	GRM1552C2A7R0CA01#
				±0.1pF	GRM1552C2A5R7BA01#					±0.5pF	GRM1552C2A7R0DA01#
			5.7pF	±0.25pF	GRM1552C2A5R7CA01#				7.1pF	±0.05pF	GRM1552C2A7R1WA01#
				±0.5pF	GRM1552C2A5R7DA01#					±0.1pF	GRM1552C2A7R1BA01#
				±0.05pF	GRM1552C2A5R8WA01#					±0.25pF	GRM1552C2A7R1CA01#
				±0.1pF	GRM1552C2A5R8BA01#					±0.5pF	GRM1552C2A7R1DA01#
			5.8pF	±0.25pF	GRM1552C2A5R8CA01#				7.2pF	±0.05pF	GRM1552C2A7R2WA01#
				±0.5pF	GRM1552C2A5R8DA01#					±0.1pF	GRM1552C2A7R2BA01#
				±0.05pF	GRM1552C2A5R9WA01#					±0.25pF	GRM1552C2A7R2CA01#
				±0.1pF	GRM1552C2A5R9BA01#					±0.5pF	GRM1552C2A7R2DA01#
			5.9pF	±0.25pF	GRM1552C2A5R9CA01#				7.3pF	±0.05pF	GRM1552C2A7R3WA01#
				±0.5pF	GRM1552C2A5R9DA01#					±0.1pF	GRM1552C2A7R3BA01#
				±0.05pF	GRM1552C2A6R0WA01#					±0.25pF	GRM1552C2A7R3CA01#
				±0.1pF	GRM1552C2A6R0BA01#					±0.5pF	GRM1552C2A7R3DA01#
			6.0pF	±0.25pF	GRM1552C2A6R0CA01#				7.4pF	±0.05pF	GRM1552C2A7R4WA01#
				±0.5pF	GRM1552C2A6R0DA01#					±0.1pF	GRM1552C2A7R4BA01#
				±0.05pF	GRM1552C2A6R1WA01#					±0.25pF	GRM1552C2A7R4CA01#
				±0.1pF	GRM1552C2A6R1BA01#					±0.5pF	GRM1552C2A7R4DA01#
			6.1pF	±0.25pF	GRM1552C2A6R1CA01#				7.5pF	±0.05pF	GRM1552C2A7R5WA01#
				±0.5pF	GRM1552C2A6R1DA01#					±0.1pF	GRM1552C2A7R5BA01#
				±0.05pF	GRM1552C2A6R2WA01#					±0.25pF	GRM1552C2A7R5CA01#
				±0.1pF	GRM1552C2A6R2BA01#					±0.5pF	GRM1552C2A7R5DA01#
			6.2pF	±0.25pF	GRM1552C2A6R2CA01#				7.6pF	±0.05pF	GRM1552C2A7R6WA01#
				±0.5pF	GRM1552C2A6R2DA01#					±0.1pF	GRM1552C2A7R6BA01#
				±0.05pF	GRM1552C2A6R3WA01#					±0.25pF	GRM1552C2A7R6CA01#
				±0.1pF	GRM1552C2A6R3BA01#					±0.5pF	GRM1552C2A7R6DA01#
			6.3pF	±0.25pF	GRM1552C2A6R3CA01#				7.7pF	±0.05pF	GRM1552C2A7R7WA01#
				±0.5pF	GRM1552C2A6R3DA01#					±0.1pF	GRM1552C2A7R7BA01#
				±0.05pF	GRM1552C2A6R4WA01#					±0.25pF	GRM1552C2A7R7CA01#
				±0.1pF	GRM1552C2A6R4BA01#					±0.5pF	GRM1552C2A7R7DA01#
			6.4pF	±0.25pF	GRM1552C2A6R4CA01#				7.8pF	±0.05pF	GRM1552C2A7R8WA01#
				±0.5pF	GRM1552C2A6R4DA01#					±0.1pF	GRM1552C2A7R8BA01#
				±0.05pF	GRM1552C2A6R5WA01#					±0.25pF	GRM1552C2A7R8CA01#
				±0.1pF	GRM1552C2A6R5BA01#						

- GRM
- GR3
- GRJ
- GR4
- GR7
- GJM
- GQM
- GA2
- GA3 GB
- GA3 GD
- GA3 GF
- LLL
- LLA
- LLM
- LLR
- NFM
- KRM
- KR3
- GMA
- GMD
- ⚠Caution /Notice

Part number # indicates the package specification code.

GRM Series Temperature Compensating Type Part Number List

(→ 1.0×0.5mm)

T max.	Rated Voltage	TC Code	Cap.	Tol.	Part Number	T max.	Rated Voltage	TC Code	Cap.	Tol.	Part Number	
0.55mm	100Vdc	CH	7.8pF	±0.5pF	GRM1552C2A7R8DA01#	0.55mm	100Vdc	CH	9.2pF	±0.1pF	GRM1552C2A9R2BA01#	
				±0.05pF	GRM1552C2A7R9WA01#					±0.25pF	GRM1552C2A9R2CA01#	
				±0.1pF	GRM1552C2A7R9BA01#					±0.5pF	GRM1552C2A9R2DA01#	
			7.9pF	±0.25pF	GRM1552C2A7R9CA01#				9.3pF	±0.05pF	GRM1552C2A9R3WA01#	
				±0.5pF	GRM1552C2A7R9DA01#					±0.1pF	GRM1552C2A9R3BA01#	
				±0.05pF	GRM1552C2A8R0WA01#					±0.25pF	GRM1552C2A9R3CA01#	
				±0.1pF	GRM1552C2A8R0BA01#					±0.5pF	GRM1552C2A9R3DA01#	
			8.0pF	±0.25pF	GRM1552C2A8R0CA01#				9.4pF	±0.05pF	GRM1552C2A9R4WA01#	
				±0.5pF	GRM1552C2A8R0DA01#					±0.1pF	GRM1552C2A9R4BA01#	
				±0.05pF	GRM1552C2A8R1WA01#					±0.25pF	GRM1552C2A9R4CA01#	
			8.1pF	±0.1pF	GRM1552C2A8R1BA01#				9.5pF	±0.5pF	GRM1552C2A9R4DA01#	
				±0.25pF	GRM1552C2A8R1CA01#					±0.05pF	GRM1552C2A9R5WA01#	
				±0.5pF	GRM1552C2A8R1DA01#					±0.1pF	GRM1552C2A9R5BA01#	
			8.2pF	±0.05pF	GRM1552C2A8R2WA01#				9.6pF	±0.25pF	GRM1552C2A9R5CA01#	
				±0.1pF	GRM1552C2A8R2BA01#					±0.5pF	GRM1552C2A9R5DA01#	
				±0.25pF	GRM1552C2A8R2CA01#					9.7pF	±0.05pF	GRM1552C2A9R6WA01#
				±0.5pF	GRM1552C2A8R2DA01#						±0.1pF	GRM1552C2A9R6BA01#
			±0.05pF	GRM1552C2A8R3WA01#	±0.25pF				GRM1552C2A9R6CA01#			
			8.3pF	±0.1pF	GRM1552C2A8R3BA01#				9.8pF	±0.5pF	GRM1552C2A9R6DA01#	
				±0.25pF	GRM1552C2A8R3CA01#					±0.05pF	GRM1552C2A9R7WA01#	
				±0.5pF	GRM1552C2A8R3DA01#					±0.1pF	GRM1552C2A9R7BA01#	
			8.4pF	±0.05pF	GRM1552C2A8R4WA01#				9.9pF	±0.25pF	GRM1552C2A9R7CA01#	
				±0.1pF	GRM1552C2A8R4BA01#					±0.5pF	GRM1552C2A9R7DA01#	
				±0.25pF	GRM1552C2A8R4CA01#					10pF	±2%	GRM1552C2A100GA01#
				±0.5pF	GRM1552C2A8R4DA01#						±5%	GRM1552C2A100JA01#
			±0.05pF	GRM1552C2A8R5WA01#	12pF				±2%		GRM1552C2A120GA01#	
			±0.1pF	GRM1552C2A8R5BA01#					±5%	GRM1552C2A120JA01#		
			±0.25pF	GRM1552C2A8R5CA01#					15pF	±2%	GRM1552C2A150GA01#	
			±0.5pF	GRM1552C2A8R5DA01#	±5%					GRM1552C2A150JA01#		
			±0.05pF	GRM1552C2A8R6WA01#	18pF					±2%	GRM1552C2A180GA01#	
			±0.1pF	GRM1552C2A8R6BA01#					±5%	GRM1552C2A180JA01#		
			±0.25pF	GRM1552C2A8R6CA01#					22pF	±2%	GRM1552C2A220GA01#	
			±0.5pF	GRM1552C2A8R6DA01#	±5%					GRM1552C2A220JA01#		
			±0.05pF	GRM1552C2A8R7WA01#	27pF					±2%	GRM1552C2A270GA01#	
			±0.1pF	GRM1552C2A8R7BA01#					±5%	GRM1552C2A270JA01#		
			±0.25pF	GRM1552C2A8R7CA01#					33pF	±2%	GRM1552C2A330GA01#	
			±0.5pF	GRM1552C2A8R7DA01#	±5%					GRM1552C2A330JA01#		
			±0.05pF	GRM1552C2A8R8WA01#	39pF					±2%	GRM1552C2A390GA01#	
			±0.1pF	GRM1552C2A8R8BA01#					±5%	GRM1552C2A390JA01#		
			±0.25pF	GRM1552C2A8R8CA01#					47pF	±2%	GRM1552C2A470GA01#	
			±0.5pF	GRM1552C2A8R8DA01#	±5%					GRM1552C2A470JA01#		
			±0.05pF	GRM1552C2A8R9WA01#	56pF					±2%	GRM1552C2A560GA01#	
			±0.1pF	GRM1552C2A8R9BA01#					±5%	GRM1552C2A560JA01#		
			±0.25pF	GRM1552C2A8R9CA01#					68pF	±2%	GRM1552C2A680GA01#	
			±0.5pF	GRM1552C2A8R9DA01#	±5%					GRM1552C2A680JA01#		
			±0.05pF	GRM1552C2A9R0WA01#	82pF					±2%	GRM1552C2A820GA01#	
			±0.1pF	GRM1552C2A9R0BA01#								
			±0.25pF	GRM1552C2A9R0CA01#								
			9.0pF	±0.5pF	GRM1552C2A9R0DA01#							
				±0.05pF	GRM1552C2A9R1WA01#							
				±0.1pF	GRM1552C2A9R1BA01#							
			9.1pF	±0.25pF	GRM1552C2A9R1CA01#							
				±0.5pF	GRM1552C2A9R1DA01#							
				±0.05pF	GRM1552C2A9R2WA01#							

Part number # indicates the package specification code.



GRM Series Temperature Compensating Type Part Number List

(→ 1.0×0.5mm)

T max.	Rated Voltage	TC Code	Cap.	Tol.	Part Number	T max.	Rated Voltage	TC Code	Cap.	Tol.	Part Number
0.55mm	100Vdc	CH	82pF	±5%	GRM1552C2A820JA01#	0.55mm	50Vdc	COG	2.1pF	±0.1pF	GRM1555C1H2R1BA01#
			100pF	±2%	GRM1552C2A101GA01#				±0.25pF	GRM1555C1H2R1CA01#	
				±5%	GRM1552C2A101JA01#				2.2pF	±0.05pF	GRM1555C1H2R2WA01#
	50Vdc	COG	0.10pF	±0.05pF	GRM1555C1HR10WA01#				±0.1pF	GRM1555C1H2R2BA01#	
0.20pF			±0.05pF	GRM1555C1HR20WA01#	±0.25pF	GRM1555C1H2R2CA01#					
			±0.1pF	GRM1555C1HR20BA01#	2.3pF	±0.05pF	GRM1555C1H2R3WA01#				
0.30pF			±0.05pF	GRM1555C1HR30WA01#	±0.1pF	GRM1555C1H2R3BA01#					
			±0.1pF	GRM1555C1HR30BA01#	±0.25pF	GRM1555C1H2R3CA01#					
0.40pF			±0.05pF	GRM1555C1HR40WA01#	2.4pF	±0.05pF	GRM1555C1H2R4WA01#				
			±0.1pF	GRM1555C1HR40BA01#	±0.1pF	GRM1555C1H2R4BA01#					
0.50pF			±0.05pF	GRM1555C1HR50WA01#	±0.25pF	GRM1555C1H2R4CA01#					
			±0.1pF	GRM1555C1HR50BA01#	2.5pF	±0.05pF	GRM1555C1H2R5WA01#				
0.60pF			±0.05pF	GRM1555C1HR60WA01#	±0.1pF	GRM1555C1H2R5BA01#					
			±0.1pF	GRM1555C1HR60BA01#	±0.25pF	GRM1555C1H2R5CA01#					
0.70pF			±0.05pF	GRM1555C1HR70WA01#	2.6pF	±0.05pF	GRM1555C1H2R6WA01#				
			±0.1pF	GRM1555C1HR70BA01#	±0.1pF	GRM1555C1H2R6BA01#					
0.80pF			±0.05pF	GRM1555C1HR80WA01#	±0.25pF	GRM1555C1H2R6CA01#					
			±0.1pF	GRM1555C1HR80BA01#	2.7pF	±0.05pF	GRM1555C1H2R7WA01#				
0.90pF			±0.05pF	GRM1555C1HR90WA01#	±0.1pF	GRM1555C1H2R7BA01#					
			±0.1pF	GRM1555C1HR90BA01#	±0.25pF	GRM1555C1H2R7CA01#					
1.0pF			±0.05pF	GRM1555C1H1R0WA01#	2.8pF	±0.05pF	GRM1555C1H2R8WA01#				
			±0.1pF	GRM1555C1H1R0BA01#	±0.1pF	GRM1555C1H2R8BA01#					
			±0.25pF	GRM1555C1H1R0CA01#	±0.25pF	GRM1555C1H2R8CA01#					
1.1pF			±0.05pF	GRM1555C1H1R1WA01#	2.9pF	±0.05pF	GRM1555C1H2R9WA01#				
			±0.1pF	GRM1555C1H1R1BA01#	±0.1pF	GRM1555C1H2R9BA01#					
			±0.25pF	GRM1555C1H1R1CA01#	±0.25pF	GRM1555C1H2R9CA01#					
1.2pF			±0.05pF	GRM1555C1H1R2WA01#	3.0pF	±0.05pF	GRM1555C1H3R0WA01#				
			±0.1pF	GRM1555C1H1R2BA01#	±0.1pF	GRM1555C1H3R0BA01#					
			±0.25pF	GRM1555C1H1R2CA01#	±0.25pF	GRM1555C1H3R0CA01#					
1.3pF			±0.05pF	GRM1555C1H1R3WA01#	3.1pF	±0.05pF	GRM1555C1H3R1WA01#				
			±0.1pF	GRM1555C1H1R3BA01#	±0.1pF	GRM1555C1H3R1BA01#					
			±0.25pF	GRM1555C1H1R3CA01#	±0.25pF	GRM1555C1H3R1CA01#					
1.4pF			±0.05pF	GRM1555C1H1R4WA01#	3.2pF	±0.05pF	GRM1555C1H3R2WA01#				
			±0.1pF	GRM1555C1H1R4BA01#	±0.1pF	GRM1555C1H3R2BA01#					
			±0.25pF	GRM1555C1H1R4CA01#	±0.25pF	GRM1555C1H3R2CA01#					
1.5pF			±0.05pF	GRM1555C1H1R5WA01#	3.3pF	±0.05pF	GRM1555C1H3R3WA01#				
			±0.1pF	GRM1555C1H1R5BA01#	±0.1pF	GRM1555C1H3R3BA01#					
			±0.25pF	GRM1555C1H1R5CA01#	±0.25pF	GRM1555C1H3R3CA01#					
1.6pF			±0.05pF	GRM1555C1H1R6WA01#	3.4pF	±0.05pF	GRM1555C1H3R4WA01#				
			±0.1pF	GRM1555C1H1R6BA01#	±0.1pF	GRM1555C1H3R4BA01#					
			±0.25pF	GRM1555C1H1R6CA01#	±0.25pF	GRM1555C1H3R4CA01#					
1.7pF			±0.05pF	GRM1555C1H1R7WA01#	3.5pF	±0.05pF	GRM1555C1H3R5WA01#				
			±0.1pF	GRM1555C1H1R7BA01#	±0.1pF	GRM1555C1H3R5BA01#					
			±0.25pF	GRM1555C1H1R7CA01#	±0.25pF	GRM1555C1H3R5CA01#					
1.8pF			±0.05pF	GRM1555C1H1R8WA01#	3.6pF	±0.05pF	GRM1555C1H3R6WA01#				
	±0.1pF	GRM1555C1H1R8BA01#	±0.1pF	GRM1555C1H3R6BA01#							
	±0.25pF	GRM1555C1H1R8CA01#	±0.25pF	GRM1555C1H3R6CA01#							
1.9pF	±0.05pF	GRM1555C1H1R9WA01#	3.7pF	±0.05pF	GRM1555C1H3R7WA01#						
	±0.1pF	GRM1555C1H1R9BA01#	±0.1pF	GRM1555C1H3R7BA01#							
	±0.25pF	GRM1555C1H1R9CA01#	±0.25pF	GRM1555C1H3R7CA01#							
2.0pF	±0.05pF	GRM1555C1H2R0WA01#	3.8pF	±0.05pF	GRM1555C1H3R8WA01#						
	±0.1pF	GRM1555C1H2R0BA01#	±0.1pF	GRM1555C1H3R8BA01#							
	±0.25pF	GRM1555C1H2R0CA01#	±0.25pF	GRM1555C1H3R8CA01#							
2.1pF	±0.05pF	GRM1555C1H2R1WA01#	3.9pF	±0.05pF	GRM1555C1H3R9WA01#						

- GRM
- GR3
- GRJ
- GR4
- GR7
- GJM
- GQM
- GA2
- GA3 GB
- GA3 GD
- GA3 GF
- LLL
- LLA
- LLM
- LLR
- NFM
- KRM
- KR3
- GMA
- GMD
- ⚠Caution /Notice

Part number # indicates the package specification code.

GRM Series Temperature Compensating Type Part Number List

(→ 1.0×0.5mm)

T max.	Rated Voltage	TC Code	Cap.	Tol.	Part Number
0.55mm	50Vdc	COG	3.9pF	±0.1pF	GRM1555C1H3R9BA01#
				±0.25pF	GRM1555C1H3R9CA01#
			4.0pF	±0.05pF	GRM1555C1H4R0WA01#
				±0.1pF	GRM1555C1H4R0BA01#
				±0.25pF	GRM1555C1H4R0CA01#
			4.1pF	±0.05pF	GRM1555C1H4R1WA01#
				±0.1pF	GRM1555C1H4R1BA01#
				±0.25pF	GRM1555C1H4R1CA01#
			4.2pF	±0.05pF	GRM1555C1H4R2WA01#
				±0.1pF	GRM1555C1H4R2BA01#
				±0.25pF	GRM1555C1H4R2CA01#
			4.3pF	±0.05pF	GRM1555C1H4R3WA01#
				±0.1pF	GRM1555C1H4R3BA01#
				±0.25pF	GRM1555C1H4R3CA01#
			4.4pF	±0.05pF	GRM1555C1H4R4WA01#
				±0.1pF	GRM1555C1H4R4BA01#
				±0.25pF	GRM1555C1H4R4CA01#
			4.5pF	±0.05pF	GRM1555C1H4R5WA01#
				±0.1pF	GRM1555C1H4R5BA01#
				±0.25pF	GRM1555C1H4R5CA01#
			4.6pF	±0.05pF	GRM1555C1H4R6WA01#
				±0.1pF	GRM1555C1H4R6BA01#
				±0.25pF	GRM1555C1H4R6CA01#
			4.7pF	±0.05pF	GRM1555C1H4R7WA01#
				±0.1pF	GRM1555C1H4R7BA01#
				±0.25pF	GRM1555C1H4R7CA01#
			4.8pF	±0.05pF	GRM1555C1H4R8WA01#
				±0.1pF	GRM1555C1H4R8BA01#
				±0.25pF	GRM1555C1H4R8CA01#
			4.9pF	±0.05pF	GRM1555C1H4R9WA01#
				±0.1pF	GRM1555C1H4R9BA01#
				±0.25pF	GRM1555C1H4R9CA01#
			5.0pF	±0.05pF	GRM1555C1H5R0WA01#
				±0.1pF	GRM1555C1H5R0BA01#
				±0.25pF	GRM1555C1H5R0CA01#
			5.1pF	±0.05pF	GRM1555C1H5R1WA01#
				±0.1pF	GRM1555C1H5R1BA01#
				±0.25pF	GRM1555C1H5R1CA01#
				±0.5pF	GRM1555C1H5R1DA01#
			5.2pF	±0.05pF	GRM1555C1H5R2WA01#
				±0.1pF	GRM1555C1H5R2BA01#
				±0.25pF	GRM1555C1H5R2CA01#
				±0.5pF	GRM1555C1H5R2DA01#
			5.3pF	±0.05pF	GRM1555C1H5R3WA01#
				±0.1pF	GRM1555C1H5R3BA01#
				±0.25pF	GRM1555C1H5R3CA01#
				±0.5pF	GRM1555C1H5R3DA01#
			5.4pF	±0.05pF	GRM1555C1H5R4WA01#
				±0.1pF	GRM1555C1H5R4BA01#
				±0.25pF	GRM1555C1H5R4CA01#
				±0.5pF	GRM1555C1H5R4DA01#
5.5pF	±0.05pF	GRM1555C1H5R5WA01#			
	±0.1pF	GRM1555C1H5R5BA01#			
	±0.25pF	GRM1555C1H5R5CA01#			

T max.	Rated Voltage	TC Code	Cap.	Tol.	Part Number
0.55mm	50Vdc	COG	5.5pF	±0.5pF	GRM1555C1H5R5DA01#
			5.6pF	±0.05pF	GRM1555C1H5R6WA01#
				±0.1pF	GRM1555C1H5R6BA01#
				±0.25pF	GRM1555C1H5R6CA01#
				±0.5pF	GRM1555C1H5R6DA01#
			5.7pF	±0.05pF	GRM1555C1H5R7WA01#
				±0.1pF	GRM1555C1H5R7BA01#
				±0.25pF	GRM1555C1H5R7CA01#
				±0.5pF	GRM1555C1H5R7DA01#
			5.8pF	±0.05pF	GRM1555C1H5R8WA01#
				±0.1pF	GRM1555C1H5R8BA01#
				±0.25pF	GRM1555C1H5R8CA01#
			5.9pF	±0.05pF	GRM1555C1H5R9WA01#
				±0.1pF	GRM1555C1H5R9BA01#
				±0.25pF	GRM1555C1H5R9CA01#
			6.0pF	±0.05pF	GRM1555C1H6R0WA01#
				±0.1pF	GRM1555C1H6R0BA01#
				±0.25pF	GRM1555C1H6R0CA01#
				±0.5pF	GRM1555C1H6R0DA01#
			6.1pF	±0.05pF	GRM1555C1H6R1WA01#
				±0.1pF	GRM1555C1H6R1BA01#
				±0.25pF	GRM1555C1H6R1CA01#
				±0.5pF	GRM1555C1H6R1DA01#
			6.2pF	±0.05pF	GRM1555C1H6R2WA01#
				±0.1pF	GRM1555C1H6R2BA01#
				±0.25pF	GRM1555C1H6R2CA01#
				±0.5pF	GRM1555C1H6R2DA01#
			6.3pF	±0.05pF	GRM1555C1H6R3WA01#
				±0.1pF	GRM1555C1H6R3BA01#
				±0.25pF	GRM1555C1H6R3CA01#
				±0.5pF	GRM1555C1H6R3DA01#
			6.4pF	±0.05pF	GRM1555C1H6R4WA01#
				±0.1pF	GRM1555C1H6R4BA01#
				±0.25pF	GRM1555C1H6R4CA01#
				±0.5pF	GRM1555C1H6R4DA01#
			6.5pF	±0.05pF	GRM1555C1H6R5WA01#
				±0.1pF	GRM1555C1H6R5BA01#
				±0.25pF	GRM1555C1H6R5CA01#
				±0.5pF	GRM1555C1H6R5DA01#
			6.6pF	±0.05pF	GRM1555C1H6R6WA01#
				±0.1pF	GRM1555C1H6R6BA01#
				±0.25pF	GRM1555C1H6R6CA01#
				±0.5pF	GRM1555C1H6R6DA01#
			6.7pF	±0.05pF	GRM1555C1H6R7WA01#
				±0.1pF	GRM1555C1H6R7BA01#
				±0.25pF	GRM1555C1H6R7CA01#
				±0.5pF	GRM1555C1H6R7DA01#
			6.8pF	±0.05pF	GRM1555C1H6R8WA01#
				±0.1pF	GRM1555C1H6R8BA01#
				±0.25pF	GRM1555C1H6R8CA01#
				±0.5pF	GRM1555C1H6R8DA01#
6.9pF	±0.05pF	GRM1555C1H6R9WA01#			

Part number # indicates the package specification code.

GRM
 GR3
 GRJ
 GR4
 GR7
 GJM
 GQM
 GA2
 GA3 GB
 GA3 GD
 GA3 GF
 LLL
 LLA
 LLM
 LLR
 NFM
 KRM
 KR3
 GMA
 GMD
 ⚠Caution /Notice

GRM Series Temperature Compensating Type Part Number List

(→ 1.0×0.5mm)

T max.	Rated Voltage	TC Code	Cap.	Tol.	Part Number	T max.	Rated Voltage	TC Code	Cap.	Tol.	Part Number	
0.55mm	50Vdc	COG	6.9pF	±0.1pF	GRM1555C1H6R9BA01#	0.55mm	50Vdc	COG	8.2pF	±0.5pF	GRM1555C1H8R2DA01#	
				±0.25pF	GRM1555C1H6R9CA01#					8.3pF	±0.05pF	GRM1555C1H8R3WA01#
				±0.5pF	GRM1555C1H6R9DA01#						±0.1pF	GRM1555C1H8R3BA01#
			7.0pF	±0.05pF	GRM1555C1H7R0WA01#				±0.25pF		GRM1555C1H8R3CA01#	
				±0.1pF	GRM1555C1H7R0BA01#				±0.5pF	GRM1555C1H8R3DA01#		
				±0.25pF	GRM1555C1H7R0CA01#				8.4pF	±0.05pF	GRM1555C1H8R4WA01#	
			±0.5pF	GRM1555C1H7R0DA01#	±0.1pF					GRM1555C1H8R4BA01#		
			7.1pF	±0.05pF	GRM1555C1H7R1WA01#					±0.25pF	GRM1555C1H8R4CA01#	
				±0.1pF	GRM1555C1H7R1BA01#				±0.5pF	GRM1555C1H8R4DA01#		
				±0.25pF	GRM1555C1H7R1CA01#				8.5pF	±0.05pF	GRM1555C1H8R5WA01#	
			±0.5pF	GRM1555C1H7R1DA01#	±0.1pF					GRM1555C1H8R5BA01#		
			7.2pF	±0.05pF	GRM1555C1H7R2WA01#					±0.25pF	GRM1555C1H8R5CA01#	
				±0.1pF	GRM1555C1H7R2BA01#				±0.5pF	GRM1555C1H8R5DA01#		
				±0.25pF	GRM1555C1H7R2CA01#				8.6pF	±0.05pF	GRM1555C1H8R6WA01#	
			±0.5pF	GRM1555C1H7R2DA01#	±0.1pF					GRM1555C1H8R6BA01#		
			7.3pF	±0.05pF	GRM1555C1H7R3WA01#					±0.25pF	GRM1555C1H8R6CA01#	
				±0.1pF	GRM1555C1H7R3BA01#				±0.5pF	GRM1555C1H8R6DA01#		
				±0.25pF	GRM1555C1H7R3CA01#				8.7pF	±0.05pF	GRM1555C1H8R7WA01#	
			±0.5pF	GRM1555C1H7R3DA01#	±0.1pF					GRM1555C1H8R7BA01#		
			7.4pF	±0.05pF	GRM1555C1H7R4WA01#					±0.25pF	GRM1555C1H8R7CA01#	
				±0.1pF	GRM1555C1H7R4BA01#				±0.5pF	GRM1555C1H8R7DA01#		
				±0.25pF	GRM1555C1H7R4CA01#				8.8pF	±0.05pF	GRM1555C1H8R8WA01#	
			±0.5pF	GRM1555C1H7R4DA01#	±0.1pF					GRM1555C1H8R8BA01#		
			7.5pF	±0.05pF	GRM1555C1H7R5WA01#					±0.25pF	GRM1555C1H8R8CA01#	
				±0.1pF	GRM1555C1H7R5BA01#				±0.5pF	GRM1555C1H8R8DA01#		
				±0.25pF	GRM1555C1H7R5CA01#				8.9pF	±0.05pF	GRM1555C1H8R9WA01#	
			±0.5pF	GRM1555C1H7R5DA01#	±0.1pF					GRM1555C1H8R9BA01#		
			7.6pF	±0.05pF	GRM1555C1H7R6WA01#					±0.25pF	GRM1555C1H8R9CA01#	
				±0.1pF	GRM1555C1H7R6BA01#				±0.5pF	GRM1555C1H8R9DA01#		
				±0.25pF	GRM1555C1H7R6CA01#				9.0pF	±0.05pF	GRM1555C1H9R0WA01#	
			±0.5pF	GRM1555C1H7R6DA01#	±0.1pF					GRM1555C1H9R0BA01#		
			7.7pF	±0.05pF	GRM1555C1H7R7WA01#					±0.25pF	GRM1555C1H9R0CA01#	
				±0.1pF	GRM1555C1H7R7BA01#				±0.5pF	GRM1555C1H9R0DA01#		
				±0.25pF	GRM1555C1H7R7CA01#				9.1pF	±0.05pF	GRM1555C1H9R1WA01#	
			±0.5pF	GRM1555C1H7R7DA01#	±0.1pF					GRM1555C1H9R1BA01#		
			7.8pF	±0.05pF	GRM1555C1H7R8WA01#					±0.25pF	GRM1555C1H9R1CA01#	
				±0.1pF	GRM1555C1H7R8BA01#				±0.5pF	GRM1555C1H9R1DA01#		
				±0.25pF	GRM1555C1H7R8CA01#				9.2pF	±0.05pF	GRM1555C1H9R2WA01#	
			±0.5pF	GRM1555C1H7R8DA01#	±0.1pF					GRM1555C1H9R2BA01#		
			7.9pF	±0.05pF	GRM1555C1H7R9WA01#					±0.25pF	GRM1555C1H9R2CA01#	
				±0.1pF	GRM1555C1H7R9BA01#				±0.5pF	GRM1555C1H9R2DA01#		
				±0.25pF	GRM1555C1H7R9CA01#				9.3pF	±0.05pF	GRM1555C1H9R3WA01#	
			±0.5pF	GRM1555C1H7R9DA01#	±0.1pF					GRM1555C1H9R3BA01#		
			8.0pF	±0.05pF	GRM1555C1H8R0WA01#					±0.25pF	GRM1555C1H9R3CA01#	
				±0.1pF	GRM1555C1H8R0BA01#				±0.5pF	GRM1555C1H9R3DA01#		
				±0.25pF	GRM1555C1H8R0CA01#				9.4pF	±0.05pF	GRM1555C1H9R4WA01#	
			±0.5pF	GRM1555C1H8R0DA01#	±0.1pF					GRM1555C1H9R4BA01#		
			8.1pF	±0.05pF	GRM1555C1H8R1WA01#					±0.25pF	GRM1555C1H9R4CA01#	
				±0.1pF	GRM1555C1H8R1BA01#				±0.5pF	GRM1555C1H9R4DA01#		
				±0.25pF	GRM1555C1H8R1CA01#				9.5pF	±0.05pF	GRM1555C1H9R5WA01#	
			±0.5pF	GRM1555C1H8R1DA01#	±0.1pF					GRM1555C1H9R5BA01#		
			8.2pF	±0.05pF	GRM1555C1H8R2WA01#					±0.25pF	GRM1555C1H9R5CA01#	
				±0.1pF	GRM1555C1H8R2BA01#				±0.5pF	GRM1555C1H9R5DA01#		
				±0.25pF	GRM1555C1H8R2CA01#				9.6pF	±0.05pF	GRM1555C1H9R6WA01#	

GRM
 GR3
 GRJ
 GR4
 GR7
 GJM
 GQM
 GA2
 GA3 GB
 GA3 GD
 GA3 GF
 LLL
 LLA
 LLM
 LLR
 NFM
 KRM
 KR3
 GMA
 GMD
 ⚠Caution /Notice

Part number # indicates the package specification code.

GRM Series Temperature Compensating Type Part Number List

(→ 1.0×0.5mm)

T max.	Rated Voltage	TC Code	Cap.	Tol.	Part Number	T max.	Rated Voltage	TC Code	Cap.	Tol.	Part Number	
0.55mm	50Vdc	COG	9.6pF	±0.1pF	GRM1555C1H9R6BA01#	0.55mm	50Vdc	COG	390pF	±5%	GRM1555C1H391JA01#	
				±0.25pF	GRM1555C1H9R6CA01#					470pF	±2%	GRM1555C1H471GA01#
				±0.5pF	GRM1555C1H9R6DA01#						±5%	GRM1555C1H471JA01#
			9.7pF	±0.05pF	GRM1555C1H9R7WA01#				560pF		±2%	GRM1555C1H561GA01#
				±0.1pF	GRM1555C1H9R7BA01#					±5%	GRM1555C1H561JA01#	
				±0.25pF	GRM1555C1H9R7CA01#					680pF	±2%	GRM1555C1H681GA01#
			±0.5pF	GRM1555C1H9R7DA01#	±5%				GRM1555C1H681JA01#			
			9.8pF	±0.05pF	GRM1555C1H9R8WA01#				820pF		±2%	GRM1555C1H821GA01#
				±0.1pF	GRM1555C1H9R8BA01#					±5%	GRM1555C1H821JA01#	
				±0.25pF	GRM1555C1H9R8CA01#					1000pF	±2%	GRM1555C1H102GA01#
				±0.5pF	GRM1555C1H9R8DA01#						±5%	GRM1555C1H102JA01#
			9.9pF	±0.05pF	GRM1555C1H9R9WA01#				CK	0.10pF	±0.05pF	GRM1554C1HR10WA01#
				±0.1pF	GRM1555C1H9R9BA01#					0.20pF	±0.05pF	GRM1554C1HR20WA01#
				±0.25pF	GRM1555C1H9R9CA01#					±0.1pF	GRM1554C1HR20BA01#	
				±0.5pF	GRM1555C1H9R9DA01#					0.30pF	±0.05pF	GRM1554C1HR30WA01#
			10pF	±2%	GRM1555C1H100GA01#						±0.1pF	GRM1554C1HR30BA01#
				±5%	GRM1555C1H100JA01#					0.40pF	±0.05pF	GRM1554C1HR40WA01#
			12pF	±2%	GRM1555C1H120GA01#						±0.1pF	GRM1554C1HR40BA01#
				±5%	GRM1555C1H120JA01#					0.50pF	±0.05pF	GRM1554C1HR50WA01#
			15pF	±2%	GRM1555C1H150GA01#						±0.1pF	GRM1554C1HR50BA01#
				±5%	GRM1555C1H150JA01#					0.60pF	±0.05pF	GRM1554C1HR60WA01#
			18pF	±2%	GRM1555C1H180GA01#						±0.1pF	GRM1554C1HR60BA01#
				±5%	GRM1555C1H180JA01#					0.70pF	±0.05pF	GRM1554C1HR70WA01#
			22pF	±2%	GRM1555C1H220GA01#						±0.1pF	GRM1554C1HR70BA01#
				±5%	GRM1555C1H220JA01#					0.80pF	±0.05pF	GRM1554C1HR80WA01#
			27pF	±2%	GRM1555C1H270GA01#						±0.1pF	GRM1554C1HR80BA01#
				±5%	GRM1555C1H270JA01#					0.90pF	±0.05pF	GRM1554C1HR90WA01#
			33pF	±2%	GRM1555C1H330GA01#						±0.1pF	GRM1554C1HR90BA01#
				±5%	GRM1555C1H330JA01#					1.0pF	±0.05pF	GRM1554C1H1R0WA01#
			39pF	±2%	GRM1555C1H390GA01#						±0.1pF	GRM1554C1H1R0BA01#
				±5%	GRM1555C1H390JA01#						±0.25pF	GRM1554C1H1R0CA01#
			47pF	±2%	GRM1555C1H470GA01#					1.1pF	±0.05pF	GRM1554C1H1R1WA01#
				±5%	GRM1555C1H470JA01#						±0.1pF	GRM1554C1H1R1BA01#
				56pF	±2%						GRM1555C1H560GA01#	±0.25pF
			±5%		GRM1555C1H560JA01#					1.2pF	±0.05pF	GRM1554C1H1R2WA01#
			68pF		±2%						GRM1555C1H680GA01#	±0.1pF
				±5%	GRM1555C1H680JA01#						±0.25pF	GRM1554C1H1R2CA01#
			82pF	±2%	GRM1555C1H820GA01#					1.3pF	±0.05pF	GRM1554C1H1R3WA01#
				±5%	GRM1555C1H820JA01#						±0.1pF	GRM1554C1H1R3BA01#
			100pF	±2%	GRM1555C1H101GA01#						±0.25pF	GRM1554C1H1R3CA01#
				±5%	GRM1555C1H101JA01#					1.4pF	±0.05pF	GRM1554C1H1R4WA01#
			120pF	±2%	GRM1555C1H121GA01#						±0.1pF	GRM1554C1H1R4BA01#
±5%	GRM1555C1H121JA01#	±0.25pF		GRM1554C1H1R4CA01#								
150pF	±2%	GRM1555C1H151GA01#	1.5pF	±0.05pF	GRM1554C1H1R5WA01#							
	±5%	GRM1555C1H151JA01#		±0.1pF	GRM1554C1H1R5BA01#							
180pF	±2%	GRM1555C1H181GA01#		±0.25pF	GRM1554C1H1R5CA01#							
	±5%	GRM1555C1H181JA01#	1.6pF	±0.05pF	GRM1554C1H1R6WA01#							
220pF	±2%	GRM1555C1H221GA01#		±0.1pF	GRM1554C1H1R6BA01#							
	±5%	GRM1555C1H221JA01#		±0.25pF	GRM1554C1H1R6CA01#							
270pF	±2%	GRM1555C1H271GA01#	1.7pF	±0.05pF	GRM1554C1H1R7WA01#							
	±5%	GRM1555C1H271JA01#		±0.1pF	GRM1554C1H1R7BA01#							
330pF	±2%	GRM1555C1H331GA01#		±0.25pF	GRM1554C1H1R7CA01#							
	±5%	GRM1555C1H331JA01#	1.8pF	±0.05pF	GRM1554C1H1R8WA01#							
390pF	±2%	GRM1555C1H391GA01#		±0.1pF	GRM1554C1H1R8BA01#							

Part number # indicates the package specification code.



GRM Series Temperature Compensating Type Part Number List

(→ 1.0×0.5mm)

T max.	Rated Voltage	TC Code	Cap.	Tol.	Part Number	T max.	Rated Voltage	TC Code	Cap.	Tol.	Part Number	
0.55mm	50Vdc	CK	1.8pF	±0.25pF	GRM1554C1H1R8CA01#	0.55mm	50Vdc	CJ	3.6pF	±0.25pF	GRM1553C1H3R6CA01#	
				±0.05pF	GRM1554C1H1R9WA01#					3.7pF	±0.05pF	GRM1553C1H3R7WA01#
				±0.1pF	GRM1554C1H1R9BA01#						±0.1pF	GRM1553C1H3R7BA01#
			±0.25pF	GRM1554C1H1R9CA01#	±0.25pF				GRM1553C1H3R7CA01#			
			2.0pF	±0.05pF	GRM1554C1H2R0WA01#				3.8pF	±0.05pF	GRM1553C1H3R8WA01#	
				±0.1pF	GRM1554C1H2R0BA01#					±0.1pF	GRM1553C1H3R8BA01#	
				±0.25pF	GRM1554C1H2R0CA01#					±0.25pF	GRM1553C1H3R8CA01#	
			2.1pF	±0.05pF	GRM1553C1H2R1WA01#				3.9pF	±0.05pF	GRM1553C1H3R9WA01#	
				±0.1pF	GRM1553C1H2R1BA01#					±0.1pF	GRM1553C1H3R9BA01#	
				±0.25pF	GRM1553C1H2R1CA01#					±0.25pF	GRM1553C1H3R9CA01#	
			2.2pF	±0.05pF	GRM1553C1H2R2WA01#				4.0pF	±0.05pF	GRM1552C1H4R0WA01#	
				±0.1pF	GRM1553C1H2R2BA01#					±0.1pF	GRM1552C1H4R0BA01#	
				±0.25pF	GRM1553C1H2R2CA01#					±0.25pF	GRM1552C1H4R0CA01#	
			2.3pF	±0.05pF	GRM1553C1H2R3WA01#				4.1pF	±0.05pF	GRM1552C1H4R1WA01#	
				±0.1pF	GRM1553C1H2R3BA01#					±0.1pF	GRM1552C1H4R1BA01#	
				±0.25pF	GRM1553C1H2R3CA01#					±0.25pF	GRM1552C1H4R1CA01#	
			2.4pF	±0.05pF	GRM1553C1H2R4WA01#				4.2pF	±0.05pF	GRM1552C1H4R2WA01#	
				±0.1pF	GRM1553C1H2R4BA01#					±0.1pF	GRM1552C1H4R2BA01#	
				±0.25pF	GRM1553C1H2R4CA01#					±0.25pF	GRM1552C1H4R2CA01#	
			2.5pF	±0.05pF	GRM1553C1H2R5WA01#				4.3pF	±0.05pF	GRM1552C1H4R3WA01#	
				±0.1pF	GRM1553C1H2R5BA01#					±0.1pF	GRM1552C1H4R3BA01#	
				±0.25pF	GRM1553C1H2R5CA01#					±0.25pF	GRM1552C1H4R3CA01#	
			2.6pF	±0.05pF	GRM1553C1H2R6WA01#				4.4pF	±0.05pF	GRM1552C1H4R4WA01#	
				±0.1pF	GRM1553C1H2R6BA01#					±0.1pF	GRM1552C1H4R4BA01#	
				±0.25pF	GRM1553C1H2R6CA01#					±0.25pF	GRM1552C1H4R4CA01#	
			2.7pF	±0.05pF	GRM1553C1H2R7WA01#				4.5pF	±0.05pF	GRM1552C1H4R5WA01#	
				±0.1pF	GRM1553C1H2R7BA01#					±0.1pF	GRM1552C1H4R5BA01#	
				±0.25pF	GRM1553C1H2R7CA01#					±0.25pF	GRM1552C1H4R5CA01#	
			2.8pF	±0.05pF	GRM1553C1H2R8WA01#				4.6pF	±0.05pF	GRM1552C1H4R6WA01#	
				±0.1pF	GRM1553C1H2R8BA01#					±0.1pF	GRM1552C1H4R6BA01#	
		±0.25pF		GRM1553C1H2R8CA01#	±0.25pF	GRM1552C1H4R6CA01#						
		2.9pF	±0.05pF	GRM1553C1H2R9WA01#	4.7pF	±0.05pF		GRM1552C1H4R7WA01#				
			±0.1pF	GRM1553C1H2R9BA01#		±0.1pF		GRM1552C1H4R7BA01#				
			±0.25pF	GRM1553C1H2R9CA01#		±0.25pF		GRM1552C1H4R7CA01#				
		3.0pF	±0.05pF	GRM1553C1H3R0WA01#	4.8pF	±0.05pF		GRM1552C1H4R8WA01#				
			±0.1pF	GRM1553C1H3R0BA01#		±0.1pF		GRM1552C1H4R8BA01#				
			±0.25pF	GRM1553C1H3R0CA01#		±0.25pF		GRM1552C1H4R8CA01#				
		3.1pF	±0.05pF	GRM1553C1H3R1WA01#	4.9pF	±0.05pF		GRM1552C1H4R9WA01#				
			±0.1pF	GRM1553C1H3R1BA01#		±0.1pF		GRM1552C1H4R9BA01#				
			±0.25pF	GRM1553C1H3R1CA01#		±0.25pF		GRM1552C1H4R9CA01#				
		3.2pF	±0.05pF	GRM1553C1H3R2WA01#	5.0pF	±0.05pF		GRM1552C1H5R0WA01#				
			±0.1pF	GRM1553C1H3R2BA01#		±0.1pF		GRM1552C1H5R0BA01#				
			±0.25pF	GRM1553C1H3R2CA01#		±0.25pF		GRM1552C1H5R0CA01#				
		3.3pF	±0.05pF	GRM1553C1H3R3WA01#	5.1pF	±0.05pF		GRM1552C1H5R1WA01#				
			±0.1pF	GRM1553C1H3R3BA01#		±0.1pF		GRM1552C1H5R1BA01#				
			±0.25pF	GRM1553C1H3R3CA01#		±0.25pF		GRM1552C1H5R1CA01#				
		3.4pF	±0.05pF	GRM1553C1H3R4WA01#	5.2pF	±0.05pF		GRM1552C1H5R2WA01#				
			±0.1pF	GRM1553C1H3R4BA01#		±0.1pF		GRM1552C1H5R2BA01#				
			±0.25pF	GRM1553C1H3R4CA01#		±0.25pF		GRM1552C1H5R2CA01#				
		3.5pF	±0.05pF	GRM1553C1H3R5WA01#	5.3pF	±0.05pF		GRM1552C1H5R3WA01#				
			±0.1pF	GRM1553C1H3R5BA01#		±0.1pF		GRM1552C1H5R3BA01#				
			±0.25pF	GRM1553C1H3R5CA01#		±0.25pF		GRM1552C1H5R3CA01#				
		3.6pF	±0.05pF	GRM1553C1H3R6WA01#	5.3pF	±0.05pF		GRM1552C1H5R3WA01#				
			±0.1pF	GRM1553C1H3R6BA01#		±0.1pF		GRM1552C1H5R3BA01#				

- GRM
- GR3
- GRJ
- GR4
- GR7
- GJM
- GJM
- GQM
- GA2
- GA3 GB
- GA3 GD
- GA3 GF
- LLL
- LLA
- LLM
- LLR
- NFM
- KRM
- KR3
- GMA
- GMD
- ⚠Caution /Notice

Part number # indicates the package specification code.

GRM Series Temperature Compensating Type Part Number List

(→ 1.0×0.5mm)

T max.	Rated Voltage	TC Code	Cap.	Tol.	Part Number	T max.	Rated Voltage	TC Code	Cap.	Tol.	Part Number		
0.55mm	50Vdc	CH	5.3pF	±0.5pF	GRM1552C1H5R3DA01#	0.55mm	50Vdc	CH	6.7pF	±0.1pF	GRM1552C1H6R7BA01#		
				±0.05pF	GRM1552C1H5R4WA01#					±0.25pF	GRM1552C1H6R7CA01#		
				±0.1pF	GRM1552C1H5R4BA01#					±0.5pF	GRM1552C1H6R7DA01#		
			5.4pF	±0.25pF	GRM1552C1H5R4CA01#				6.8pF	±0.05pF	GRM1552C1H6R8WA01#		
				±0.5pF	GRM1552C1H5R4DA01#					±0.1pF	GRM1552C1H6R8BA01#		
				±0.05pF	GRM1552C1H5R5WA01#					±0.25pF	GRM1552C1H6R8CA01#		
			5.5pF	±0.1pF	GRM1552C1H5R5BA01#				±0.5pF	GRM1552C1H6R8DA01#	6.9pF	±0.05pF	GRM1552C1H6R9WA01#
				±0.25pF	GRM1552C1H5R5CA01#				±0.1pF	GRM1552C1H6R9BA01#		±0.25pF	GRM1552C1H6R9CA01#
				±0.5pF	GRM1552C1H5R5DA01#				±0.5pF	GRM1552C1H6R9DA01#			
			5.6pF	±0.05pF	GRM1552C1H5R6WA01#				7.0pF	±0.05pF	GRM1552C1H7R0WA01#		
				±0.1pF	GRM1552C1H5R6BA01#					±0.1pF	GRM1552C1H7R0BA01#		
				±0.25pF	GRM1552C1H5R6CA01#					±0.25pF	GRM1552C1H7R0CA01#		
			5.7pF	±0.5pF	GRM1552C1H5R6DA01#				±0.5pF	GRM1552C1H7R0DA01#	7.1pF	±0.05pF	GRM1552C1H7R1WA01#
				±0.05pF	GRM1552C1H5R7WA01#				±0.1pF	GRM1552C1H7R1BA01#		±0.25pF	GRM1552C1H7R1CA01#
				±0.1pF	GRM1552C1H5R7BA01#				±0.5pF	GRM1552C1H7R1DA01#			
			5.8pF	±0.25pF	GRM1552C1H5R7CA01#				7.2pF	±0.05pF	GRM1552C1H7R2WA01#		
				±0.5pF	GRM1552C1H5R7DA01#					±0.1pF	GRM1552C1H7R2BA01#		
				±0.05pF	GRM1552C1H5R8WA01#					±0.25pF	GRM1552C1H7R2CA01#		
			5.9pF	±0.1pF	GRM1552C1H5R8BA01#				±0.5pF	GRM1552C1H7R2DA01#	7.3pF	±0.05pF	GRM1552C1H7R3WA01#
				±0.25pF	GRM1552C1H5R8CA01#				±0.1pF	GRM1552C1H7R3BA01#		±0.25pF	GRM1552C1H7R3CA01#
				±0.5pF	GRM1552C1H5R8DA01#				±0.5pF	GRM1552C1H7R3DA01#			
			6.0pF	±0.05pF	GRM1552C1H5R9WA01#				7.4pF	±0.05pF	GRM1552C1H7R4WA01#		
				±0.1pF	GRM1552C1H5R9BA01#					±0.1pF	GRM1552C1H7R4BA01#		
				±0.25pF	GRM1552C1H5R9CA01#					±0.25pF	GRM1552C1H7R4CA01#		
			6.1pF	±0.5pF	GRM1552C1H5R9DA01#				±0.5pF	GRM1552C1H7R4DA01#	7.5pF	±0.05pF	GRM1552C1H7R5WA01#
				±0.05pF	GRM1552C1H6R0WA01#				±0.1pF	GRM1552C1H7R5BA01#		±0.25pF	GRM1552C1H7R5CA01#
				±0.1pF	GRM1552C1H6R0BA01#				±0.5pF	GRM1552C1H7R5DA01#			
			6.2pF	±0.25pF	GRM1552C1H6R0CA01#				7.6pF	±0.05pF	GRM1552C1H7R6WA01#		
				±0.5pF	GRM1552C1H6R0DA01#					±0.1pF	GRM1552C1H7R6BA01#		
				±0.05pF	GRM1552C1H6R1WA01#					±0.25pF	GRM1552C1H7R6CA01#		
			6.3pF	±0.1pF	GRM1552C1H6R1BA01#				±0.5pF	GRM1552C1H7R6DA01#	7.7pF	±0.05pF	GRM1552C1H7R7WA01#
				±0.25pF	GRM1552C1H6R1CA01#				±0.1pF	GRM1552C1H7R7BA01#		±0.25pF	GRM1552C1H7R7CA01#
				±0.5pF	GRM1552C1H6R1DA01#				±0.5pF	GRM1552C1H7R7DA01#			
			6.4pF	±0.05pF	GRM1552C1H6R2WA01#				7.8pF	±0.05pF	GRM1552C1H7R8WA01#		
				±0.1pF	GRM1552C1H6R2BA01#					±0.1pF	GRM1552C1H7R8BA01#		
				±0.25pF	GRM1552C1H6R2CA01#					±0.25pF	GRM1552C1H7R8CA01#		
			6.5pF	±0.5pF	GRM1552C1H6R2DA01#				±0.5pF	GRM1552C1H7R8DA01#	7.9pF	±0.05pF	GRM1552C1H7R9WA01#
				±0.05pF	GRM1552C1H6R3WA01#				±0.1pF	GRM1552C1H7R9BA01#		±0.25pF	GRM1552C1H7R9CA01#
				±0.1pF	GRM1552C1H6R3BA01#				±0.5pF	GRM1552C1H7R9DA01#			
			6.6pF	±0.25pF	GRM1552C1H6R3CA01#				8.0pF	±0.05pF	GRM1552C1H8R0WA01#		
				±0.5pF	GRM1552C1H6R3DA01#					±0.1pF	GRM1552C1H8R0BA01#		
				±0.05pF	GRM1552C1H6R4WA01#					±0.25pF	GRM1552C1H8R0CA01#		
			6.7pF	±0.1pF	GRM1552C1H6R4BA01#				±0.5pF	GRM1552C1H8R0DA01#		±0.05pF	GRM1552C1H8R0WA01#
				±0.25pF	GRM1552C1H6R4CA01#				±0.1pF	GRM1552C1H8R0BA01#		±0.25pF	GRM1552C1H8R0CA01#
				±0.5pF	GRM1552C1H6R4DA01#				±0.5pF	GRM1552C1H8R0DA01#			

Part number # indicates the package specification code.



GRM Series Temperature Compensating Type Part Number List

(→ 1.0×0.5mm)

T max.	Rated Voltage	TC Code	Cap.	Tol.	Part Number	T max.	Rated Voltage	TC Code	Cap.	Tol.	Part Number
0.55mm	50Vdc	CH	8.0pF	±0.5pF	GRM1552C1H8R0DA01#	0.55mm	50Vdc	CH	9.4pF	±0.1pF	GRM1552C1H9R4BA01#
				±0.05pF	GRM1552C1H8R1WA01#					±0.25pF	GRM1552C1H9R4CA01#
				±0.1pF	GRM1552C1H8R1BA01#					±0.5pF	GRM1552C1H9R4DA01#
			8.1pF	±0.25pF	GRM1552C1H8R1CA01#	9.5pF			±0.05pF	GRM1552C1H9R5WA01#	
				±0.5pF	GRM1552C1H8R1DA01#				±0.1pF	GRM1552C1H9R5BA01#	
				8.2pF	±0.05pF				GRM1552C1H8R2WA01#	±0.25pF	GRM1552C1H9R5CA01#
					±0.1pF				GRM1552C1H8R2BA01#	±0.5pF	GRM1552C1H9R5DA01#
			±0.25pF		GRM1552C1H8R2CA01#	9.6pF			±0.05pF	GRM1552C1H9R6WA01#	
			±0.5pF	GRM1552C1H8R2DA01#	±0.1pF				GRM1552C1H9R6BA01#		
			8.3pF	±0.05pF	GRM1552C1H8R3WA01#				±0.25pF	GRM1552C1H9R6CA01#	
				±0.1pF	GRM1552C1H8R3BA01#	±0.5pF			GRM1552C1H9R6DA01#		
				±0.25pF	GRM1552C1H8R3CA01#	9.7pF			±0.05pF	GRM1552C1H9R7WA01#	
			±0.5pF	GRM1552C1H8R3DA01#	±0.1pF				GRM1552C1H9R7BA01#		
			8.4pF	±0.05pF	GRM1552C1H8R4WA01#				±0.25pF	GRM1552C1H9R7CA01#	
				±0.1pF	GRM1552C1H8R4BA01#	±0.5pF			GRM1552C1H9R7DA01#		
				±0.25pF	GRM1552C1H8R4CA01#	9.8pF			±0.05pF	GRM1552C1H9R8WA01#	
				±0.5pF	GRM1552C1H8R4DA01#				±0.1pF	GRM1552C1H9R8BA01#	
			8.5pF	±0.05pF	GRM1552C1H8R5WA01#				±0.25pF	GRM1552C1H9R8CA01#	
				±0.1pF	GRM1552C1H8R5BA01#	±0.5pF			GRM1552C1H9R8DA01#		
				±0.25pF	GRM1552C1H8R5CA01#	9.9pF			±0.05pF	GRM1552C1H9R9WA01#	
			±0.5pF	GRM1552C1H8R5DA01#	±0.1pF				GRM1552C1H9R9BA01#		
			8.6pF	±0.05pF	GRM1552C1H8R6WA01#				±0.25pF	GRM1552C1H9R9CA01#	
				±0.1pF	GRM1552C1H8R6BA01#	±0.5pF			GRM1552C1H9R9DA01#		
				±0.25pF	GRM1552C1H8R6CA01#	10pF			±2%	GRM1552C1H100GA01#	
				±0.5pF	GRM1552C1H8R6DA01#				±5%	GRM1552C1H100JA01#	
			8.7pF	±0.05pF	GRM1552C1H8R7WA01#	12pF			±2%	GRM1552C1H120GA01#	
				±0.1pF	GRM1552C1H8R7BA01#				±5%	GRM1552C1H120JA01#	
				±0.25pF	GRM1552C1H8R7CA01#	15pF			±2%	GRM1552C1H150GA01#	
				±0.5pF	GRM1552C1H8R7DA01#				±5%	GRM1552C1H150JA01#	
			8.8pF	±0.05pF	GRM1552C1H8R8WA01#	18pF			±2%	GRM1552C1H180GA01#	
				±0.1pF	GRM1552C1H8R8BA01#				±5%	GRM1552C1H180JA01#	
				±0.25pF	GRM1552C1H8R8CA01#	22pF			±2%	GRM1552C1H220GA01#	
				±0.5pF	GRM1552C1H8R8DA01#				±5%	GRM1552C1H220JA01#	
			8.9pF	±0.05pF	GRM1552C1H8R9WA01#	27pF			±2%	GRM1552C1H270GA01#	
				±0.1pF	GRM1552C1H8R9BA01#				±5%	GRM1552C1H270JA01#	
				±0.25pF	GRM1552C1H8R9CA01#	33pF			±2%	GRM1552C1H330GA01#	
				±0.5pF	GRM1552C1H8R9DA01#				±5%	GRM1552C1H330JA01#	
			9.0pF	±0.05pF	GRM1552C1H9R0WA01#	39pF			±2%	GRM1552C1H390GA01#	
				±0.1pF	GRM1552C1H9R0BA01#				±5%	GRM1552C1H390JA01#	
				±0.25pF	GRM1552C1H9R0CA01#	47pF			±2%	GRM1552C1H470GA01#	
				±0.5pF	GRM1552C1H9R0DA01#				±5%	GRM1552C1H470JA01#	
			9.1pF	±0.05pF	GRM1552C1H9R1WA01#	56pF			±2%	GRM1552C1H560GA01#	
				±0.1pF	GRM1552C1H9R1BA01#				±5%	GRM1552C1H560JA01#	
				±0.25pF	GRM1552C1H9R1CA01#	68pF			±2%	GRM1552C1H680GA01#	
				±0.5pF	GRM1552C1H9R1DA01#				±5%	GRM1552C1H680JA01#	
			9.2pF	±0.05pF	GRM1552C1H9R2WA01#	82pF			±2%	GRM1552C1H820GA01#	
				±0.1pF	GRM1552C1H9R2BA01#				±5%	GRM1552C1H820JA01#	
				±0.25pF	GRM1552C1H9R2CA01#	100pF			±2%	GRM1552C1H101GA01#	
				±0.5pF	GRM1552C1H9R2DA01#				±5%	GRM1552C1H101JA01#	
			9.3pF	±0.05pF	GRM1552C1H9R3WA01#	120pF			±2%	GRM1552C1H121GA01#	
				±0.1pF	GRM1552C1H9R3BA01#				±5%	GRM1552C1H121JA01#	
				±0.25pF	GRM1552C1H9R3CA01#	150pF			±2%	GRM1552C1H151GA01#	
				±0.5pF	GRM1552C1H9R3DA01#				±5%	GRM1552C1H151JA01#	
			9.4pF	±0.05pF	GRM1552C1H9R4WA01#	180pF			±2%	GRM1552C1H181GA01#	

- GRM
- GR3
- GRJ
- GR4
- GR7
- GJM
- GQM
- GA2
- GA3 GB
- GA3 GD
- GA3 GF
- LLL
- LLA
- LLM
- LLR
- NFM
- KRM
- KR3
- GMA
- GMD
- ⚠Caution /Notice

Part number # indicates the package specification code.

GRM Series Temperature Compensating Type Part Number List

(→ 1.0×0.5mm)

T max.	Rated Voltage	TC Code	Cap.	Tol.	Part Number	
0.55mm	50Vdc	CH	180pF	±5%	GRM1552C1H181JA01#	
				±2%	GRM1552C1H221GA01#	
			±5%	GRM1552C1H221JA01#		
			270pF	±2%	GRM1552C1H271GA01#	
				±5%	GRM1552C1H271JA01#	
			330pF	±2%	GRM1552C1H331GA01#	
				±5%	GRM1552C1H331JA01#	
			390pF	±2%	GRM1552C1H391GA01#	
				±5%	GRM1552C1H391JA01#	
			470pF	±2%	GRM1552C1H471GA01#	
				±5%	GRM1552C1H471JA01#	
			560pF	±2%	GRM1552C1H561GA01#	
				±5%	GRM1552C1H561JA01#	
			680pF	±2%	GRM1552C1H681GA01#	
				±5%	GRM1552C1H681JA01#	
			820pF	±2%	GRM1552C1H821GA01#	
				±5%	GRM1552C1H821JA01#	
			1000pF	±2%	GRM1552C1H102GA01#	
				±5%	GRM1552C1H102JA01#	
			10Vdc	SL	1200pF	±5%
	±5%	GRM1551X1A152JA01#				
	1800pF	±5%			GRM1551X1A182JA01#	
		±5%			GRM1551X1A222JA01#	
	2700pF	±5%			GRM1551X1A272JA01#	
		±5%			GRM1551X1A332JA01#	
	3900pF	±5%			GRM1551X1A392JA01#	
		±5%			GRM1551X1A472JA01#	
	U2J	1200pF			±5%	GRM1557U1A122JA01#
					±5%	GRM1557U1A152JA01#
		1800pF			±5%	GRM1557U1A182JA01#
					±5%	GRM1557U1A222JA01#
		2700pF			±5%	GRM1557U1A272JA01#
					±5%	GRM1557U1A332JA01#
		3900pF			±5%	GRM1557U1A392JA01#
					±5%	GRM1557U1A472JA01#
	UJ	1200pF			±5%	GRM1553U1A122JA01#
					±5%	GRM1553U1A152JA01#
		1800pF			±5%	GRM1553U1A182JA01#
					±5%	GRM1553U1A222JA01#
		2700pF		±5%	GRM1553U1A272JA01#	
±5%				GRM1553U1A332JA01#		
3900pF		±5%		GRM1553U1A392JA01#		
		±5%		GRM1553U1A472JA01#		

T max.	Rated Voltage	TC Code	Cap.	Tol.	Part Number		
0.5mm	50Vdc	U2J	2700pF	±5%	GRM1857U1H272JA44#		
				±5%	GRM1857U1H332JA44#		
			3900pF	±5%	GRM1857U1H392JA44#		
				±5%	GRM1857U1H472JA44#		
			UJ	2200pF	±5%	GRM1853U1H222JA44#	
					±5%	GRM1853U1H272JA44#	
				3300pF	±5%	GRM1853U1H332JA44#	
					±5%	GRM1853U1H392JA44#	
			10Vdc	SL	5600pF	±5%	GRM1851X1A562JA44#
						±5%	GRM1851X1A682JA44#
		8200pF			±5%	GRM1851X1A822JA44#	
					±5%	GRM1851X1A103JA44#	
		U2J	5600pF	±5%	GRM1857U1A562JA44#		
				±5%	GRM1857U1A682JA44#		
			8200pF	±5%	GRM1857U1A822JA44#		
				±5%	GRM1857U1A103JA44#		
			UJ	5600pF	±5%	GRM1853U1A562JA44#	
					±5%	GRM1853U1A682JA44#	
				8200pF	±5%	GRM1853U1A822JA44#	
					±5%	GRM1853U1A103JA44#	
	0.9mm	100Vdc	COG	0.50pF	±0.05pF	GRM1885C2AR50WA01#	
					±0.1pF	GRM1885C2AR50BA01#	
				0.60pF	±0.05pF	GRM1885C2AR60WA01#	
					±0.1pF	GRM1885C2AR60BA01#	
				0.70pF	±0.05pF	GRM1885C2AR70WA01#	
					±0.1pF	GRM1885C2AR70BA01#	
				0.80pF	±0.05pF	GRM1885C2AR80WA01#	
					±0.1pF	GRM1885C2AR80BA01#	
				0.90pF	±0.05pF	GRM1885C2AR90WA01#	
					±0.1pF	GRM1885C2AR90BA01#	
				1.0pF	±0.05pF	GRM1885C2A1R0WA01#	
						±0.1pF	GRM1885C2A1R0BA01#
					±0.25pF	GRM1885C2A1R0CA01#	
						GRM1885C2A1R1WA01#	
				1.1pF	±0.05pF	GRM1885C2A1R1BA01#	
						±0.1pF	GRM1885C2A1R1CA01#
					±0.25pF	GRM1885C2A1R2WA01#	
						±0.1pF	GRM1885C2A1R2BA01#
				1.2pF	±0.05pF	GRM1885C2A1R2CA01#	
						±0.1pF	GRM1885C2A1R3WA01#
±0.25pF					GRM1885C2A1R3BA01#		
					±0.1pF	GRM1885C2A1R3CA01#	
1.3pF				±0.05pF	GRM1885C2A1R4WA01#		
					±0.1pF	GRM1885C2A1R4BA01#	
				±0.25pF	GRM1885C2A1R4CA01#		
					±0.05pF	GRM1885C2A1R5WA01#	
1.4pF				±0.05pF	GRM1885C2A1R5BA01#		
					±0.1pF	GRM1885C2A1R5CA01#	
				±0.25pF	GRM1885C2A1R6WA01#		
					±0.05pF	GRM1885C2A1R6BA01#	
1.5pF				±0.05pF	GRM1885C2A1R6CA01#		
					±0.1pF	GRM1885C2A1R7WA01#	
				±0.25pF	GRM1885C2A1R7BA01#		
					±0.05pF	GRM1885C2A1R7CA01#	

1.6×0.8mm

T max.	Rated Voltage	TC Code	Cap.	Tol.	Part Number
0.5mm	50Vdc	SL	2200pF	±5%	GRM1851X1H222JA44#
				±5%	GRM1851X1H272JA44#
			3300pF	±5%	GRM1851X1H332JA44#
				±5%	GRM1851X1H392JA44#
			4700pF	±5%	GRM1851X1H472JA44#
		U2J		2200pF	±5%

Part number # indicates the package specification code.

GRM Series Temperature Compensating Type Part Number List

(→ 1.6×0.8mm)

T max.	Rated Voltage	TC Code	Cap.	Tol.	Part Number	T max.	Rated Voltage	TC Code	Cap.	Tol.	Part Number		
0.9mm	100Vdc	COG	1.7pF	±0.25pF	GRM1885C2A1R7CA01#	0.9mm	100Vdc	COG	3.5pF	±0.25pF	GRM1885C2A3R5CA01#		
				1.8pF	±0.05pF					GRM1885C2A1R8WA01#	3.6pF	±0.05pF	GRM1885C2A3R6WA01#
					±0.1pF					GRM1885C2A1R8BA01#		±0.1pF	GRM1885C2A3R6BA01#
			±0.25pF		GRM1885C2A1R8CA01#				±0.25pF	GRM1885C2A3R6CA01#			
			1.9pF	±0.05pF	GRM1885C2A1R9WA01#				3.7pF	±0.05pF	GRM1885C2A3R7WA01#		
				±0.1pF	GRM1885C2A1R9BA01#					±0.1pF	GRM1885C2A3R7BA01#		
				±0.25pF	GRM1885C2A1R9CA01#					±0.25pF	GRM1885C2A3R7CA01#		
			2.0pF	±0.05pF	GRM1885C2A2R0WA01#				3.8pF	±0.05pF	GRM1885C2A3R8WA01#		
				±0.1pF	GRM1885C2A2R0BA01#					±0.1pF	GRM1885C2A3R8BA01#		
				±0.25pF	GRM1885C2A2R0CA01#					±0.25pF	GRM1885C2A3R8CA01#		
			2.1pF	±0.05pF	GRM1885C2A2R1WA01#				3.9pF	±0.05pF	GRM1885C2A3R9WA01#		
				±0.1pF	GRM1885C2A2R1BA01#					±0.1pF	GRM1885C2A3R9BA01#		
				±0.25pF	GRM1885C2A2R1CA01#					±0.25pF	GRM1885C2A3R9CA01#		
			2.2pF	±0.05pF	GRM1885C2A2R2WA01#				4.0pF	±0.05pF	GRM1885C2A4R0WA01#		
				±0.1pF	GRM1885C2A2R2BA01#					±0.1pF	GRM1885C2A4R0BA01#		
				±0.25pF	GRM1885C2A2R2CA01#					±0.25pF	GRM1885C2A4R0CA01#		
			2.3pF	±0.05pF	GRM1885C2A2R3WA01#				4.1pF	±0.05pF	GRM1885C2A4R1WA01#		
				±0.1pF	GRM1885C2A2R3BA01#					±0.1pF	GRM1885C2A4R1BA01#		
				±0.25pF	GRM1885C2A2R3CA01#					±0.25pF	GRM1885C2A4R1CA01#		
			2.4pF	±0.05pF	GRM1885C2A2R4WA01#				4.2pF	±0.05pF	GRM1885C2A4R2WA01#		
				±0.1pF	GRM1885C2A2R4BA01#					±0.1pF	GRM1885C2A4R2BA01#		
				±0.25pF	GRM1885C2A2R4CA01#					±0.25pF	GRM1885C2A4R2CA01#		
			2.5pF	±0.05pF	GRM1885C2A2R5WA01#				4.3pF	±0.05pF	GRM1885C2A4R3WA01#		
				±0.1pF	GRM1885C2A2R5BA01#					±0.1pF	GRM1885C2A4R3BA01#		
				±0.25pF	GRM1885C2A2R5CA01#					±0.25pF	GRM1885C2A4R3CA01#		
			2.6pF	±0.05pF	GRM1885C2A2R6WA01#				4.4pF	±0.05pF	GRM1885C2A4R4WA01#		
				±0.1pF	GRM1885C2A2R6BA01#					±0.1pF	GRM1885C2A4R4BA01#		
				±0.25pF	GRM1885C2A2R6CA01#					±0.25pF	GRM1885C2A4R4CA01#		
			2.7pF	±0.05pF	GRM1885C2A2R7WA01#				4.5pF	±0.05pF	GRM1885C2A4R5WA01#		
				±0.1pF	GRM1885C2A2R7BA01#					±0.1pF	GRM1885C2A4R5BA01#		
				±0.25pF	GRM1885C2A2R7CA01#					±0.25pF	GRM1885C2A4R5CA01#		
			2.8pF	±0.05pF	GRM1885C2A2R8WA01#				4.6pF	±0.05pF	GRM1885C2A4R6WA01#		
				±0.1pF	GRM1885C2A2R8BA01#					±0.1pF	GRM1885C2A4R6BA01#		
				±0.25pF	GRM1885C2A2R8CA01#					±0.25pF	GRM1885C2A4R6CA01#		
			2.9pF	±0.05pF	GRM1885C2A2R9WA01#				4.7pF	±0.05pF	GRM1885C2A4R7WA01#		
				±0.1pF	GRM1885C2A2R9BA01#					±0.1pF	GRM1885C2A4R7BA01#		
				±0.25pF	GRM1885C2A2R9CA01#					±0.25pF	GRM1885C2A4R7CA01#		
			3.0pF	±0.05pF	GRM1885C2A3R0WA01#				4.8pF	±0.05pF	GRM1885C2A4R8WA01#		
				±0.1pF	GRM1885C2A3R0BA01#					±0.1pF	GRM1885C2A4R8BA01#		
				±0.25pF	GRM1885C2A3R0CA01#					±0.25pF	GRM1885C2A4R8CA01#		
			3.1pF	±0.05pF	GRM1885C2A3R1WA01#				4.9pF	±0.05pF	GRM1885C2A4R9WA01#		
				±0.1pF	GRM1885C2A3R1BA01#					±0.1pF	GRM1885C2A4R9BA01#		
				±0.25pF	GRM1885C2A3R1CA01#					±0.25pF	GRM1885C2A4R9CA01#		
			3.2pF	±0.05pF	GRM1885C2A3R2WA01#				5.0pF	±0.05pF	GRM1885C2A5R0WA01#		
				±0.1pF	GRM1885C2A3R2BA01#					±0.1pF	GRM1885C2A5R0BA01#		
				±0.25pF	GRM1885C2A3R2CA01#					±0.25pF	GRM1885C2A5R0CA01#		
			3.3pF	±0.05pF	GRM1885C2A3R3WA01#				5.1pF	±0.05pF	GRM1885C2A5R1WA01#		
				±0.1pF	GRM1885C2A3R3BA01#					±0.1pF	GRM1885C2A5R1BA01#		
				±0.25pF	GRM1885C2A3R3CA01#					±0.25pF	GRM1885C2A5R1CA01#		
			3.4pF	±0.05pF	GRM1885C2A3R4WA01#				5.2pF	±0.05pF	GRM1885C2A5R2WA01#		
				±0.1pF	GRM1885C2A3R4BA01#					±0.1pF	GRM1885C2A5R2BA01#		
				±0.25pF	GRM1885C2A3R4CA01#					±0.25pF	GRM1885C2A5R2CA01#		
			3.5pF	±0.05pF	GRM1885C2A3R5WA01#				5.2pF	±0.05pF	GRM1885C2A5R2WA01#		
				±0.1pF	GRM1885C2A3R5BA01#					±0.1pF	GRM1885C2A5R2BA01#		
									±0.5pF		GRM1885C2A5R2DA01#		

GRM
 GR3
 GRJ
 GR4
 GR7
 GJM
 GQM
 GA2
 GA3 GB
 GA3 GD
 GA3 GF
 LLL
 LLA
 LLM
 LLR
 NFM
 KRM
 KR3
 GMA
 GMD
 ⚠Caution /Notice

Part number # indicates the package specification code.

GRM Series Temperature Compensating Type Part Number List

(→ 1.6×0.8mm)

T max.	Rated Voltage	TC Code	Cap.	Tol.	Part Number	T max.	Rated Voltage	TC Code	Cap.	Tol.	Part Number	
0.9mm	100Vdc	COG	5.3pF	±0.05pF	GRM1885C2A5R3WA01#	0.9mm	100Vdc	COG	6.6pF	±0.25pF	GRM1885C2A6R6CA01#	
				±0.1pF	GRM1885C2A5R3BA01#					±0.5pF	GRM1885C2A6R6DA01#	
				±0.25pF	GRM1885C2A5R3CA01#					6.7pF	±0.05pF	GRM1885C2A6R7WA01#
				±0.5pF	GRM1885C2A5R3DA01#						±0.1pF	GRM1885C2A6R7BA01#
			5.4pF	±0.05pF	GRM1885C2A5R4WA01#				±0.25pF	GRM1885C2A6R7CA01#		
				±0.1pF	GRM1885C2A5R4BA01#				±0.5pF	GRM1885C2A6R7DA01#		
				±0.25pF	GRM1885C2A5R4CA01#				6.8pF	±0.05pF	GRM1885C2A6R8WA01#	
				±0.5pF	GRM1885C2A5R4DA01#					±0.1pF	GRM1885C2A6R8BA01#	
			5.5pF	±0.05pF	GRM1885C2A5R5WA01#				±0.25pF	GRM1885C2A6R8CA01#		
				±0.1pF	GRM1885C2A5R5BA01#				±0.5pF	GRM1885C2A6R8DA01#		
				±0.25pF	GRM1885C2A5R5CA01#				6.9pF	±0.05pF	GRM1885C2A6R9WA01#	
				±0.5pF	GRM1885C2A5R5DA01#					±0.1pF	GRM1885C2A6R9BA01#	
			5.6pF	±0.05pF	GRM1885C2A5R6WA01#				±0.25pF	GRM1885C2A6R9CA01#		
				±0.1pF	GRM1885C2A5R6BA01#				±0.5pF	GRM1885C2A6R9DA01#		
				±0.25pF	GRM1885C2A5R6CA01#				7.0pF	±0.05pF	GRM1885C2A7R0WA01#	
				±0.5pF	GRM1885C2A5R6DA01#					±0.1pF	GRM1885C2A7R0BA01#	
			5.7pF	±0.05pF	GRM1885C2A5R7WA01#				±0.25pF	GRM1885C2A7R0CA01#		
				±0.1pF	GRM1885C2A5R7BA01#				±0.5pF	GRM1885C2A7R0DA01#		
				±0.25pF	GRM1885C2A5R7CA01#				7.1pF	±0.05pF	GRM1885C2A7R1WA01#	
				±0.5pF	GRM1885C2A5R7DA01#					±0.1pF	GRM1885C2A7R1BA01#	
			5.8pF	±0.05pF	GRM1885C2A5R8WA01#				±0.25pF	GRM1885C2A7R1CA01#		
				±0.1pF	GRM1885C2A5R8BA01#				±0.5pF	GRM1885C2A7R1DA01#		
				±0.25pF	GRM1885C2A5R8CA01#				7.2pF	±0.05pF	GRM1885C2A7R2WA01#	
				±0.5pF	GRM1885C2A5R8DA01#					±0.1pF	GRM1885C2A7R2BA01#	
			5.9pF	±0.05pF	GRM1885C2A5R9WA01#				±0.25pF	GRM1885C2A7R2CA01#		
				±0.1pF	GRM1885C2A5R9BA01#				±0.5pF	GRM1885C2A7R2DA01#		
				±0.25pF	GRM1885C2A5R9CA01#				7.3pF	±0.05pF	GRM1885C2A7R3WA01#	
				±0.5pF	GRM1885C2A5R9DA01#					±0.1pF	GRM1885C2A7R3BA01#	
			6.0pF	±0.05pF	GRM1885C2A6R0WA01#				±0.25pF	GRM1885C2A7R3CA01#		
				±0.1pF	GRM1885C2A6R0BA01#				±0.5pF	GRM1885C2A7R3DA01#		
				±0.25pF	GRM1885C2A6R0CA01#				7.4pF	±0.05pF	GRM1885C2A7R4WA01#	
				±0.5pF	GRM1885C2A6R0DA01#					±0.1pF	GRM1885C2A7R4BA01#	
			6.1pF	±0.05pF	GRM1885C2A6R1WA01#				±0.25pF	GRM1885C2A7R4CA01#		
				±0.1pF	GRM1885C2A6R1BA01#				±0.5pF	GRM1885C2A7R4DA01#		
				±0.25pF	GRM1885C2A6R1CA01#				7.5pF	±0.05pF	GRM1885C2A7R5WA01#	
				±0.5pF	GRM1885C2A6R1DA01#					±0.1pF	GRM1885C2A7R5BA01#	
			6.2pF	±0.05pF	GRM1885C2A6R2WA01#				±0.25pF	GRM1885C2A7R5CA01#		
				±0.1pF	GRM1885C2A6R2BA01#				±0.5pF	GRM1885C2A7R5DA01#		
				±0.25pF	GRM1885C2A6R2CA01#				7.6pF	±0.05pF	GRM1885C2A7R6WA01#	
				±0.5pF	GRM1885C2A6R2DA01#					±0.1pF	GRM1885C2A7R6BA01#	
			6.3pF	±0.05pF	GRM1885C2A6R3WA01#				±0.25pF	GRM1885C2A7R6CA01#		
				±0.1pF	GRM1885C2A6R3BA01#				±0.5pF	GRM1885C2A7R6DA01#		
				±0.25pF	GRM1885C2A6R3CA01#				7.7pF	±0.05pF	GRM1885C2A7R7WA01#	
				±0.5pF	GRM1885C2A6R3DA01#					±0.1pF	GRM1885C2A7R7BA01#	
			6.4pF	±0.05pF	GRM1885C2A6R4WA01#				±0.25pF	GRM1885C2A7R7CA01#		
				±0.1pF	GRM1885C2A6R4BA01#				±0.5pF	GRM1885C2A7R7DA01#		
				±0.25pF	GRM1885C2A6R4CA01#				7.8pF	±0.05pF	GRM1885C2A7R8WA01#	
				±0.5pF	GRM1885C2A6R4DA01#					±0.1pF	GRM1885C2A7R8BA01#	
			6.5pF	±0.05pF	GRM1885C2A6R5WA01#				±0.25pF	GRM1885C2A7R8CA01#		
				±0.1pF	GRM1885C2A6R5BA01#				±0.5pF	GRM1885C2A7R8DA01#		
				±0.25pF	GRM1885C2A6R5CA01#				7.9pF	±0.05pF	GRM1885C2A7R9WA01#	
				±0.5pF	GRM1885C2A6R5DA01#					±0.1pF	GRM1885C2A7R9BA01#	
			6.6pF	±0.05pF	GRM1885C2A6R6WA01#				±0.25pF	GRM1885C2A7R9CA01#		
				±0.1pF	GRM1885C2A6R6BA01#				±0.5pF	GRM1885C2A7R9DA01#		

Part number # indicates the package specification code.



GRM Series Temperature Compensating Type Part Number List

(→ 1.6×0.8mm)

T max.	Rated Voltage	TC Code	Cap.	Tol.	Part Number	T max.	Rated Voltage	TC Code	Cap.	Tol.	Part Number	
0.9mm	100Vdc	COG	8.0pF	±0.05pF	GRM1885C2A8R0WA01#	0.9mm	100Vdc	COG	9.3pF	±0.25pF	GRM1885C2A9R3CA01#	
				±0.1pF	GRM1885C2A8R0BA01#					±0.5pF	GRM1885C2A9R3DA01#	
				±0.25pF	GRM1885C2A8R0CA01#					9.4pF	±0.05pF	GRM1885C2A9R4WA01#
				±0.5pF	GRM1885C2A8R0DA01#						±0.1pF	GRM1885C2A9R4BA01#
			8.1pF	±0.05pF	GRM1885C2A8R1WA01#				±0.25pF		GRM1885C2A9R4CA01#	
				±0.1pF	GRM1885C2A8R1BA01#				±0.5pF		GRM1885C2A9R4DA01#	
				±0.25pF	GRM1885C2A8R1CA01#				9.5pF	±0.05pF	GRM1885C2A9R5WA01#	
				±0.5pF	GRM1885C2A8R1DA01#					±0.1pF	GRM1885C2A9R5BA01#	
			8.2pF	±0.05pF	GRM1885C2A8R2WA01#					±0.25pF	GRM1885C2A9R5CA01#	
				±0.1pF	GRM1885C2A8R2BA01#					±0.5pF	GRM1885C2A9R5DA01#	
				±0.25pF	GRM1885C2A8R2CA01#				9.6pF	±0.05pF	GRM1885C2A9R6WA01#	
				±0.5pF	GRM1885C2A8R2DA01#					±0.1pF	GRM1885C2A9R6BA01#	
			8.3pF	±0.05pF	GRM1885C2A8R3WA01#					±0.25pF	GRM1885C2A9R6CA01#	
				±0.1pF	GRM1885C2A8R3BA01#					±0.5pF	GRM1885C2A9R6DA01#	
				±0.25pF	GRM1885C2A8R3CA01#				9.7pF	±0.05pF	GRM1885C2A9R7WA01#	
				±0.5pF	GRM1885C2A8R3DA01#					±0.1pF	GRM1885C2A9R7BA01#	
			8.4pF	±0.05pF	GRM1885C2A8R4WA01#					±0.25pF	GRM1885C2A9R7CA01#	
				±0.1pF	GRM1885C2A8R4BA01#					±0.5pF	GRM1885C2A9R7DA01#	
				±0.25pF	GRM1885C2A8R4CA01#				9.8pF	±0.05pF	GRM1885C2A9R8WA01#	
				±0.5pF	GRM1885C2A8R4DA01#					±0.1pF	GRM1885C2A9R8BA01#	
			8.5pF	±0.05pF	GRM1885C2A8R5WA01#					±0.25pF	GRM1885C2A9R8CA01#	
				±0.1pF	GRM1885C2A8R5BA01#					±0.5pF	GRM1885C2A9R8DA01#	
				±0.25pF	GRM1885C2A8R5CA01#				9.9pF	±0.05pF	GRM1885C2A9R9WA01#	
				±0.5pF	GRM1885C2A8R5DA01#					±0.1pF	GRM1885C2A9R9BA01#	
			8.6pF	±0.05pF	GRM1885C2A8R6WA01#					±0.25pF	GRM1885C2A9R9CA01#	
				±0.1pF	GRM1885C2A8R6BA01#					±0.5pF	GRM1885C2A9R9DA01#	
				±0.25pF	GRM1885C2A8R6CA01#				10pF	±5%	GRM1885C2A100JA01#	
				±0.5pF	GRM1885C2A8R6DA01#				12pF	±5%	GRM1885C2A120JA01#	
			8.7pF	±0.05pF	GRM1885C2A8R7WA01#				15pF	±5%	GRM1885C2A150JA01#	
				±0.1pF	GRM1885C2A8R7BA01#				18pF	±5%	GRM1885C2A180JA01#	
				±0.25pF	GRM1885C2A8R7CA01#				22pF	±5%	GRM1885C2A220JA01#	
				±0.5pF	GRM1885C2A8R7DA01#				27pF	±5%	GRM1885C2A270JA01#	
			8.8pF	±0.05pF	GRM1885C2A8R8WA01#				33pF	±5%	GRM1885C2A330JA01#	
				±0.1pF	GRM1885C2A8R8BA01#				39pF	±5%	GRM1885C2A390JA01#	
				±0.25pF	GRM1885C2A8R8CA01#				47pF	±5%	GRM1885C2A470JA01#	
				±0.5pF	GRM1885C2A8R8DA01#				56pF	±5%	GRM1885C2A560JA01#	
			8.9pF	±0.05pF	GRM1885C2A8R9WA01#				68pF	±5%	GRM1885C2A680JA01#	
				±0.1pF	GRM1885C2A8R9BA01#				82pF	±5%	GRM1885C2A820JA01#	
				±0.25pF	GRM1885C2A8R9CA01#				100pF	±5%	GRM1885C2A101JA01#	
				±0.5pF	GRM1885C2A8R9DA01#				120pF	±5%	GRM1885C2A121JA01#	
			9.0pF	±0.05pF	GRM1885C2A9R0WA01#				150pF	±5%	GRM1885C2A151JA01#	
				±0.1pF	GRM1885C2A9R0BA01#				180pF	±5%	GRM1885C2A181JA01#	
				±0.25pF	GRM1885C2A9R0CA01#				220pF	±5%	GRM1885C2A221JA01#	
				±0.5pF	GRM1885C2A9R0DA01#				270pF	±5%	GRM1885C2A271JA01#	
			9.1pF	±0.05pF	GRM1885C2A9R1WA01#				330pF	±5%	GRM1885C2A331JA01#	
				±0.1pF	GRM1885C2A9R1BA01#				390pF	±5%	GRM1885C2A391JA01#	
				±0.25pF	GRM1885C2A9R1CA01#				470pF	±5%	GRM1885C2A471JA01#	
				±0.5pF	GRM1885C2A9R1DA01#				560pF	±5%	GRM1885C2A561JA01#	
			9.2pF	±0.05pF	GRM1885C2A9R2WA01#				680pF	±5%	GRM1885C2A681JA01#	
				±0.1pF	GRM1885C2A9R2BA01#				820pF	±5%	GRM1885C2A821JA01#	
				±0.25pF	GRM1885C2A9R2CA01#				1000pF	±5%	GRM1885C2A102JA01#	
				±0.5pF	GRM1885C2A9R2DA01#				1200pF	±5%	GRM1885C2A122JA01#	
			9.3pF	±0.05pF	GRM1885C2A9R3WA01#				1500pF	±5%	GRM1885C2A152JA01#	
				±0.1pF	GRM1885C2A9R3BA01#				CK	0.50pF	±0.05pF	GRM1884C2AR50WA01#

GRM
 GR3
 GRJ
 GR4
 GR7
 GJM
 GQM
 GA2
 GA3 GB
 GA3 GD
 GA3 GF
 LLL
 LLA
 LLM
 LLR
 NFM
 KRM
 KR3
 GMA
 GMD
 ⚠Caution /Notice

Part number # indicates the package specification code.

GRM Series Temperature Compensating Type Part Number List

(→ 1.6×0.8mm)

T max.	Rated Voltage	TC Code	Cap.	Tol.	Part Number	T max.	Rated Voltage	TC Code	Cap.	Tol.	Part Number
0.9mm	100Vdc	CK	0.50pF	±0.1pF	GRM1884C2AR50BA01#	0.9mm	100Vdc	CJ	2.5pF	±0.05pF	GRM1883C2A2R5WA01#
				±0.05pF	GRM1884C2AR60WA01#					±0.1pF	GRM1883C2A2R5BA01#
				±0.1pF	GRM1884C2AR60BA01#					±0.25pF	GRM1883C2A2R5CA01#
			0.70pF	±0.05pF	GRM1884C2AR70WA01#				2.6pF	±0.05pF	GRM1883C2A2R6WA01#
				±0.1pF	GRM1884C2AR70BA01#					±0.1pF	GRM1883C2A2R6BA01#
				±0.25pF	GRM1884C2AR80WA01#					±0.25pF	GRM1883C2A2R6CA01#
			0.80pF	±0.05pF	GRM1884C2AR80WA01#				2.7pF	±0.05pF	GRM1883C2A2R7WA01#
				±0.1pF	GRM1884C2AR80BA01#					±0.1pF	GRM1883C2A2R7BA01#
				±0.25pF	GRM1884C2AR90WA01#					±0.25pF	GRM1883C2A2R7CA01#
			0.90pF	±0.05pF	GRM1884C2AR90WA01#				2.8pF	±0.05pF	GRM1883C2A2R8WA01#
				±0.1pF	GRM1884C2AR90BA01#					±0.1pF	GRM1883C2A2R8BA01#
				±0.25pF	GRM1884C2A1R0WA01#					±0.25pF	GRM1883C2A2R8CA01#
			1.0pF	±0.05pF	GRM1884C2A1R0WA01#				2.9pF	±0.05pF	GRM1883C2A2R9WA01#
				±0.1pF	GRM1884C2A1R0BA01#					±0.1pF	GRM1883C2A2R9BA01#
				±0.25pF	GRM1884C2A1R0CA01#					±0.25pF	GRM1883C2A2R9CA01#
			1.1pF	±0.05pF	GRM1884C2A1R1WA01#				3.0pF	±0.05pF	GRM1883C2A3R0WA01#
				±0.1pF	GRM1884C2A1R1BA01#					±0.1pF	GRM1883C2A3R0BA01#
				±0.25pF	GRM1884C2A1R1CA01#					±0.25pF	GRM1883C2A3R0CA01#
			1.2pF	±0.05pF	GRM1884C2A1R2WA01#				3.1pF	±0.05pF	GRM1883C2A3R1WA01#
				±0.1pF	GRM1884C2A1R2BA01#					±0.1pF	GRM1883C2A3R1BA01#
				±0.25pF	GRM1884C2A1R2CA01#					±0.25pF	GRM1883C2A3R1CA01#
			1.3pF	±0.05pF	GRM1884C2A1R3WA01#				3.2pF	±0.05pF	GRM1883C2A3R2WA01#
				±0.1pF	GRM1884C2A1R3BA01#					±0.1pF	GRM1883C2A3R2BA01#
				±0.25pF	GRM1884C2A1R3CA01#					±0.25pF	GRM1883C2A3R2CA01#
		1.4pF	±0.05pF	GRM1884C2A1R4WA01#	3.3pF	±0.05pF	GRM1883C2A3R3WA01#				
			±0.1pF	GRM1884C2A1R4BA01#		±0.1pF	GRM1883C2A3R3BA01#				
			±0.25pF	GRM1884C2A1R4CA01#		±0.25pF	GRM1883C2A3R3CA01#				
		1.5pF	±0.05pF	GRM1884C2A1R5WA01#	3.4pF	±0.05pF	GRM1883C2A3R4WA01#				
			±0.1pF	GRM1884C2A1R5BA01#		±0.1pF	GRM1883C2A3R4BA01#				
			±0.25pF	GRM1884C2A1R5CA01#		±0.25pF	GRM1883C2A3R4CA01#				
		1.6pF	±0.05pF	GRM1884C2A1R6WA01#	3.5pF	±0.05pF	GRM1883C2A3R5WA01#				
			±0.1pF	GRM1884C2A1R6BA01#		±0.1pF	GRM1883C2A3R5BA01#				
			±0.25pF	GRM1884C2A1R6CA01#		±0.25pF	GRM1883C2A3R5CA01#				
		1.7pF	±0.05pF	GRM1884C2A1R7WA01#	3.6pF	±0.05pF	GRM1883C2A3R6WA01#				
			±0.1pF	GRM1884C2A1R7BA01#		±0.1pF	GRM1883C2A3R6BA01#				
			±0.25pF	GRM1884C2A1R7CA01#		±0.25pF	GRM1883C2A3R6CA01#				
		1.8pF	±0.05pF	GRM1884C2A1R8WA01#	3.7pF	±0.05pF	GRM1883C2A3R7WA01#				
			±0.1pF	GRM1884C2A1R8BA01#		±0.1pF	GRM1883C2A3R7BA01#				
			±0.25pF	GRM1884C2A1R8CA01#		±0.25pF	GRM1883C2A3R7CA01#				
		1.9pF	±0.05pF	GRM1884C2A1R9WA01#	3.8pF	±0.05pF	GRM1883C2A3R8WA01#				
			±0.1pF	GRM1884C2A1R9BA01#		±0.1pF	GRM1883C2A3R8BA01#				
			±0.25pF	GRM1884C2A2R0WA01#		±0.25pF	GRM1883C2A3R8CA01#				
		2.0pF	±0.05pF	GRM1884C2A2R0WA01#	3.9pF	±0.05pF	GRM1883C2A3R9WA01#				
			±0.1pF	GRM1884C2A2R0BA01#		±0.1pF	GRM1883C2A3R9BA01#				
			±0.25pF	GRM1884C2A2R0CA01#		±0.25pF	GRM1883C2A3R9CA01#				
		CJ	100Vdc	CJ	2.1pF	±0.05pF	GRM1883C2A2R1WA01#	CH	4.0pF	±0.05pF	GRM1882C2A4R0WA01#
						±0.1pF	GRM1883C2A2R1BA01#			±0.1pF	GRM1882C2A4R0BA01#
						±0.25pF	GRM1883C2A2R1CA01#			±0.25pF	GRM1882C2A4R0CA01#
2.2pF	±0.05pF				GRM1883C2A2R2WA01#	4.1pF	±0.05pF		GRM1882C2A4R1WA01#		
	±0.1pF				GRM1883C2A2R2BA01#		±0.1pF		GRM1882C2A4R1BA01#		
	±0.25pF				GRM1883C2A2R2CA01#		±0.25pF		GRM1882C2A4R1CA01#		
2.3pF	±0.05pF				GRM1883C2A2R3WA01#	4.2pF	±0.05pF		GRM1882C2A4R2WA01#		
	±0.1pF				GRM1883C2A2R3BA01#		±0.1pF		GRM1882C2A4R2BA01#		
	±0.25pF				GRM1883C2A2R3CA01#		±0.25pF		GRM1882C2A4R2CA01#		
2.4pF	±0.05pF				GRM1883C2A2R4WA01#						
	±0.1pF				GRM1883C2A2R4BA01#						
	±0.25pF				GRM1883C2A2R4CA01#						

Part number # indicates the package specification code.

GRM Series Temperature Compensating Type Part Number List

(→ 1.6×0.8mm)

T max.	Rated Voltage	TC Code	Cap.	Tol.	Part Number	T max.	Rated Voltage	TC Code	Cap.	Tol.	Part Number
0.9mm	100Vdc	CH	4.3pF	±0.05pF	GRM1882C2A4R3WA01#	0.9mm	100Vdc	CH	5.8pF	±0.25pF	GRM1882C2A5R8CA01#
				±0.1pF	GRM1882C2A4R3BA01#					±0.5pF	GRM1882C2A5R8DA01#
				±0.25pF	GRM1882C2A4R3CA01#					±0.05pF	GRM1882C2A5R9WA01#
			4.4pF	±0.05pF	GRM1882C2A4R4WA01#				5.9pF	±0.1pF	GRM1882C2A5R9BA01#
				±0.1pF	GRM1882C2A4R4BA01#					±0.25pF	GRM1882C2A5R9CA01#
				±0.25pF	GRM1882C2A4R4CA01#					±0.5pF	GRM1882C2A5R9DA01#
			4.5pF	±0.05pF	GRM1882C2A4R5WA01#				6.0pF	±0.05pF	GRM1882C2A6R0WA01#
				±0.1pF	GRM1882C2A4R5BA01#					±0.1pF	GRM1882C2A6R0BA01#
				±0.25pF	GRM1882C2A4R5CA01#					±0.25pF	GRM1882C2A6R0CA01#
			4.6pF	±0.05pF	GRM1882C2A4R6WA01#				6.1pF	±0.05pF	GRM1882C2A6R1WA01#
				±0.1pF	GRM1882C2A4R6BA01#					±0.1pF	GRM1882C2A6R1BA01#
				±0.25pF	GRM1882C2A4R6CA01#					±0.25pF	GRM1882C2A6R1CA01#
			4.7pF	±0.05pF	GRM1882C2A4R7WA01#				6.2pF	±0.05pF	GRM1882C2A6R2WA01#
				±0.1pF	GRM1882C2A4R7BA01#					±0.1pF	GRM1882C2A6R2BA01#
				±0.25pF	GRM1882C2A4R7CA01#					±0.25pF	GRM1882C2A6R2CA01#
			4.8pF	±0.05pF	GRM1882C2A4R8WA01#				6.3pF	±0.5pF	GRM1882C2A6R2DA01#
				±0.1pF	GRM1882C2A4R8BA01#					±0.05pF	GRM1882C2A6R3WA01#
				±0.25pF	GRM1882C2A4R8CA01#					±0.1pF	GRM1882C2A6R3BA01#
			4.9pF	±0.05pF	GRM1882C2A4R9WA01#				6.4pF	±0.25pF	GRM1882C2A6R3CA01#
				±0.1pF	GRM1882C2A4R9BA01#					±0.5pF	GRM1882C2A6R3DA01#
				±0.25pF	GRM1882C2A4R9CA01#					±0.05pF	GRM1882C2A6R4WA01#
			5.0pF	±0.05pF	GRM1882C2A5R0WA01#				6.5pF	±0.1pF	GRM1882C2A6R4BA01#
				±0.1pF	GRM1882C2A5R0BA01#					±0.25pF	GRM1882C2A6R4CA01#
				±0.25pF	GRM1882C2A5R0CA01#					±0.5pF	GRM1882C2A6R4DA01#
			5.1pF	±0.05pF	GRM1882C2A5R1WA01#				6.6pF	±0.05pF	GRM1882C2A6R5WA01#
				±0.1pF	GRM1882C2A5R1BA01#					±0.1pF	GRM1882C2A6R5BA01#
				±0.25pF	GRM1882C2A5R1CA01#					±0.25pF	GRM1882C2A6R5CA01#
				±0.5pF	GRM1882C2A5R1DA01#					±0.5pF	GRM1882C2A6R5DA01#
			5.2pF	±0.05pF	GRM1882C2A5R2WA01#				6.7pF	±0.05pF	GRM1882C2A6R6WA01#
				±0.1pF	GRM1882C2A5R2BA01#					±0.1pF	GRM1882C2A6R6BA01#
				±0.25pF	GRM1882C2A5R2CA01#					±0.25pF	GRM1882C2A6R6CA01#
				±0.5pF	GRM1882C2A5R2DA01#					±0.5pF	GRM1882C2A6R6DA01#
			5.3pF	±0.05pF	GRM1882C2A5R3WA01#				6.8pF	±0.05pF	GRM1882C2A6R7WA01#
				±0.1pF	GRM1882C2A5R3BA01#					±0.1pF	GRM1882C2A6R7BA01#
				±0.25pF	GRM1882C2A5R3CA01#					±0.25pF	GRM1882C2A6R7CA01#
				±0.5pF	GRM1882C2A5R3DA01#					±0.5pF	GRM1882C2A6R7DA01#
			5.4pF	±0.05pF	GRM1882C2A5R4WA01#				6.9pF	±0.05pF	GRM1882C2A6R8WA01#
				±0.1pF	GRM1882C2A5R4BA01#					±0.1pF	GRM1882C2A6R8BA01#
				±0.25pF	GRM1882C2A5R4CA01#					±0.25pF	GRM1882C2A6R8CA01#
				±0.5pF	GRM1882C2A5R4DA01#					±0.5pF	GRM1882C2A6R8DA01#
			5.5pF	±0.05pF	GRM1882C2A5R5WA01#				7.0pF	±0.05pF	GRM1882C2A7R0WA01#
				±0.1pF	GRM1882C2A5R5BA01#					±0.1pF	GRM1882C2A7R0BA01#
				±0.25pF	GRM1882C2A5R5CA01#					±0.25pF	GRM1882C2A7R0CA01#
				±0.5pF	GRM1882C2A5R5DA01#					±0.5pF	GRM1882C2A7R0DA01#
			5.6pF	±0.05pF	GRM1882C2A5R6WA01#				7.1pF	±0.05pF	GRM1882C2A7R1WA01#
				±0.1pF	GRM1882C2A5R6BA01#					±0.1pF	GRM1882C2A7R1BA01#
				±0.25pF	GRM1882C2A5R6CA01#					±0.25pF	GRM1882C2A7R1CA01#
				±0.5pF	GRM1882C2A5R6DA01#					±0.5pF	GRM1882C2A7R1DA01#
			5.7pF	±0.05pF	GRM1882C2A5R7WA01#						
				±0.1pF	GRM1882C2A5R7BA01#						
				±0.25pF	GRM1882C2A5R7CA01#						
				±0.5pF	GRM1882C2A5R7DA01#						
			5.8pF	±0.05pF	GRM1882C2A5R8WA01#						
				±0.1pF	GRM1882C2A5R8BA01#						

GRM
 GR3
 GRJ
 GR4
 GR7
 GJM
 GQM
 GA2
 GA3 GB
 GA3 GD
 GA3 GF
 LLL
 LLA
 LLM
 LLR
 NFM
 KRM
 KR3
 GMA
 GMD
 ⚠Caution /Notice

Part number # indicates the package specification code.

GRM Series Temperature Compensating Type Part Number List

(→ 1.6×0.8mm)

T max.	Rated Voltage	TC Code	Cap.	Tol.	Part Number
0.9mm	100Vdc	CH	7.2pF	±0.05pF	GRM1882C2A7R2WA01#
				±0.1pF	GRM1882C2A7R2BA01#
				±0.25pF	GRM1882C2A7R2CA01#
				±0.5pF	GRM1882C2A7R2DA01#
			7.3pF	±0.05pF	GRM1882C2A7R3WA01#
				±0.1pF	GRM1882C2A7R3BA01#
				±0.25pF	GRM1882C2A7R3CA01#
				±0.5pF	GRM1882C2A7R3DA01#
			7.4pF	±0.05pF	GRM1882C2A7R4WA01#
				±0.1pF	GRM1882C2A7R4BA01#
				±0.25pF	GRM1882C2A7R4CA01#
				±0.5pF	GRM1882C2A7R4DA01#
			7.5pF	±0.05pF	GRM1882C2A7R5WA01#
				±0.1pF	GRM1882C2A7R5BA01#
				±0.25pF	GRM1882C2A7R5CA01#
				±0.5pF	GRM1882C2A7R5DA01#
			7.6pF	±0.05pF	GRM1882C2A7R6WA01#
				±0.1pF	GRM1882C2A7R6BA01#
				±0.25pF	GRM1882C2A7R6CA01#
				±0.5pF	GRM1882C2A7R6DA01#
			7.7pF	±0.05pF	GRM1882C2A7R7WA01#
				±0.1pF	GRM1882C2A7R7BA01#
				±0.25pF	GRM1882C2A7R7CA01#
				±0.5pF	GRM1882C2A7R7DA01#
			7.8pF	±0.05pF	GRM1882C2A7R8WA01#
				±0.1pF	GRM1882C2A7R8BA01#
				±0.25pF	GRM1882C2A7R8CA01#
				±0.5pF	GRM1882C2A7R8DA01#
			7.9pF	±0.05pF	GRM1882C2A7R9WA01#
				±0.1pF	GRM1882C2A7R9BA01#
				±0.25pF	GRM1882C2A7R9CA01#
				±0.5pF	GRM1882C2A7R9DA01#
			8.0pF	±0.05pF	GRM1882C2A8R0WA01#
				±0.1pF	GRM1882C2A8R0BA01#
				±0.25pF	GRM1882C2A8R0CA01#
				±0.5pF	GRM1882C2A8R0DA01#
			8.1pF	±0.05pF	GRM1882C2A8R1WA01#
				±0.1pF	GRM1882C2A8R1BA01#
				±0.25pF	GRM1882C2A8R1CA01#
				±0.5pF	GRM1882C2A8R1DA01#
			8.2pF	±0.05pF	GRM1882C2A8R2WA01#
				±0.1pF	GRM1882C2A8R2BA01#
				±0.25pF	GRM1882C2A8R2CA01#
				±0.5pF	GRM1882C2A8R2DA01#
			8.3pF	±0.05pF	GRM1882C2A8R3WA01#
				±0.1pF	GRM1882C2A8R3BA01#
				±0.25pF	GRM1882C2A8R3CA01#
				±0.5pF	GRM1882C2A8R3DA01#
			8.4pF	±0.05pF	GRM1882C2A8R4WA01#
				±0.1pF	GRM1882C2A8R4BA01#
				±0.25pF	GRM1882C2A8R4CA01#
				±0.5pF	GRM1882C2A8R4DA01#
			8.5pF	±0.05pF	GRM1882C2A8R5WA01#
				±0.1pF	GRM1882C2A8R5BA01#

T max.	Rated Voltage	TC Code	Cap.	Tol.	Part Number
0.9mm	100Vdc	CH	8.5pF	±0.25pF	GRM1882C2A8R5CA01#
				±0.5pF	GRM1882C2A8R5DA01#
			8.6pF	±0.05pF	GRM1882C2A8R6WA01#
				±0.1pF	GRM1882C2A8R6BA01#
				±0.25pF	GRM1882C2A8R6CA01#
				±0.5pF	GRM1882C2A8R6DA01#
			8.7pF	±0.05pF	GRM1882C2A8R7WA01#
				±0.1pF	GRM1882C2A8R7BA01#
				±0.25pF	GRM1882C2A8R7CA01#
				±0.5pF	GRM1882C2A8R7DA01#
			8.8pF	±0.05pF	GRM1882C2A8R8WA01#
				±0.1pF	GRM1882C2A8R8BA01#
				±0.25pF	GRM1882C2A8R8CA01#
				±0.5pF	GRM1882C2A8R8DA01#
			8.9pF	±0.05pF	GRM1882C2A8R9WA01#
				±0.1pF	GRM1882C2A8R9BA01#
				±0.25pF	GRM1882C2A8R9CA01#
				±0.5pF	GRM1882C2A8R9DA01#
			9.0pF	±0.05pF	GRM1882C2A9R0WA01#
				±0.1pF	GRM1882C2A9R0BA01#
				±0.25pF	GRM1882C2A9R0CA01#
				±0.5pF	GRM1882C2A9R0DA01#
			9.1pF	±0.05pF	GRM1882C2A9R1WA01#
				±0.1pF	GRM1882C2A9R1BA01#
				±0.25pF	GRM1882C2A9R1CA01#
				±0.5pF	GRM1882C2A9R1DA01#
			9.2pF	±0.05pF	GRM1882C2A9R2WA01#
				±0.1pF	GRM1882C2A9R2BA01#
				±0.25pF	GRM1882C2A9R2CA01#
				±0.5pF	GRM1882C2A9R2DA01#
			9.3pF	±0.05pF	GRM1882C2A9R3WA01#
				±0.1pF	GRM1882C2A9R3BA01#
				±0.25pF	GRM1882C2A9R3CA01#
				±0.5pF	GRM1882C2A9R3DA01#
			9.4pF	±0.05pF	GRM1882C2A9R4WA01#
				±0.1pF	GRM1882C2A9R4BA01#
				±0.25pF	GRM1882C2A9R4CA01#
				±0.5pF	GRM1882C2A9R4DA01#
			9.5pF	±0.05pF	GRM1882C2A9R5WA01#
				±0.1pF	GRM1882C2A9R5BA01#
				±0.25pF	GRM1882C2A9R5CA01#
				±0.5pF	GRM1882C2A9R5DA01#
			9.6pF	±0.05pF	GRM1882C2A9R6WA01#
				±0.1pF	GRM1882C2A9R6BA01#
				±0.25pF	GRM1882C2A9R6CA01#
				±0.5pF	GRM1882C2A9R6DA01#
			9.7pF	±0.05pF	GRM1882C2A9R7WA01#
				±0.1pF	GRM1882C2A9R7BA01#
				±0.25pF	GRM1882C2A9R7CA01#
				±0.5pF	GRM1882C2A9R7DA01#
			9.8pF	±0.05pF	GRM1882C2A9R8WA01#
				±0.1pF	GRM1882C2A9R8BA01#
				±0.25pF	GRM1882C2A9R8CA01#
				±0.5pF	GRM1882C2A9R8DA01#

Part number # indicates the package specification code.

GRM
 GR3
 GRJ
 GR4
 GR7
 GJM
 GQM
 GA2
 GA3 GB
 GA3 GD
 GA3 GF
 LLL
 LLA
 LLM
 LLR
 NFM
 KRM
 KR3
 GMA
 GMD
 ⚠Caution /Notice

GRM Series Temperature Compensating Type Part Number List

(→ 1.6×0.8mm)

T max.	Rated Voltage	TC Code	Cap.	Tol.	Part Number	T max.	Rated Voltage	TC Code	Cap.	Tol.	Part Number		
0.9mm	100Vdc	CH	9.9pF	±0.05pF	GRM1882C2A9R9WA01#	0.9mm	50Vdc	COG	1.4pF	±0.1pF	GRM1885C1H1R4BA01#		
				±0.1pF	GRM1882C2A9R9BA01#					±0.25pF	GRM1885C1H1R4CA01#		
				±0.25pF	GRM1882C2A9R9CA01#					1.5pF	±0.05pF	GRM1885C1H1R5WA01#	
				±0.5pF	GRM1882C2A9R9DA01#						±0.1pF	GRM1885C1H1R5BA01#	
			10pF	±5%	GRM1882C2A100JA01#				1.6pF	±0.25pF	GRM1885C1H1R5CA01#		
			12pF	±5%	GRM1882C2A120JA01#					±0.05pF	GRM1885C1H1R6WA01#		
			15pF	±5%	GRM1882C2A150JA01#				±0.1pF	GRM1885C1H1R6BA01#			
			18pF	±5%	GRM1882C2A180JA01#				±0.25pF	GRM1885C1H1R6CA01#			
			22pF	±5%	GRM1882C2A220JA01#				1.7pF	±0.05pF	GRM1885C1H1R7WA01#		
			27pF	±5%	GRM1882C2A270JA01#					±0.1pF	GRM1885C1H1R7BA01#		
			33pF	±5%	GRM1882C2A330JA01#				±0.25pF	GRM1885C1H1R7CA01#			
			39pF	±5%	GRM1882C2A390JA01#				1.8pF	±0.05pF	GRM1885C1H1R8WA01#		
			47pF	±5%	GRM1882C2A470JA01#					±0.1pF	GRM1885C1H1R8BA01#		
			56pF	±5%	GRM1882C2A560JA01#				±0.25pF	GRM1885C1H1R8CA01#			
			68pF	±5%	GRM1882C2A680JA01#				1.9pF	±0.05pF	GRM1885C1H1R9WA01#		
			82pF	±5%	GRM1882C2A820JA01#					±0.1pF	GRM1885C1H1R9BA01#		
			100pF	±5%	GRM1882C2A101JA01#				±0.25pF	GRM1885C1H1R9CA01#			
			120pF	±5%	GRM1882C2A121JA01#				2.0pF	±0.05pF	GRM1885C1H2R0WA01#		
			150pF	±5%	GRM1882C2A151JA01#					±0.1pF	GRM1885C1H2R0BA01#		
			180pF	±5%	GRM1882C2A181JA01#				±0.25pF	GRM1885C1H2R0CA01#			
			220pF	±5%	GRM1882C2A221JA01#				2.1pF	±0.05pF	GRM1885C1H2R1WA01#		
			270pF	±5%	GRM1882C2A271JA01#					±0.1pF	GRM1885C1H2R1BA01#		
			330pF	±5%	GRM1882C2A331JA01#				±0.25pF	GRM1885C1H2R1CA01#			
			390pF	±5%	GRM1882C2A391JA01#				2.2pF	±0.05pF	GRM1885C1H2R2WA01#		
			470pF	±5%	GRM1882C2A471JA01#					±0.1pF	GRM1885C1H2R2BA01#		
			560pF	±5%	GRM1882C2A561JA01#				±0.25pF	GRM1885C1H2R2CA01#			
			680pF	±5%	GRM1882C2A681JA01#				2.3pF	±0.05pF	GRM1885C1H2R3WA01#		
			820pF	±5%	GRM1882C2A821JA01#					±0.1pF	GRM1885C1H2R3BA01#		
			1000pF	±5%	GRM1882C2A102JA01#				±0.25pF	GRM1885C1H2R3CA01#			
			1200pF	±5%	GRM1882C2A122JA01#				2.4pF	±0.05pF	GRM1885C1H2R4WA01#		
			1500pF	±5%	GRM1882C2A152JA01#					±0.1pF	GRM1885C1H2R4BA01#		
			50Vdc	COG	COG				0.50pF	±0.05pF	GRM1885C1HR50WA01#	±0.25pF	GRM1885C1H2R4CA01#
										±0.1pF	GRM1885C1HR50BA01#	2.5pF	±0.05pF
									0.60pF	±0.05pF	GRM1885C1HR60WA01#		±0.1pF
									±0.1pF	GRM1885C1HR60BA01#	±0.25pF	GRM1885C1H2R5CA01#	
0.70pF	±0.05pF	GRM1885C1HR70WA01#				2.6pF	±0.05pF	GRM1885C1H2R6WA01#					
±0.1pF	GRM1885C1HR70BA01#	±0.1pF					GRM1885C1H2R6BA01#						
0.80pF	±0.05pF	GRM1885C1HR80WA01#				±0.25pF	GRM1885C1H2R6CA01#						
±0.1pF	GRM1885C1HR80BA01#	2.7pF				±0.05pF	GRM1885C1H2R7WA01#						
0.90pF	±0.05pF					GRM1885C1HR90WA01#	±0.1pF	GRM1885C1H2R7BA01#					
±0.1pF	GRM1885C1HR90BA01#	±0.25pF				GRM1885C1H2R7CA01#							
1.0pF	±0.05pF	GRM1885C1H1R0WA01#				2.8pF	±0.05pF	GRM1885C1H2R8WA01#					
±0.1pF	GRM1885C1H1R0BA01#	±0.1pF					GRM1885C1H2R8BA01#						
±0.25pF	GRM1885C1H1R0CA01#	±0.25pF				GRM1885C1H2R8CA01#							
1.1pF	±0.05pF	GRM1885C1H1R1WA01#				2.9pF	±0.05pF	GRM1885C1H2R9WA01#					
±0.1pF	GRM1885C1H1R1BA01#	±0.1pF					GRM1885C1H2R9BA01#						
±0.25pF	GRM1885C1H1R1CA01#	±0.25pF				GRM1885C1H2R9CA01#							
1.2pF	±0.05pF	GRM1885C1H1R2WA01#				3.0pF	±0.05pF	GRM1885C1H3R0WA01#					
±0.1pF	GRM1885C1H1R2BA01#	±0.1pF					GRM1885C1H3R0BA01#						
±0.25pF	GRM1885C1H1R2CA01#	±0.25pF				GRM1885C1H3R0CA01#							
1.3pF	±0.05pF	GRM1885C1H1R3WA01#				3.1pF	±0.05pF	GRM1885C1H3R1WA01#					
±0.1pF	GRM1885C1H1R3BA01#	±0.1pF					GRM1885C1H3R1BA01#						
±0.25pF	GRM1885C1H1R3CA01#	±0.25pF				GRM1885C1H3R1CA01#							
1.4pF	±0.05pF	GRM1885C1H1R4WA01#				3.2pF	±0.05pF	GRM1885C1H3R2WA01#					

GRM
 GR3
 GRJ
 GR4
 GR7
 GJM
 GQM
 GA2
 GA3 GB
 GA3 GD
 GA3 GF
 LLL
 LLA
 LLM
 LLR
 NFM
 KRM
 KR3
 GMA
 GMD
 ⚠Caution /Notice

Part number # indicates the package specification code.

GRM Series Temperature Compensating Type Part Number List

(→ 1.6×0.8mm)

T max.	Rated Voltage	TC Code	Cap.	Tol.	Part Number	T max.	Rated Voltage	TC Code	Cap.	Tol.	Part Number
0.9mm	50Vdc	COG	3.2pF	±0.1pF	GRM1885C1H3R2BA01#	0.9mm	50Vdc	COG	5.0pF	±0.1pF	GRM1885C1H5R0BA01#
				±0.25pF	GRM1885C1H3R2CA01#					±0.25pF	GRM1885C1H5R0CA01#
			3.3pF	±0.05pF	GRM1885C1H3R3WA01#	5.1pF			±0.05pF	GRM1885C1H5R1WA01#	
				±0.1pF	GRM1885C1H3R3BA01#				±0.1pF	GRM1885C1H5R1BA01#	
				±0.25pF	GRM1885C1H3R3CA01#				±0.25pF	GRM1885C1H5R1CA01#	
			3.4pF	±0.05pF	GRM1885C1H3R4WA01#	5.2pF			±0.05pF	GRM1885C1H5R2WA01#	
				±0.1pF	GRM1885C1H3R4BA01#				±0.1pF	GRM1885C1H5R2BA01#	
				±0.25pF	GRM1885C1H3R4CA01#				±0.25pF	GRM1885C1H5R2CA01#	
			3.5pF	±0.05pF	GRM1885C1H3R5WA01#	5.3pF			±0.05pF	GRM1885C1H5R3WA01#	
				±0.1pF	GRM1885C1H3R5BA01#				±0.1pF	GRM1885C1H5R3BA01#	
				±0.25pF	GRM1885C1H3R5CA01#				±0.25pF	GRM1885C1H5R3CA01#	
			3.6pF	±0.05pF	GRM1885C1H3R6WA01#	5.4pF			±0.05pF	GRM1885C1H5R4WA01#	
				±0.1pF	GRM1885C1H3R6BA01#				±0.1pF	GRM1885C1H5R4BA01#	
				±0.25pF	GRM1885C1H3R6CA01#				±0.25pF	GRM1885C1H5R4CA01#	
			3.7pF	±0.05pF	GRM1885C1H3R7WA01#	5.5pF			±0.05pF	GRM1885C1H5R5WA01#	
				±0.1pF	GRM1885C1H3R7BA01#				±0.1pF	GRM1885C1H5R5BA01#	
				±0.25pF	GRM1885C1H3R7CA01#				±0.25pF	GRM1885C1H5R5CA01#	
			3.8pF	±0.05pF	GRM1885C1H3R8WA01#	5.6pF			±0.05pF	GRM1885C1H5R6WA01#	
				±0.1pF	GRM1885C1H3R8BA01#				±0.1pF	GRM1885C1H5R6BA01#	
				±0.25pF	GRM1885C1H3R8CA01#				±0.25pF	GRM1885C1H5R6CA01#	
			3.9pF	±0.05pF	GRM1885C1H3R9WA01#	5.7pF			±0.05pF	GRM1885C1H5R7WA01#	
				±0.1pF	GRM1885C1H3R9BA01#				±0.1pF	GRM1885C1H5R7BA01#	
				±0.25pF	GRM1885C1H3R9CA01#				±0.25pF	GRM1885C1H5R7CA01#	
			4.0pF	±0.05pF	GRM1885C1H4R0WA01#	5.8pF			±0.05pF	GRM1885C1H5R8WA01#	
				±0.1pF	GRM1885C1H4R0BA01#				±0.1pF	GRM1885C1H5R8BA01#	
				±0.25pF	GRM1885C1H4R0CA01#				±0.25pF	GRM1885C1H5R8CA01#	
			4.1pF	±0.05pF	GRM1885C1H4R1WA01#	5.9pF			±0.05pF	GRM1885C1H5R9WA01#	
				±0.1pF	GRM1885C1H4R1BA01#				±0.1pF	GRM1885C1H5R9BA01#	
				±0.25pF	GRM1885C1H4R1CA01#				±0.25pF	GRM1885C1H5R9CA01#	
			4.2pF	±0.05pF	GRM1885C1H4R2WA01#	6.0pF			±0.05pF	GRM1885C1H6R0WA01#	
				±0.1pF	GRM1885C1H4R2BA01#				±0.1pF	GRM1885C1H6R0BA01#	
				±0.25pF	GRM1885C1H4R2CA01#				±0.25pF	GRM1885C1H6R0CA01#	
			4.3pF	±0.05pF	GRM1885C1H4R3WA01#	6.1pF			±0.05pF	GRM1885C1H6R1WA01#	
				±0.1pF	GRM1885C1H4R3BA01#				±0.1pF	GRM1885C1H6R1BA01#	
				±0.25pF	GRM1885C1H4R3CA01#				±0.25pF	GRM1885C1H6R1CA01#	
			4.4pF	±0.05pF	GRM1885C1H4R4WA01#	6.2pF			±0.05pF	GRM1885C1H6R2WA01#	
				±0.1pF	GRM1885C1H4R4BA01#				±0.1pF	GRM1885C1H6R2BA01#	
				±0.25pF	GRM1885C1H4R4CA01#				±0.25pF	GRM1885C1H6R2CA01#	
			4.5pF	±0.05pF	GRM1885C1H4R5WA01#	6.3pF			±0.05pF	GRM1885C1H6R3WA01#	
				±0.1pF	GRM1885C1H4R5BA01#				±0.1pF	GRM1885C1H6R3BA01#	
				±0.25pF	GRM1885C1H4R5CA01#				±0.25pF	GRM1885C1H6R3CA01#	
			4.6pF	±0.05pF	GRM1885C1H4R6WA01#	5.0pF			±0.05pF	GRM1885C1H5R0WA01#	
				±0.1pF	GRM1885C1H4R6BA01#				±0.1pF	GRM1885C1H5R0BA01#	
				±0.25pF	GRM1885C1H4R6CA01#				±0.25pF	GRM1885C1H5R0CA01#	
			4.7pF	±0.05pF	GRM1885C1H4R7WA01#						
				±0.1pF	GRM1885C1H4R7BA01#						
				±0.25pF	GRM1885C1H4R7CA01#						
			4.8pF	±0.05pF	GRM1885C1H4R8WA01#						
				±0.1pF	GRM1885C1H4R8BA01#						
				±0.25pF	GRM1885C1H4R8CA01#						
4.9pF	±0.05pF	GRM1885C1H4R9WA01#									
	±0.1pF	GRM1885C1H4R9BA01#									
	±0.25pF	GRM1885C1H4R9CA01#									

Part number # indicates the package specification code.

GRM Series Temperature Compensating Type Part Number List

(→ 1.6×0.8mm)

T max.	Rated Voltage	TC Code	Cap.	Tol.	Part Number	T max.	Rated Voltage	TC Code	Cap.	Tol.	Part Number	
0.9mm	50Vdc	COG	6.4pF	±0.05pF	GRM1885C1H6R4WA01#	0.9mm	50Vdc	COG	7.7pF	±0.25pF	GRM1885C1H7R7CA01#	
				±0.1pF	GRM1885C1H6R4BA01#					±0.5pF	GRM1885C1H7R7DA01#	
				±0.25pF	GRM1885C1H6R4CA01#					7.8pF	±0.05pF	GRM1885C1H7R8WA01#
				±0.5pF	GRM1885C1H6R4DA01#						±0.1pF	GRM1885C1H7R8BA01#
			6.5pF	±0.05pF	GRM1885C1H6R5WA01#				±0.25pF		GRM1885C1H7R8CA01#	
				±0.1pF	GRM1885C1H6R5BA01#				±0.5pF		GRM1885C1H7R8DA01#	
				±0.25pF	GRM1885C1H6R5CA01#				7.9pF	±0.05pF	GRM1885C1H7R9WA01#	
				±0.5pF	GRM1885C1H6R5DA01#					±0.1pF	GRM1885C1H7R9BA01#	
			6.6pF	±0.05pF	GRM1885C1H6R6WA01#					±0.25pF	GRM1885C1H7R9CA01#	
				±0.1pF	GRM1885C1H6R6BA01#					±0.5pF	GRM1885C1H7R9DA01#	
				±0.25pF	GRM1885C1H6R6CA01#				8.0pF	±0.05pF	GRM1885C1H8R0WA01#	
				±0.5pF	GRM1885C1H6R6DA01#					±0.1pF	GRM1885C1H8R0BA01#	
			6.7pF	±0.05pF	GRM1885C1H6R7WA01#					±0.25pF	GRM1885C1H8R0CA01#	
				±0.1pF	GRM1885C1H6R7BA01#					±0.5pF	GRM1885C1H8R0DA01#	
				±0.25pF	GRM1885C1H6R7CA01#				8.1pF	±0.05pF	GRM1885C1H8R1WA01#	
				±0.5pF	GRM1885C1H6R7DA01#					±0.1pF	GRM1885C1H8R1BA01#	
			6.8pF	±0.05pF	GRM1885C1H6R8WA01#					±0.25pF	GRM1885C1H8R1CA01#	
				±0.1pF	GRM1885C1H6R8BA01#					±0.5pF	GRM1885C1H8R1DA01#	
				±0.25pF	GRM1885C1H6R8CA01#				8.2pF	±0.05pF	GRM1885C1H8R2WA01#	
				±0.5pF	GRM1885C1H6R8DA01#					±0.1pF	GRM1885C1H8R2BA01#	
			6.9pF	±0.05pF	GRM1885C1H6R9WA01#					±0.25pF	GRM1885C1H8R2CA01#	
				±0.1pF	GRM1885C1H6R9BA01#					±0.5pF	GRM1885C1H8R2DA01#	
				±0.25pF	GRM1885C1H6R9CA01#				8.3pF	±0.05pF	GRM1885C1H8R3WA01#	
				±0.5pF	GRM1885C1H6R9DA01#					±0.1pF	GRM1885C1H8R3BA01#	
			7.0pF	±0.05pF	GRM1885C1H7R0WA01#					±0.25pF	GRM1885C1H8R3CA01#	
				±0.1pF	GRM1885C1H7R0BA01#					±0.5pF	GRM1885C1H8R3DA01#	
				±0.25pF	GRM1885C1H7R0CA01#				8.4pF	±0.05pF	GRM1885C1H8R4WA01#	
				±0.5pF	GRM1885C1H7R0DA01#					±0.1pF	GRM1885C1H8R4BA01#	
			7.1pF	±0.05pF	GRM1885C1H7R1WA01#					±0.25pF	GRM1885C1H8R4CA01#	
				±0.1pF	GRM1885C1H7R1BA01#					±0.5pF	GRM1885C1H8R4DA01#	
				±0.25pF	GRM1885C1H7R1CA01#				8.5pF	±0.05pF	GRM1885C1H8R5WA01#	
				±0.5pF	GRM1885C1H7R1DA01#					±0.1pF	GRM1885C1H8R5BA01#	
			7.2pF	±0.05pF	GRM1885C1H7R2WA01#					±0.25pF	GRM1885C1H8R5CA01#	
				±0.1pF	GRM1885C1H7R2BA01#					±0.5pF	GRM1885C1H8R5DA01#	
				±0.25pF	GRM1885C1H7R2CA01#				8.6pF	±0.05pF	GRM1885C1H8R6WA01#	
				±0.5pF	GRM1885C1H7R2DA01#					±0.1pF	GRM1885C1H8R6BA01#	
			7.3pF	±0.05pF	GRM1885C1H7R3WA01#					±0.25pF	GRM1885C1H8R6CA01#	
				±0.1pF	GRM1885C1H7R3BA01#					±0.5pF	GRM1885C1H8R6DA01#	
				±0.25pF	GRM1885C1H7R3CA01#				8.7pF	±0.05pF	GRM1885C1H8R7WA01#	
				±0.5pF	GRM1885C1H7R3DA01#					±0.1pF	GRM1885C1H8R7BA01#	
			7.4pF	±0.05pF	GRM1885C1H7R4WA01#					±0.25pF	GRM1885C1H8R7CA01#	
				±0.1pF	GRM1885C1H7R4BA01#					±0.5pF	GRM1885C1H8R7DA01#	
				±0.25pF	GRM1885C1H7R4CA01#				8.8pF	±0.05pF	GRM1885C1H8R8WA01#	
				±0.5pF	GRM1885C1H7R4DA01#					±0.1pF	GRM1885C1H8R8BA01#	
			7.5pF	±0.05pF	GRM1885C1H7R5WA01#					±0.25pF	GRM1885C1H8R8CA01#	
				±0.1pF	GRM1885C1H7R5BA01#					±0.5pF	GRM1885C1H8R8DA01#	
				±0.25pF	GRM1885C1H7R5CA01#				8.9pF	±0.05pF	GRM1885C1H8R9WA01#	
				±0.5pF	GRM1885C1H7R5DA01#					±0.1pF	GRM1885C1H8R9BA01#	
			7.6pF	±0.05pF	GRM1885C1H7R6WA01#					±0.25pF	GRM1885C1H8R9CA01#	
				±0.1pF	GRM1885C1H7R6BA01#					±0.5pF	GRM1885C1H8R9DA01#	
				±0.25pF	GRM1885C1H7R6CA01#				9.0pF	±0.05pF	GRM1885C1H9R0WA01#	
				±0.5pF	GRM1885C1H7R6DA01#					±0.1pF	GRM1885C1H9R0BA01#	
			7.7pF	±0.05pF	GRM1885C1H7R7WA01#					±0.25pF	GRM1885C1H9R0CA01#	
				±0.1pF	GRM1885C1H7R7BA01#					±0.5pF	GRM1885C1H9R0DA01#	

- GRM
- GR3
- GRJ
- GR4
- GR7
- GJM
- GQM
- GA2
- GA3 GB
- GA3 GD
- GA3 GF
- LLL
- LLA
- LLM
- LLR
- NFM
- KRM
- KR3
- GMA
- GMD
- ⚠Caution /Notice

Part number # indicates the package specification code.

GRM Series Temperature Compensating Type Part Number List

(→ 1.6×0.8mm)

T max.	Rated Voltage	TC Code	Cap.	Tol.	Part Number	T max.	Rated Voltage	TC Code	Cap.	Tol.	Part Number	
0.9mm	50Vdc	COG	9.1pF	±0.05pF	GRM1885C1H9R1WA01#	0.9mm	50Vdc	COG	330pF	±5%	GRM1885C1H331JA01#	
				±0.1pF	GRM1885C1H9R1BA01#					390pF	±5%	GRM1885C1H391JA01#
				±0.25pF	GRM1885C1H9R1CA01#					470pF	±5%	GRM1885C1H471JA01#
				±0.5pF	GRM1885C1H9R1DA01#					560pF	±5%	GRM1885C1H561JA01#
			9.2pF	±0.05pF	GRM1885C1H9R2WA01#				680pF	±5%	GRM1885C1H681JA01#	
				±0.1pF	GRM1885C1H9R2BA01#				820pF	±5%	GRM1885C1H821JA01#	
				±0.25pF	GRM1885C1H9R2CA01#				1000pF	±5%	GRM1885C1H102JA01#	
				±0.5pF	GRM1885C1H9R2DA01#				1200pF	±5%	GRM1885C1H122JA01#	
			9.3pF	±0.05pF	GRM1885C1H9R3WA01#				1500pF	±5%	GRM1885C1H152JA01#	
				±0.1pF	GRM1885C1H9R3BA01#				1800pF	±5%	GRM1885C1H182JA01#	
				±0.25pF	GRM1885C1H9R3CA01#				2200pF	±5%	GRM1885C1H222JA01#	
				±0.5pF	GRM1885C1H9R3DA01#				2700pF	±5%	GRM1885C1H272JA01#	
			9.4pF	±0.05pF	GRM1885C1H9R4WA01#				3300pF	±5%	GRM1885C1H332JA01#	
				±0.1pF	GRM1885C1H9R4BA01#				3900pF	±5%	GRM1885C1H392JA01#	
				±0.25pF	GRM1885C1H9R4CA01#				4700pF	±5%	GRM1885C1H472JA01#	
				±0.5pF	GRM1885C1H9R4DA01#				5600pF	±5%	GRM1885C1H562JA01#	
			9.5pF	±0.05pF	GRM1885C1H9R5WA01#				6800pF	±5%	GRM1885C1H682JA01#	
				±0.1pF	GRM1885C1H9R5BA01#				8200pF	±5%	GRM1885C1H822JA01#	
				±0.25pF	GRM1885C1H9R5CA01#				10000pF	±5%	GRM1885C1H103JA01#	
				±0.5pF	GRM1885C1H9R5DA01#				CK	0.50pF	±0.05pF	GRM1884C1HR50WA01#
			9.6pF	±0.05pF	GRM1885C1H9R6WA01#					±0.1pF	GRM1884C1HR50BA01#	
				±0.1pF	GRM1885C1H9R6BA01#					0.60pF	±0.05pF	GRM1884C1HR60WA01#
				±0.25pF	GRM1885C1H9R6CA01#					±0.1pF	GRM1884C1HR60BA01#	
				±0.5pF	GRM1885C1H9R6DA01#				0.70pF	±0.05pF	GRM1884C1HR70WA01#	
			9.7pF	±0.05pF	GRM1885C1H9R7WA01#				±0.1pF	GRM1884C1HR70BA01#		
				±0.1pF	GRM1885C1H9R7BA01#				0.80pF	±0.05pF	GRM1884C1HR80WA01#	
				±0.25pF	GRM1885C1H9R7CA01#				±0.1pF	GRM1884C1HR80BA01#		
				±0.5pF	GRM1885C1H9R7DA01#				0.90pF	±0.05pF	GRM1884C1HR90WA01#	
			9.8pF	±0.05pF	GRM1885C1H9R8WA01#				±0.1pF	GRM1884C1HR90BA01#		
				±0.1pF	GRM1885C1H9R8BA01#				1.0pF	±0.05pF	GRM1884C1H1R0WA01#	
				±0.25pF	GRM1885C1H9R8CA01#				±0.1pF	GRM1884C1H1R0BA01#		
				±0.5pF	GRM1885C1H9R8DA01#				±0.25pF	GRM1884C1H1R0CA01#		
			9.9pF	±0.05pF	GRM1885C1H9R9WA01#				1.1pF	±0.05pF	GRM1884C1H1R1WA01#	
				±0.1pF	GRM1885C1H9R9BA01#				±0.1pF	GRM1884C1H1R1BA01#		
				±0.25pF	GRM1885C1H9R9CA01#				±0.25pF	GRM1884C1H1R1CA01#		
				±0.5pF	GRM1885C1H9R9DA01#				1.2pF	±0.05pF	GRM1884C1H1R2WA01#	
			10pF	±5%	GRM1885C1H100JA01#				±0.1pF	GRM1884C1H1R2BA01#		
			12pF	±5%	GRM1885C1H120JA01#				±0.25pF	GRM1884C1H1R2CA01#		
			15pF	±5%	GRM1885C1H150JA01#				1.3pF	±0.05pF	GRM1884C1H1R3WA01#	
			18pF	±5%	GRM1885C1H180JA01#					±0.1pF	GRM1884C1H1R3BA01#	
			22pF	±5%	GRM1885C1H220JA01#					±0.25pF	GRM1884C1H1R3CA01#	
			27pF	±5%	GRM1885C1H270JA01#				1.4pF	±0.05pF	GRM1884C1H1R4WA01#	
			33pF	±5%	GRM1885C1H330JA01#					±0.1pF	GRM1884C1H1R4BA01#	
			39pF	±5%	GRM1885C1H390JA01#					±0.25pF	GRM1884C1H1R4CA01#	
47pF	±5%	GRM1885C1H470JA01#	1.5pF	±0.05pF	GRM1884C1H1R5WA01#							
56pF	±5%	GRM1885C1H560JA01#		±0.1pF	GRM1884C1H1R5BA01#							
68pF	±5%	GRM1885C1H680JA01#		±0.25pF	GRM1884C1H1R5CA01#							
82pF	±5%	GRM1885C1H820JA01#	1.6pF	±0.05pF	GRM1884C1H1R6WA01#							
100pF	±5%	GRM1885C1H101JA01#		±0.1pF	GRM1884C1H1R6BA01#							
120pF	±5%	GRM1885C1H121JA01#		±0.25pF	GRM1884C1H1R6CA01#							
150pF	±5%	GRM1885C1H151JA01#	1.7pF	±0.05pF	GRM1884C1H1R7WA01#							
180pF	±5%	GRM1885C1H181JA01#		±0.1pF	GRM1884C1H1R7BA01#							
220pF	±5%	GRM1885C1H221JA01#		±0.25pF	GRM1884C1H1R7CA01#							
270pF	±5%	GRM1885C1H271JA01#	1.8pF	±0.05pF	GRM1884C1H1R8WA01#							

Part number # indicates the package specification code.



GRM Series Temperature Compensating Type Part Number List

(→ 1.6×0.8mm)

T max.	Rated Voltage	TC Code	Cap.	Tol.	Part Number	T max.	Rated Voltage	TC Code	Cap.	Tol.	Part Number		
0.9mm	50Vdc	CK	1.8pF	±0.1pF	GRM1884C1H1R8BA01#	0.9mm	50Vdc	CJ	3.6pF	±0.1pF	GRM1883C1H3R6BA01#		
				±0.25pF	GRM1884C1H1R8CA01#					±0.25pF	GRM1883C1H3R6CA01#		
				1.9pF	±0.05pF					GRM1884C1H1R9WA01#	3.7pF	±0.05pF	GRM1883C1H3R7WA01#
			±0.1pF		GRM1884C1H1R9BA01#					±0.1pF		GRM1883C1H3R7BA01#	
			±0.25pF		GRM1884C1H1R9CA01#					±0.25pF		GRM1883C1H3R7CA01#	
			2.0pF	±0.05pF	GRM1884C1H2R0WA01#					3.8pF	±0.05pF	GRM1883C1H3R8WA01#	
				±0.1pF	GRM1884C1H2R0BA01#				±0.1pF		GRM1883C1H3R8BA01#		
				±0.25pF	GRM1884C1H2R0CA01#				±0.25pF		GRM1883C1H3R8CA01#		
			CJ	2.1pF	±0.05pF				GRM1883C1H2R1WA01#	3.9pF	±0.05pF	GRM1883C1H3R9WA01#	
					±0.1pF				GRM1883C1H2R1BA01#		±0.1pF	GRM1883C1H3R9BA01#	
					±0.25pF				GRM1883C1H2R1CA01#		±0.25pF	GRM1883C1H3R9CA01#	
				2.2pF	±0.05pF				GRM1883C1H2R2WA01#	CH	4.0pF	±0.05pF	GRM1882C1H4R0WA01#
					±0.1pF				GRM1883C1H2R2BA01#			±0.1pF	GRM1882C1H4R0BA01#
					±0.25pF				GRM1883C1H2R2CA01#			±0.25pF	GRM1882C1H4R0CA01#
				2.3pF	±0.05pF				GRM1883C1H2R3WA01#	4.1pF	±0.05pF	GRM1882C1H4R1WA01#	
					±0.1pF				GRM1883C1H2R3BA01#		±0.1pF	GRM1882C1H4R1BA01#	
					±0.25pF				GRM1883C1H2R3CA01#		±0.25pF	GRM1882C1H4R1CA01#	
				2.4pF	±0.05pF				GRM1883C1H2R4WA01#	4.2pF	±0.05pF	GRM1882C1H4R2WA01#	
					±0.1pF				GRM1883C1H2R4BA01#		±0.1pF	GRM1882C1H4R2BA01#	
					±0.25pF				GRM1883C1H2R4CA01#		±0.25pF	GRM1882C1H4R2CA01#	
				2.5pF	±0.05pF				GRM1883C1H2R5WA01#	4.3pF	±0.05pF	GRM1882C1H4R3WA01#	
					±0.1pF				GRM1883C1H2R5BA01#		±0.1pF	GRM1882C1H4R3BA01#	
					±0.25pF				GRM1883C1H2R5CA01#		±0.25pF	GRM1882C1H4R3CA01#	
				2.6pF	±0.05pF				GRM1883C1H2R6WA01#	4.4pF	±0.05pF	GRM1882C1H4R4WA01#	
		±0.1pF			GRM1883C1H2R6BA01#	±0.1pF	GRM1882C1H4R4BA01#						
		±0.25pF			GRM1883C1H2R6CA01#	±0.25pF	GRM1882C1H4R4CA01#						
		2.7pF		±0.05pF	GRM1883C1H2R7WA01#	4.5pF	±0.05pF	GRM1882C1H4R5WA01#					
				±0.1pF	GRM1883C1H2R7BA01#		±0.1pF	GRM1882C1H4R5BA01#					
				±0.25pF	GRM1883C1H2R7CA01#		±0.25pF	GRM1882C1H4R5CA01#					
		2.8pF		±0.05pF	GRM1883C1H2R8WA01#	4.6pF	±0.05pF	GRM1882C1H4R6WA01#					
				±0.1pF	GRM1883C1H2R8BA01#		±0.1pF	GRM1882C1H4R6BA01#					
				±0.25pF	GRM1883C1H2R8CA01#		±0.25pF	GRM1882C1H4R6CA01#					
		2.9pF	±0.05pF	GRM1883C1H2R9WA01#	4.7pF	±0.05pF	GRM1882C1H4R7WA01#						
			±0.1pF	GRM1883C1H2R9BA01#		±0.1pF	GRM1882C1H4R7BA01#						
			±0.25pF	GRM1883C1H2R9CA01#		±0.25pF	GRM1882C1H4R7CA01#						
		3.0pF	±0.05pF	GRM1883C1H3R0WA01#	4.8pF	±0.05pF	GRM1882C1H4R8WA01#						
			±0.1pF	GRM1883C1H3R0BA01#		±0.1pF	GRM1882C1H4R8BA01#						
			±0.25pF	GRM1883C1H3R0CA01#		±0.25pF	GRM1882C1H4R8CA01#						
		3.1pF	±0.05pF	GRM1883C1H3R1WA01#	4.9pF	±0.05pF	GRM1882C1H4R9WA01#						
			±0.1pF	GRM1883C1H3R1BA01#		±0.1pF	GRM1882C1H4R9BA01#						
			±0.25pF	GRM1883C1H3R1CA01#		±0.25pF	GRM1882C1H4R9CA01#						
		3.2pF	±0.05pF	GRM1883C1H3R2WA01#	5.0pF	±0.05pF	GRM1882C1H5R0WA01#						
			±0.1pF	GRM1883C1H3R2BA01#		±0.1pF	GRM1882C1H5R0BA01#						
			±0.25pF	GRM1883C1H3R2CA01#		±0.25pF	GRM1882C1H5R0CA01#						
		3.3pF	±0.05pF	GRM1883C1H3R3WA01#	5.1pF	±0.05pF	GRM1882C1H5R1WA01#						
			±0.1pF	GRM1883C1H3R3BA01#		±0.1pF	GRM1882C1H5R1BA01#						
			±0.25pF	GRM1883C1H3R3CA01#		±0.25pF	GRM1882C1H5R1CA01#						
		3.4pF	±0.05pF	GRM1883C1H3R4WA01#	5.2pF	±0.05pF	GRM1882C1H5R2WA01#						
±0.1pF	GRM1883C1H3R4BA01#		±0.1pF	GRM1882C1H5R2BA01#									
±0.25pF	GRM1883C1H3R4CA01#		±0.25pF	GRM1882C1H5R2CA01#									
3.5pF	±0.05pF	GRM1883C1H3R5WA01#	5.3pF	±0.05pF	GRM1882C1H5R3WA01#								
	±0.1pF	GRM1883C1H3R5BA01#		±0.1pF	GRM1882C1H5R3BA01#								
	±0.25pF	GRM1883C1H3R5CA01#		±0.25pF	GRM1882C1H5R3CA01#								
3.6pF	±0.05pF	GRM1883C1H3R6WA01#											

GRM
 GR3
 GRJ
 GR4
 GR7
 GJM
 GQM
 GA2
 GA3 GB
 GA3 GD
 GA3 GF
 LLL
 LLA
 LLM
 LLR
 NFM
 KRM
 KR3
 GMA
 GMD
 ⚠Caution / Notice

Part number # indicates the package specification code.

GRM Series Temperature Compensating Type Part Number List

(→ 1.6×0.8mm)

T max.	Rated Voltage	TC Code	Cap.	Tol.	Part Number	T max.	Rated Voltage	TC Code	Cap.	Tol.	Part Number
0.9mm	50Vdc	CH	5.3pF	±0.25pF	GRM1882C1H5R3CA01#	0.9mm	50Vdc	CH	6.7pF	±0.05pF	GRM1882C1H6R7WA01#
				±0.5pF	GRM1882C1H5R3DA01#					±0.1pF	GRM1882C1H6R7BA01#
			5.4pF	±0.05pF	GRM1882C1H5R4WA01#	±0.25pF			GRM1882C1H6R7CA01#		
				±0.1pF	GRM1882C1H5R4BA01#	±0.5pF			GRM1882C1H6R7DA01#		
				±0.25pF	GRM1882C1H5R4CA01#	6.8pF			±0.05pF	GRM1882C1H6R8WA01#	
				±0.5pF	GRM1882C1H5R4DA01#				±0.1pF	GRM1882C1H6R8BA01#	
			5.5pF	±0.05pF	GRM1882C1H5R5WA01#				±0.25pF	GRM1882C1H6R8CA01#	
				±0.1pF	GRM1882C1H5R5BA01#	±0.5pF			GRM1882C1H6R8DA01#		
			±0.25pF	GRM1882C1H5R5CA01#	6.9pF	±0.05pF			GRM1882C1H6R9WA01#		
				±0.5pF		GRM1882C1H5R5DA01#			±0.1pF	GRM1882C1H6R9BA01#	
				5.6pF		±0.05pF			GRM1882C1H5R6WA01#	±0.25pF	GRM1882C1H6R9CA01#
			±0.1pF		GRM1882C1H5R6BA01#	±0.5pF			GRM1882C1H6R9DA01#		
			±0.25pF		GRM1882C1H5R6CA01#	7.0pF			±0.05pF	GRM1882C1H7R0WA01#	
			±0.5pF	GRM1882C1H5R6DA01#	±0.1pF				GRM1882C1H7R0BA01#		
			5.7pF	±0.05pF	GRM1882C1H5R7WA01#				±0.25pF	GRM1882C1H7R0CA01#	
				±0.1pF	GRM1882C1H5R7BA01#	±0.5pF			GRM1882C1H7R0DA01#		
				±0.25pF	GRM1882C1H5R7CA01#	7.1pF			±0.05pF	GRM1882C1H7R1WA01#	
				±0.5pF	GRM1882C1H5R7DA01#				±0.1pF	GRM1882C1H7R1BA01#	
			5.8pF	±0.05pF	GRM1882C1H5R8WA01#				±0.25pF	GRM1882C1H7R1CA01#	
				±0.1pF	GRM1882C1H5R8BA01#	±0.5pF			GRM1882C1H7R1DA01#		
				±0.25pF	GRM1882C1H5R8CA01#	7.2pF			±0.05pF	GRM1882C1H7R2WA01#	
			±0.5pF	GRM1882C1H5R8DA01#	±0.1pF				GRM1882C1H7R2BA01#		
			5.9pF	±0.05pF	GRM1882C1H5R9WA01#				±0.25pF	GRM1882C1H7R2CA01#	
				±0.1pF	GRM1882C1H5R9BA01#	±0.5pF			GRM1882C1H7R2DA01#		
				±0.25pF	GRM1882C1H5R9CA01#	7.3pF			±0.05pF	GRM1882C1H7R3WA01#	
				±0.5pF	GRM1882C1H5R9DA01#				±0.1pF	GRM1882C1H7R3BA01#	
			6.0pF	±0.05pF	GRM1882C1H6R0WA01#				±0.25pF	GRM1882C1H7R3CA01#	
				±0.1pF	GRM1882C1H6R0BA01#	±0.5pF			GRM1882C1H7R3DA01#		
				±0.25pF	GRM1882C1H6R0CA01#	7.4pF			±0.05pF	GRM1882C1H7R4WA01#	
				±0.5pF	GRM1882C1H6R0DA01#				±0.1pF	GRM1882C1H7R4BA01#	
			6.1pF	±0.05pF	GRM1882C1H6R1WA01#				±0.25pF	GRM1882C1H7R4CA01#	
				±0.1pF	GRM1882C1H6R1BA01#	±0.5pF			GRM1882C1H7R4DA01#		
				±0.25pF	GRM1882C1H6R1CA01#	7.5pF			±0.05pF	GRM1882C1H7R5WA01#	
				±0.5pF	GRM1882C1H6R1DA01#				±0.1pF	GRM1882C1H7R5BA01#	
			6.2pF	±0.05pF	GRM1882C1H6R2WA01#				±0.25pF	GRM1882C1H7R5CA01#	
				±0.1pF	GRM1882C1H6R2BA01#	±0.5pF			GRM1882C1H7R5DA01#		
				±0.25pF	GRM1882C1H6R2CA01#	7.6pF			±0.05pF	GRM1882C1H7R6WA01#	
				±0.5pF	GRM1882C1H6R2DA01#				±0.1pF	GRM1882C1H7R6BA01#	
			6.3pF	±0.05pF	GRM1882C1H6R3WA01#				±0.25pF	GRM1882C1H7R6CA01#	
				±0.1pF	GRM1882C1H6R3BA01#	±0.5pF			GRM1882C1H7R6DA01#		
				±0.25pF	GRM1882C1H6R3CA01#	7.7pF			±0.05pF	GRM1882C1H7R7WA01#	
				±0.5pF	GRM1882C1H6R3DA01#				±0.1pF	GRM1882C1H7R7BA01#	
			6.4pF	±0.05pF	GRM1882C1H6R4WA01#				±0.25pF	GRM1882C1H7R7CA01#	
				±0.1pF	GRM1882C1H6R4BA01#	±0.5pF			GRM1882C1H7R7DA01#		
				±0.25pF	GRM1882C1H6R4CA01#	7.8pF			±0.05pF	GRM1882C1H7R8WA01#	
				±0.5pF	GRM1882C1H6R4DA01#				±0.1pF	GRM1882C1H7R8BA01#	
			6.5pF	±0.05pF	GRM1882C1H6R5WA01#				±0.25pF	GRM1882C1H7R8CA01#	
				±0.1pF	GRM1882C1H6R5BA01#	±0.5pF			GRM1882C1H7R8DA01#		
				±0.25pF	GRM1882C1H6R5CA01#	7.9pF			±0.05pF	GRM1882C1H7R9WA01#	
				±0.5pF	GRM1882C1H6R5DA01#				±0.1pF	GRM1882C1H7R9BA01#	
			6.6pF	±0.05pF	GRM1882C1H6R6WA01#				±0.25pF	GRM1882C1H7R9CA01#	
				±0.1pF	GRM1882C1H6R6BA01#	±0.5pF			GRM1882C1H7R9DA01#		
				±0.25pF	GRM1882C1H6R6CA01#	8.0pF			±0.05pF	GRM1882C1H8R0WA01#	
				±0.5pF	GRM1882C1H6R6DA01#				±0.1pF	GRM1882C1H8R0BA01#	

Part number # indicates the package specification code.



GRM Series Temperature Compensating Type Part Number List

(→ 1.6×0.8mm)

T max.	Rated Voltage	TC Code	Cap.	Tol.	Part Number	T max.	Rated Voltage	TC Code	Cap.	Tol.	Part Number
0.9mm	50Vdc	CH	8.0pF	±0.25pF	GRM1882C1H8R0CA01#	0.9mm	50Vdc	CH	9.4pF	±0.05pF	GRM1882C1H9R4WA01#
				±0.5pF	GRM1882C1H8R0DA01#					±0.1pF	GRM1882C1H9R4BA01#
			8.1pF	±0.05pF	GRM1882C1H8R1WA01#	±0.25pF	GRM1882C1H9R4CA01#				
				±0.1pF	GRM1882C1H8R1BA01#	±0.5pF	GRM1882C1H9R4DA01#				
				±0.25pF	GRM1882C1H8R1CA01#	9.5pF	±0.05pF	GRM1882C1H9R5WA01#			
				±0.5pF	GRM1882C1H8R1DA01#		±0.1pF	GRM1882C1H9R5BA01#			
			8.2pF	±0.05pF	GRM1882C1H8R2WA01#	±0.25pF	GRM1882C1H9R5CA01#				
				±0.1pF	GRM1882C1H8R2BA01#	±0.5pF	GRM1882C1H9R5DA01#				
				±0.25pF	GRM1882C1H8R2CA01#	9.6pF	±0.05pF	GRM1882C1H9R6WA01#			
				±0.5pF	GRM1882C1H8R2DA01#		±0.1pF	GRM1882C1H9R6BA01#			
			8.3pF	±0.05pF	GRM1882C1H8R3WA01#	±0.25pF	GRM1882C1H9R6CA01#				
				±0.1pF	GRM1882C1H8R3BA01#	±0.5pF	GRM1882C1H9R6DA01#				
				±0.25pF	GRM1882C1H8R3CA01#	9.7pF	±0.05pF	GRM1882C1H9R7WA01#			
				±0.5pF	GRM1882C1H8R3DA01#		±0.1pF	GRM1882C1H9R7BA01#			
			8.4pF	±0.05pF	GRM1882C1H8R4WA01#	±0.25pF	GRM1882C1H9R7CA01#				
				±0.1pF	GRM1882C1H8R4BA01#	±0.5pF	GRM1882C1H9R7DA01#				
				±0.25pF	GRM1882C1H8R4CA01#	9.8pF	±0.05pF	GRM1882C1H9R8WA01#			
				±0.5pF	GRM1882C1H8R4DA01#		±0.1pF	GRM1882C1H9R8BA01#			
			8.5pF	±0.05pF	GRM1882C1H8R5WA01#	±0.25pF	GRM1882C1H9R8CA01#				
				±0.1pF	GRM1882C1H8R5BA01#	±0.5pF	GRM1882C1H9R8DA01#				
				±0.25pF	GRM1882C1H8R5CA01#	9.9pF	±0.05pF	GRM1882C1H9R9WA01#			
				±0.5pF	GRM1882C1H8R5DA01#		±0.1pF	GRM1882C1H9R9BA01#			
			8.6pF	±0.05pF	GRM1882C1H8R6WA01#	±0.25pF	GRM1882C1H9R9CA01#				
				±0.1pF	GRM1882C1H8R6BA01#	±0.5pF	GRM1882C1H9R9DA01#				
				±0.25pF	GRM1882C1H8R6CA01#	10pF	±5%	GRM1882C1H100JA01#			
				±0.5pF	GRM1882C1H8R6DA01#		12pF	±5%	GRM1882C1H120JA01#		
			8.7pF	±0.05pF	GRM1882C1H8R7WA01#	15pF	±5%	GRM1882C1H150JA01#			
				±0.1pF	GRM1882C1H8R7BA01#	18pF	±5%	GRM1882C1H180JA01#			
				±0.25pF	GRM1882C1H8R7CA01#	22pF	±5%	GRM1882C1H220JA01#			
				±0.5pF	GRM1882C1H8R7DA01#	27pF	±5%	GRM1882C1H270JA01#			
			8.8pF	±0.05pF	GRM1882C1H8R8WA01#	33pF	±5%	GRM1882C1H330JA01#			
				±0.1pF	GRM1882C1H8R8BA01#	39pF	±5%	GRM1882C1H390JA01#			
				±0.25pF	GRM1882C1H8R8CA01#	47pF	±5%	GRM1882C1H470JA01#			
				±0.5pF	GRM1882C1H8R8DA01#	56pF	±5%	GRM1882C1H560JA01#			
			8.9pF	±0.05pF	GRM1882C1H8R9WA01#	68pF	±5%	GRM1882C1H680JA01#			
				±0.1pF	GRM1882C1H8R9BA01#	82pF	±5%	GRM1882C1H820JA01#			
				±0.25pF	GRM1882C1H8R9CA01#	100pF	±5%	GRM1882C1H101JA01#			
				±0.5pF	GRM1882C1H8R9DA01#	120pF	±5%	GRM1882C1H121JA01#			
			9.0pF	±0.05pF	GRM1882C1H9R0WA01#	150pF	±5%	GRM1882C1H151JA01#			
				±0.1pF	GRM1882C1H9R0BA01#	180pF	±5%	GRM1882C1H181JA01#			
				±0.25pF	GRM1882C1H9R0CA01#	220pF	±5%	GRM1882C1H221JA01#			
				±0.5pF	GRM1882C1H9R0DA01#	270pF	±5%	GRM1882C1H271JA01#			
			9.1pF	±0.05pF	GRM1882C1H9R1WA01#	330pF	±5%	GRM1882C1H331JA01#			
				±0.1pF	GRM1882C1H9R1BA01#	390pF	±5%	GRM1882C1H391JA01#			
				±0.25pF	GRM1882C1H9R1CA01#	470pF	±5%	GRM1882C1H471JA01#			
				±0.5pF	GRM1882C1H9R1DA01#	560pF	±5%	GRM1882C1H561JA01#			
			9.2pF	±0.05pF	GRM1882C1H9R2WA01#	680pF	±5%	GRM1882C1H681JA01#			
				±0.1pF	GRM1882C1H9R2BA01#	820pF	±5%	GRM1882C1H821JA01#			
				±0.25pF	GRM1882C1H9R2CA01#	1000pF	±5%	GRM1882C1H102JA01#			
				±0.5pF	GRM1882C1H9R2DA01#	1200pF	±5%	GRM1882C1H122JA01#			
			9.3pF	±0.05pF	GRM1882C1H9R3WA01#	1500pF	±5%	GRM1882C1H152JA01#			
				±0.1pF	GRM1882C1H9R3BA01#	1800pF	±5%	GRM1882C1H182JA01#			
				±0.25pF	GRM1882C1H9R3CA01#	2200pF	±5%	GRM1882C1H222JA01#			
				±0.5pF	GRM1882C1H9R3DA01#	2700pF	±5%	GRM1882C1H272JA01#			

GRM
 GR3
 GRJ
 GR4
 GR7
 GJM
 GQM
 GA2
 GA3 GB
 GA3 GD
 GA3 GF
 LLL
 LLA
 LLM
 LLR
 NFM
 KRM
 KR3
 GMA
 GMD
 ⚠Caution /Notice

Part number # indicates the package specification code.

GRM Series Temperature Compensating Type Part Number List

(→ 1.6×0.8mm)

T max.	Rated Voltage	TC Code	Cap.	Tol.	Part Number				
0.9mm	50Vdc	CH	3300pF	±5%	GRM1882C1H332JA01#				
			3900pF	±5%	GRM1882C1H392JA01#				
			4700pF	±5%	GRM1882C1H472JA01#				
			5600pF	±5%	GRM1882C1H562JA01#				
			6800pF	±5%	GRM1882C1H682JA01#				
			8200pF	±5%	GRM1882C1H822JA01#				
			10000pF	±5%	GRM1882C1H103JA01#				
0.9mm	50Vdc	SL	1200pF	±5%	GRM1881X1H122JA01#				
			1500pF	±5%	GRM1881X1H152JA01#				
			1800pF	±5%	GRM1881X1H182JA01#				
			2200pF	±5%	GRM1881X1H222JA01#				
			2700pF	±5%	GRM1881X1H272JA01#				
			3300pF	±5%	GRM1881X1H332JA01#				
			3900pF	±5%	GRM1881X1H392JA01#				
			4700pF	±5%	GRM1881X1H472JA01#				
			5600pF	±5%	GRM1881X1H562JA01#				
			6800pF	±5%	GRM1881X1H682JA01#				
			8200pF	±5%	GRM1881X1H822JA01#				
		10000pF	±5%	GRM1881X1H103JA01#					
		U2J	1200pF	±5%	GRM1887U1H122JA01#				
			1500pF	±5%	GRM1887U1H152JA01#				
			1800pF	±5%	GRM1887U1H182JA01#				
			2200pF	±5%	GRM1887U1H222JA01#				
			2700pF	±5%	GRM1887U1H272JA01#				
			3300pF	±5%	GRM1887U1H332JA01#				
			3900pF	±5%	GRM1887U1H392JA01#				
			4700pF	±5%	GRM1887U1H472JA01#				
			5600pF	±5%	GRM1887U1H562JA01#				
6800pF	±5%		GRM1887U1H682JA01#						
8200pF	±5%	GRM1887U1H822JA01#							
10000pF	±5%	GRM1887U1H103JA01#							
UJ	50Vdc	UJ	1000pF	±5%	GRM1883U1H102JA01#				
			1200pF	±5%	GRM1883U1H122JA01#				
			1500pF	±5%	GRM1883U1H152JA01#				
			1800pF	±5%	GRM1883U1H182JA01#				
			2200pF	±5%	GRM1883U1H222JA01#				
			2700pF	±5%	GRM1883U1H272JA01#				
			3300pF	±5%	GRM1883U1H332JA01#				
			3900pF	±5%	GRM1883U1H392JA01#				
			4700pF	±5%	GRM1883U1H472JA01#				
			5600pF	±5%	GRM1883U1H562JA01#				
			6800pF	±5%	GRM1883U1H682JA01#				
			8200pF	±5%	GRM1883U1H822JA01#				
			10000pF	±5%	GRM1883U1H103JA01#				
			SL	10Vdc	SL	12000pF	±5%	GRM1881X1A123JA01#	
						15000pF	±5%	GRM1881X1A153JA01#	
						18000pF	±5%	GRM1881X1A183JA01#	
						22000pF	±5%	GRM1881X1A223JA01#	
						U2J	12000pF	±5%	GRM1887U1A123JA01#
							15000pF	±5%	GRM1887U1A153JA01#
18000pF	±5%	GRM1887U1A183JA01#							
22000pF	±5%	GRM1887U1A223JA01#							
UJ	12000pF	±5%	GRM1883U1A123JA01#						
	15000pF	±5%	GRM1883U1A153JA01#						

T max.	Rated Voltage	TC Code	Cap.	Tol.	Part Number
0.9mm	10Vdc	UJ	18000pF	±5%	GRM1883U1A183JA01#
			22000pF	±5%	GRM1883U1A223JA01#

2.0×1.25mm

T max.	Rated Voltage	TC Code	Cap.	Tol.	Part Number		
0.7mm	100Vdc	COG	100pF	±5%	GRM2165C2A101JA01#		
			120pF	±5%	GRM2165C2A121JA01#		
			150pF	±5%	GRM2165C2A151JA01#		
			180pF	±5%	GRM2165C2A181JA01#		
			220pF	±5%	GRM2165C2A221JA01#		
			270pF	±5%	GRM2165C2A271JA01#		
			330pF	±5%	GRM2165C2A331JA01#		
			390pF	±5%	GRM2165C2A391JA01#		
			470pF	±5%	GRM2165C2A471JA01#		
			560pF	±5%	GRM2165C2A561JA01#		
			680pF	±5%	GRM2165C2A681JA01#		
			820pF	±5%	GRM2165C2A821JA01#		
			1000pF	±5%	GRM2165C2A102JA01#		
			1200pF	±5%	GRM2165C2A122JA01#		
			1500pF	±5%	GRM2165C2A152JA01#		
			1800pF	±5%	GRM2165C2A182JA01#		
			2200pF	±5%	GRM2165C2A222JA01#		
			2700pF	±5%	GRM2165C2A272JA01#		
			3300pF	±5%	GRM2165C2A332JA01#		
			CH	100pF	±5%	GRM2162C2A101JA01#	
				120pF	±5%	GRM2162C2A121JA01#	
		150pF		±5%	GRM2162C2A151JA01#		
		180pF		±5%	GRM2162C2A181JA01#		
		220pF		±5%	GRM2162C2A221JA01#		
		270pF		±5%	GRM2162C2A271JA01#		
		330pF		±5%	GRM2162C2A331JA01#		
		390pF		±5%	GRM2162C2A391JA01#		
		470pF		±5%	GRM2162C2A471JA01#		
		560pF		±5%	GRM2162C2A561JA01#		
		680pF		±5%	GRM2162C2A681JA01#		
		820pF		±5%	GRM2162C2A821JA01#		
		COG	50Vdc	COG	1200pF	±5%	GRM2165C1H122JA01#
					1500pF	±5%	GRM2165C1H152JA01#
1800pF	±5%				GRM2165C1H182JA01#		
2200pF	±5%				GRM2165C1H222JA01#		
2700pF	±5%				GRM2165C1H272JA01#		
3300pF	±5%				GRM2165C1H332JA01#		
3900pF	±5%				GRM2165C1H392JA01#		
4700pF	±5%				GRM2165C1H472JA01#		
CH	1200pF				±5%	GRM2162C1H122JA01#	

Part number # indicates the package specification code.

GRM Series Temperature Compensating Type Part Number List

(→ 2.0×1.25mm)

T max.	Rated Voltage	TC Code	Cap.	Tol.	Part Number	T max.	Rated Voltage	TC Code	Cap.	Tol.	Part Number		
0.7mm	50Vdc	CH	1500pF	±5%	GRM2162C1H152JA01#	1.0mm	630Vdc	COG	220pF	±5%	GRM21A5C2J221JWA1#		
			1800pF	±5%	GRM2162C1H182JA01#				270pF	±5%	GRM21A5C2J271JWA1#		
			2200pF	±5%	GRM2162C1H222JA01#				330pF	±5%	GRM21A5C2J331JWA1#		
			2700pF	±5%	GRM2162C1H272JA01#				390pF	±5%	GRM21A5C2J391JWA1#		
			3300pF	±5%	GRM2162C1H332JA01#				470pF	±5%	GRM21A5C2J471JWA1#		
			3900pF	±5%	GRM2162C1H392JA01#				560pF	±5%	GRM21A5C2J561JWA1#		
			4700pF	±5%	GRM2162C1H472JA01#				250Vdc	COG	10pF	±5%	GRM21A5C2E100JW01#
			SL	12000pF	±5%						GRM2161X1H123JA01#	12pF	±5%
		15000pF		±5%	GRM2161X1H153JA01#			15pF			±5%	GRM21A5C2E150JW01#	
		18000pF		±5%	GRM2161X1H183JA01#			18pF			±5%	GRM21A5C2E180JW01#	
		U2J	12000pF	±5%	GRM2167U1H123JA01#			22pF			±5%	GRM21A5C2E220JW01#	
			15000pF	±5%	GRM2167U1H153JA01#			27pF			±5%	GRM21A5C2E270JW01#	
			18000pF	±5%	GRM2167U1H183JA01#			33pF			±5%	GRM21A5C2E330JW01#	
		UJ	10000pF	±5%	GRM2163U1H103JA01#			39pF			±5%	GRM21A5C2E390JW01#	
			12000pF	±5%	GRM2163U1H123JA01#			47pF	±5%	GRM21A5C2E470JW01#			
			15000pF	±5%	GRM2163U1H153JA01#			56pF	±5%	GRM21A5C2E560JW01#			
			18000pF	±5%	GRM2163U1H183JA01#			68pF	±5%	GRM21A5C2E680JW01#			
		0.95mm	50Vdc	COG	5600pF			±5%	GRM2195C1H562JA01#	82pF	±5%	GRM21A5C2E820JW01#	
					6800pF			±5%	GRM2195C1H682JA01#	100pF	±5%	GRM21A5C2E101JW01#	
					8200pF			±5%	GRM2195C1H822JA01#	120pF	±5%	GRM21A5C2E121JW01#	
					10000pF			±5%	GRM2195C1H103JA01#	150pF	±5%	GRM21A5C2E151JW01#	
12000pF	±5%				GRM2195C1H123JA01#	180pF	±5%	GRM21A5C2E181JW01#					
15000pF	±5%				GRM2195C1H153JA01#	220pF	±5%	GRM21A5C2E221JW01#					
CH	5600pF			±5%	GRM2192C1H562JA01#	270pF	±5%	GRM21A5C2E271JW01#					
	6800pF			±5%	GRM2192C1H682JA01#	330pF	±5%	GRM21A5C2E331JW01#					
	8200pF			±5%	GRM2192C1H822JA01#	390pF	±5%	GRM21A5C2E391JWA1#					
	10000pF			±5%	GRM2192C1H103JA01#	470pF	±5%	GRM21A5C2E471JWA1#					
	12000pF			±5%	GRM2192C1H123JA01#	560pF	±5%	GRM21A5C2E561JWA1#					
	15000pF			±5%	GRM2192C1H153JA01#	680pF	±5%	GRM21A5C2E681JWA1#					
	SL			22000pF	±5%	GRM2191X1H223JA01#	820pF	±5%	GRM21A5C2E821JWA1#				
				27000pF	±5%	GRM2191X1H273JA01#	1000pF	±5%	GRM21A5C2E102JWA1#				
	U2J			22000pF	±5%	GRM2197U1H223JA01#	1200pF	±5%	GRM21A5C2E122JWA1#				
27000pF				±5%	GRM2197U1H273JA01#	1500pF	±5%	GRM21A5C2E152JWA1#					
UJ	22000pF			±5%	GRM2193U1H223JA01#	1800pF	±5%	GRM21A5C2E182JWA1#					
	27000pF			±5%	GRM2193U1H273JA01#	2200pF	±5%	GRM21A5C2E222JWA1#					
10Vdc	SL			56000pF	±5%	GRM2191X1A563JA01#	2700pF	±5%	GRM21A5C2E272JWA1#				
				U2J	56000pF	±5%	GRM2197U1A563JA01#	U2J	100pF	±5%	GRM21A7U2E101JW31#		
				UJ	56000pF	±5%	GRM2193U1A563JA01#		120pF	±5%	GRM21A7U2E121JW31#		
1.0mm	630Vdc	COG	10pF	±5%	GRM21A5C2J100JWA1#	150pF	±5%		GRM21A7U2E151JW31#				
			12pF	±5%	GRM21A5C2J120JWA1#	180pF	±5%	GRM21A7U2E181JW31#					
			15pF	±5%	GRM21A5C2J150JWA1#	220pF	±5%	GRM21A7U2E221JW31#					
			18pF	±5%	GRM21A5C2J180JWA1#	270pF	±5%	GRM21A7U2E271JW31#					
			22pF	±5%	GRM21A5C2J220JWA1#	330pF	±5%	GRM21A7U2E331JW31#					
			27pF	±5%	GRM21A5C2J270JWA1#	390pF	±5%	GRM21A7U2E391JW31#					
			33pF	±5%	GRM21A5C2J330JWA1#	470pF	±5%	GRM21A7U2E471JW31#					
			39pF	±5%	GRM21A5C2J390JWA1#	560pF	±5%	GRM21A7U2E561JW31#					
			47pF	±5%	GRM21A5C2J470JWA1#	680pF	±5%	GRM21A7U2E681JW31#					
			56pF	±5%	GRM21A5C2J560JWA1#	820pF	±5%	GRM21A7U2E821JW31#					
			68pF	±5%	GRM21A5C2J680JWA1#	1000pF	±5%	GRM21A7U2E102JW31#					
			82pF	±5%	GRM21A5C2J820JWA1#	1200pF	±5%	GRM21A7U2E122JW31#					
			100pF	±5%	GRM21A5C2J101JWA1#	1500pF	±5%	GRM21A7U2E152JW31#					
			120pF	±5%	GRM21A5C2J121JWA1#	1800pF	±5%	GRM21A7U2E182JW31#					
			150pF	±5%	GRM21A5C2J151JWA1#	2200pF	±5%	GRM21A7U2E222JW31#					
			180pF	±5%	GRM21A5C2J181JWA1#	200Vdc	COG	10pF	±5%	GRM21A5C2D100JW01#			

Part number # indicates the package specification code.

⚠Caution / Notice

GRM
 GR3
 GRJ
 GR4
 GR7
 GJM
 GQM
 GA2
 GA3 GB
 GA3 GD
 GA3 GF
 LLL
 LLA
 LLM
 LLR
 NFM
 KRM
 KR3
 GMA
 GMD

GRM Series Temperature Compensating Type Part Number List

(→ 2.0×1.25mm)

T max.	Rated Voltage	TC Code	Cap.	Tol.	Part Number			
1.0mm	200Vdc	COG	12pF	±5%	GRM21A5C2D120JW01#			
			15pF	±5%	GRM21A5C2D150JW01#			
			18pF	±5%	GRM21A5C2D180JW01#			
			22pF	±5%	GRM21A5C2D220JW01#			
			27pF	±5%	GRM21A5C2D270JW01#			
			33pF	±5%	GRM21A5C2D330JW01#			
			39pF	±5%	GRM21A5C2D390JW01#			
			47pF	±5%	GRM21A5C2D470JW01#			
			56pF	±5%	GRM21A5C2D560JW01#			
			68pF	±5%	GRM21A5C2D680JW01#			
			82pF	±5%	GRM21A5C2D820JW01#			
			100pF	±5%	GRM21A5C2D101JW01#			
			120pF	±5%	GRM21A5C2D121JW01#			
			150pF	±5%	GRM21A5C2D151JW01#			
			180pF	±5%	GRM21A5C2D181JW01#			
			220pF	±5%	GRM21A5C2D221JW01#			
			270pF	±5%	GRM21A5C2D271JW01#			
			330pF	±5%	GRM21A5C2D331JW01#			
			U2J	100pF	±5%	GRM21A7U2D101JW31#		
				120pF	±5%	GRM21A7U2D121JW31#		
				150pF	±5%	GRM21A7U2D151JW31#		
				180pF	±5%	GRM21A7U2D181JW31#		
				220pF	±5%	GRM21A7U2D221JW31#		
				270pF	±5%	GRM21A7U2D271JW31#		
				330pF	±5%	GRM21A7U2D331JW31#		
				390pF	±5%	GRM21A7U2D391JW31#		
				470pF	±5%	GRM21A7U2D471JW31#		
				560pF	±5%	GRM21A7U2D561JW31#		
				680pF	±5%	GRM21A7U2D681JW31#		
				820pF	±5%	GRM21A7U2D821JW31#		
			50Vdc	SL	33000pF	±5%	GRM21A1X1H333JA39#	
					U2J	33000pF	±5%	GRM21A7U1H333JA39#
					UJ	33000pF	±5%	GRM21A3U1H333JA39#
	COG	18000pF		±5%	GRM21B5C1H183JA01#			
		22000pF		±5%	GRM21B5C1H223JA01#			
		CH		18000pF	±5%	GRM21B2C1H183JA01#		
	22000pF	±5%	GRM21B2C1H223JA01#					
	SL	39000pF	±5%	GRM21B1X1H393JA01#				
		47000pF	±5%	GRM21B1X1H473JA01#				
	U2J	39000pF	±5%	GRM21B7U1H393JA01#				
		47000pF	±5%	GRM21B7U1H473JA01#				
	UJ	39000pF	±5%	GRM21B3U1H393JA01#				
		47000pF	±5%	GRM21B3U1H473JA01#				
	10Vdc	SL	6800pF	±5%	GRM21B1X1A683JA01#			
			8200pF	±5%	GRM21B1X1A823JA01#			
0.10μF			±5%	GRM21B1X1A104JA01#				
U2J		6800pF	±5%	GRM21B7U1A683JA01#				
		8200pF	±5%	GRM21B7U1A823JA01#				
		0.10μF	±5%	GRM21B7U1A104JA01#				

T max.	Rated Voltage	TC Code	Cap.	Tol.	Part Number		
1.35mm	10Vdc	UJ	6800pF	±5%	GRM21B3U1A683JA01#		
			8200pF	±5%	GRM21B3U1A823JA01#		
			0.10μF	±5%	GRM21B3U1A104JA01#		
1.45mm	630Vdc	COG	680pF	±5%	GRM21B5C2J681JWA3#		
			820pF	±5%	GRM21B5C2J821JWA3#		
			1000pF	±5%	GRM21B5C2J102JWA3#		
			1200pF	±5%	GRM21B5C2J122JWA3#		
			250Vdc	COG	3300pF	±5%	GRM21B5C2E332JWA1#
					3900pF	±5%	GRM21B5C2E392JWA1#
	4700pF	±5%			GRM21B5C2E472JWA1#		
	U2J	2700pF		±5%	GRM21B7U2E272JW32#		
		3300pF		±5%	GRM21B7U2E332JW32#		
		3900pF		±5%	GRM21B7U2E392JW32#		
	200Vdc	U2J	4700pF	±5%	GRM21B7U2E472JW32#		
			5600pF	±5%	GRM21B7U2E562JW32#		
2700pF			±5%	GRM21B7U2D272JW32#			
3300pF			±5%	GRM21B7U2D332JW32#			
3900pF			±5%	GRM21B7U2D392JW32#			
4700pF			±5%	GRM21B7U2D472JW32#			
5600pF	±5%	GRM21B7U2D562JW32#					

3.2×1.6mm

T max.	Rated Voltage	TC Code	Cap.	Tol.	Part Number	
0.95mm	100Vdc	COG	1800pF	±5%	GRM3195C2A182JA01#	
			2200pF	±5%	GRM3195C2A222JA01#	
			2700pF	±5%	GRM3195C2A272JA01#	
			3300pF	±5%	GRM3195C2A332JA01#	
			3900pF	±5%	GRM3195C2A392JA01#	
			4700pF	±5%	GRM3195C2A472JA01#	
			5600pF	±5%	GRM3195C2A562JA01#	
			6800pF	±5%	GRM3195C2A682JA01#	
			8200pF	±5%	GRM3195C2A822JA01#	
			10000pF	±5%	GRM3195C2A103JA01#	
			12000pF	±5%	GRM3195C2A123JA01#	
			15000pF	±5%	GRM3195C2A153JA01#	
			18000pF	±5%	GRM3195C2A183JA01#	
			22000pF	±5%	GRM3195C2A223JA01#	
			27000pF	±5%	GRM3195C2A273JA01#	
			33000pF	±5%	GRM3195C2A333JA01#	
			39000pF	±5%	GRM3195C2A393JA01#	
			CH	1800pF	±5%	GRM3192C2A182JA01#
				2200pF	±5%	GRM3192C2A222JA01#
				2700pF	±5%	GRM3192C2A272JA01#
				3300pF	±5%	GRM3192C2A332JA01#
				3900pF	±5%	GRM3192C2A392JA01#
				4700pF	±5%	GRM3192C2A472JA01#
				5600pF	±5%	GRM3192C2A562JA01#
				6800pF	±5%	GRM3192C2A682JA01#
				8200pF	±5%	GRM3192C2A822JA01#
			10000pF	±5%	GRM3192C2A103JA01#	
12000pF	±5%	GRM3192C2A123JA01#				
15000pF	±5%	GRM3192C2A153JA01#				

Part number # indicates the package specification code.

GRM Series Temperature Compensating Type Part Number List

(→ 3.2×1.6mm)

T max.	Rated Voltage	TC Code	Cap.	Tol.	Part Number	T max.	Rated Voltage	TC Code	Cap.	Tol.	Part Number					
0.95mm	100Vdc	CH	1800pF	±5%	GRM3192C2A183JA01#	1.0mm	1000Vdc	U2J	10pF	±5%	GRM31A7U3A100JW31#					
			2200pF	±5%	GRM3192C2A223JA01#				12pF	±5%	GRM31A7U3A120JW31#					
			2700pF	±5%	GRM3192C2A273JA01# D1				15pF	±5%	GRM31A7U3A150JW31#					
			3300pF	±5%	GRM3192C2A333JA01# D1				18pF	±5%	GRM31A7U3A180JW31#					
			3900pF	±5%	GRM3192C2A393JA01# D1				22pF	±5%	GRM31A7U3A220JW31#					
	50Vdc	COG	1200pF	±5%	GRM3195C1H123JA01#				27pF	±5%	GRM31A7U3A270JW31#					
			1500pF	±5%	GRM3195C1H153JA01#				33pF	±5%	GRM31A7U3A330JW31#					
			1800pF	±5%	GRM3195C1H183JA01#				39pF	±5%	GRM31A7U3A390JW31#					
			2200pF	±5%	GRM3195C1H223JA01#				47pF	±5%	GRM31A7U3A470JW31#					
			2700pF	±5%	GRM3195C1H273JA01#				56pF	±5%	GRM31A7U3A560JW31#					
			3300pF	±5%	GRM3195C1H333JA01#				68pF	±5%	GRM31A7U3A680JW31#					
			3900pF	±5%	GRM3195C1H393JA01#				82pF	±5%	GRM31A7U3A820JW31#					
			CH	1200pF	±5%				GRM3192C1H123JA01#	100pF	±5%	GRM31A7U3A101JW31#				
				1500pF	±5%				GRM3192C1H153JA01#	120pF	±5%	GRM31A7U3A121JW31#				
				1800pF	±5%				GRM3192C1H183JA01#	150pF	±5%	GRM31A7U3A151JW31#				
		2200pF		±5%	GRM3192C1H223JA01#				180pF	±5%	GRM31A7U3A181JW31#					
		2700pF		±5%	GRM3192C1H273JA01#				220pF	±5%	GRM31A7U3A221JW31#					
		3300pF		±5%	GRM3192C1H333JA01#				270pF	±5%	GRM31A7U3A271JW31#					
		3900pF		±5%	GRM3192C1H393JA01#				330pF	±5%	GRM31A7U3A331JW31#					
		SL		5600pF	±5%				GRM3191X1H563JA01#	630Vdc	COG	10pF	±5%	GRM31A5C2J100JW01#		
				U2J	5600pF				±5%			GRM3197U1H563JA01#	12pF	±5%	GRM31A5C2J120JW01#	
		UJ		5600pF	±5%				GRM3193U1H563JA01#			15pF	±5%	GRM31A5C2J150JW01#		
		1.0mm	2000Vdc	U2J	10pF				±5%			GRM31A7U3D100JW31#	18pF	±5%	GRM31A5C2J180JW01#	
					12pF				±5%			GRM31A7U3D120JW31#	22pF	±5%	GRM31A5C2J220JW01#	
					15pF				±5%			GRM31A7U3D150JW31#	27pF	±5%	GRM31A5C2J270JW01#	
	18pF				±5%				GRM31A7U3D180JW31#			33pF	±5%	GRM31A5C2J330JW01#		
	22pF				±5%				GRM31A7U3D220JW31#			39pF	±5%	GRM31A5C2J390JW01#		
	27pF				±5%				GRM31A7U3D270JW31#			47pF	±5%	GRM31A5C2J470JW01#		
	33pF				±5%				GRM31A7U3D330JW31#			56pF	±5%	GRM31A5C2J560JW01#		
	39pF				±5%				GRM31A7U3D390JW31#			68pF	±5%	GRM31A5C2J680JW01#		
	47pF				±5%				GRM31A7U3D470JW31#			82pF	±5%	GRM31A5C2J820JW01#		
	56pF				±5%				GRM31A7U3D560JW31#			100pF	±5%	GRM31A5C2J101JW01#		
	68pF				±5%				GRM31A7U3D680JW31#			120pF	±5%	GRM31A5C2J121JW01#		
	1000Vdc				COG				10pF			±5%	GRM31A5C3A100JW01#	150pF	±5%	GRM31A5C2J151JW01#
									12pF			±5%	GRM31A5C3A120JW01#	180pF	±5%	GRM31A5C2J181JW01#
									15pF			±5%	GRM31A5C3A150JW01#	220pF	±5%	GRM31A5C2J221JW01#
18pF			±5%	GRM31A5C3A180JW01#		270pF	±5%	GRM31A5C2J271JW01#								
22pF			±5%	GRM31A5C3A220JW01#		330pF	±5%	GRM31A5C2J331JW01#								
27pF			±5%	GRM31A5C3A270JW01#		390pF	±5%	GRM31A5C2J391JW01#								
33pF			±5%	GRM31A5C3A330JW01#		470pF	±5%	GRM31A5C2J471JW01#								
39pF			±5%	GRM31A5C3A390JW01#		560pF	±5%	GRM31A5C2J561JW01#								
47pF			±5%	GRM31A5C3A470JW01#		1200pF	±5%	GRM31A5C2J122JWA1#								
56pF			±5%	GRM31A5C3A560JW01#		1500pF	±5%	GRM31A5C2J152JWA1#								
U2J	68pF		±5%	GRM31A5C3A680JW01#	1800pF	±5%	GRM31A5C2J182JWA1#									
	82pF		±5%	GRM31A5C3A820JW01#	10pF	±5%	GRM31A7U2J100JW31#									
	100pF		±5%	GRM31A5C3A101JW01#	12pF	±5%	GRM31A7U2J120JW31#									
	120pF	±5%	GRM31A5C3A121JW01#	15pF	±5%	GRM31A7U2J150JW31#										
	150pF	±5%	GRM31A5C3A151JW01#	18pF	±5%	GRM31A7U2J180JW31#										
	180pF	±5%	GRM31A5C3A181JW01#	22pF	±5%	GRM31A7U2J220JW31#										
	220pF	±5%	GRM31A5C3A221JW01#	27pF	±5%	GRM31A7U2J270JW31#										
	270pF	±5%	GRM31A5C3A271JWA1#	33pF	±5%	GRM31A7U2J330JW31#										
	330pF	±5%	GRM31A5C3A331JWA1#	39pF	±5%	GRM31A7U2J390JW31#										
	390pF	±5%	GRM31A5C3A391JWA1#	47pF	±5%	GRM31A7U2J470JW31#										
470pF	±5%	GRM31A5C3A471JWA1#	56pF	±5%	GRM31A7U2J560JW31#											

- GRM
- GR3
- GRJ
- GR4
- GR7
- GJM
- GQM
- GA2
- GA3 GB
- GA3 GD
- GA3 GF
- LLL
- LLA
- LLM
- LLR
- NFM
- KRM
- KR3
- GMA
- GMD
- ⚠Caution /Notice

Part number # indicates the package specification code.

GRM Series Temperature Compensating Type Part Number List

(→ 3.2×1.6mm)

T max.	Rated Voltage	TC Code	Cap.	Tol.	Part Number	T max.	Rated Voltage	TC Code	Cap.	Tol.	Part Number		
1.0mm	630Vdc	U2J	68pF	±5%	GRM31A7U2J680JW31#	1.0mm	500Vdc	U2J	120pF	±5%	GRM31A7U2H121JW31#		
			82pF	±5%	GRM31A7U2J820JW31#				150pF	±5%	GRM31A7U2H151JW31#		
			100pF	±5%	GRM31A7U2J101JW31#				180pF	±5%	GRM31A7U2H181JW31#		
			120pF	±5%	GRM31A7U2J121JW31#				220pF	±5%	GRM31A7U2H221JW31#		
			150pF	±5%	GRM31A7U2J151JW31#				270pF	±5%	GRM31A7U2H271JW31#		
			180pF	±5%	GRM31A7U2J181JW31#				330pF	±5%	GRM31A7U2H331JW31#		
			220pF	±5%	GRM31A7U2J221JW31#				390pF	±5%	GRM31A7U2H391JW31#		
			270pF	±5%	GRM31A7U2J271JW31#				470pF	±5%	GRM31A7U2H471JW31#		
			330pF	±5%	GRM31A7U2J331JW31#				560pF	±5%	GRM31A7U2H561JW31#		
			390pF	±5%	GRM31A7U2J391JW31#				680pF	±5%	GRM31A7U2H681JW31#		
			470pF	±5%	GRM31A7U2J471JW31#				820pF	±5%	GRM31A7U2H821JW31#		
			560pF	±5%	GRM31A7U2J561JW31#				1000pF	±5%	GRM31A7U2H102JW31#		
			680pF	±5%	GRM31A7U2J681JW31#				1200pF	±5%	GRM31A7U2H122JW31#		
			820pF	±5%	GRM31A7U2J821JW31#				1500pF	±5%	GRM31A7U2H152JW31#		
			1000pF	±5%	GRM31A7U2J102JW31#				1800pF	±5%	GRM31A7U2H182JW31#		
			1200pF	±5%	GRM31A7U2J122JW31#				2200pF	±5%	GRM31A7U2H222JW31#		
			1500pF	±5%	GRM31A7U2J152JW31#				250Vdc	COG	390pF	±5%	GRM31A5C2E391JWA1#
			1800pF	±5%	GRM31A7U2J182JW31#						470pF	±5%	GRM31A5C2E471JWA1#
			2200pF	±5%	GRM31A7U2J222JW31#						560pF	±5%	GRM31A5C2E561JWA1#
			10pF	±5%	GRM31A5C2H100JW01#						680pF	±5%	GRM31A5C2E681JWA1#
			12pF	±5%	GRM31A5C2H120JW01#						820pF	±5%	GRM31A5C2E821JWA1#
			15pF	±5%	GRM31A5C2H150JW01#						1000pF	±5%	GRM31A5C2E102JWA1#
			18pF	±5%	GRM31A5C2H180JW01#						1200pF	±5%	GRM31A5C2E122JWA1#
			22pF	±5%	GRM31A5C2H220JW01#						1500pF	±5%	GRM31A5C2E152JWA1#
	27pF	±5%	GRM31A5C2H270JW01#	1800pF	±5%		GRM31A5C2E182JWA1#						
	33pF	±5%	GRM31A5C2H330JW01#	2200pF	±5%		GRM31A5C2E222JWA1#						
	39pF	±5%	GRM31A5C2H390JW01#	2700pF	±5%		GRM31A5C2E272JWA1#						
	47pF	±5%	GRM31A5C2H470JW01#	3300pF	±5%		GRM31A5C2E332JWA1#						
	56pF	±5%	GRM31A5C2H560JW01#	3900pF	±5%		GRM31A5C2E392JWA1#						
	68pF	±5%	GRM31A5C2H680JW01#	4700pF	±5%		GRM31A5C2E472JWA1#						
	82pF	±5%	GRM31A5C2H820JW01#	5600pF	±5%		GRM31A5C2E562JWA1#						
	100pF	±5%	GRM31A5C2H101JW01#	6800pF	±5%		GRM31A5C2E682JWA1#						
	120pF	±5%	GRM31A5C2H121JW01#	U2J	2700pF		±5%	GRM31A7U2E272JW31#					
	150pF	±5%	GRM31A5C2H151JW01#		3300pF		±5%	GRM31A7U2E332JW31#					
	180pF	±5%	GRM31A5C2H181JW01#		3900pF		±5%	GRM31A7U2E392JW31#					
	220pF	±5%	GRM31A5C2H221JW01#		4700pF		±5%	GRM31A7U2E472JW31#					
	270pF	±5%	GRM31A5C2H271JW01#		5600pF		±5%	GRM31A7U2E562JW31#					
	330pF	±5%	GRM31A5C2H331JW01#		200Vdc		U2J	2700pF	±5%	GRM31A7U2D272JW31#			
	390pF	±5%	GRM31A5C2H391JW01#	3300pF				±5%	GRM31A7U2D332JW31#				
	470pF	±5%	GRM31A5C2H471JW01#	3900pF				±5%	GRM31A7U2D392JW31#				
	560pF	±5%	GRM31A5C2H561JW01#	4700pF				±5%	GRM31A7U2D472JW31#				
	10pF	±5%	GRM31A7U2H100JW31#	5600pF				±5%	GRM31A7U2D562JW31#				
	12pF	±5%	GRM31A7U2H120JW31#	1.25mm				1000Vdc	COG	560pF	±5%	GRM31B5C3A561JWA1#	
	15pF	±5%	GRM31A7U2H150JW31#		680pF		±5%			GRM31B5C3A681JWA1#			
	18pF	±5%	GRM31A7U2H180JW31#		U2J		390pF			±5%	GRM31B7U3A391JW31#		
	22pF	±5%	GRM31A7U2H220JW31#				470pF			±5%	GRM31B7U3A471JW31#		
	27pF	±5%	GRM31A7U2H270JW31#				560pF			±5%	GRM31B7U3A561JW31#		
	33pF	±5%	GRM31A7U2H330JW31#				680pF			±5%	GRM31B7U3A681JW31#		
39pF	±5%	GRM31A7U2H390JW31#	630Vdc	COG		680pF	±5%	GRM31B5C2J681JW01#					
47pF	±5%	GRM31A7U2H470JW31#				820pF	±5%	GRM31B5C2J821JW01#					
56pF	±5%	GRM31A7U2H560JW31#			1000pF	±5%	GRM31B5C2J102JW01#						
68pF	±5%	GRM31A7U2H680JW31#			2200pF	±5%	GRM31B5C2J222JWA1#						
82pF	±5%	GRM31A7U2H820JW31#			2700pF	±5%	GRM31B5C2J272JWA1#						
100pF	±5%	GRM31A7U2H101JW31#			U2J	2700pF	±5%	GRM31B7U2J272JW31#					

Part number # indicates the package specification code.



GRM Series Temperature Compensating Type Part Number List

(→ 3.2×1.6mm)

T max.	Rated Voltage	TC Code	Cap.	Tol.	Part Number	
1.25mm	630Vdc	U2J	3300pF	±5%	GRM31B7U2J332JW31#	
		COG	680pF	±5%	GRM31B5C2H681JW01#	
			820pF	±5%	GRM31B5C2H821JW01#	
			1000pF	±5%	GRM31B5C2H102JW01#	
		U2J	2700pF	±5%	GRM31B7U2H272JW31#	
			3300pF	±5%	GRM31B7U2H332JW31#	
	250Vdc		COG	8200pF	±5%	GRM31B5C2E822JWA1#
		10000pF		±5%	GRM31B5C2E103JWA1#	
		12000pF		±5%	GRM31B5C2E123JWA1#	
		U2J	6800pF	±5%	GRM31B7U2E682JW31#	
			8200pF	±5%	GRM31B7U2E822JW31#	
			10000pF	±5%	GRM31B7U2E103JW31#	
	12000pF	±5%	GRM31B7U2E123JW31#			
		200Vdc	U2J	6800pF	±5%	GRM31B7U2D682JW31#
				8200pF	±5%	GRM31B7U2D822JW31#
	10000pF			±5%	GRM31B7U2D103JW31#	
	100Vdc	COG	47000pF	±5%	GRM31M5C2A473JA01# D1	
			56000pF	±5%	GRM31M5C2A563JA01# D1	
		CH	47000pF	±5%	GRM31M2C2A473JA01# D1	
			56000pF	±5%	GRM31M2C2A563JA01# D1	
	50Vdc	COG	47000pF	±5%	GRM31M5C1H473JA01#	
			56000pF	±5%	GRM31M5C1H563JA01#	
		CH	47000pF	±5%	GRM31M2C1H473JA01#	
			56000pF	±5%	GRM31M2C1H563JA01#	
SL		68000pF	±5%	GRM31M1X1H683JA01#		
		82000pF	±5%	GRM31M1X1H823JA01#		
0.10µF		±5%	GRM31M1X1H104JA01#			
		U2J	68000pF	±5%	GRM31M7U1H683JA01#	
82000pF			±5%	GRM31M7U1H823JA01#		
0.10µF			±5%	GRM31M7U1H104JA01#		
UJ		68000pF	±5%	GRM31M3U1H683JA01#		
		82000pF	±5%	GRM31M3U1H823JA01#		
	0.10µF	±5%	GRM31M3U1H104JA01#			
1.8mm	1000Vdc	COG	820pF	±5%	GRM31C5C3A821JWA3#	
			1000pF	±5%	GRM31C5C3A102JWA3#	
		U2J	820pF	±5%	GRM31C7U3A821JW32#	
			1000pF	±5%	GRM31C7U3A102JW32#	
	630Vdc	COG	3300pF	±5%	GRM31C5C2J332JWA3#	
			U2J	3900pF	±5%	GRM31C7U2J392JW32#
	4700pF	±5%	GRM31C7U2J472JW32#			
		500Vdc	U2J	3900pF	±5%	GRM31C7U2H392JW32#
	4700pF			±5%	GRM31C7U2H472JW32#	
	250Vdc	COG	15000pF	±5%	GRM31C5C2E153JWA3#	
			U2J	15000pF	±5%	GRM31C7U2E153JW32#
			18000pF	±5%	GRM31C7U2E183JW32#	
	22000pF	±5%	GRM31C7U2E223JW32#			
		100Vdc	COG	68000pF	±5%	GRM31C5C2A683JA01# D1
				82000pF	±5%	GRM31C5C2A823JA01# D1
	0.10µF			±5%	GRM31C5C2A104JA01# D1	
	CH	68000pF	±5%	GRM31C2C2A683JA01# D1		
		82000pF	±5%	GRM31C2C2A823JA01# D1		
		0.10µF	±5%	GRM31C2C2A104JA01# D1		
	50Vdc	COG	68000pF	±5%	GRM31C5C1H683JA01#	
			82000pF	±5%	GRM31C5C1H823JA01#	

T max.	Rated Voltage	TC Code	Cap.	Tol.	Part Number		
1.8mm	50Vdc	COG	0.10µF	±5%	GRM31C5C1H104JA01#		
			CH	68000pF	±5%	GRM31C2C1H683JA01#	
				82000pF	±5%	GRM31C2C1H823JA01#	
		0.10µF	±5%	GRM31C2C1H104JA01#			
			25Vdc	COG	0.12µF	±5%	GRM31C5C1E124JA01#
					CH	0.12µF	±5%
	16Vdc	COG	0.12µF	±5%	GRM31C5C1C124JA01#		
			CH	0.12µF	±5%	GRM31C2C1C124JA01#	

3.2×2.5mm

T max.	Rated Voltage	TC Code	Cap.	Tol.	Part Number			
1.0mm	2000Vdc	U2J	82pF	±5%	GRM32A7U3D820JW31#			
			100pF	±5%	GRM32A7U3D101JW31#			
			120pF	±5%	GRM32A7U3D121JW31#			
			150pF	±5%	GRM32A7U3D151JW31#			
			630Vdc	U2J	1200pF	±5%	GRM32A7U2J122JW31#	
					1500pF	±5%	GRM32A7U2J152JW31#	
	1800pF	±5%			GRM32A7U2J182JW31#			
	2200pF	±5%			GRM32A7U2J222JW31#			
	500Vdc	U2J	1200pF	±5%	GRM32A7U2H122JW31#			
			1500pF	±5%	GRM32A7U2H152JW31#			
			1800pF	±5%	GRM32A7U2H182JW31#			
			2200pF	±5%	GRM32A7U2H222JW31#			
			1.25mm	2000Vdc	U2J	180pF	±5%	GRM32B7U3D181JW31#
						220pF	±5%	GRM32B7U3D221JW31#
	1000Vdc	U2J		1200pF	±5%	GRM32B7U3A122JW31#		
				630Vdc	U2J	5600pF	±5%	GRM32B7U2J562JW31#
	500Vdc	U2J		5600pF	±5%	GRM32B7U2H562JW31#		
				1.5mm	1000Vdc	U2J	1500pF	±5%
630Vdc	U2J	6800pF	±5%				GRM32Q7U2J682JW31#	
500Vdc	U2J	6800pF	±5%		GRM32Q7U2H682JW31#			
		250Vdc	U2J		27000pF	±5%	GRM32Q7U2E273JW31#	
2.0mm	1000Vdc	U2J	1800pF		±5%	GRM32D7U3A182JW31#		
			2200pF		±5%	GRM32D7U3A222JW31#		
	630Vdc	U2J	8200pF	±5%	GRM32D7U2J822JW31#			
			10000pF	±5%	GRM32D7U2J103JW31#			
	500Vdc	U2J	8200pF	±5%	GRM32D7U2H822JW31#			
			10000pF	±5%	GRM32D7U2H103JW31#			
250Vdc	U2J	33000pF	±5%	GRM32D7U2E333JW31#				
		39000pF	±5%	GRM32D7U2E393JW31#				
47000pF	±5%	GRM32D7U2E473JW31#						

4.5×2.0mm

T max.	Rated Voltage	TC Code	Cap.	Tol.	Part Number
1.0mm	3150Vdc	U2J	10pF	±5%	GRM42A7U3F100JW31#
			12pF	±5%	GRM42A7U3F120JW31#
			15pF	±5%	GRM42A7U3F150JW31#
			18pF	±5%	GRM42A7U3F180JW31#
			22pF	±5%	GRM42A7U3F220JW31#
			27pF	±5%	GRM42A7U3F270JW31#

Part number # indicates the package specification code.

⚠Caution / Notice

GRM
 GR3
 GRJ
 GR4
 GR7
 GJM
 GQM
 GA2
 GA3 GB
 GA3 GD
 GA3 GF
 LLL
 LLA
 LLM
 LLR
 NFM
 KRM
 KR3
 GMA
 GMD

GRM Series Temperature Compensating Type Part Number List

(→ 4.5×2.0mm)

T max.	Rated Voltage	TC Code	Cap.	Tol.	Part Number
1.0mm	3150Vdc	U2J	33pF	±5%	GRM42A7U3F330JW31#
			39pF	±5%	GRM42A7U3F390JW31#
			47pF	±5%	GRM42A7U3F470JW31#
			56pF	±5%	GRM42A7U3F560JW31#
			68pF	±5%	GRM42A7U3F680JW31#
			82pF	±5%	GRM42A7U3F820JW31#
			100pF	±5%	GRM42A7U3F101JW31#

4.5×3.2mm

T max.	Rated Voltage	TC Code	Cap.	Tol.	Part Number
1.5mm	1000Vdc	U2J	2700pF	±5%	GRM43Q7U3A272JW31#
			3300pF	±5%	GRM43Q7U3A332JW31#
	630Vdc	U2J	12000pF	±5%	GRM43Q7U2J123JW31#
			500Vdc	U2J	12000pF
2.0mm	1000Vdc	U2J	3900pF	±5%	GRM43D7U3A392JW31#
			4700pF	±5%	GRM43D7U3A472JW31#
	630Vdc	U2J	15000pF	±5%	GRM43D7U2J153JW31#
			18000pF	±5%	GRM43D7U2J183JW31#
			22000pF	±5%	GRM43D7U2J223JW31#
	500Vdc	U2J	15000pF	±5%	GRM43D7U2H153JW31#
			18000pF	±5%	GRM43D7U2H183JW31#
			22000pF	±5%	GRM43D7U2H223JW31#

5.7×5.0mm

T max.	Rated Voltage	TC Code	Cap.	Tol.	Part Number
1.5mm	1000Vdc	U2J	5600pF	±5%	GRM55Q7U3A562JW31#
			6800pF	±5%	GRM55Q7U3A682JW31#
	630Vdc	U2J	27000pF	±5%	GRM55Q7U2J273JW31#
			500Vdc	U2J	27000pF
2.0mm	1000Vdc	U2J	8200pF	±5%	GRM55D7U3A822JW31#
			10000pF	±5%	GRM55D7U3A103JW31#
	630Vdc	U2J	33000pF	±5%	GRM55D7U2J333JW31#
			39000pF	±5%	GRM55D7U2J393JW31#
			47000pF	±5%	GRM55D7U2J473JW31#
	500Vdc	U2J	33000pF	±5%	GRM55D7U2H333JW31#
			39000pF	±5%	GRM55D7U2H393JW31#
			47000pF	±5%	GRM55D7U2H473JW31#

GRM
 GR3
 GRJ
 GR4
 GR7
 GJM
 GQM
 GA2
 GA3 GB
 GA3 GD
 GA3 GF
 LLL
 LLA
 LLM
 LLR
 NFM
 KRM
 KR3
 GMA
 GMD
 ⚠Caution /Notice

**GRM, GR3, GRJ, GR4, GR7, GJM,
 GQM, GA2, GA3, LLL, LLA, LLM,
 LLR, NFM, KRM, KR3, GMA, GMD**

⚠️ Caution/Notice

WEB 

⚠️ Caution

Notice

Storage and Operation Conditions 266

Rating 266

 1. Temperature Dependent Characteristics 266

 2. Measurement of Capacitance 266

 3. Applied Voltage and Applied Current 267

 4. Type of Applied Voltage and Self-heating Temperature 267

 5. DC Voltage and AC Voltage Characteristics 270

 6. Capacitance Aging 270

 7. Vibration and Shock 271

Soldering and Mounting 271

 1. Mounting Position 271

 2. Information before Mounting 272

 3. Maintenance of the Mounting (pick and place) Machine 272

 4-1. Reflow Soldering 273

 4-2. Flow Soldering 275

 4-3. Correction of Soldered Portion 276

 5. Washing 277

 6. Electrical Test on Printed Circuit Board 277

 7. Printed Circuit Board Cropping 277

 8. Assembly 280

 9. Die Bonding/Wire Bonding 281

Other 281

 1. Under Operation of Equipment 281

 2. Other 282

Rating 283

 1. Operating Temperature 283

 2. Atmosphere Surroundings (gaseous and liquid) 283

 3. Piezo-electric Phenomenon 283

Soldering and Mounting 283

 1. PCB Design 283

 1. Notice for Pattern Forms 283

 2. Land Dimensions 284

 3. Board Design 288

 2. Adhesive Application 288

 3. Adhesive Curing 289

 4. Flux for Flow Soldering 289

 5. Flow Soldering 289

 6. Reflow Soldering 289

 7. Washing 290

 8. Coating 290

Other 290

 1. Transportation 290

 2. Characteristics Evaluation in the Actual System 290

GRM
 GR3
 GRJ
 GR4
 GR7
 GJM
 GQM
 GA2
 GA3
 GA3
 GA3
 GA3
 LLL
 LLA
 LLM
 LLR
 NFM
 KRM
 KR3
 GMA
 GMD

⚠️ Caution / Notice

⚠Caution

Storage and Operation Conditions

1. The performance of chip multilayer ceramic capacitors and chip EMIFIL NFM series (henceforth just “capacitors”) may be affected by the storage conditions.

Please use them promptly after delivery.

1-1. Maintain appropriate storage for the capacitors using the following conditions: Room Temperature of +5 to +40°C and a Relative Humidity of 20 to 70%.

High temperature and humidity conditions and/or prolonged storage may cause deterioration of the packaging materials. If more than six months have elapsed since delivery, check packaging, mounting, etc. before use.

In addition, this may cause oxidation of the electrodes. If more than one year has elapsed since delivery, also check the solderability before use.

1-2. Corrosive gas can react with the termination (external) electrodes or lead wires of capacitors, and result in poor solderability. Do not store the capacitors in an atmosphere consisting of corrosive gas (e.g., hydrogen sulfide, sulfur dioxide, chlorine, ammonia gas, etc.).

1-3. Due to moisture condensation caused by rapid humidity changes, or the photochemical change caused by direct sunlight on the terminal electrodes and/or the resin/epoxy coatings, the solderability and electrical performance may deteriorate. Do not store capacitors under direct sunlight or in high humidity conditions.

Rating

1. Temperature Dependent Characteristics

1. The electrical characteristics of a capacitor can change with temperature.

1-1. For capacitors having larger temperature dependency, the capacitance may change with temperature changes.

The following actions are recommended in order to ensure suitable capacitance values.

(1) Select a suitable capacitance for the operating temperature range.

(2) The capacitance may change within the rated temperature.

When you use a high dielectric constant type capacitor in a circuit that needs a tight (narrow) capacitance tolerance (e.g., a time-constant circuit), please carefully consider the temperature characteristics, and carefully confirm the various characteristics in actual use conditions and the actual system.

[Example of Temperature Characteristics X7R (R7)]

Sample: 0.1μF, Rated Voltage 50VDC

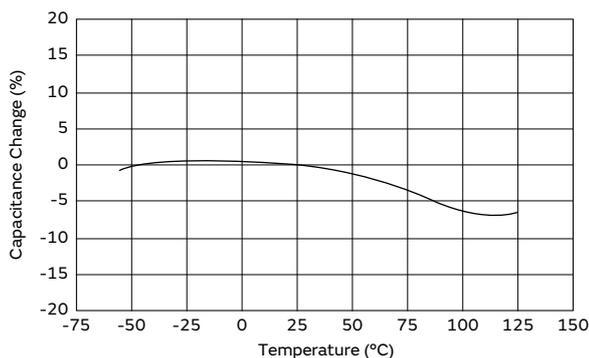

[Example of Temperature Characteristics X5R (R6)]

Sample: 22μF, Rated Voltage 4VDC

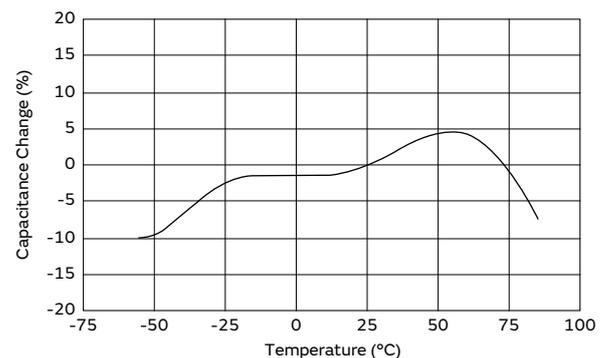

2. Measurement of Capacitance

1. Measure capacitance with the voltage and frequency specified in the product specifications.

1-1. The output voltage of the measuring equipment may decrease occasionally when capacitance is high. Please confirm whether a prescribed measured voltage is impressed to the capacitor.

1-2. The capacitance values of high dielectric constant type capacitors change depending on the AC voltage applied. Please consider the AC voltage characteristics when selecting a capacitor to be used in an AC circuit.

Continued on the following page. ↗

Caution

Continued from the preceding page. ↘

3. Applied Voltage and Applied Current

1. Do not apply a voltage to the capacitor that exceeds the rated voltage as called out in the specifications.
 - 1-1. Applied voltage between the terminals of a capacitor shall be less than or equal to the rated voltage.
 - (1) When AC voltage is superimposed on DC voltage, the zero-to-peak voltage shall not exceed the rated DC voltage.
 When AC voltage or pulse voltage is applied, the peak-to-peak voltage shall not exceed the rated DC voltage.
 - (2) Abnormal voltages (surge voltage, static electricity, pulse voltage, etc.) shall not exceed the rated DC voltage.

Typical Voltage Applied to the DC Capacitor

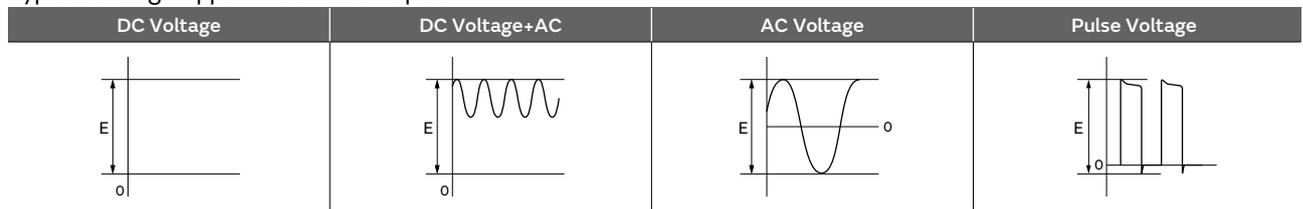

(E: Maximum possible applied voltage.)

- 1-2. Influence of over voltage
 Over voltage that is applied to the capacitor may result in an electrical short circuit caused by the breakdown of the internal dielectric layers. The time duration until breakdown depends on the applied voltage and the ambient temperature.
2. Use a safety standard certified capacitor in a power supply input circuit (AC filter), as it is also necessary to consider the withstand voltage and impulse withstand voltage defined for each device.

4. Type of Applied Voltage and Self-heating Temperature

1. Confirm the operating conditions to make sure that no large current is flowing into the capacitor due to the continuous application of an AC voltage or pulse voltage.
 When a DC rated voltage product is used in an AC voltage circuit or a pulse voltage circuit, the AC current or pulse current will flow into the capacitor; therefore check the self-heating condition.
 Please confirm the surface temperature of the capacitor so that the temperature remains within the upper limits of the operating temperature, including the rise in temperature due to self-heating. When the capacitor is used with a high-frequency voltage or pulse voltage, heat may be generated by dielectric loss.
<Applicable to Rated Voltage of less than 100VDC>
 - 1-1. The load should be contained so that the self-heating of the capacitor body remains below 20°C, when measuring at an ambient temperature of 25°C.

<Applicable to NFM Series>

3. The capacitors also have rated currents.
 The current flowing between the terminals of a capacitor shall be less than or equal to the rated current. Using the capacitor beyond this range could lead to excessive heat.

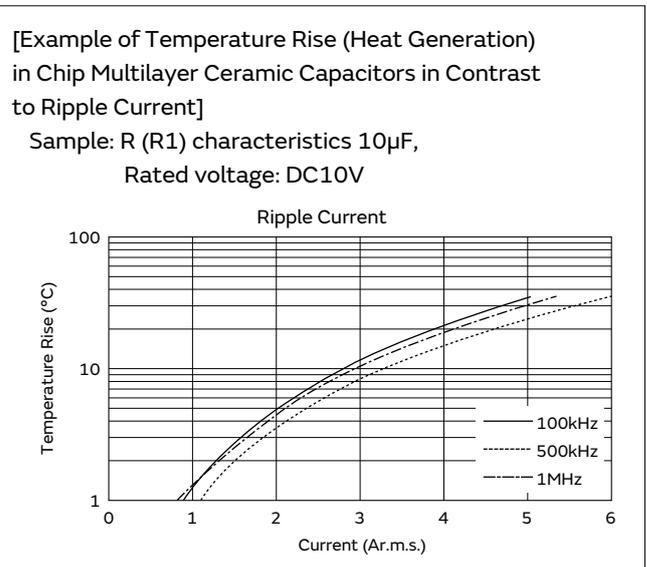

Continued on the following page. ↗

⚠Caution

Continued from the preceding page. ↘

<Applicable to Temperature Characteristics X7R (R7), X7T (D7), X7T (W0) beyond Rated Voltage of 200VDC>

1-2. The load should be contained so that the self-heating of the capacitor body remains below 20°C, when measuring at an ambient temperature of 25°C. In addition, use a K thermocouple of $\phi 0.1\text{mm}$ with less heat capacity when measuring, and measure in a condition where there is no effect from the radiant heat of other components or air flow caused by convection. Excessive generation of heat may cause deterioration of the characteristics and reliability of the capacitor. (Absolutely do not perform measurements while the cooling fan is operating, as an accurate measurement may not be performed.)

<Applicable to Temperature Characteristics U2J (7U), COG (5C) beyond Rated Voltage of 200VDC>

1-3. Since the self-heating is low in the low loss series, the allowable power becomes extremely high compared to the common X7R (R7) characteristics. However, when a load with self-heating of 20°C is applied at the rated voltage, the allowable power may be exceeded. When the capacitor is used in a high-frequency voltage circuit of 1kHz or more, the frequency of the applied voltage should be less than 500kHz sine wave (less than 100kHz for a product with rated voltage of DC3.15kV), to limit the voltage load so that the load remains within the derating shown in the following figure. In the case of non-sine wave, high-frequency components exceeding the fundamental frequency may be included. In such a case, please contact Murata. The excessive generation of heat may cause deterioration of the characteristics and reliability of the capacitor. (Absolutely do not perform measurements while the cooling fan is operating, as an accurate measurement may not be performed.)

[The sine-wave frequency VS allowable voltage]

The surface temperature of the capacitor: 125°C or less (including self-heating)

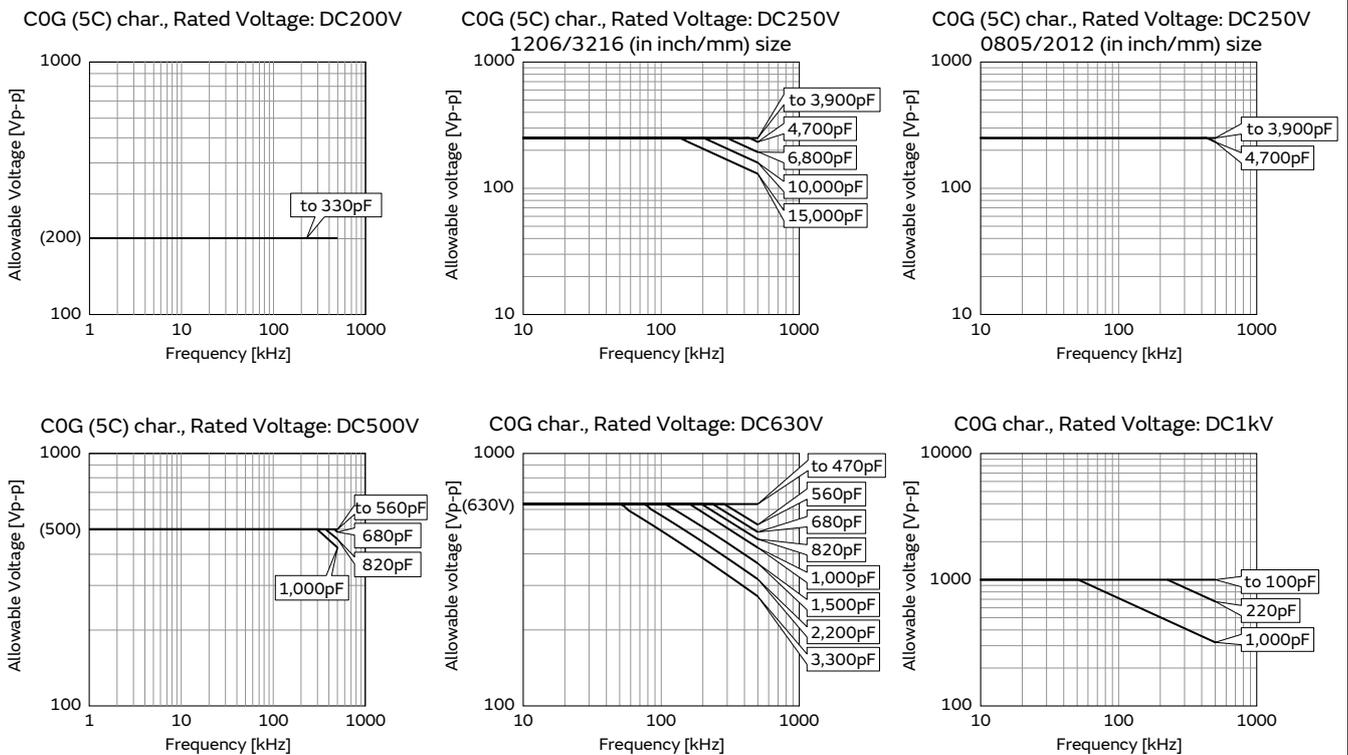

Continued on the following page. ↗

GRM

GR3

GRJ

GR4

GR7

GJM

GQM

GA2

GA3

GB

GA3

GD

GA3

GF

LLL

LLA

LLM

LLR

NFM

KRM

KR3

GMA

GMD

⚠Caution

⚠Caution

Continued from the preceding page. ↘

[The sine-wave frequency VS allowable voltage]

The surface temperature of the capacitor: 125°C or less
 (including self-heating)

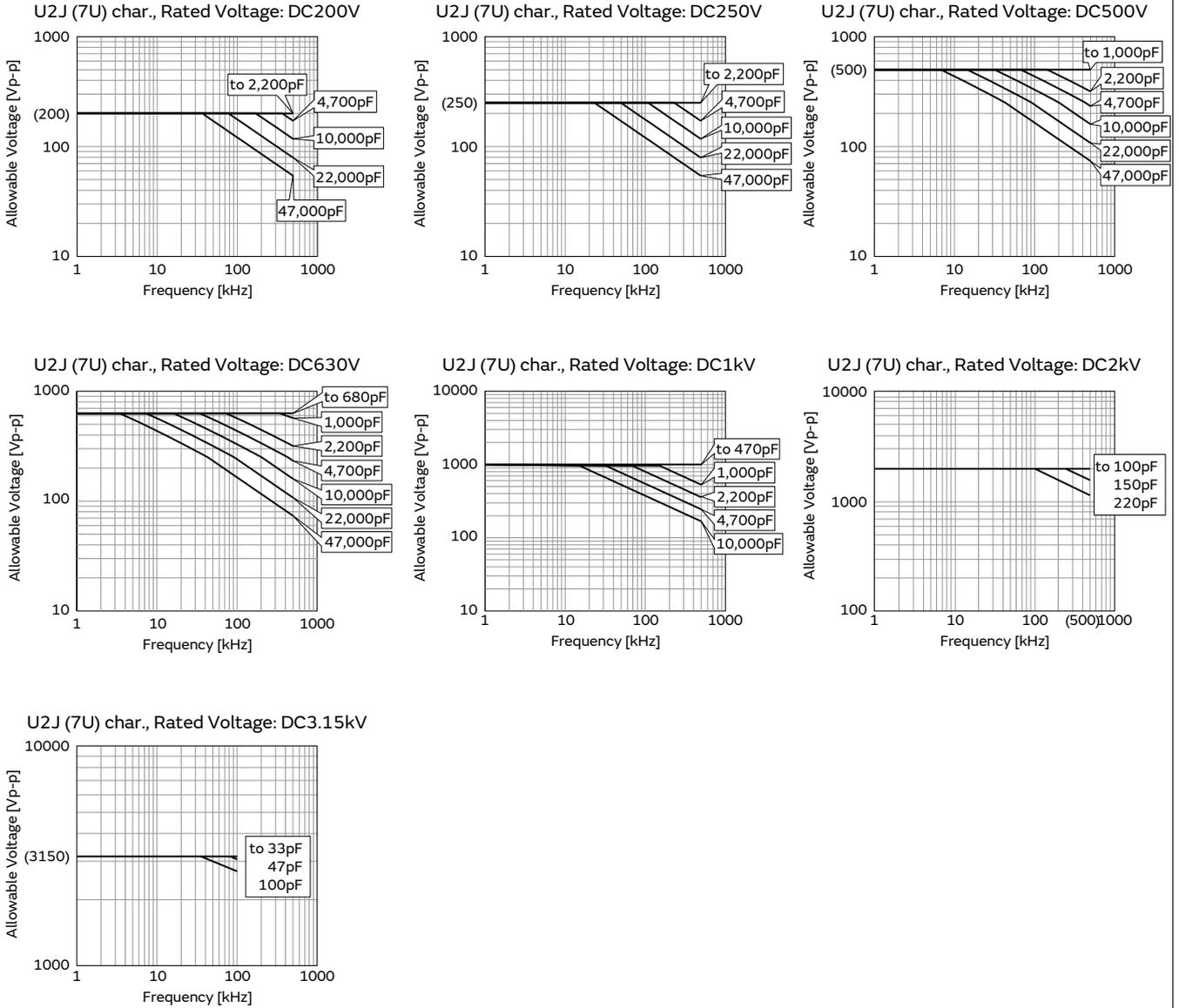

Continued on the following page. ↗

- GRM
- GR3
- GRJ
- GR4
- GR7
- GJM
- GQM
- GA2
- GA3 GB
- GA3 GD
- GA3 GF
- LLL
- LLA
- LLM
- LLR
- NFM
- KRM
- KR3
- GMA
- GMD

⚠Caution

Continued from the preceding page. ↘

5. DC Voltage and AC Voltage Characteristics

1. The capacitance value of a high dielectric constant type capacitor changes depending on the DC voltage applied. Please consider the DC voltage characteristics when a capacitor is selected for use in a DC circuit.

1-1. The capacitance of ceramic capacitors may change sharply depending on the applied voltage (see figure). Please confirm the following in order to secure the capacitance.

- (1) Determine whether the capacitance change caused by the applied voltage is within the allowed range.
- (2) In the DC voltage characteristics, the rate of capacitance change becomes larger as voltage increases, even if the applied voltage is below the rated voltage. When a high dielectric constant type capacitor is used in a circuit that requires a tight (narrow) capacitance tolerance (e.g., a time constant circuit), please carefully consider the voltage characteristics, and confirm the various characteristics in the actual operating conditions of the system.

2. The capacitance values of high dielectric constant type capacitors changes depending on the AC voltage applied. Please consider the AC voltage characteristics when selecting a capacitor to be used in an AC circuit.

6. Capacitance Aging

1. The high dielectric constant type capacitors have an Aging characteristic in which the capacitance value decreases with the passage of time. When you use high dielectric constant type capacitors in a circuit that needs a tight (narrow) capacitance tolerance (e.g., a time-constant circuit), please carefully consider the characteristics of these capacitors, such as their aging, voltage, and temperature characteristics. In addition, check capacitors using your actual appliances at the intended environment and operating conditions.

[Example of DC Voltage Characteristics]
 Sample: X7R (R7) Characteristics 0.1μF,
 Rated Voltage 50VDC

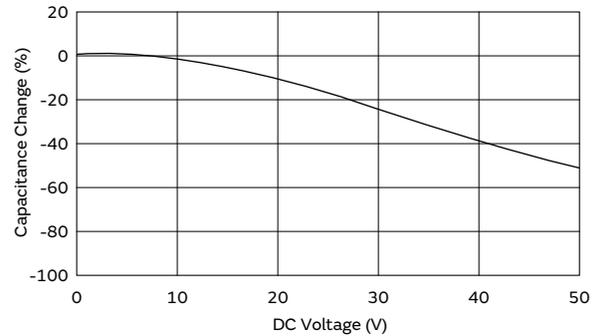

[Example of AC Voltage Characteristics]
 Sample: X7R (R7) Characteristics 10μF,
 Rated Voltage 6.3VDC

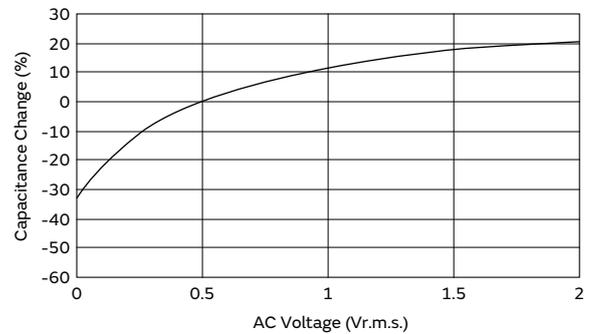

[Example of Change Over Time (Aging Characteristics)]

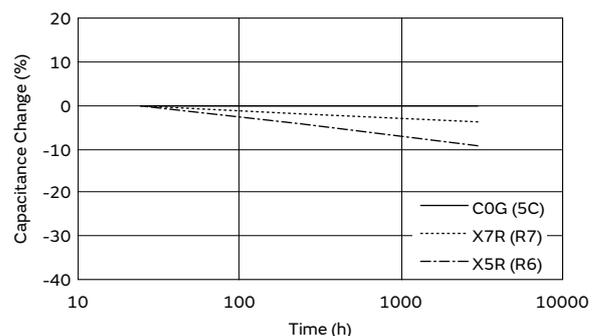

Continued on the following page. ↗

GRM

GR3

GRJ

GR4

GR7

GJM

GQM

GA2

GA3 GB

GA3 GD

GA3 GF

LLL

LLA

LLM

LLR

NFM

KRM

KR3

GMA

GMD

⚠Caution

⚠Caution

Continued from the preceding page. ↘

7. Vibration and Shock

1. Please confirm the kind of vibration and/or shock, its condition, and any generation of resonance.
 Please mount the capacitor so as not to generate resonance, and do not allow any impact on the terminals.
2. Mechanical shock due to being dropped may cause damage or a crack in the dielectric material of the capacitor.
 Do not use a dropped capacitor because the quality and reliability may be deteriorated.
3. When printed circuit boards are piled up or handled, the corner of another printed circuit board should not be allowed to hit the capacitor, in order to avoid a crack or other damage to the capacitor.

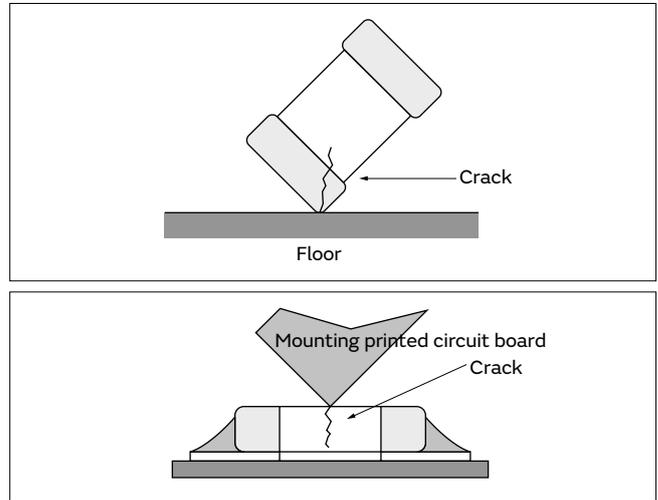

Soldering and Mounting

1. Mounting Position

1. Confirm the best mounting position and direction that minimizes the stress imposed on the capacitor during flexing or bending the printed circuit board.
 - 1-1. Choose a mounting position that minimizes the stress imposed on the chip during flexing or bending of the board.

<Applicable to NFM Series>

2. If you mount the capacitor near components that generate heat, take note of the heat from the other components and carefully check the self-heating of the capacitor before using.
 If there is significant heat radiation from other components, it could lower the insulation resistance of the capacitor or produce excessive heat.

[Component Direction]

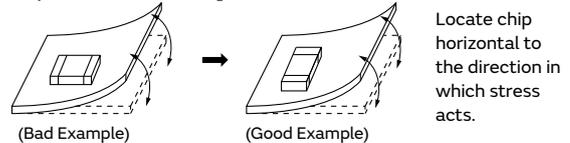

[Chip Mounting Close to Board Separation Point]

It is effective to implement the following measures, to reduce stress in separating the board.

It is best to implement all of the following three measures; however, implement as many measures as possible to reduce stress.

Contents of Measures	Stress Level
(1) Turn the mounting direction of the component parallel to the board separation surface.	A > D *1
(2) Add slits in the board separation part.	A > B
(3) Keep the mounting position of the component away from the board separation surface.	A > C

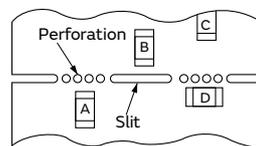

*1 A > D is valid when stress is added vertically to the perforation as with Hand Separation.
 If a Cutting Disc is used, stress will be diagonal to the PCB, therefore A > D is invalid.

[Mounting Capacitors Near Screw Holes]

When a capacitor is mounted near a screw hole, it may be affected by the board deflection that occurs during the tightening of the screw. Mount the capacitor in a position as far away from the screw holes as possible.

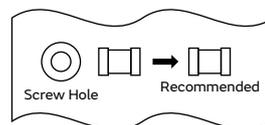

Continued on the following page. ↗

GRM
 GR3
 GRJ
 GR4
 GR7
 GJM
 GQM
 GA2
 GA3 GB
 GA3 GD
 GA3 GF
 LLL
 LLA
 LLM
 LLR
 NFM
 KPM
 KR3
 GMA
 GMD
 ⚠Caution

⚠Caution

Continued from the preceding page. ↘

2. Information before Mounting

1. Do not re-use capacitors that were removed from the equipment.
2. Confirm capacitance characteristics under actual applied voltage.
3. Confirm the mechanical stress under actual process and equipment use.
4. Confirm the rated capacitance, rated voltage and other electrical characteristics before assembly.
5. Prior to use, confirm the solderability of capacitors that were in long-term storage.
6. Prior to measuring capacitance, carry out a heat treatment for capacitors that were in long-term storage.
7. The use of Sn-Zn based solder will deteriorate the reliability of the MLCC.
 Please contact our sales representative or product engineers on the use of Sn-Zn based solder in advance.
8. We have also produced a DVD which shows a summary of our recommendations, regarding the precautions for mounting. Please contact our sales representative to request the DVD.

3. Maintenance of the Mounting (pick and place) Machine

1. Make sure that the following excessive forces are not applied to the capacitors. Check the mounting in the actual device under actual use conditions ahead of time.
 - 1-1. In mounting the capacitors on the printed circuit board, any bending force against them shall be kept to a minimum to prevent them from any damage or cracking. Please take into account the following precautions and recommendations for use in your process.
 - (1) Adjust the lowest position of the pickup nozzle so as not to bend the printed circuit board.
2. Dirt particles and dust accumulated in the suction nozzle and suction mechanism prevent the nozzle from moving smoothly. This creates excessive force on the capacitor during mounting, causing cracked chips. Also, the locating claw, when worn out, imposes uneven forces on the chip when positioning, causing cracked chips. The suction nozzle and the locating claw must be maintained, checked, and replaced periodically.

<Applicable to ZRB Series>

3. To adjust the inspection tolerance for automated appearance sorting machine of mounting position, because ZRB series are easier to shift the mounting position than standard MLCC.
4. To check the overturn and reverse of chip.
5. To control mounting speed carefully, because ZRB series is heavier than standard MLCC.

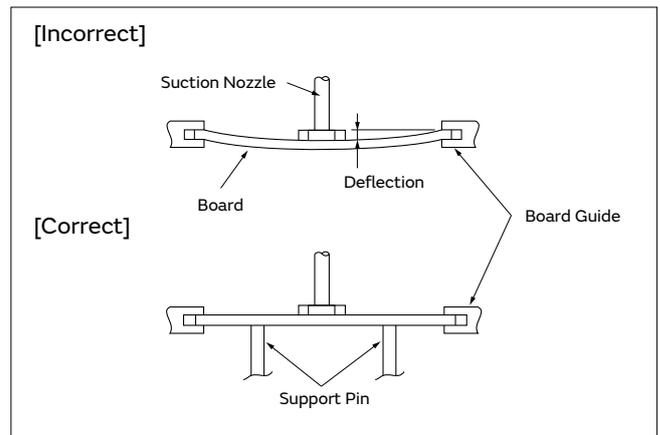

Continued on the following page. ↗

⚠Caution

Continued from the preceding page. ↘

4-1. Reflow Soldering

1. When sudden heat is applied to the components, the mechanical strength of the components will decrease because a sudden temperature change causes deformation inside the components. In order to prevent mechanical damage to the components, preheating is required for both the components and the PCB. Preheating conditions are shown in table 1. It is required to keep the temperature differential between the solder and the components surface (ΔT) as small as possible.
2. When components are immersed in solvent after mounting, be sure to maintain the temperature difference (ΔT) between the component and the solvent within the range shown in table 1.

Table 1

Series	Chip Dimension Code (L/W)	Temperature Differential
GRM/GJM/GQM/GR3/GRJ/KRM/LLR/NFM/GR7	02/03/15/18/21/31	$\Delta T \leq 190^\circ\text{C}$
LLL	02/03/15/18/1U/21/31	
ZRB	15/18	
GR3/GRJ/GRM/KR3/KRM GA2/GA3/GR4	32/42/43/52/55	$\Delta T \leq 130^\circ\text{C}$
LLA/LLM	18/21/31	
GQM	22	

Recommended Conditions

	Pb-Sn Solder	Lead Free Solder
Peak Temperature	230 to 250°C	240 to 260°C
Atmosphere	Air	Air or N ₂

Pb-Sn Solder: Sn-37Pb
 Lead Free Solder: Sn-3.0Ag-0.5Cu

3. When a capacitor is mounted at a temperature lower than the peak reflow temperature recommended by the solder manufacturer, the following quality problems can occur. Consider factors such as the placement of peripheral components and the reflow temperature setting to prevent the capacitor's reflow temperature from dropping below the peak temperature specified. Be sure to evaluate the mounting situation beforehand and verify that none of the following problems occur.
 - Drop in solder wettability
 - Solder voids
 - Possible occurrence of whiskering
 - Drop in bonding strength
 - Drop in self-alignment properties
 - Possible occurrence of tombstones and/or shifting on the land patterns of the circuit board

[Example of Temperature Conditions for Reflow Soldering]

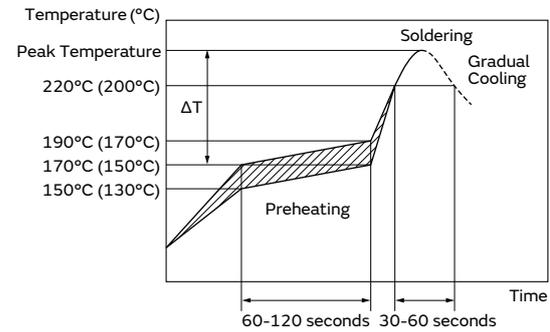

Temperature
 Incase of Lead Free Solder
 (): In case of Pb-Sn Solder

[Allowable Reflow Soldering Temperature and Time]

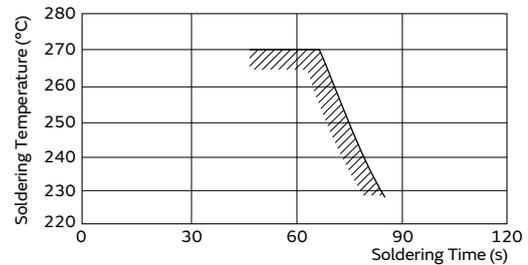

In the case of repeated soldering, the accumulated soldering time must be within the range shown above.

Continued on the following page. ↗

GRM
 GR3
 GRJ
 GR4
 GR7
 GJM
 GQM
 GA2
 GA3 GB
 GA3 GD
 GA3 GF
 LLL
 LLA
 LLM
 LLR
 NFM
 KRM
 KR3
 GMA
 GMD
 ⚠Caution

Caution

Continued from the preceding page. ↘

4. Optimum Solder Amount for Reflow Soldering

- 4-1. Overly thick application of solder paste results in a excessive solder fillet height.
 This makes the chip more susceptible to mechanical and thermal stress on the board and may cause the chips to crack.
- 4-2. Too little solder paste results in a lack of adhesive strength on the termination, which may result in chips breaking loose from the PCB.
- 4-3. Please confirm that solder has been applied smoothly to the termination.

<Applicable to NFM Series>

[Guideline of solder paste thickness]
 100-150 μ m: NFM15/18/21/3D/31
 100-200 μ m: NFM41

NFM15CC/15PC

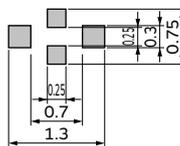

NFM18CC/18PC

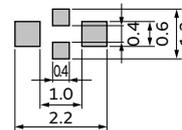

NFM18PS

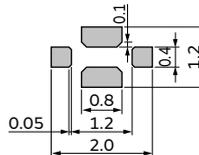

NFM21CC/21PC

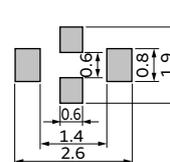

NFM21PS

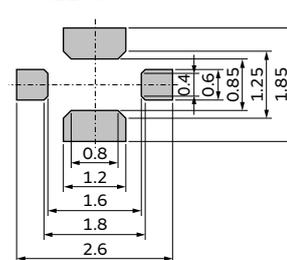

NFM3DCC/3DPC

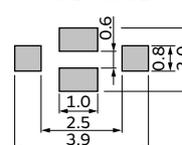

NFM31PC/31KC

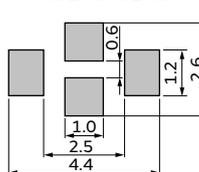

NFM41CC/41PC

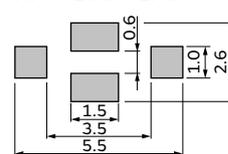

Inverting the PCB

Make sure not to impose any abnormal mechanical shocks to the PCB.

Continued on the following page. ↗

- GRM
- GR3
- GRJ
- GR4
- GR7
- GJM
- GQM
- GA2
- GA3 GB
- GA3 GD
- GA3 GF
- LLL
- LLA
- LLM
- LLR
- NFM
- KRM
- KR3
- GMA
- GMD
- Caution

Caution

Continued from the preceding page. ↘

4-2. Flow Soldering

1. Do not apply flow soldering to chips not listed in table 2.

Table 2

Series	Chip Dimension Code (L/W)	Temperature Differential
GR3/GRM	18/21/31	$\Delta T \leq 150^\circ\text{C}$
GQM	18/21	
LLL	21/31	
GRJ	18/21/31	
NFM	3D/31/41	

- When sudden heat is applied to the components, the mechanical strength of the components will decrease because a sudden temperature change causes deformation inside the components. In order to prevent mechanical damage to the components, preheating is required for both of the components and the PCB. Preheating conditions are shown in table 2. It is required to keep the temperature differential between the solder and the components surface (ΔT) as low as possible.
- Excessively long soldering time or high soldering temperature can result in leaching of the terminations, causing poor adhesion or a reduction in capacitance value due to loss of contact between the inner electrodes and terminations.
- When components are immersed in solvent after mounting, be sure to maintain the temperature differential (ΔT) between the component and solvent within the range shown in the table 2.

Recommended Conditions

	Pb-Sn Solder	Lead Free Solder
Preheating Peak Temperature	90 to 110°C	100 to 120°C 140 to 160°C (NFM)
Soldering Peak Temperature	240 to 250°C	250 to 260°C
Atmosphere	Air	Air or N ₂

Pb-Sn Solder: Sn-37Pb

Lead Free Solder: Sn-3.0Ag-0.5Cu

5. Optimum Solder Amount for Flow Soldering

- The top of the solder fillet should be lower than the thickness of the components. If the solder amount is excessive, the risk of cracking is higher during board bending or any other stressful condition.

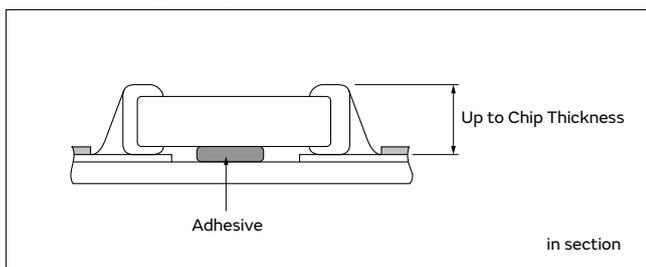

[Example of Temperature Conditions for Flow Soldering]

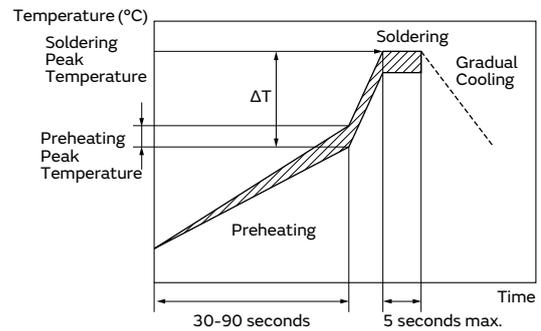

[Allowable Flow Soldering Temperature and Time]

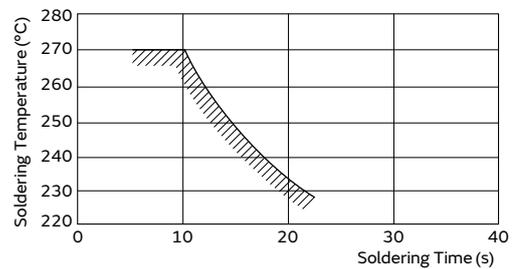

In the case of repeated soldering, the accumulated soldering time must be within the range shown above.

Continued on the following page. ↗

- GRM
- GR3
- GRJ
- GR4
- GR7
- GJM
- GQM
- GA2
- GA3 GB
- GA3 GD
- GA3 GF
- LLL
- LLA
- LLM
- LLR
- NFM
- KRM
- KR3
- GMA
- GMD
- Caution

⚠Caution

Continued from the preceding page. ↘

4-3. Correction of Soldered Portion

When sudden heat is applied to the capacitor, distortion caused by the large temperature difference occurs internally, and can be the cause of cracks. Capacitors also tend to be affected by mechanical and thermal stress depending on the board preheating temperature or the soldering fillet shape, and can be the cause of cracks. Please refer to "1. PCB Design" or "3. Optimum solder amount" for the solder amount and the fillet shapes.

Do not correct with a soldering iron for ZRB series.

Correction with a soldering iron for ZRB series may cause loss suppress acoustic noise, because the solder amount become excessive.

1. Correction with a Soldering Iron

1-1. In order to reduce damage to the capacitor, be sure to preheat the capacitor and the mounting board. Preheat to the temperature range shown in Table 3. A hot plate, hot air type preheater, etc. can be used for preheating.

1-2. After soldering, do not allow the component/PCB to cool down rapidly.

1-3. Perform the corrections with a soldering iron as quickly as possible. If the soldering iron is applied too long, there is a possibility of causing solder leaching on the terminal electrodes, which will cause deterioration of the adhesive strength and other problems.

Table 3

Series	Chip Dimension Code (L/W)	Temperature of Soldering Iron Tip	Preheating Temperature	Temperature Differential (ΔT)	Atmosphere
GJM/GQM/GR3/GRJ/GRM/GR7	03/15/18/21/31	350°C max.	150°C min.	$\Delta T \leq 190^\circ\text{C}$	Air
GRJ/GRM/GR4/GA2/GA3	32/42/43/52/55	280°C max.	150°C min.	$\Delta T \leq 130^\circ\text{C}$	Air
GQM	22				
NFM	3D/41	350°C max.	150°C min.	$\Delta T \leq 190^\circ\text{C}$	Air
	15	340°C max.			

*Applicable for both Pb-Sn and Lead Free Solder.

Pb-Sn Solder: Sn-37Pb

Lead Free Solder: Sn-3.0Ag-0.5Cu

*Please manage ΔT in the temperature of soldering iron and the preheating temperature.

2. Correction with Spot Heater

Compared to local heating with a soldering iron, hot air heating by a spot heater heats the overall component and board, therefore, it tends to lessen the thermal shock. In the case of a high density mounted board, a spot heater can also prevent concerns of the soldering iron making direct contact with the component.

2-1. If the distance from the hot air outlet of the spot heater to the component is too close, cracks may occur due to thermal shock. To prevent this problem, follow the conditions shown in Table 4.

2-2. In order to create an appropriate solder fillet shape, it is recommended that hot air be applied at the angle shown in Figure 1.

Table 4

Distance	5mm or more
Hot Air Application Angle	45° *Figure 1
Hot Air Temperature Nozzle Outlet	400°C max.
Application Time	Less than 10 seconds (1206 (3216M) size or smaller)
	Less than 30 seconds (1210 (3225M) size or larger)

[*Figure 1]

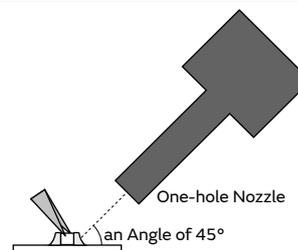

3. Optimum solder amount when re-working with a soldering iron

3-1. If the solder amount is excessive, the risk of cracking is higher during board bending or any other stressful condition.

Too little solder amount results in a lack of adhesive strength on the termination, which may result in chips breaking loose from the PCB.

Please confirm that solder has been applied smoothly and rising to the end surface of the chip.

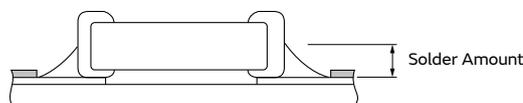

in section

Continued on the following page. ↗

⚠Caution

Continued from the preceding page. ↘

- 3-2. A soldering iron with a tip of $\varnothing 3\text{mm}$ or smaller should be used. It is also necessary to keep the soldering iron from touching the components during the re-work.
- 3-3. Solder wire with $\varnothing 0.5\text{mm}$ or smaller is required for soldering.

<Applicable to KR3/KRM Series>

4. For the shape of the soldering iron tip, refer to the figure on the right.

Regarding the type of solder, use a wire diameter of $\varnothing 0.5\text{mm}$ or less (rosin core wire solder).

4-1. How to Apply the Soldering Iron

Apply the tip of the soldering iron against the lower end of the metal terminal.

- 1) In order to prevent cracking caused by sudden heating of the ceramic device, do not touch the ceramic base directly.
- 2) In order to prevent deviations and dislocating of the chip, do not touch the junction of the chip and the metal terminal, and the metal portion on the outside directly.

4-2. Appropriate Amount of Solder

The amount of solder for corrections by soldering iron, should be lower than the height of the lower side of the chip.

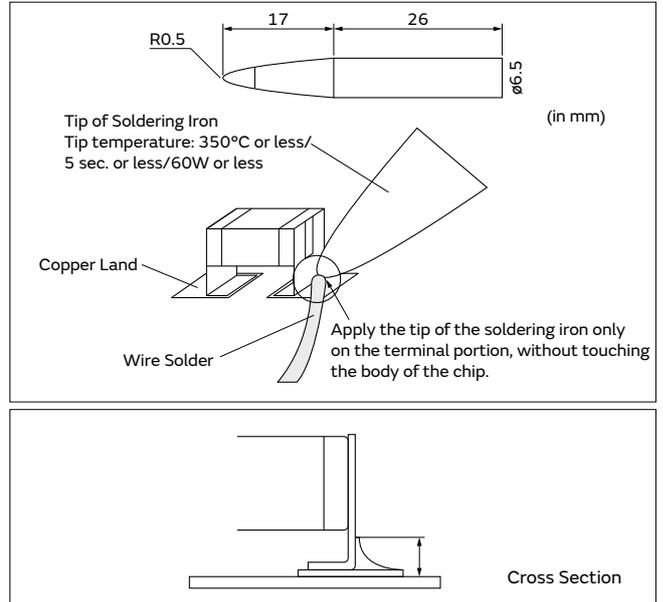

5. Washing

Excessive ultrasonic oscillation during cleaning can cause the PCBs to resonate, resulting in cracked chips or broken solder joints. Before starting your production process, test your cleaning equipment/process to insure it does not degrade the capacitors.

6. Electrical Test on Printed Circuit Board

1. Confirm position of the support pin or specific jig, when inspecting the electrical performance of a capacitor after mounting on the printed circuit board.

1-1. Avoid bending the printed circuit board by the pressure of a test-probe, etc.

The thrusting force of the test probe can flex the PCB, resulting in cracked chips or open solder joints. Provide support pins on the back side of the PCB to prevent warping or flexing. Install support pins as close to the test-probe as possible.

1-2. Avoid vibration of the board by shock when a test-probe contacts a printed circuit board.

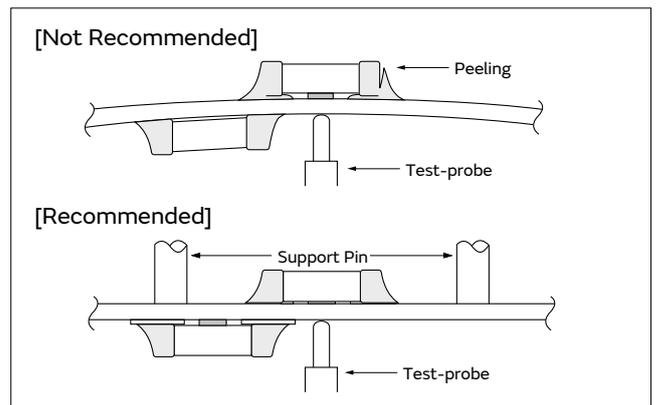

7. Printed Circuit Board Cropping

1. After mounting a capacitor on a printed circuit board, do not apply any stress to the capacitor that causes bending or twisting the board.

- 1-1. In cropping the board, the stress as shown at right may cause the capacitor to crack. Cracked capacitors may cause deterioration of the insulation resistance, and result in a short. Avoid this type of stress to a capacitor.

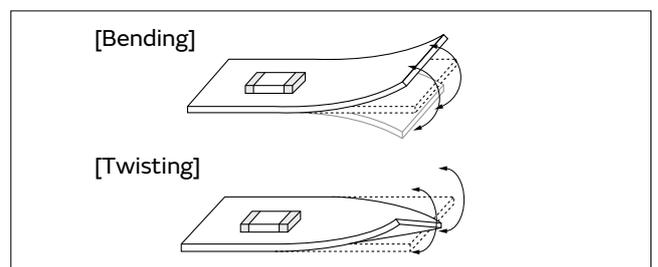

Continued on the following page. ↗

⚠Caution

Continued from the preceding page. ↘

2. Check the cropping method for the printed circuit board in advance.

2-1. Printed circuit board cropping shall be carried out by using a jig or an apparatus (Disc separator, router type separator, etc.) to prevent the mechanical stress that can occur to the board.

Board Separation Method	Hand Separation Nipper Separation	(1) Board Separation Jig	Board Separation Apparatus	
			(2) Disc Separator	(3) Router Type Separator
Level of stress on board	High	Medium	Medium	Low
Recommended	×	△*	△*	○
Notes	Hand and nipper separation apply a high level of stress. Use another method.	<ul style="list-style-type: none"> Board handling Board bending direction Layout of capacitors 	<ul style="list-style-type: none"> Board handling Layout of slits Design of V groove Arrangement of blades Controlling blade life 	Board handling

* When a board separation jig or disc separator is used, if the following precautions are not observed, a large board deflection stress will occur and the capacitors may crack. Use router type separator if at all possible.

(1) Example of a suitable jig

[In the case of Single-side Mounting]

An outline of the board separation jig is shown as follows. Recommended example: Stress on the component mounting position can be minimized by holding the portion close to the jig, and bend in the direction towards the side where the capacitors are mounted. Not recommended example: The risk of cracks occurring in the capacitors increases due to large stress being applied to the component mounting position, if the portion away from the jig is held and bent in the direction opposite the side where the capacitors are mounted.

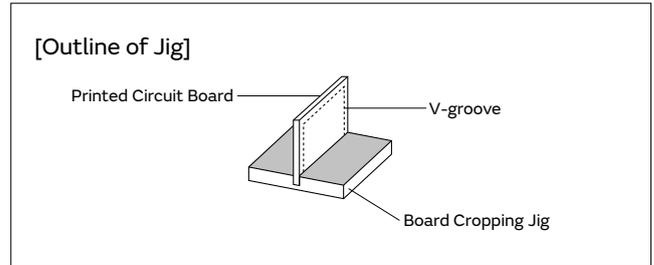

Hand Separation

Recommended	Not Recommended

[In the case of Double-sided Mounting]

Since components are mounted on both sides of the board, the risk of cracks occurring can not be avoided with the above method. Therefore, implement the following measures to prevent stress from being applied to the components.

(Measures)

- (1) Consider introducing a router type separator. If it is difficult to introduce a router type separator, implement the following measures. (Refer to item 1. Mounting Position)
- (2) Mount the components parallel to the board separation surface.
- (3) When mounting components near the board separation point, add slits in the separation position near the component.
- (4) Keep the mounting position of the components away from the board separation point.

Continued on the following page. ↗

GRM
GR3
GRJ
GR4
GR7
GJM
GQM
GA2
GA3 GB
GA3 GD
GA3 GF
LLL
LLA
LLM
LLR
NFM
KRM
KR3
GMA
GMD
⚠Caution

⚠Caution

Continued from the preceding page. ↘

(2) Example of a Disc Separator

An outline of a disc separator is shown as follows. As shown in the Principle of Operation, the top blade and bottom blade are aligned with the V-grooves on the printed circuit board to separate the board.

In the following case, board deflection stress will be applied and cause cracks in the capacitors.

- (1) When the adjustment of the top and bottom blades are misaligned, such as deviating in the top-bottom, left-right or front-rear directions
- (2) The angle of the V groove is too low, depth of the V groove is too shallow, or the V groove is misaligned top-bottom

IF V groove is too deep, it is possible to brake when you handle and carry it. Carefully design depth of the V groove with consideration about strength of material of the printed circuit board.

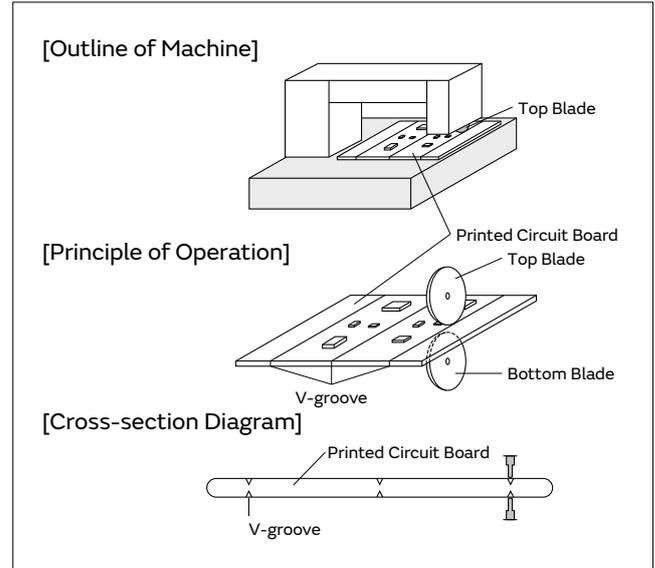

Disc Separator

Recommended	Not Recommended		
	Top-bottom Misalignment	Left-right Misalignment	Front-rear Misalignment
<p>Top Blade</p> <p>Bottom Blade</p>	<p>Top Blade</p> <p>Bottom Blade</p>	<p>Top Blade</p> <p>Bottom Blade</p>	<p>Top Blade</p> <p>Bottom Blade</p>

V-groove Design

Example of Recommended V-groove Design	Not Recommended			
	Left-right Misalignment	Low-Angle	Depth too Shallow	Depth too Deep

(3) Example of Router Type Separator

The router type separator performs cutting by a router rotating at a high speed. Since the board does not bend in the cutting process, stress on the board can be suppressed during board separation.

When attaching or removing boards to/from the router type separator, carefully handle the boards to prevent bending.

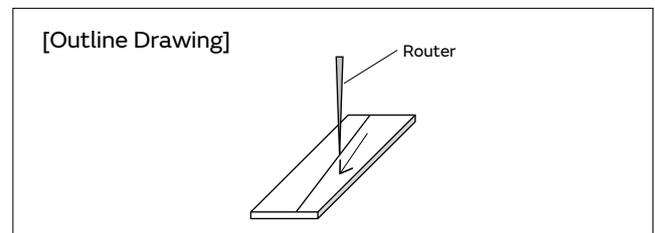

Continued on the following page. ↗

GRM
 GR3
 GRJ
 GR4
 GR7
 GJM
 GQM
 GA2
 GA3 GB
 GA3 GD
 GA3 GF
 LLL
 LLA
 LLM
 LLR
 NFM
 KRM
 KR3
 GMA
 GMD
 ⚠Caution

GRM
GR3
GRJ
GR4
GR7
GJM
GQM
GA2
GA3
GA3
GA3
LLL
LLA
LLM
LLR
NFM
KRM
KR3
GMA
GMD
Caution

⚠Caution

Continued from the preceding page. ↘

8. Assembly

1. Handling

If a board mounted with capacitors is held with one hand, the board may bend. Firmly hold the edges of the board with both hands when handling.

If a board mounted with capacitors is dropped, cracks may occur in the capacitors.

Do not use dropped boards, as there is a possibility that the quality of the capacitors may be impaired.

2. Attachment of Other Components

2-1. Mounting of Other Components

Pay attention to the following items, when mounting other components on the back side of the board after capacitors have been mounted on the opposite side.

When the bottom dead point of the suction nozzle is set too low, board deflection stress may be applied to the capacitors on the back side (bottom side), and cracks may occur in the capacitors.

- After the board is straightened, set the bottom dead point of the nozzle on the upper surface of the board.
- Periodically check and adjust the bottom dead point.

2-2. Inserting Components with Leads into Boards

When inserting components (transformers, IC, etc.) into boards, bending the board may cause cracks in the capacitors or cracks in the solder.

Pay attention to the following.

- Increase the size of the holes to insert the leads, to reduce the stress on the board during insertion.
- Fix the board with support pins or a dedicated jig before insertion.
- Support below the board so that the board does not bend. When using support pins on the board, periodically confirm that there is no difference in the height of each support pin.

2-3. Attaching/Removing Sockets and/or Connectors

Insertion and removal of sockets and connectors, etc., might cause the board to bend. Please insure that the board does not warp during insertion and removal of sockets and connectors, etc., or the bending may damage mounted components on the board.

2-4. Tightening Screws

The board may be bent, when tightening screws, etc. during the attachment of the board to a shield or chassis.

Pay attention to the following items before performing the work.

- Plan the work to prevent the board from bending.
- Use a torque screwdriver, to prevent over-tightening of the screws.
- The board may bend after mounting by reflow soldering, etc. Please note, as stress may be applied to the chips by forcibly flattening the board when tightening the screws.

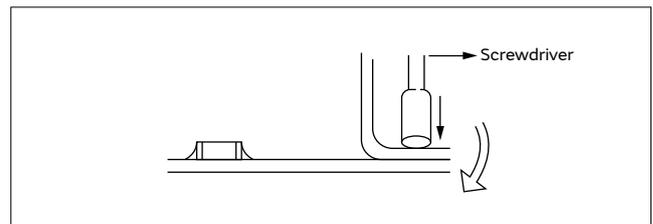
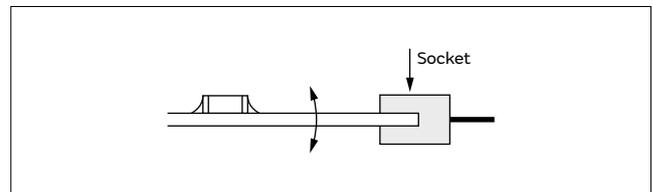
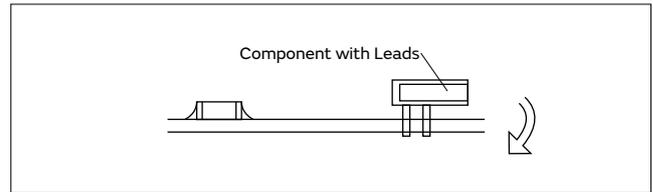
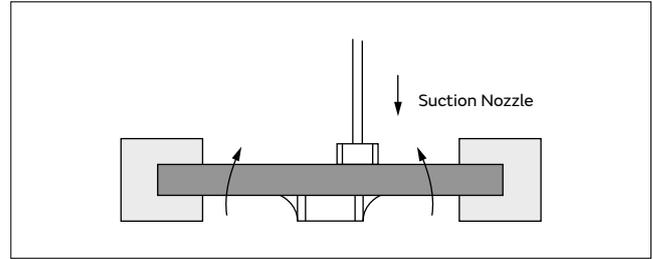

⚠Caution

Continued from the preceding page. ↘

<Applicable to GMA or GMD Series>

9. Die Bonding/Wire Bonding

1. Die Bonding of Capacitors

1-1. Use the following materials for the Brazing alloys:

Au-Sn (80/20) 300 to 320 °C in N₂ atmosphere

1-2. Mounting

- (1) Control the temperature of the substrate so it matches the temperature of the brazing alloy.
- (2) Place the brazing alloy on the substrate and place the capacitor on the alloy. Hold the capacitor and gently apply the load. Be sure to complete the operation within 1 minute.

2. Wire Bonding

2-1. Wire

Gold wire: 25 micro m (0.001 inch) diameter

2-2. Bonding

- (1) Thermo compression, ultrasonic ball bonding.
- (2) Required stage temperature: 150 to 200 °C
- (3) Required wedge or capillary weight: 0.2N to 0.5N
- (4) Bond the capacitor and base substrate or other devices with gold wire.

Other

1. Under Operation of Equipment

- 1-1. Do not touch a capacitor directly with bare hands during operation in order to avoid the danger of an electric shock.
- 1-2. Do not allow the terminals of a capacitor to come in contact with any conductive objects (short-circuit). Do not expose a capacitor to a conductive liquid, including any acid or alkali solutions.
- 1-3. Confirm the environment in which the equipment will operate is under the specified conditions. Do not use the equipment under the following environments.
 - (1) Being splattered with water or oil.
 - (2) Being exposed to direct sunlight.
 - (3) Being exposed to ozone, ultraviolet rays, or radiation.
 - (4) Being exposed to toxic gas (e.g., hydrogen sulfide, sulfur dioxide, chlorine, ammonia gas, etc.)
 - (5) Any vibrations or mechanical shocks exceeding the specified limits.
 - (6) Moisture condensing environments.
- 1-4. Use damp proof countermeasures if using under any conditions that can cause condensation.

Continued on the following page. ↗

GRM

GR3

GRJ

GR4

GR7

GJM

GQM

GA2

GA3

GA3

GA3

LLL

LLA

LLM

LLR

NFM

KRM

KR3

GMA

GMD

⚠Caution

⚠Caution

Continued from the preceding page. ↘

2. Other

2-1. In an Emergency

- (1) If the equipment should generate smoke, fire, or smell, immediately turn off or unplug the equipment.
If the equipment is not turned off or unplugged, the hazards may be worsened by supplying continuous power.
- (2) In this type of situation, do not allow face and hands to come in contact with the capacitor or burns may be caused by the capacitor's high temperature.

2-2. Disposal of Waste

When capacitors are disposed of, they must be burned or buried by an industrial waste vendor with the appropriate licenses.

2-3. Circuit Design

(1) Addition of Fail Safe Function

Capacitors that are cracked by dropping or bending of the board may cause deterioration of the insulation resistance, and result in a short.
If the circuit being used may cause an electrical shock, smoke or fire when a capacitor is shorted, be sure to install fail-safe functions, such as a fuse, to prevent secondary accidents.

- (2) Capacitors used to prevent electromagnetic interference in the primary AC side circuit, or as a connection/insulation, must be a safety standard certified product, or satisfy the contents stipulated in the Electrical Appliance and Material Safety Law. Install a fuse for each line in case of a short.
- (3) The GJM, GMA, GMD, GQM, GR3, GRJ, GRM, KR3, KRM, LLA, LLL, LLM, LLR, NFM and ZRB series are not safety standard certified products.

2-4. Test Condition for AC Withstanding Voltage

(1) Test Equipment

Test equipment for AC withstanding voltage should be made with equipment capable of creating a wave similar to a 50/60Hz sine wave.

(2) Voltage Applied Method

The capacitor's lead or terminal should be firmly connected to the output of the withstanding voltage test equipment, and then the voltage should be raised from near zero to the test voltage.

If the test voltage is applied directly to the capacitor without raising it from near zero, it should be applied with the zero cross. *At the end of the test time, the test voltage should be reduced to near zero, and then capacitor's lead or terminals should be taken off the output of the withstanding voltage test equipment.

If the test voltage applied directly to the capacitor without raising it from near zero, surge voltage may occur and cause a defect.

*ZERO CROSS is the point where voltage sine wave passes 0V. - See the figure at right -

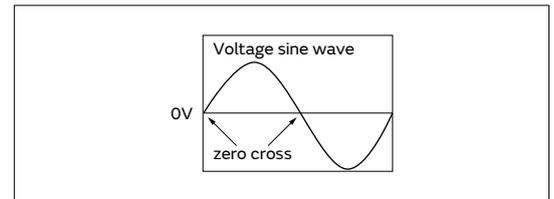

2-5. Remarks

Failure to follow the cautions may result, worst case, in a short circuit and smoking when the product is used.

The above notices are for standard applications and conditions. Contact us when the products are used in special mounting conditions.

Select optimum conditions for operation as they determine the reliability of the product after assembly.

The data herein are given in typical values, not guaranteed ratings.

GRM

GR3

GRJ

GR4

GR7

GJM

GQM

GA2

GA3
GB

GA3
GD

GA3
GF

LLL

LLA

LLM

LLR

NFM

KRM

KR3

GMA

GMD

⚠Caution

Notice

Rating

1. Operating Temperature

1. The operating temperature limit depends on the capacitor.

1-1. Do not apply temperatures exceeding the maximum operating temperature.

It is necessary to select a capacitor with a suitable rated temperature that will cover the operating temperature range.

It is also necessary to consider the temperature distribution in equipment and the seasonal temperature variable factor.

1-2. Consider the self-heating factor of the capacitor.

The surface temperature of the capacitor shall not exceed the maximum operating temperature including self-heating.

2. Atmosphere Surroundings (gaseous and liquid)

1. Restriction on the operating environment of capacitors.

1-1. Capacitors, when used in the above, unsuitable, operating environments may deteriorate due to the corrosion of the terminations and the penetration of moisture into the capacitor.

1-2. The same phenomenon as the above may occur when the electrodes or terminals of the capacitor are subject to moisture condensation.

1-3. The deterioration of characteristics and insulation resistance due to the oxidization or corrosion of terminal electrodes may result in breakdown when the capacitor is exposed to corrosive or volatile gases or solvents for long periods of time.

3. Piezo-electric Phenomenon

1. When using high dielectric constant type capacitors in AC or pulse circuits, the capacitor itself vibrates at specific frequencies and noise may be generated.

Moreover, when the mechanical vibration or shock is added to the capacitor, noise may occur.

Soldering and Mounting

1. PCB Design

1. Notice for Pattern Forms

1-1. Unlike leaded components, chip components are susceptible to flexing stresses since they are mounted directly on the substrate. They are also more sensitive to mechanical and thermal stresses than leaded components. Excess solder fillet height can multiply these stresses and cause chip cracking. When designing substrates, take land patterns and dimensions into consideration to eliminate the possibility of excess solder fillet height.

1-2. There is a possibility of chip cracking caused by PCB expansion/contraction with heat, because stress on a chip is different depending on PCB material and structure. When the thermal expansion coefficient greatly differs between the board used for mounting and the chip, it will cause cracking of the chip due to the thermal expansion and contraction.

When capacitors are mounted on a fluorine resin printed circuit board or on a single-layered glass epoxy board, it may also cause cracking of the chip for the same reason.

<Applicable to NFM Series>

1-3. Because noise is suppressed by shunting unwanted high-frequency components to the ground, when designing a land for the NFM series, design the ground pattern to be as large as possible in order to better bring out this characteristic. As shown in the figure below, noise countermeasures can be made more effective by using a via to connect the ground pattern on the chip mounting surface to a larger ground pattern on the inner layer.

Continued on the following page. ↗

Notice

Continued from the preceding page. ↘

Pattern Forms

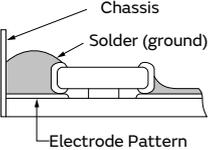
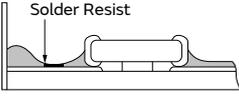
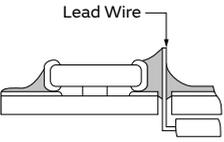
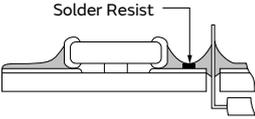
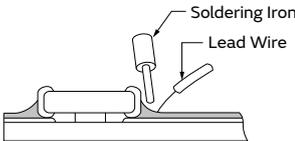
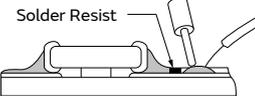
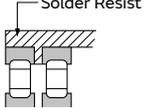
	Prohibited	Correct
Placing Close to Chassis	 <p style="text-align: right;">in section</p>	 <p style="text-align: right;">in section</p>
Placing of Chip Components and Leaded Components	 <p style="text-align: right;">in section</p>	 <p style="text-align: right;">in section</p>
Placing of Leaded Components after Chip Component	 <p style="text-align: right;">in section</p>	 <p style="text-align: right;">in section</p>
Lateral Mounting		

2. Land Dimensions

2-1. Please refer to the land dimensions in table 1 for flow soldering, table 2 for reflow soldering, table 3 for reflow soldering for ZRB Series, table 4 for reflow soldering for LLA Series, table 5 for reflow soldering for LLM Series.

Please confirm the suitable land dimension by evaluating of the actual SET / PCB.

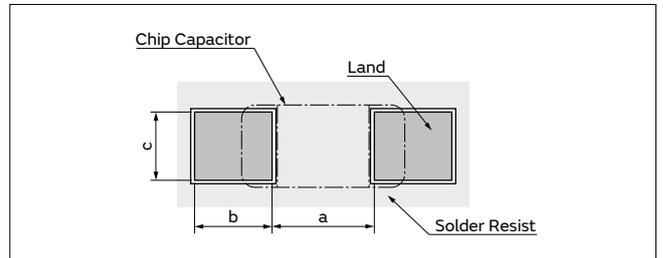

Table 1 Flow Soldering Method

Series	Chip Dimension Code (L/W)	Chip (L×W)	a	b	c
GQM/GR3/GRJ/GRM	18	1.6×0.8	0.6 to 1.0	0.8 to 0.9	0.6 to 0.8
GQM/GR3/GRJ/GRM	21	2.0×1.25	1.0 to 1.2	0.9 to 1.0	0.8 to 1.1
GR3/GRJ/GRM	31	3.2×1.6	2.2 to 2.6	1.0 to 1.1	1.0 to 1.4
LLL	21	1.25×2.0	0.4 to 0.7	0.5 to 0.7	1.4 to 1.8
LLL	31	1.6×3.2	0.6 to 1.0	0.8 to 0.9	2.6 to 2.8

Flow soldering can only be used for products with a chip size from 1.6x0.8mm to 3.2x1.6mm.

(in mm)

Continued on the following page. ↗

Notice

Continued from the preceding page. ↘

Table 2 Reflow Soldering Method

Series	Chip Dimension Code (L/W)	Chip (L×W)	a	b	c
GJM/GRM	02	0.4×0.2	0.16 to 0.2	0.12 to 0.18	0.2 to 0.23
GJM/GRM	03	0.6×0.3 (±0.03)	0.2 to 0.25	0.2 to 0.3	0.25 to 0.35
		0.6×0.3 (±0.05)	0.2 to 0.25	0.25 to 0.35	0.3 to 0.4
		0.6×0.3 (±0.09)	0.23 to 0.3	0.25 to 0.35	0.3 to 0.4
GJM/GRM	15	1.0×0.5 (within ±0.10)	0.3 to 0.5	0.35 to 0.45	0.4 to 0.6
		1.0×0.5 (±0.15/±0.20)	0.4 to 0.6	0.4 to 0.5	0.5 to 0.7
GQM/GR3/GRJ/GRM	18	1.6×0.8 (within ±0.10)	0.6 to 0.8	0.6 to 0.7	0.6 to 0.8
		1.6×0.8 (±0.15/±0.20)	0.7 to 0.9	0.7 to 0.8	0.8 to 1.0
GQM	21	2.0×1.25	1.0 to 1.2	0.6 to 0.7	0.8 to 1.1
GR3/GRJ/GRM/GR7	21	2.0×1.25 (within ±0.10)	1.2	0.6	1.25
		2.0×1.25 (±0.15)	1.2	0.6 to 0.8	1.2 to 1.4
		2.0×1.25 (±0.20)	1.0 to 1.4	0.6 to 0.8	1.2 to 1.4
GQM	22	2.8×2.8	2.2 to 2.5	0.8 to 1.0	1.9 to 2.3
GR3/GRJ/GRM/GR7	31	3.2×1.6 (within ±0.20)	1.8 to 2.0	0.9 to 1.2	1.5 to 1.7
		3.2×1.6 (±0.30)	1.9 to 2.1	1.0 to 1.3	1.7 to 1.9
GR3/GRJ/GRM	32	3.2×2.5	2.0 to 2.4	1.0 to 1.2	1.8 to 2.3
GA2/GA3/GR4	42	4.5×2.0	2.8 to 3.4	1.2 to 1.4	1.4 to 1.8
GR3/GRJ/GRM/GA2/GA3/GR4	43	4.5×3.2	3.0 to 3.5	1.2 to 1.4	2.3 to 3.0
GA2/GA3	52	5.7×2.8	4.0 to 4.6	1.4 to 1.6	2.1 to 2.6
GR3/GRJ/GRM/GA2/GA3/GR4	55	5.7×5.0	4.0 to 4.6	1.4 to 1.6	3.5 to 4.8
LLL	15	0.5×1.0	0.15 to 0.2	0.2 to 0.25	0.7 to 1.0
LLL	1U	0.6×1.0	0.20 to 0.25	0.25 to 0.35	0.7 to 1.0
LLL/LLR	18	0.8×1.6	0.2 to 0.3	0.3 to 0.4	1.4 to 1.6
LLL	21	1.25×2.0	0.4 to 0.5	0.4 to 0.5	1.4 to 1.8
LLL	31	1.6×3.2	0.6 to 0.8	0.6 to 0.7	2.6 to 2.8

(in mm)

<Applicable to Part Number KR3/KRM>

Series	Chip Dimension Code (L/W)	Chip (L×W)	a	b	c
KRM	21	2.0×1.25	1.0 to 1.2	0.6 to 0.7	0.8 to 1.1
KRM	31	3.2×1.6	2.2 to 2.4	0.8 to 0.9	1.0 to 1.4
KR3/KRM	55	5.7×5.0	2.6	2.7	5.6

(in mm)

Table 3 ZRB Series Reflow Soldering Method

Series	Chip Dimension Code (L/W)	Chip (L×W)	a	b	c
ZRB	15	1.0×0.5	0.4 to 0.6	0.4 to 0.5	0.5 to 0.7
ZRB	18*	1.6×0.8	0.7 to 0.9	0.7 to 0.8	0.8 to 1.0

*If distance between parts is too short, there is risk to cause electrical short. Please confirm the mounting pitch (distance between centers of parts) has 1.275mm or more. (ZRB18 only)

[Land for ZRB Series]

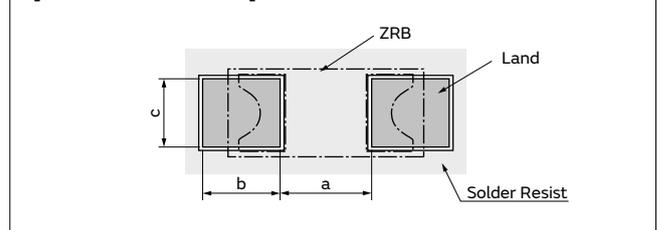

Table 4 LLA Series Reflow Soldering Method

Series	Chip Dimension Code (L/W)	Chip (L×W)	a	b	c	p
LLA	18	1.6×0.8	0.3 to 0.4	0.25 to 0.35	0.15 to 0.25	0.4
LLA	21	2.0×1.25	0.5 to 0.7	0.35 to 0.6	0.2 to 0.3	0.5

(in mm)

Continued on the following page. ↗

Notice

Continued from the preceding page. ↘

Table 5 LLM Series Reflow Soldering Method

Series	Chip Dimension Code (L/W)	Chip (L×W)	a	b, b'	c, c'	d	e	f	p
LLM	21	2.0×1.25	0.6 to 0.8	(0.3 to 0.5)	0.3	2.0 to 2.6	1.3 to 1.8	1.4 to 1.6	0.5

$b=(c-e)/2, b'=(d-f)/2$ (in mm)

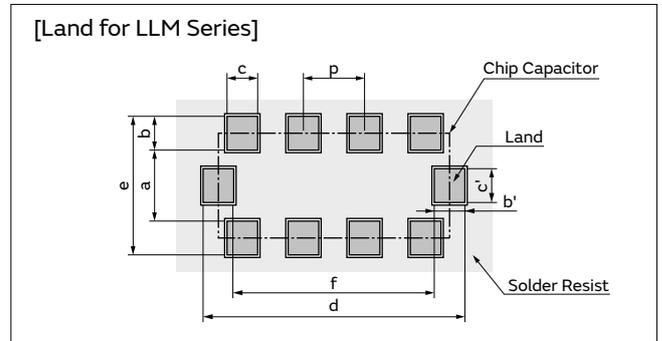
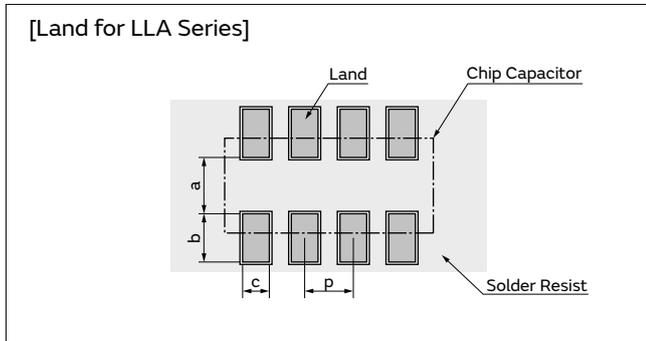

<Applicable to beyond Rated Voltage of 200VDC>

2-2. Dimensions of Slit (Example)

Preparing the slit helps flux cleaning and resin coating on the back of the capacitor.

However, the length of the slit design should be as short as possible to prevent mechanical damage in the capacitor.

A longer slit design might receive more severe mechanical stress from the PCB.

Recommended slit design is shown in the Table.

L×W	d	e
1.6×0.8	-	-
2.0×1.25	-	-
3.2×1.6	1.0 to 2.0	3.2 to 3.7
3.2×2.5	1.0 to 2.0	4.1 to 4.6
4.5×2.0	1.0 to 2.8	3.6 to 4.1
4.5×3.2	1.0 to 2.8	4.8 to 5.3
5.7×2.8	1.0 to 4.0	4.4 to 4.9
5.7×5.0	1.0 to 4.0	6.6 to 7.1

(in mm)

Continued on the following page. ↗

GRM

GR3

GRJ

GR4

GR7

GJM

GQM

GA2

GA3

GB

GA3

GD

GA3

GF

LLL

LLA

LLM

LLR

NFM

KRM

KR3

GMA

GMD

Notice

Notice

Continued from the preceding page. ↘

<Applicable to NFM Series>

■ Land Pattern + Solder Resist ■ Land Pattern □ Solder Resist (in mm)

Series	Land Dimensions																																								
NFM15CC NFM15PC NFM18CC NFM18PC NFM18PS NFM21CC NFM21PC NFM21PS	<p>● Reflow Soldering</p>																																								
	<p>NFM15CC/NFM15PC</p>	<p>NFM18CC/NFM18PC</p> <p>Small diameter thru hole ø0.2-ø0.3</p>	<p>NFM18PS</p> <p>Small diameter thru hole ø0.2</p>																																						
	<p>NFM21CC/NFM21PC</p> <p>Small diameter thru hole ø0.4</p>	<p>NFM21PS</p> <p>Small diameter thru hole ø0.2-ø0.3</p>																																							
	<p>● Reflow Soldering Chip mounting side</p>																																								
	<p>NFM3DCC/NFM3DPC/NFM31PC/NFM41CC/NFM41PC</p> <p>Small diameter thru hole ø0.4</p> <table border="1"> <thead> <tr> <th rowspan="2">Part Number</th> <th colspan="7">Size (mm)</th> </tr> <tr> <th>a</th> <th>b</th> <th>c</th> <th>d</th> <th>e</th> <th>f</th> <th>g</th> </tr> </thead> <tbody> <tr> <td>NFM3DCC NFM3DPC</td> <td>1.0</td> <td>1.4</td> <td>2.5</td> <td>4.4</td> <td>1.0</td> <td>2.0</td> <td>2.4</td> </tr> <tr> <td>NFM31PC</td> <td>1.0</td> <td>1.4</td> <td>2.5</td> <td>4.4</td> <td>1.2</td> <td>2.6</td> <td>3.0</td> </tr> <tr> <td>NFM41CC NFM41PC</td> <td>1.5</td> <td>2.0</td> <td>3.5</td> <td>6.0</td> <td>1.2</td> <td>2.6</td> <td>3.0</td> </tr> </tbody> </table>	Part Number	Size (mm)							a	b	c	d	e	f	g	NFM3DCC NFM3DPC	1.0	1.4	2.5	4.4	1.0	2.0	2.4	NFM31PC	1.0	1.4	2.5	4.4	1.2	2.6	3.0	NFM41CC NFM41PC	1.5	2.0	3.5	6.0	1.2	2.6	3.0	<p>● Flow Soldering Chip mounting side</p>
	Part Number		Size (mm)																																						
a		b	c	d	e	f	g																																		
NFM3DCC NFM3DPC	1.0	1.4	2.5	4.4	1.0	2.0	2.4																																		
NFM31PC	1.0	1.4	2.5	4.4	1.2	2.6	3.0																																		
NFM41CC NFM41PC	1.5	2.0	3.5	6.0	1.2	2.6	3.0																																		
<p>NFM31KC*1</p> <p>10mm or more (in case of 10A)</p> <p>Small diameter thru hole ø0.4</p> <p>*1 For large current design, width of signal land pattern should be wider not less than 1mm per 1A (1mm/A). For example, in case of 10A, signal land pattern width should be 10mm or more. (1mm/A*10A=10mm)</p>	<p>NFM31KC*1</p> <p>10mm or more (in case of 10A)</p> <p>Small diameter thru hole ø0.4</p> <p>*1 For large current design, width of signal land pattern should be wider not less than 1mm per 1A (1mm/A). For example, in case of 10A, signal land pattern width should be 10mm or more. (1mm/A*10A=10mm)</p>																																								

Continued on the following page. ↗

GRM
 GR3
 GRJ
 GR4
 GR7
 GJM
 GQM
 GA2
 GA3 GB
 GA3 GD
 GA3 GF
 LLL
 LLA
 LLM
 LLR
 NFM
 KRM
 KR3
 GMA
 GMD
 Notice

Notice

Continued from the preceding page. ↘

3. Board Design

When designing the board, keep in mind that the amount of strain which occurs will increase depending on the size and material of the board.

[Relationship with amount of strain to the board thickness, length, width, etc.]

$$\epsilon = \frac{3PL}{2Ewh^2} \quad \text{Relationship between load and strain}$$

ϵ : Strain on center of board (μst)
 L : Distance between supporting points (mm)
 w : Board width (mm)
 h : Board thickness (mm)
 E : Elastic modulus of board ($\text{N}/\text{m}^2=\text{Pa}$)
 Y : Deflection (mm)
 P : Load (N)

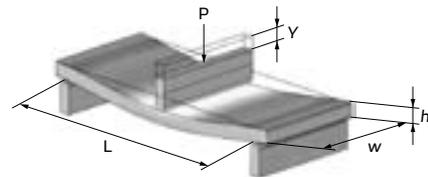

When the load is constant, the following relationship can be established.

- As the distance between the supporting points (L) increases, the amount of strain also increases.
→Reduce the distance between the supporting points.
 - As the elastic modulus (E) decreases, the amount of strain increases.
→Increase the elastic modulus.
 - As the board width (w) decreases, the amount of strain increases.
→Increase the width of the board.
 - As the board thickness (h) decreases, the amount of strain increases.
→Increase the thickness of the board.
- Since the board thickness is squared, the effect on the amount of strain becomes even greater.

2. Adhesive Application

If you want to temporarily attach the capacitor to the board using an adhesive agent before soldering the capacitor, first be sure that the conditions are appropriate for affixing the capacitor. If the dimensions of the land, the type of adhesive, the amount of coating, the contact surface area, the curing temperature, or other conditions are inappropriate, the characteristics of the capacitor may deteriorate.

1. Selection of Adhesive

1-1. Depending on the type of adhesive, there may be a decrease in insulation resistance. In addition, there is a chance that the capacitor might crack from contractile stress due to the difference in the contraction rate of the capacitor and the adhesive.

1-2. If there is not enough adhesive, the contact surface area is too small, or the curing temperature or curing time are inadequate, the adhesive strength will be insufficient and the capacitor may loosen or become disconnected during transportation or soldering.

If there is too much adhesive, for example if it overflows onto the land, the result could be soldering defects, loss of electrical connection, insufficient curing, or slippage after the capacitor is mounted.

Furthermore, if the curing temperature is too high or the curing time is too long, not only will the adhesive

strength be reduced, but solderability may also suffer due to the effects of oxidation on the terminations (outer electrodes) of the capacitor and the land surface on the board.

(1) Selection of Adhesive

Epoxy resins are a typical class of adhesive.

To select the proper adhesive, consider the following points.

- 1) There must be enough adhesive strength to prevent the component from loosening or slipping during the mounting process.
- 2) The adhesive strength must not decrease when exposed to moisture during soldering.
- 3) The adhesive must have good coatability and shape retention properties.
- 4) The adhesive must have a long pot life.
- 5) The curing time must be short.
- 6) The adhesive must not be corrosive to the exterior of the capacitor or the board.
- 7) The adhesive must have good insulation properties.
- 8) The adhesive must not emit toxic gases or otherwise be harmful to health.
- 9) The adhesive must be free of halogenated compounds.

Continued on the following page. ↗

GRM

GR3

GRJ

GR4

GR7

GJM

GQM

GA2

GA3
GB

GA3
GD

GA3
GF

LLL

LLA

LLM

LLR

NFM

KRM

KR3

GMA

GMD

Notice

Notice

Continued from the preceding page. ↘

(2) Use the following illustration as a guide to the amount of adhesive to apply.

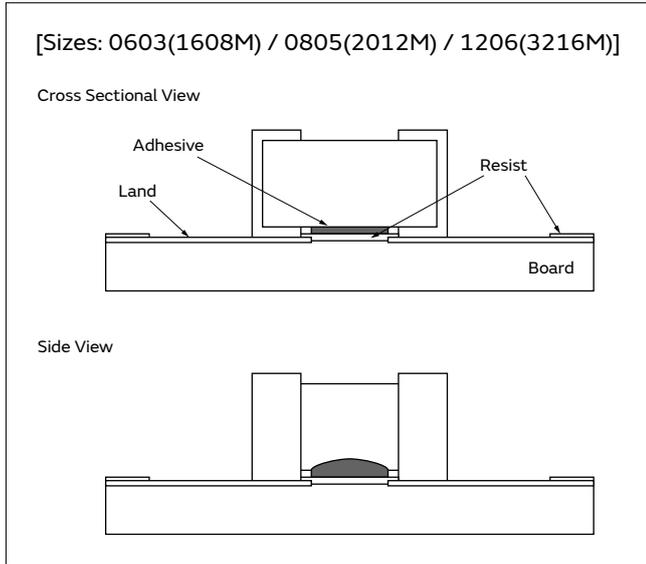

<Applicable to NFM Series>

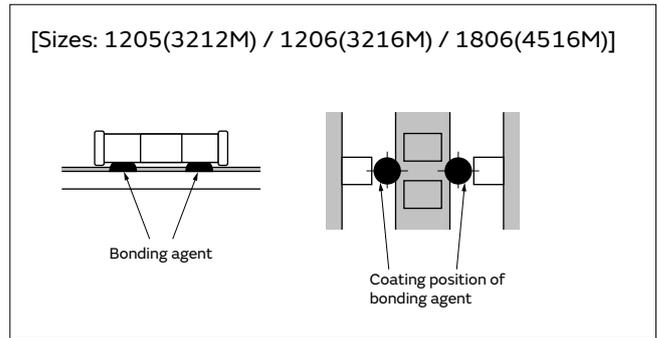

3. Adhesive Curing

1. Insufficient curing of the adhesive can cause chips to disconnect during flow soldering and causes deterioration in the insulation resistance between the terminations due to moisture absorption.

Control curing temperature and time in order to prevent insufficient hardening.

4. Flux for Flow Soldering

1. An excessive amount of flux generates a large quantity of flux gas, which can cause a deterioration of solderability, so apply flux thinly and evenly throughout. (A foaming system is generally used for flow soldering.)

2. Flux containing too high a percentage of halide may cause corrosion of the terminations unless there is sufficient cleaning. Use flux with a halide content of 0.1% max.
 3. Strong acidic flux can corrode the capacitor and degrade its performance.
 Please check the quality of capacitor after mounting.

5. Flow Soldering

● Set temperature and time to ensure that leaching of the terminations does not exceed 25% of the chip end area as a single chip (full length of the edge A-B-C-D shown at right) and 25% of the length A-B shown as mounted on substrate.

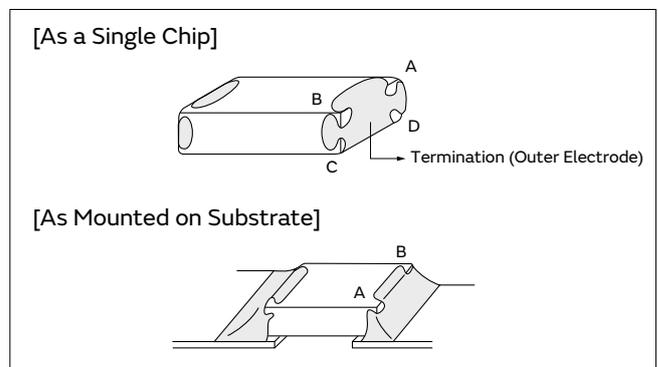

6. Reflow Soldering

The flux in the solder paste contains halogen-based substances and organic acids as activators. Strong acidic flux can corrode the capacitor and degrade its performance.

Please check the quality after mounting, please use.

Continued on the following page. ↗

Notice

Continued from the preceding page. ↘

7. Washing

1. Please evaluate the capacitor using actual cleaning equipment and conditions to confirm the quality, and select the solvent for cleaning.

2. Unsuitable cleaning may leave residual flux or other foreign substances, causing deterioration of electrical characteristics and the reliability of the capacitors.

8. Coating

1. A crack may be caused in the capacitor due to the stress of the thermal contraction of the resin during curing process.
The stress is affected by the amount of resin and curing contraction.
Select a resin with low curing contraction.
The difference in the thermal expansion coefficient between a coating resin or a molding resin and the capacitor may cause the destruction and deterioration of the capacitor such as a crack or peeling, and lead to the deterioration of insulation resistance or dielectric breakdown.
Select a resin for which the thermal expansion coefficient is as close to that of the capacitor as possible.
A silicone resin can be used as an under-coating to buffer against the stress.

2. Select a resin that is less hygroscopic.
Using hygroscopic resins under high humidity conditions may cause the deterioration of the insulation resistance of a capacitor.
An epoxy resin can be used as a less hygroscopic resin.
3. The halogen system substance and organic acid are included in coating material, and a chip corrodes by the kind of Coating material.
Do not use strong acid type.

<Applicable to ZRB Series>

4. Loss suppress acoustic noise may be caused in ZRB series due to the resin during curing process. Please contact our sales representative or product engineers on the apply to resin during curing process.

Other

1. Transportation

1. The performance of a capacitor may be affected by the conditions during transportation.
 - 1-1. The capacitors shall be protected against excessive temperature, humidity, and mechanical force during transportation.
 - (1) Climatic condition
 - low air temperature: -40°C
 - change of temperature air/air: -25°C/+25°C
 - low air pressure: 30 kPa
 - change of air pressure: 6 kPa/min.
 - (2) Mechanical condition
Transportation shall be done in such a way that the boxes are not deformed and forces are not directly passed on to the inner packaging.
 - 1-2. Do not apply excessive vibration, shock, or pressure to the capacitor.
 - (1) When excessive mechanical shock or pressure is applied to a capacitor, chipping or cracking may occur in the ceramic body of the capacitor.
 - (2) When the sharp edge of an air driver, a soldering iron, tweezers, a chassis, etc. impacts strongly on the surface of the capacitor, the capacitor may crack and short-circuit.
 - 1-3. Do not use a capacitor to which excessive shock was applied by dropping, etc.
A capacitor dropped accidentally during processing may be damaged.

2. Characteristics Evaluation in the Actual System

1. Evaluate the capacitor in the actual system, to confirm that there is no problem with the performance and specification values in a finished product before using.
2. Since a voltage dependency and temperature dependency exists in the capacitance of high dielectric type ceramic capacitors, the capacitance may change depending on the operating conditions in the actual system. Therefore, be sure to evaluate the various characteristics, such as the leakage current and noise absorptivity, which will affect the capacitance value of the capacitor.
3. In addition, voltages exceeding the predetermined surge may be applied to the capacitor by the inductance in the actual system. Evaluate the surge resistance in the actual system as required.

<Applicable to NFM Series>

4. The effects of noise suppression can vary depending on the usage conditions, including differences in the circuit or IC to be used, the type of noise, the shape of the pattern to be mounted, and the mounting location. Be sure to verify the effect on the actual device in advance.

GRM

GR3

GRJ

GR4

GR7

GJM

GQM

GA2

GA3
GB

GA3
GD

GA3
GF

LLL

LLA

LLM

LLR

NFM

KRM

KR3

GMA

GMD

Notice

Mouser Electronics

Authorized Distributor

Click to View Pricing, Inventory, Delivery & Lifecycle Information:

Murata:

[GRM0335C1E3R3CD1D](#) [GRM0335C1H100JD01D](#) [GRM0335C1H101JD01D](#) [GRM0335C1H120JD01D](#)
[GRM0335C1H150JD01D](#) [GRM0335C1H180JD01D](#) [GRM0335C1H1R0CD01D](#) [GRM0335C1H1R2CD01D](#)
[GRM0335C1H1R5CD01D](#) [GRM0335C1H1R8CD01D](#) [GRM0335C1H220JD01D](#) [GRM0335C1H270JD01D](#)
[GRM0335C1H2R0CD01D](#) [GRM0335C1H2R2CD01D](#) [GRM0335C1H2R7CD01D](#) [GRM0335C1H330JD01D](#)
[GRM0335C1H390JD01D](#) [GRM0335C1H3R0CD01D](#) [GRM0335C1H3R3CD01D](#) [GRM0335C1H3R9CD01D](#)
[GRM0335C1H470JD01D](#) [GRM0335C1H4R0CD01D](#) [GRM0335C1H4R7CD01D](#) [GRM0335C1H560JD01D](#)
[GRM0335C1H5R0CD01D](#) [GRM0335C1H5R6DD01D](#) [GRM0335C1H680JD01D](#) [GRM0335C1H6R0DD01D](#)
[GRM0335C1H6R8DD01D](#) [GRM0335C1H7R0DD01D](#) [GRM0335C1H820JD01D](#) [GRM0335C1H8R0DD01D](#)
[GRM0335C1H8R2DD01D](#) [GRM0335C1H9R0DD01D](#) [GRM033R61A104KE15D](#) [GRM155R60J474KE01D](#)
[GRM155R60J684KE01D](#) [GRM155R61A684KE15D](#) [GRM155R71A683KA01D](#) [GRM2195C2A152GA01D](#)
[GRM155R71C393KA01D](#) [GRM219R60J106ME19D](#) [GRM32DR60J336ME19L](#) [GRM1555C1HR20BZ01D](#)
[GRM31CR71E335KA88L](#) [GRM1885C2A820JA01D](#) [GRM32ER71A226ME20L](#) [GRM155C80J105KE15D](#)
[GRM2165C1H222GA01D](#) [GRM319R72A104KA01D](#) [GRM188R72A472KA01D](#) [GRM1555C1H151JA01J](#)
[GRM1555C1H102JA01J](#) [GRM155R71H103KA88J](#) [GRM18-KIT-E](#) [GRM1885C2A201JA01D](#) [GRM188R71E105KA12D](#)
[GRM43DR61E106KA12K](#) [GRM3195C2A821JA01D](#) [GRM0335C1E100JD01J](#) [GRM0335C1E101JD01J](#)
[GRM0335C1E150JD01J](#) [GRM0335C1E180JD01J](#) [GRM0335C1E1R8CD01J](#) [GRM0335C1E220JD01J](#)
[GRM0335C1E270JD01J](#) [GRM0335C1E2R2CD01J](#) [GRM0335C1E2R7CD01J](#) [GRM0335C1E330JD01J](#)
[GRM0335C1E3R0CD01J](#) [GRM0335C1E3R3CD01J](#) [GRM0335C1E470JD01J](#) [GRM0335C1E4R0CD01J](#)
[GRM0335C1E4R7CD01J](#) [GRM0335C1E560JD01J](#) [GRM0335C1E5R0CD01J](#) [GRM0335C1E680JD01J](#)
[GRM0335C1E7R0DD01J](#) [GRM0335C1E820JD01J](#) [GRM033C80J223KE01D](#) [GRM033C80J333KE01D](#)
[GRM033R60J104KE19J](#) [GRM033R60J104ME19J](#) [GRM033R61A103KA01J](#) [GRM033R70J103KA01J](#)
[GRM033R70J332KA01D](#) [GRM033R71C222KA88J](#) [GRM1555C1H100JZ01J](#) [GRM1555C1H101JZ01J](#)
[GRM1555C1H120JZ01J](#) [GRM1555C1H121JA01J](#) [GRM1555C1H150JZ01J](#) [GRM1555C1H181JA01J](#)
[GRM1555C1H1R0BZ01J](#) [GRM1555C1H1R0CZ01J](#) [GRM1555C1H1R2BZ01J](#) [GRM1555C1H1R2CZ01J](#)
[GRM1555C1H1R5BZ01J](#) [GRM1555C1H1R5CZ01J](#) [GRM1555C1H1R8BZ01J](#)