

Programmable Terminals NT11/NT21

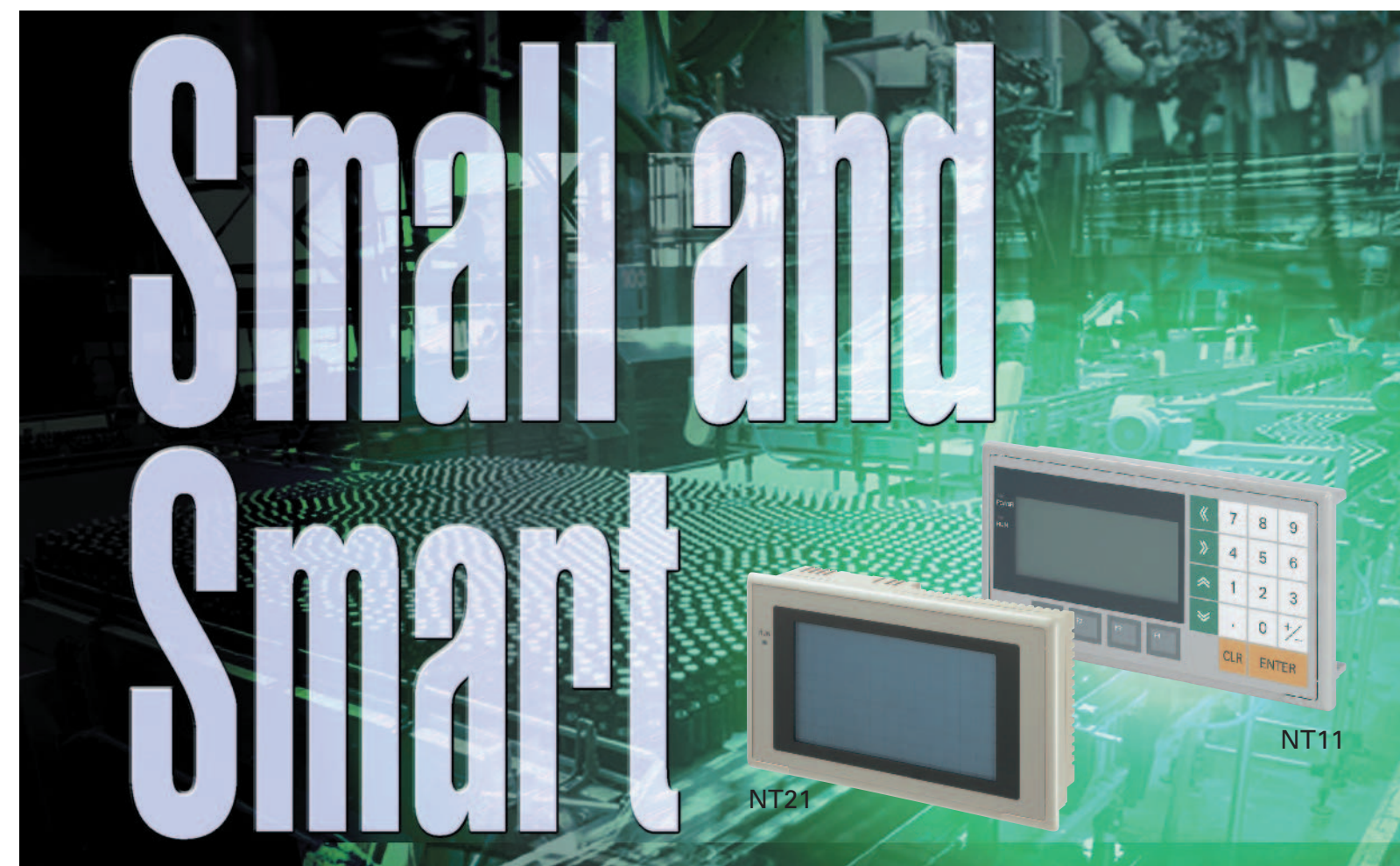
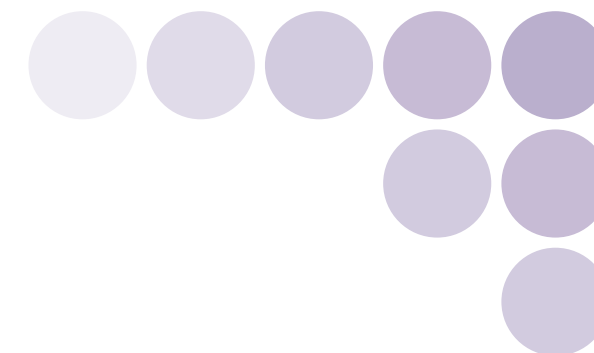

Warranty and Limitations of Liability

WARRANTY
OMRON's exclusive warranty is that the products are free from defects in materials and workmanship for a period of one year (or other period if specified) from date of sale by OMRON.

OMRON MAKES NO WARRANTY OR REPRESENTATION, EXPRESS OR IMPLIED, REGARDING NON-INFRINGEMENT, MERCHANTABILITY, OR FITNESS FOR PARTICULAR PURPOSE OF THE PRODUCTS. ANY BUYER OR USER ACKNOWLEDGES THAT THE BUYER OR USER ALONE HAS DETERMINED THAT THE PRODUCTS WILL SUITABLY MEET THE REQUIREMENTS OF THEIR INTENDED USE. OMRON DISCLAIMS ALL OTHER WARRANTIES, EXPRESS OR IMPLIED.

LIMITATIONS OF LIABILITY
OMRON SHALL NOT BE RESPONSIBLE FOR SPECIAL, INDIRECT, OR CONSEQUENTIAL DAMAGES, LOSS OF PROFITS, OR COMMERCIAL LOSS IN ANY WAY CONNECTED WITH THE PRODUCTS, WHETHER SUCH CLAIM IS BASED ON CONTRACT, WARRANTY, NEGLIGENCE, OR STRICT LIABILITY.

In no event shall the responsibility of OMRON for any act exceed the individual price of the product on which liability is asserted.

IN NO EVENT SHALL OMRON BE RESPONSIBLE FOR WARRANTY, REPAIR, OR OTHER CLAIMS REGARDING THE PRODUCTS UNLESS OMRON'S ANALYSIS CONFIRMS THAT THE PRODUCTS WERE PROPERLY HANDLED, STORED, INSTALLED, AND MAINTAINED AND NOT SUBJECT TO CONTAMINATION, ABUSE, MISUSE, OR INAPPROPRIATE MODIFICATION OR REPAIR.

This catalog mainly provides information that is necessary for selecting suitable models, and does not contain precautions for correct use. Always read the precautions and other required information provided in product operation manuals before using the product.

- The application examples provided in this catalog are for reference only. Check functions and safety of the equipment before use.
- Never use the products for any application requiring special safety requirements, such as nuclear energy control systems, railroad systems, aviation systems, medical equipment, amusement machines, vehicles, safety equipment, or other application involving serious risk to life or property, without ensuring that the system as a whole has been designed to address the risks, and that the OMRON products are properly rated and installed for the intended use within the overall equipment or system.

Note: Do not use this document to operate the Unit.

<p>OMRON Corporation FA Systems Division H.O. 66 Matsumoto Mishima-city, Shizuoka 411-8511 Japan Tel: (81)55-977-9181 Fax: (81)55-977-9045</p>	<p>Regional Headquarters</p> <p>OMRON EUROPE B.V. Wegalaan 67-69, NL-2132 JD Hoofddorp The Netherlands Tel: (31)2356-81-300/Fax: (31)2356-81-388</p> <p>OMRON ELECTRONICS LLC 1 East Commerce Drive, Schaumburg, IL 60173 U.S.A. Tel: (1)847-843-7900/Fax: (1)847-843-8568</p> <p>OMRON ASIA PACIFIC PTE. LTD. 83 Clemenceau Avenue, #11-01, UE Square, Singapore 239920 Tel: (65)6835-3011/Fax: (65)6835-2711</p>	<p>Authorized Distributor:</p> <div style="border: 1px solid black; height: 100px; width: 100%;"></div>
---	--	---

Note: Specifications subject to change without notice. Cat. No. V071-E1-02 Printed in Japan 1003-0.5M

**Innovation
in the Solution Age**
OMRON INDUSTRIAL AUTOMATION



Small and Smart

Compact Size, High Performance

Superb functionality with a compact screen size

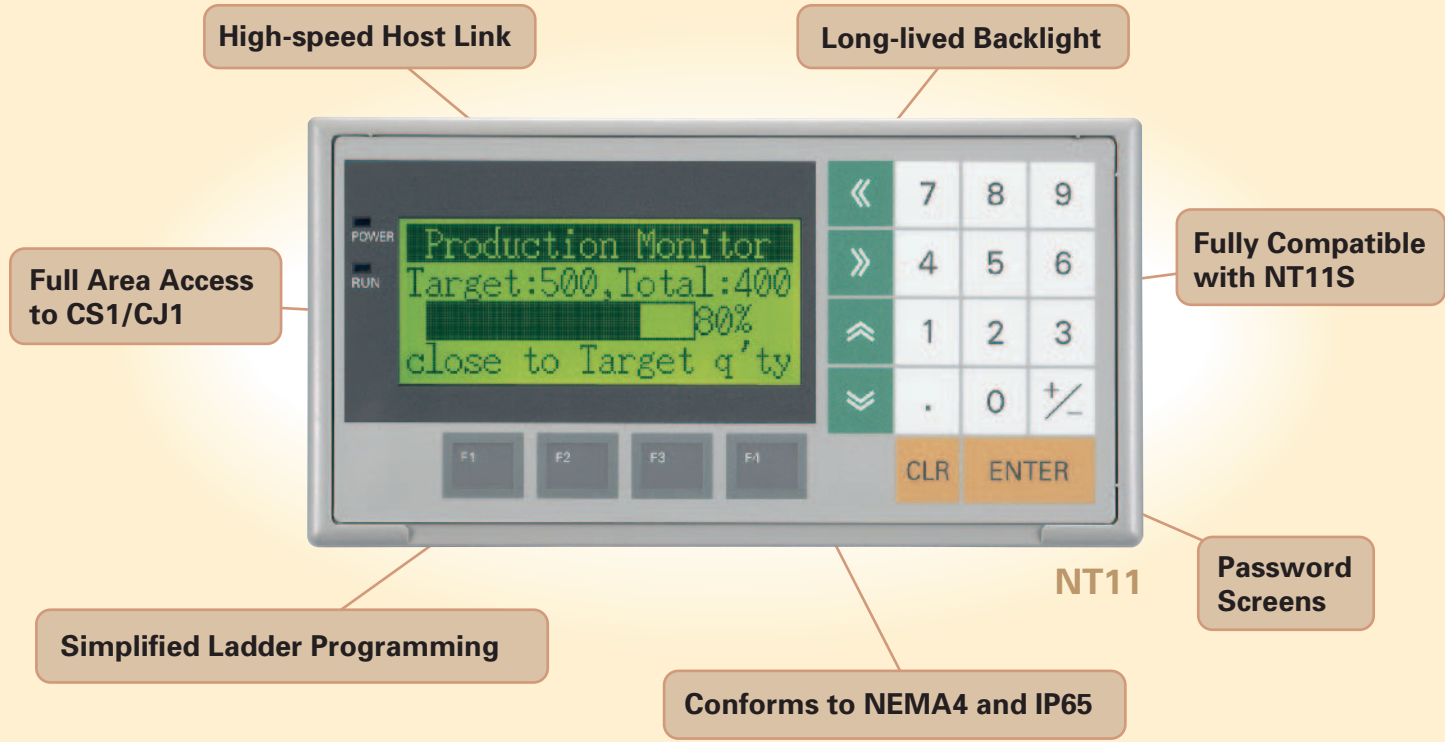
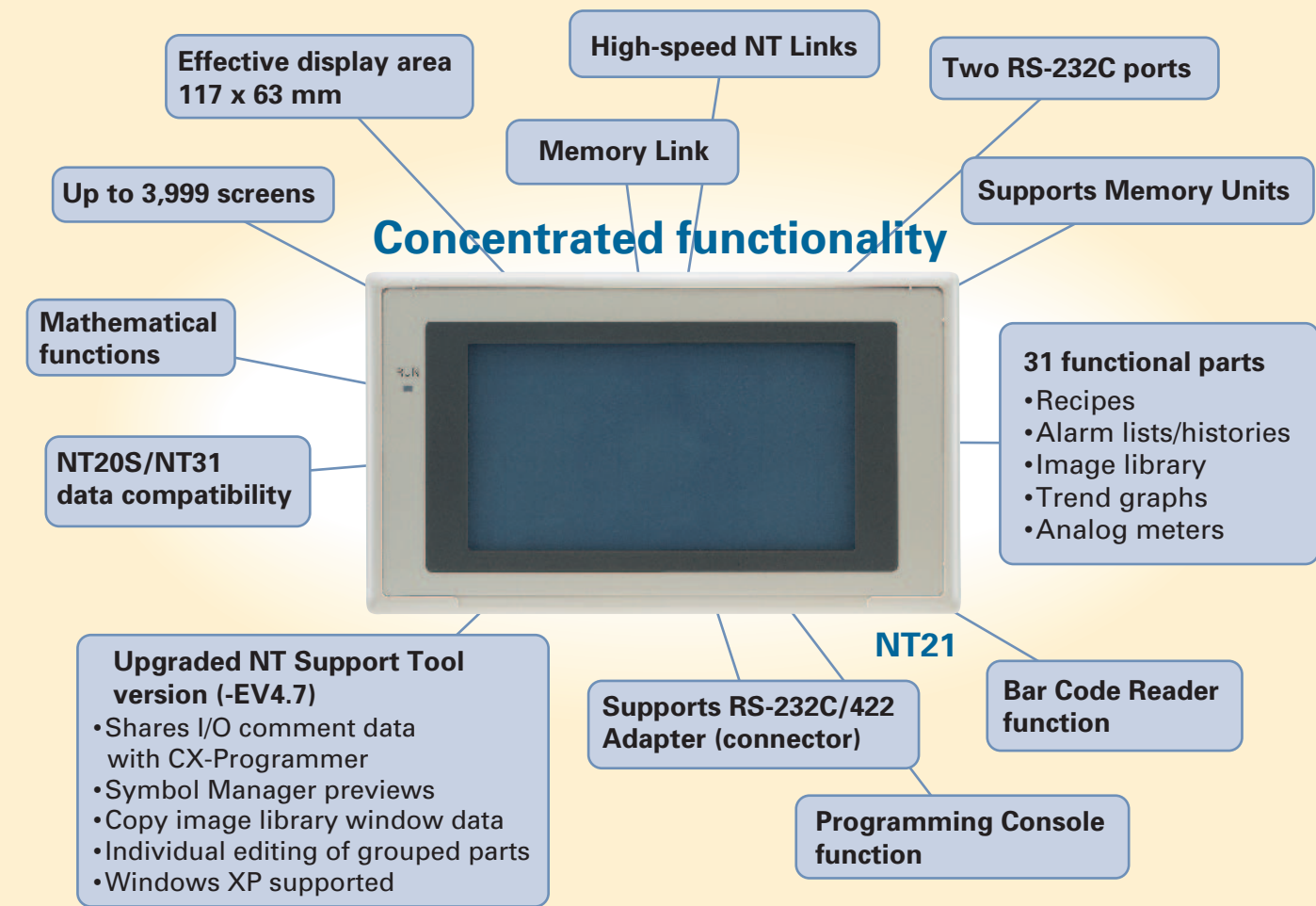

NT11

Printout of Production Status

Data such as the production status and production results can be printed out, leaving a record on paper which can be used as a daily report.
(The NT11S has a printer port. One screen only is printed.)

Screen	Plan	Prod.
Line 1	200	200
Line 2	150	140
Line 3	350	350

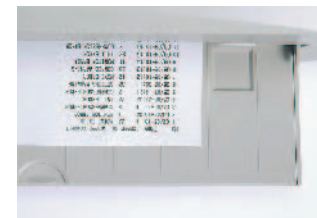

Bar Graphs can be Displayed

Bar graph displays allow the progress of processes to be checked at a glance.
(The bars are oriented horizontally.)

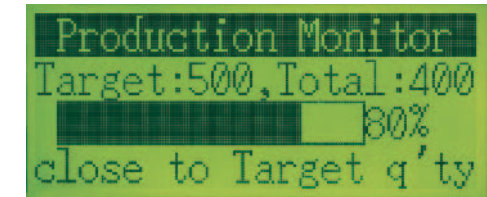

Advantages From the Standpoint of Maintenance,

Password Screens for Security

Password screens cannot be accessed unless the correct password is entered. This means that the operations that can be performed can be restricted according to the operator.



Integral Numeric Key Pad

The display, numeric keys, and function keys are all integrated into the front panel, which is convenient for designers. The key layout is ergonomically designed for ease of use.

High-speed Host Link

Up to 115,200 bps supported between CS1/CJ1 PLCs.

Key Titles can be Marked on the Function Key Sheet

Key titles can be marked on the function key sheet in accordance with the applications of the keys: the sheet can be taken out from the side face of the terminal. The front panel of the terminal has a water-withstanding construction.

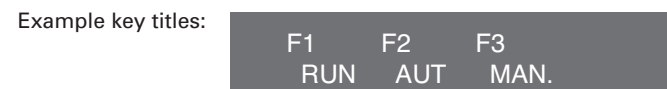

Long-lived Backlight

Since LEDs are used for the backlight, it is very long-lived and rarely needs to be changed.

Display History Record Helps in Analysis of Machine Faults

When the display history record function is set as a screen attribute, the time, the screen number, and a comment are recorded in the terminal's memory every time the relevant screen is displayed. This display history can be printed by issuing a print instruction from the host, and is useful for machine fault analysis.

Example printout

No.	Time	Screen No	Screen Comment
1	11/01-10:00	1	LINE ERROR
2	11/07-15:33	15	MOTOR ERROR
3	11/11-13:56	19	COMPRESSER ERROR
4	11/14-09:12	5	MOTOR ERROR

Versatile I/O and Large-capacity Screen Memory in a Space-saving Size

Small Size, Large Screen

The LCD screen is larger than the OMRON NT20S (increased from 256 x 128 dots to 260 x 140 dots), but the external dimensions and panel cut-out size are the same.



Two RS-232C Ports

Two RS-232C ports in the NT21 (compared with one in the NT20S) enable simultaneous connection of a PLC, Bar Code Reader, and NT Support Tool (connectable to serial port A only).

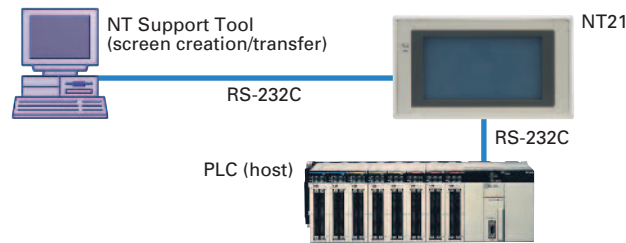

Plenty of Capacity for Saving Graphic Screens

With 512 Kbytes of memory capacity, there is more than ample space for storing screen data.

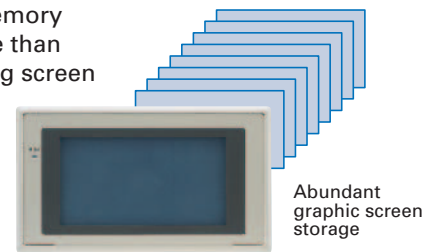

Versatile Communications

In addition to the Host Link and 1:1 NT Link communications, the NT21 supports high-speed 1:N NT Links and Memory Link communications.

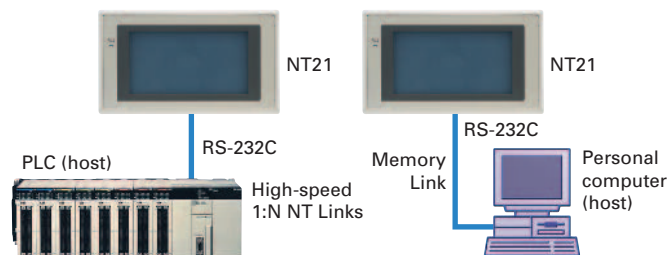

Highly Reliable Hardware

Long, Maintenance-Free Life (50,000 h)

Conforms to International Standards

The NT21 conforms to the EC Directives, as well as UL, cULus (Class 1 Div2), and C-Tick. The front panel has an enclosure rating equivalent to IP65F.

System and screen data can be stored in NT21 Flash Memory.

Function Support Equivalent to That of a Mid-size Operator Interface

Recipe Function

Parts tables on the PT screen can be used to set multiple word data in records, which can then be written to the PLC by a simple PT touch panel operation. For example, the setting parameters for separate models can be edited on the PT, then written to or read from the PLC.

No.	Cake	Cream	Sugar	Egg
1	Cheese	1000	300	20
2	Almond	300	200	10
3	Pound	1000	200	10
4	Carrot	800	150	10
5	Apple	500	300	5
Write		Read		

Alarm List/History(*)

An alarm message can be displayed in response to PLC bit status, and the content and time of the message can be stored as an alarm history.

Alarm History	Menu
order of occurrence	Reset
Cur. Time 01/09/17 17:24:26	
Battery Error 01/09/17 14:20	
Sensor Error 01/09/14 16:15	
Feed Error 01/09/12 10:05	
Pump Error 01/09/11 11:48	

*C500-BAT08 Battery (sold separately) required.

Programming Console Function

The NT21 is equipped with many of the same functions as the SYSMAC PLC Programming Console.

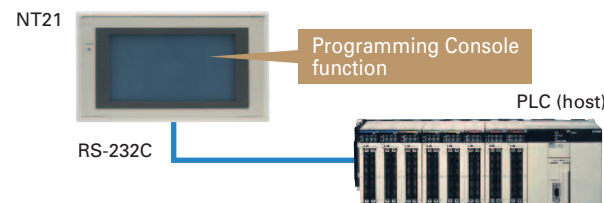

Mathematical Functions

Up to 256 math equations can be stored in the PT processing table to allow automatic PT processing, and the results can be written to the numeral memory table or other destinations. This makes it possible to perform scaling and other mathematical operations automatically in the PT.

Upgraded NT Support Tool Version (-EV4.7)

Enhanced Editing Functions

I/O comments in the I/O tables of the CX-Programmer can be used directly.

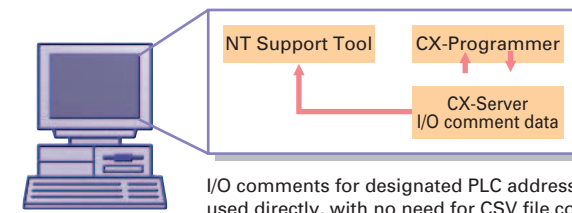

I/O comments for designated PLC addresses can be used directly, with no need for CSV file conversion.

Symbol Manager previews are supported. This function makes it possible to preview symbols (parts created from graphics data).

- Parts can be copied by drag & drop operations of image, library, or mark data.
- The properties of grouped parts can be edited without having to ungroup them.
- Because NT20S and NT31 screen data is compatible with the NT21, existing software assets can be utilized to greatly reduce the number of design steps.

Note: Some data revisions may be required due to size differences.

- Windows XP supported.

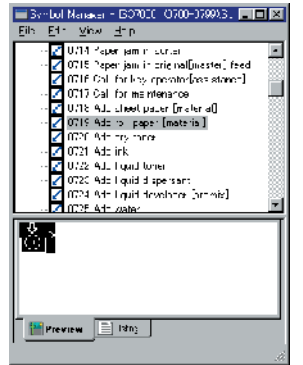

Comparison with the NT11

	Model	NT11	NT11S	NT21	NT20S		
Basic performance	Dimensions	218 x 113 x 38.2 mm (H x W x D)			190 x 110 x 53.5 mm (H x W x D)		
	Resolution	160 x 64 dots (4.24 inches)			260 x 140 dots (5.2 inches)	256 x 128 dots (4.91 inches)	
	Effective display area	100 x 40 mm			117 x 63 mm	112 x 56 mm	
	Display color	Black & white (with Yellow mode)			Black & white (with blue mode)		
	Panel cut-out size (W x H)	204.2 x 99.8 mm			178.5 x 100.5 mm		
	Max. number of registered screens	250			3,999	500	
	Screen data capacity	32 KB			512 KB	96 KB	
	Function keys	4			None	None	
	Other Keys	Numeric Keys, Cursor Keys, Function Keys			None	None	
	Display elements	Rectangles, polygons, arcs, sectors	None			Supported	None
Painting out		None			Supported	None	
Image/library displays		None			256 positions per screen	None	
Analog meters		None			50 positions per screen	None	
Trend graphs		None			1 position per screen	None	
Broken line graphs		None			1 position per screen	None	
Alarm lists/histories		None			4 positions per screen	None	
Recipes		None			1 position per screen	None	
Interlocks		None			Supported	None	
Special functions		Mathematical Function	None			Math equations: Max. 256 (arithmetic functions, logic operations, bit manipulations, comparison operations)	None
	Programming Console function	None			(Executes functions equivalent to C200H-PR027 and CS1 Programming Consoles.)	None	
	High-quality font	None			Supported	None	
	Memory Unit	None (Emergency transfer mode)*			Supported	None	
	Backlight service life	50,000 hours min.	10,000 hours min.		50,000 hours min.	10,000 hours min.	
	Communications	Memory Links	None			Supported	Via RS-232C communications
		Bar Code Reader connection	None			Supported	None
		Host Link Speed	Up to 115,200		9,600/19,200	9,600/19,200	9,600/19,200

*Emergency transfer mode: When power to the NT11 is turned ON with DIP switch pin 3 turned ON, data transfer mode can be entered directly without any other operation.

■NT11 General Specifications

Item	Specification
Power supply voltage	24 VDC
Allowable power supply voltage range	20.4 to 27.6 VDC (24 VDC -15%, +15%)
Power consumption	10 W max.
Noise resistance	Conforms to IEC61000-4-4, 2K (power lines)
Vibration resistance	10 to 57 Hz with 0.075 mm amplitude and 57 to 150 Hz with 9.8 m/s ² acceleration for 30 min in each of X, Y, and Z directions
Shock resistance	147 m/s ² 3 times in each of X, Y, and Z directions
Ambient operating temperature	0 to +50°C
Ambient operating humidity	35 to 85% RH (with no condensation)
Operating environment	No corrosive gasses.
Storage temperature	-20 to +70°C (with no freezing)
Enclosure ratings	Front panel: Equivalent to IP65, NEMA4
Weight	1.0 kg max.

■Display/Panel Specifications

Note: In order to improve the performance of displays, liquid crystal devices may be changed without notice.

Item	Specification
Display screen	<ul style="list-style-type: none"> Dot matrix of STN liquid crystal display panel Number of dots: 160 x 64 Effective display area: 100 x 40 mm Life expectancy: 50,000 hours minimum View angle (left/right direction): ±20°
Indicators	<ul style="list-style-type: none"> POWER indicator (Green LED): Lit while power is being supplied. RUN indicator (Green LED): Lit during operation
Switch	<ul style="list-style-type: none"> 22 switches Life expectancy: 1 million operations minimum

■Display Capacity

Note: In order to improve the performance of displays, liquid crystal devices may be changed without notice.

Item	Specification	
Display characters	Normal characters (8 x 16 dots): Alphanumerics and symbols Marks (8 x 16 dots): User-defined, 64 max.	
Number of characters displayed	Normal-size: 20 horizontally x 4 lines vertically max.	
Enlargement function	Double width	
Display elements	Character string displays	8 positions per screen
	Numeral displays	8 positions per screen
	Graph displays	4 positions per screen
Screen attributes	Numeral settings	8 positions per screen
	Display history	Order of frequency, 256 screens
Screen types	Password screen	Ensures security: screens for which this attribute is set can only be displayed if the correct password is input.
	Menu screen	Four items per screen
Screen types	Normal screen: Displays screen registered as normal.	
Max. number of registered screens	250	
Screen registration method	Transfer screen data created using an IBM PC/AT personal computer to the PT.	
Screen saving method	Saved to flash memory: 32 KB (downloading method)	

■Special Features

Item	Specification
Printing function	<ul style="list-style-type: none"> Printing of display history data Printing of daily reports (printing format registered by the users)
Maintenance functions	<ul style="list-style-type: none"> Self-test for memory, switches, etc. Status setting confirmation for communications and other conditions. Simple communications confirmation.

■NT11 Product Configurations

Product	Specification	Model	
Programmable Terminal*	Host link direct connection,	Ten-key type (frame color: beige)	NT11-SF121-EV1
	NT link method	Ten-key type (frame color: black)	NT11-SF121B-EV1
Support Software	CD-ROM (for Windows 95, 98, Me, XP, NT, 2000)	NT-ZJCAT1-EV4	NT-ZJCAT1-EV4
		NT-CKF01	NT-CKF01
Function key sheet	10 sheets for replacement for beige	NT11-CKF01	
	10 sheets for replacement for black	NT11-CKF01B	

*The PT body incorporated the communication interface, screen memory, and a flash ROM that downloads the system program.

*Connecting cables with the PLC and NTST are the same as those for the NT21. Please refer to the next page.

■Outside Dimensions

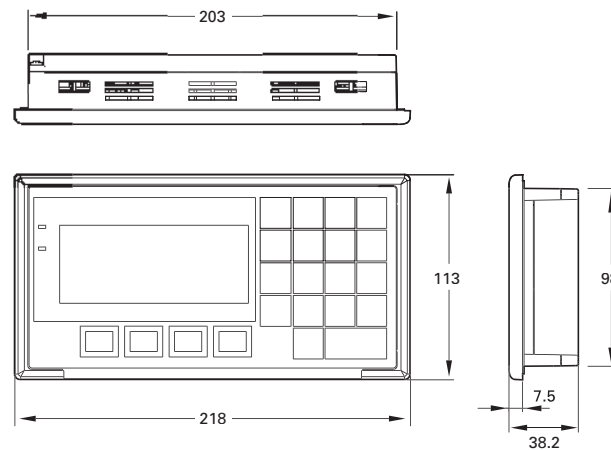

■Panel Plate thickness: 1.6 to 4.8 mm

■Recommended panel cutout:

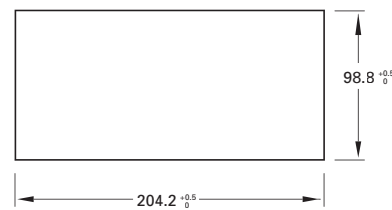

■Rear face

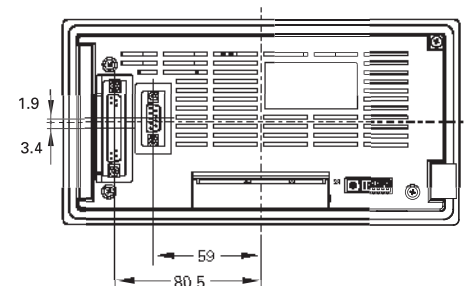

■NT21 General Specifications

Item	Specification
Power supply voltage	24 VDC ±15%
Power consumption	7 W max.
Noise resistance	Conforms to IEC61000-4-4. Power supply line: 2 kV
Vibration resistance	10 to 57 Hz with 0.075-mm single amplitude, 57 to 150 Hz with 9.8 m/s ² acceleration, for a total of 60 min in X, Y, and Z directions
Shock resistance	Peak acceleration 15 G, 3 times each in X, Y, and Z directions
Ambient operating temperature	0 to 50°C (with no icing)
Storage temperature	-20 to +70°C (with no icing)
Ambient operating humidity	35% to 85% (with no condensation)(0 to 40°C) 35% to 55% (with no condensation)(40 to 50°C)
Dimensions	190 x 110 x 53.5 mm (W x H x D) (thickness inside panel: 49.0 mm)
Enclosure ratings	Front panel operating section: Equivalent to IP65F, NEMA 4.*
Weight	0.6 kg max.

*Usage may not be possible in places where the unit would be exposed to oil for long periods.

■Display Capacity

Item	Specification	
Display elements	Fixed displays	A total of 65,535 per screen (Graphics: Continuous straight lines, rectangles, circles, polygons, arcs, sectors)
	Fixed character strings	With overlapping screens, the total is 524,280 per screen
	Graphics	
	Marks	
	Numeral displays	256 positions per screen, max. 10-digit display (2 words)
	Character string displays	256 positions per screen, max. 1,024 display elements for overlapping screens
	Graph displays	50 positions per screen, capable of displaying signs and percentages
	Analog meters	50 positions per screen, capable of displaying signs and percentages
	Trend graphs	One frame per screen, 50 items per frame (8 items max. for data logging)
	Broken line graphs	One frame per screen, 256 items per frame, 260 points per item
Screen types	Lamps	256 positions per screen
	Image library images	256 positions per screen
	Touch switches	256 positions per screen, max. 256 meshes
	Numeral settings	256 positions per screen (numerical key pad)
	Thumbwheel settings	26 positions per screen
	Character string settings	256 positions per screen
	Temporary inputs	One position per screen
	Alarm lists/histories	Four groups per screen
	Recipes	One position per screen
	Normal screens	Displays screens registered as normal
Screen attributes	Overlapping screens	A maximum of eight screens can be displayed overlapping each other.
	Windows	Up to three window screens can be displayed.
	Display history screens	Order of occurrence (1,024 screens max.), order of frequency (255 times max.)
	System startup screen	Displayed when powering ON (or resetting) the PT, and when switching to RUN mode.
	Programming Console screen	Emulates PLC Programming Console functions, capable of being called from RUN mode.
Screen attributes	Buzzer, display history, normal background colors, backlight mode, local windows	
Number of screens	Max. number of registered screens	3,999
	Screen number	<ul style="list-style-type: none"> 0: No display 1 to 3999: User registered screens (normal, overlapping, windows) 9000: System startup screen 9001: Display history screens, order of occurrence 9002: Display history screens, order of frequency 9020: Programming Console screen 9021 to 9023, 9030: Reserved 9999: Return to previous screen designation
Screen registration method	By transferring screen data from the NT Support Tool to the PT via serial communications By mounting the Memory Unit and downloading (automatic/manual transfer) data to the PT	
Saving screen data	Flash memory (PT internal image memory)	

■Display Specifications

Item	Specification	
Display panel	Display device	Monochrome STN LCD
	Number of dots (resolution)	260 dots horizontally x 140 dots vertically
	Effective display area	117 mm horizontally x 63 mm vertically
	Viewing angle	Left/right direction: 30°, up/down: 30°
	Display color	Black & white (with blue mode)
	Service life	50,000 hours min. (until contrast reduced to 50%)
Backlight (white cold cathode tube)	Automatic turn-OFF	Can be set to turn OFF in 1 to 255 min or to remain ON with screen saver
	Service life	50,000 hours min. (at room temperature, until brightness is reduced to 50%)
Replacement	Non-replaceable	

■Panel Specifications

Item	Specification	
Touch panel	Number of switches	91 (13 horizontally x 7 vertically)
	Input	Pressure-sensitive
	Threshold force for operation	1 N max.
	Life expectancy	1 million operations min.

■External Interface Specifications

Communications method	Serial port A	Serial port B
NT Support Tool	Supported	Not supported
PLC	Host Link	Supported
	1:1 NT Link	Supported
	1:N NT Links	Supported
	NT Link, PT Programming Console function	Supported
SBC/personal computer	Memory Links	Supported
Bar Code Reader		Supported

*Connection via RS-422A/485 is possible using the NS-AL002 RS-232C/422A Adapter (connector), which can be connected only to serial port B. (RS-485 connections must use 1:N NT Links.)

■NT21 Standard Models

Product	Specification	Model number	
NT21 Programmable Terminal	Monochrome STN	Frame color: beige NT21-ST121-E	
		Frame color: black NT21-ST121B-E	
Support Tool	Windows 95, 98, Me, NT, or 2000	CD-ROM NT-ZJCAT1-EV4	
Cables	For screen transfer		
		XW2Z-S002	
	For PLC connection	PT: 9-pin PLC: 9-pin	Cable length: 2 m XW2Z-200T
			Cable length: 5 m XW2Z-500T
		PT: 9-pin PLC: 25-pin	Cable length: 2 m XW2Z-200S
			Cable length: 5 m XW2Z-500S
	PT: 9-pin PLC: Mini-peripheral	Cable length: 2 m XW2Z-200T-2	
		Cable length: 5 m XW2Z-500T-2	
Options	Reflection Protective Sheets	Display area only (5 sheets) NT20M-KBA04	
	Chemical-resistive Cover	Silicon cover NT20S-KBA01	
	Battery	For alarm lists/histories C500-BAT08	
	Memory Unit	For screen and system data transfer NT-MF161	
	RS-232C/422A Adapter	NS-AL002	
Connector Kit	XM2S-0911-S003		

■Dimensions

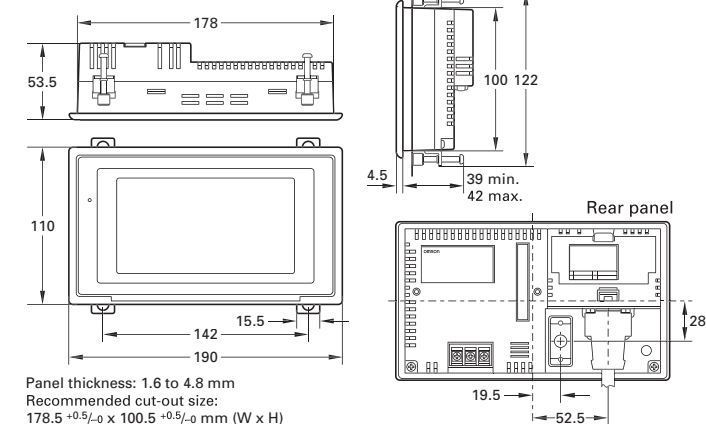

Mouser Electronics

Authorized Distributor

Click to View Pricing, Inventory, Delivery & Lifecycle Information:

Omron:

[NT21-ST121-E](#) [NT21-ST121B-E](#)