



MAX11040K Evaluation Kit/Daughterboard

General Description

The MAX11040K evaluation kit (EV kit) is a fully assembled and tested PCB that evaluates the IC's 4-channel, simultaneous-sampling ADC. The EV kit also includes Windows® 2000-, Windows XP®, and Windows Vista®-compatible software that provides a simple graphical user interface (GUI) for exercising the IC's features.

The EV kit comes with two MAX11040KGUU+s installed on the motherboard. Up to three more parts can be connected to the EV kit to increase the number of input channels by cascading up to three daughterboards to the EV kit (order separately).

Ordering Information appears at end of data sheet.

Windows, Windows XP, and Windows Vista are registered trademarks of Microsoft Corp.

Features

- ◆ **Eight Simultaneous ADC Channel Inputs (EV Kit Only)**
- ◆ **Up to 20* Simultaneous ADC Channel Inputs with the EV Kit and the Daughterboards**
- ◆ **Four Banana Jacks for Power-Supply Inputs**
- ◆ **BNC Connectors on Channel 0 and Channel 1 for the EV Kit and Daughterboard for the Signal Inputs**
- ◆ **Autofrequency, RMS, Min, Max, and Average DC Calculations in the EV Kit Software**
- ◆ **USB-PC Connection**
- ◆ **Proven PCB Layout**
- ◆ **Windows 2000-, Windows XP-, and Windows Vista (32-Bit)-Compatible Evaluation Software**
- ◆ **Fully Assembled and Tested**

*The EV kit design limits 20 ADC channel inputs; however, the IC supports up to 32 ADC channel inputs when designed in a system using eight ICs.

Evaluate: MAX11040K

Component Lists

MAX11040K EV Kit

DESIGNATION	QTY	DESCRIPTION
AIN0-, AIN0+, AIN1-, AIN1+	4	75Ω, 4-pin BNC female jack receptacles, 0.250in spacing (top mount)
AVDD, AGND, DVDD, DGND	4	Uninsulated banana jacks
C1, C2, C4, C5, C10, C11, C13, C14, C22, C23, C25, C26, C30, C31, C33, C34, C46, C47	18	10pF ±5%, 50V C0G ceramic capacitors (0603) TDK C1608C0G1H100J
C3, C6, C7, C8, C12, C15, C16, C18, C20, C24, C27, C28, C32, C35, C36, C37, C40	17	1μF ±10%, 10V X7R ceramic capacitors (0603) TDK C1608X7R1A105K
C9, C17, C19, C21, C29, C38, C48, C59, C64–C78, C80–C99, C101–C104	47	0.01μF ±10%, 50V C0G ceramic capacitors (0603) TDK C1608C0G1E103K

DESIGNATION	QTY	DESCRIPTION
C39, C50–C55, C60, C62, C63	10	0.1μF ±10%, 16V X7R ceramic capacitors (0603) TDK C1608X7R1C104K
C41	1	22μF ±10%, 6.3V X5R ceramic capacitor (0805) TDK C2012X5R0J226K
C42	1	4.7μF ±10%, 6.3V X5R ceramic capacitor (0603) TDK C1608X5R0J475M
C43, C44, C45, C57, C58, C61, C107, C108, C111–C126	0	Not installed, ceramic capacitors (0603)
C49	1	10μF ±10%, 4V X5R ceramic capacitor (0603) TDK C1608X5R0G106K
C79	1	22μF ±20%, 6.3V X7R ceramic capacitor (1206) TDK C3216X7R0J226M

MAX11040K Evaluation Kit/Daughterboard

Component Lists (continued)

MAX11040K EV Kit

DESIGNATION	QTY	DESCRIPTION
C100	1	10 μ F \pm 10%, 6.3V X5R ceramic capacitor (1206) TDK C3216X5R0J106K
C105, C106	2	18pF \pm 5%, 50V C0G ceramic capacitors (0603) TDK C1608C0G1H180J
D1, D3	2	Yellow LEDs (0603)
D2, D4	2	Red LEDs (0603)
D9	1	6.2V, 500mW zener MELF diode Diodes, Inc. ZMM5234B-7
J1	1	USB type-B right-angle PC-mount receptacle
J2	1	Dual-row, 14-pin header (2 x 7)
J3–J10	8	4-position terminal blocks ED100/4DS
J12	1	Dual-row, right-angle male header (2 x 7)
J13, J14	2	Dual-row, 20-pin headers (2 x 10)
JU1, JU2, JU6, JU15–JU19	8	2-pin headers
JU3, JU20	2	3-pin headers
L1, L2	2	30 Ω SMT ferrite beads (0603)
L3–L6	4	220 Ω SMT ferrite beads (0805) Murata BLM21PG221SN1D
R1, R2, R4–R8, R28, R30, R49	0	Not installed, resistors (0603)
R3, R10, R11, R12	4	330 Ω \pm 5% resistors (0603)
R9	1	0 Ω \pm 5% resistor (0603)
R26, R27, R36, R37, R38	5	10k Ω \pm 5% resistors (0603)
R29, R31, R32, R33, R50, R51	6	33 Ω \pm 5% resistors (0603)
R34	1	10 Ω \pm 5% resistor (0603)
R41, R42	2	27 Ω \pm 5% resistors (0603)
R43, R54, R55	3	1.5k Ω \pm 1% resistors (0603)
R44	1	300k Ω \pm 5% resistor (0603)
R45	1	680k Ω \pm 5% resistor (0603)
R46, R47, R48	3	1M Ω \pm 1% resistors (0603)
R53	1	2.2k Ω \pm 5% resistor (0603)

DESIGNATION	QTY	DESCRIPTION
R56	1	100k Ω \pm 5% resistor (0603)
RN1–RN5	5	33 Ω , 8-pin/4-resistor SMT resistor networks Panasonic EXB-28V330JX
RN6	1	10k Ω , 16-pin/8-resistor SMT resistor network Panasonic EXB-2HV103JV
RN7–RN11	5	33 Ω , 16-pin/8-resistor SMT resistor networks Panasonic EXB-2HV330JV
RN12	1	2.2k Ω , 16-pin/8-resistor SMT resistor network Panasonic EXB-2HV222JV
RN13	1	1k Ω , 8-pin/4-resistor SMT resistor network Panasonic EXB-28V102JX
S1	1	4-position, SMT half-pitch DIP switch
S2	1	Pushbutton switch
U1, U2	2	4-channel ADC (38 TSSOP) Maxim MAX11040KGUU+
U3	1	D-flip flop
U7	1	LDO regulator (8 TDFN) Maxim MAX1976AETA160+
U8	1	Controller
U9	1	256kword flash memory (48 TSOP)
U10	1	64Mb SDRAM (54 TSOP) Micron Technology MT48LC4M16A2P-75
U12, U13	2	2-input positive-OR gates (SOT32)
U14	0	Not installed (8 SO)
Y1	1	24.576MHz crystal, 18pF load
Y2	1	12MHz SMT crystal (6mm)
Y3	1	32.768kHz watch crystal, 12.5pF cylindrical
Y4	0	Not installed, 24.576MHz crystal
—	9	Shunts
—	1	USB high-speed A-to-B cables, 5ft (1.5m)
—	1	PCB: MAX11040K EVALUATION KIT

MAX11040K Evaluation Kit/Daughterboard

Component Lists (continued)

MAX11040K Daughterboard

DESIGNATION	QTY	DESCRIPTION
AIN0-, AIN0+, AIN1-, AIN1+	4	75Ω, 4-pin BNC female jack receptacles, 0.250in spacing (top mount)
AVDD, AGND, DVDD, DGND	4	Uninsulated banana jacks
C1, C2, C4, C5, C10, C11, C13, C14	8	10pF ±5%, 50V C0G ceramic capacitors (0603) TDK C1608C0G1H100J
C3, C6, C7, C8, C12, C15, C16, C18	8	1μF ±10%, 10V X7R ceramic capacitors (0603) TDK C1608X7R1A105K
C9, C17, C19	3	0.01μF ±10%, 25V X7R ceramic capacitors (0603) Murata GRM188R71E103K
C20, C21	2	18pF ±5%, 50V C0G ceramic capacitors (0603) TDK C1608C0G1H180J
C22–C29	0	Not installed, capacitors (0603)
D1, D3	2	Yellow LEDs (0603)
D2, D4	2	Red LEDs (0603)
J1	1	Dual-row, 14-pin right-angle female connector (2 x 7)
J2	1	Dual-row, 14-pin right-angle male connector (2 x 7)

DESIGNATION	QTY	DESCRIPTION
J3	1	Dual-row, 20-pin header (2 x 10)
J4–J7	4	4-position terminal blocks
JU1, JU2, JU5, JU6, JU7	5	2-pin headers
JU3, JU4, JU11	3	3-pin headers
R1–R4	4	330Ω ±5% resistors (0603) (use lead-free parts only)
R5	1	2.2kΩ ±5% resistor (0603) (use lead-free parts only)
R6, R8	0	Not installed, resistors (0603)
R7	1	0Ω ±5% resistor (0603) (use lead-free parts only)
S1	1	Pushbutton switch
U1	1	4-channel ADC (38 TSSOP) Maxim MAX11040KGUU+
U2	1	D-flip flop
Y1	1	24.576MHz crystal, 18pF load
—	8	Shunts (JU1–JU5)
—	1	PCB: MAX11040KDB EVALUATION KIT

Evaluate: MAX11040K

MAX11040K EV Kit Files

FILE	DESCRIPTION
INSTALL.EXE	Installs the EV kit files on your computer
MAX11040K.EXE	Application program
LIBUSB.INF	USB device driver file
UNINST.INI	Uninstalls the EV kit software

Component Suppliers

SUPPLIER	PHONE	WEBSITE
Diodes Incorporated	805-446-4800	www.diodes.com
Murata Electronics North America, Inc.	770-436-1300	www.murata-northamerica.com
Panasonic Corp.	800-344-2112	www.panasonic.com
TDK Corp.	847-803-6100	www.component.tdk.com

Note: Indicate that you are using the MAX11040K when contacting these component suppliers.

MAX11040K Evaluation Kit/Daughterboard

Quick Start

Recommended Equipment

- MAX11040K EV kit (USB cable included)
- +3.3V analog supply voltage
- +3.3V digital supply voltage
- Signal source from -2.2V to +2.2V
- User-supplied Windows 2000/XP or Windows Vista PC with a spare USB port

Note: In the following sections, software-related items are identified by bolding. Text in **bold** refers to items directly from the EV kit software. Text in **bold and underlined** refers to items from the Windows operating system.

Procedure

The EV kit is fully assembled and tested. Follow the steps below to verify board operation. **Caution: Do not turn on power supplies until all connections are completed.**

- 1) Visit www.maxim-ic.com/evkitsoftware to download the latest version of the EV kit software, 11040KRxx.ZIP. Save the EV kit software to a temporary folder and uncompress the ZIP file.
- 2) Make sure that the shunts of all jumpers are in the default positions, as shown in Table 1.
- 3) Connect the analog voltage supply to the AVDD and AGND connectors.
- 4) Connect the digital voltage supply to the DVDD and DGND connectors.
- 5) Turn on the power supply.
- 6) Connect the negative terminal or ground terminal of the signal source to the negative input ('-') on J3 (AIN0 on U1), and the positive terminal of the signal source to the positive input ('+') on J3.
- 7) Set the signal source to generate a 60Hz, 2V peak-to-peak sinusoidal wave.
- 8) Install the MAX11040K evaluation software on your computer by running the **INSTALL.EXE** program inside the temporary folder. The program files are copied and icons are created for them in the Windows **Start | Programs** menu.
- 9) Connect the USB cable from the PC to the EV kit. A **Building Driver Database** window pops up in addition to a **New Hardware Found** message when installing the USB driver for the first time. If a window that is similar to the one described above is not seen after 30s, remove the USB cable from the EV kit and reconnect it. Administrator privileges are required to install the USB device driver on Windows.
- 10) Follow the directions of the **Add New Hardware Wizard** to install the USB device driver. Choose the **Search for the best driver for your device** option. Specify the location of the device driver to be **C:\Program Files\MAX11040K** using the **Browse** button. During device driver installation, Windows may show a warning message indicating that the device driver Maxim uses does not contain a digital signature. This is not an error condition and it is safe to proceed with installation. Refer to the USB_Driver_Help.PDF document included with the software for additional information.
- 11) Start the EV kit software by opening its icon in the **Start | Programs** menu.
- 12) Wait until the program automatically detects the MAX11040K hardware and displays the user-interface panel (Figure 1).
- 13) Press the **Start Conversion** button in the **Data Logging** group box.
- 14) Press the **Calculate** button and verify that the **Frequency** of 60Hz, the **MIN** value of -1V, and the **MAX** value of 1V are displayed in the **Calculation** group box.

MAX11040K Evaluation Kit/Daughterboard

Evaluate: MAX11040K

Table 1. Jumper Settings (EV Kit)

JUMPER	SHUNT POSITION	DESCRIPTION	WHEN TO USE THIS OPTION
JU1	1-2*	Connects the on-board crystal (Y1) to the crystal oscillator input and output of IC #1 (U1)	When the user wishes to stimulate IC #1 modulator clock by the on-board crystal (Y1)
	Open	Disconnects the on-board crystal from the IC (U1)	When the user wishes to stimulate IC #1 modulator clock by an external frequency
JU2	1-2	Connects the XOUT pin of the IC (U1) to the EX_XOUT pad	When the user-supplied external crystal connects to the IC (U1) through the EX_XIN and the EX_XOUT pads (see also JU6)
	Open*	Disconnects the EX_XOUT pad from the XOUT pin of the IC (U1)	When the user wishes to stimulate the IC (U1) modulator clock by the Y1 crystal
JU3	1-2	Connects the $\overline{\text{DRDYOUT}}$ pin of the IC (U2) to the CO_DRDYOUT pin on the cascading connector (J12)	Use this option when the IC daughterboard is connected to the IC EV kit
	2-3*	Connects the $\overline{\text{DRDYOUT}}$ pin of the IC (U2) to the interrupt pin (INT0) of the on-board controller	When there is no daughterboard connected to the board
JU6	1-2	Connects the XIN pin of the IC (U1) to the EX_XIN pad Note: User-supplied external crystal may be connected to the IC (U1) through the EX_XIN and the EX_XOUT pads	When the user wishes to stimulate the IC (U1) modulator clock by an external clock or crystal, not the Y1 crystal (see also JU2)
	Open*	Disconnects the EX_XIN pad from the XIN pin of the IC (U1)	When the user wishes to stimulate the IC (U1) modulator clock by the Y1 crystal
JU15	1-2	Connects the AIN0- pin of the IC (U1) to AGND for single-ended input-signal measurement	When the user wishes to make a single-ended signal measurement on AIN0+/AIN0-
	Open*	Disconnects the AIN0- pin of the IC (U1) from AGND	When the user wishes to make a differential signal measurement on AIN0+/AIN0-
JU16	1-2	Connects the AIN1- pin of the IC (U1) to AGND for single-ended input-signal measurement	When the user wishes to make a single-ended signal measurement on AIN1+/AIN1-
	Open*	Disconnects the AIN1- pin of the IC (U1) from AGND	When the user wishes to make a differential signal measurement on AIN1+/AIN1-
JU17	1-2	Connects the $\overline{\text{DRDYOUT}}$ pin of the IC (U2) to the $\overline{\text{SYNC}}$ signal (GP5) of the controller	When the user wishes to have the $\overline{\text{SYNC}}$ pin driven by the $\overline{\text{DRDYOUT}}$
	Open*	Disconnects the $\overline{\text{DRDYOUT}}$ pin of the IC (U2) from the $\overline{\text{SYNC}}$ signal (GP5) of the controller	When the user wishes to have the $\overline{\text{SYNC}}$ pin driven by the controller
JU18	1-2	Connects the user-supplied crystal (Y4) to the crystal-oscillator input and output of the IC (U2) Note: Y4 is not loaded by default, but can be loaded by the user	When the user wishes to clock the IC (U2) by the Y4 crystal (must be loaded by the user)
	Open*	Disconnects the user-supplied crystal (Y4) from the IC (U2)	When the user does not wish to stimulate the IC (U2) modulator clock by the Y4 crystal

MAX11040K Evaluation Kit/Daughterboard

Table 1. Jumper Settings (EV Kit) (continued)

JUMPER	SHUNT POSITION	DESCRIPTION	WHEN TO USE THIS OPTION
JU19	1-2*	Connects the CLKOUT of the IC (U1) to the XIN pin of the MAX11040K (U2)	When the user wishes to cascade U2 with U1
	Open	Disconnects the CLKOUT of the IC (U1) from the XIN pin of the MAX11040K (U2)**	When the user does not wish to cascade U2 with U1

*Default position.

**Y4 is not loaded by default, but can be loaded by the user.

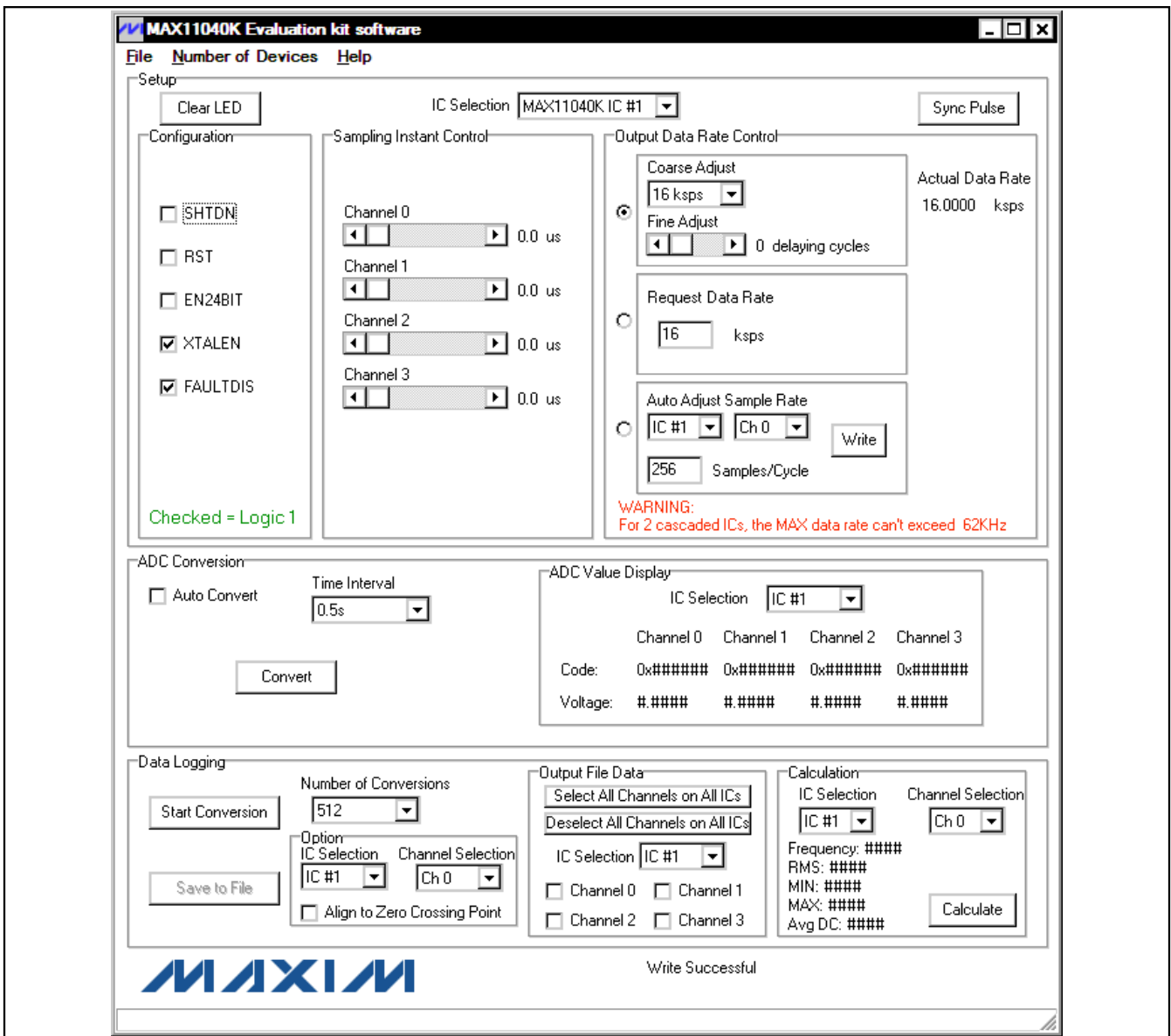

Figure 1. MAX11040K EV Kit Main Window

MAX11040K Evaluation Kit/Daughterboard

Detailed Description of Software

The MAX11040K EV kit's main window is shown in Figure 1. The **Setup** group box, located at the top of the window, contains **Configuration**, **Sampling Instant Control**, and **Output Data Rate Control** group boxes. Functions related to reading single-sample ADC values in the **ADC Conversion** group box are located in the middle section. Data-logging functions and data calculation are in the **Data Logging** group box, located at the bottom of the main window.

Up to five devices can be cascaded by using the daughterboards. Select the number of cascaded ICs from the **Number of Devices** menu item.

Setup

All the settings in the **Setup** group box correspond to the registers of the IC specified in the **IC Selection** drop-down list. In the **IC Selection** drop-down list, **MAX11040K IC #1** and **MAX11040K IC #2** represent the ICs (U1 and U2) on the EV kit. **MAX11040K IC #3**, **MAX11040K IC #4**, and **MAX11040K IC #5** represent the ICs on the optionally cascaded daughterboards.

When the EV kit software starts up, or when a different IC is selected in the **IC Selection** drop-down list, the **Configuration**, **Sampling Instant Control**, and **Output Data Rate Control** group boxes display the content of the IC specified in the **IC Selection** drop-down list.

Configuration

In the **Configuration** group box, the user can change the value of the configuration register in the selected IC.

Each checkbox in the **Configuration** group box corresponds to a bit in the configuration register. Click on the checkbox to toggle each bit.

Sampling Instant Control

Adjust the appropriate scrollbars in the **Sampling Instant Control** group box to set the sampling instant delay for the input channels.

Output Data Rate Control

There are three panels in the **Output Data Rate Control** group box, and each one of them has a different way to set up the data rate of the IC. The user can select one of them by checking the corresponding radio button on the left of the panel.

To set the sample rate by directly controlling the ADC's register (coarse adjust and fine adjust), use the first panel at the top of the **Output Data Rate Control**

group box. Select the coarse-adjusted output data rate in the **Coarse Adjust** drop-down list, and adjust the **Fine Adjust** scrollbar to set up the output data rate. The **Coarse Adjust** drop-down list and the **Fine Adjust** scrollbar correspond to the output data rate coarse adjust register and the output data rate fine adjust register, respectively. The actual data rate is displayed in the **Actual Data Rate** label.

To set the sample rate by entering a desired sample rate, and letting the EV kit software calculate the closest possible sample rate, use the **Request Data Rate** edit box. Enter the desired data rate into the **Request Data Rate** edit box and press the enter key. The program sets up the closest possible data rate automatically. The actual data rate is displayed in the **Actual Data Rate** label.

To set the sample rate by letting the software detect the input frequency, and adjust the sample rate to a desired number of samples per cycle, use the **Auto Adjust Sample Rate** group box. The software detects the frequency of the input signal on any channel selected in the drop-down list. Set up the data rate based on how many samples per input-signal cycle was requested in the **Samples/Cycle** edit box. The actual data rate is displayed in the **Actual Data Rate** label.

ADC Conversion

The **ADC Value Display** group box, shown in the **ADC Conversion** group box, displays the output data codes and the calculated voltage values for a single sample of all of the channels on the IC specified in the **IC Selection** drop-down list. Pressing the **Convert** button in the **ADC Conversion** group box updates the status of the **ADC Value Display** group box.

Check the **Auto Convert** checkbox to automatically and repeatedly read the current ADC value at a rate set by the **Time Interval** drop-down list.

Data Logging

Start Conversion

The **Data Logging** group box is located at the bottom of the window. The user can select the desired number of conversions in the **Number of Samples** drop-down list. Press the **Start Conversion** button in the **Data Logging** group box to start sampling at the rate that was set by the **Output Data Rate Control** group box.

Output File Data

The **Save to File** button is not active until the sampling is done. After sampling is finished, and before pressing

MAX11040K Evaluation Kit/Daughterboard

the **Save to File** button, the user needs to select in the **Output File Data** group box which channels will have their sampled data saved into the file. The software keeps a record of channel selections for each IC. Select the IC you wish to select in the **IC Selection** drop-down list, to display and allow modification of channel selection for that IC. Press the **Select All Channels on All ICs** button to check all the checkboxes in the **Output File Data** group box for all ICs. Press the **Deselect All Channels on All ICs** button to clear all the checkboxes in the **Output File Data** group box. Press the **Save to File** button to save the data from the selected channels into a file.

Zero-Crossing Alignment Option

In the **Option** group box, when the **Align to Zero Crossing Point** checkbox is checked, the program detects the rising zero-crossing point in the sampled data of the channel specified in the **IC Selection** and **Channel Selection** drop-down lists. When the **Save to File** button is pressed, the program saves the sampled data starting from the rising zero-crossing point.

Calculation

After sampling is finished, press the **Calculate** button to calculate the **Frequency**, **RMS**, **MIN**, **MAX**, and **Avg DC** of the input signal of the channel specified in the **IC Selection** and **Channel Selection** drop-down lists. The calculation for **Frequency** uses a simple algorithm that has limitations. The **Frequency** is calculated by measuring the time between two rising zero-crossing points. An error may show up in circumstances where DC offset is on the order of the input-signal amplitude, or if there is significant noise or other frequency content in the signal that creates multiple zero crossings near the fundamental crossing. To calculate these results for a different channel, change the **IC Selection** and **Channel Selection** drop-down list and press the **Calculate** button.

Clear LED

When any of the LEDs on the EV kit and the daughterboard are on, press the **Clear LED** button to turn off the LEDs after the overflow and the overvoltage faults are cleared.

Sync Pulse

Press the **Sync Pulse** button to synchronize the output data timing for all cascaded devices.

Detailed Description of Hardware

MAX11040K EV Kit

The MAX11040K EV kit board provides a proven layout for evaluating the IC's 4-channel, simultaneous-sampling ADC. The EV kit comes with two MAX11040KGUU+s installed. Eight terminal blocks are provided on the EV kit for all AIN inputs of the on-board ICs. Four BNC connectors are also available for the AIN0 and AIN1 inputs of IC #1 (U1).

Up to three additional parts can be connected to the EV kit to increase the number of input channels, by cascading the daughterboards to the EV kit.

See the *Daughterboard* section for more information.

Power Supply

Two separate power supplies are required to power up the EV kit. Connect the analog voltage supply (from +3V to +3.6V) to the AVDD connector and the analog ground to the AGND connector. Connect the digital voltage supply (from +2.7V to AVDD) to the DVDD connector and the digital ground to the DGND connector on the EV kit.

LEDs

There are four LED indicators (D1–D4) on the EV kit. D1 and D2 LEDs reflect the real-time logic levels on the **FAULT** and **OVFLW** pins, respectively. D3 and D4 LEDs latch on the fault conditions on the **FAULT** and **OVFLW** pins, respectively. When D3 or D4 is turned on, press the **Clear LED** button in the EV kit software or press the on-board pushbutton (S2) to turn off the LEDs after the faults are cleared. All IC **FAULT** and **OVFLW** pins are open drain and respectively connected in a wire-ORed configuration.

Daughterboard

The daughterboard comes with one MAX11040KGUU+ installed. The user can cascade the daughterboard to the EV kit to increase the number of input channels. The software supports up to three daughterboards cascading to the EV kit.

Four terminal blocks are provided on the daughterboard for all AIN inputs of the on-board ICs. Four BNC connectors are also available for the AIN0 and AIN1 inputs of the IC (U1).

MAX11040K Evaluation Kit/Daughterboard

Evaluate: MAX11040K

Cascade

Carefully connect the boards by aligning the EV kit's 14-pin connector (J12) with the 14-pin header (J1) of the daughterboard. Gently press them together. The two boards should be flush against each other. If more daughterboards need to be cascaded to the EV kit, connect the 14-pin connector (J2) of the last daughterboard with the 14-pin header (J1) of the additional daughterboard.

Place the shunt on pins 2-3 of JU3 on the last daughterboard (the one farthest away from the EV kit board), and place the shunt on pins 1-2 of JU3 on all other boards (including the EV kit board).

Power Supply

Two separate power supplies are required to power up the daughterboard. Connect the analog voltage supply (from +3V to +3.6V) and the analog ground to the

AVDD and AGND connectors, respectively. Connect the digital voltage supply (from +2.7V to AVDD) and the digital ground to the DVDD and DGND connectors on the daughterboard, respectively.

LEDs

There are four LED indicators (D1–D4) on the daughterboard. D1 and D2 LEDs reflect the real-time logic levels on the $\overline{\text{FAULT}}$ and the $\overline{\text{OVRFLW}}$ pins, respectively. D3 and D4 LEDs latch on the fault conditions on the $\overline{\text{FAULT}}$ and the $\overline{\text{OVRFLW}}$ pins, respectively. When D3 or D4 is turned on, press the **Clear LED** button in the EV kit software (Figure 1) or press the on-board pushbutton (S2) to turn off the LEDs after the faults are cleared. All IC $\overline{\text{FAULT}}$ and $\overline{\text{OVRFLW}}$ pins are open drain and respectively connected in a wired-ORed configuration.

Table 2. Jumper Settings (Daughterboard)

JUMPER	SHUNT POSITION	DESCRIPTION	WHEN TO USE THIS OPTION
JU1	1-2	Connects the on-board crystal (Y1) to the crystal oscillator input and output of the IC (U1)	When the user wishes to stimulate the IC (U1) modulator clock by the on-board crystal (Y1)
	Open*	Disconnects the on-board crystal from the IC (U1)	When the user does not wish to stimulate the IC (U1) modulator clock by the on-board crystal (Y1)
JU2	1-2	Connects the XOUT pin of the IC (U1) to the EX_XOUT pad	When the user-supplied external crystal connects to the IC (U1) through the EX_XIN and the EX_XOUT pads
	Open*	Disconnects the EX_XOUT pad from the XOUT pin of the IC (U1)	When an external crystal is not used
JU3	1-2	Connects the $\overline{\text{DRDYOUT}}$ pin of the IC (U1) to the CO_DRDYOUT pin on the connector (J2)	Use this option when more IC daughterboards need to be cascaded
	2-3*	Connects the $\overline{\text{DRDYOUT}}$ pin of the IC (U1) to the interrupt pin (INT0) of the on-board controller	Use this option on the last IC daughterboard that cascades to the IC EV kit
JU4	1-2*	Connects the XIN pin of the IC (U1) to the CI_XIN pin on the J1 connector Note: CI_XIN carries the CLKOUT signal from the previous cascaded board	When the user wishes to stimulate the IC (U1) modulator clock by the CLKOUT of the previous cascaded board
	2-3	Connects the XIN pin of the IC (U1) to the EX_XIN pad Note: User-supplied external crystal may be connected to the IC (U1) through the EX_XIN and the EX_XOUT pads	When the user does not wish to stimulate the IC (U1) modulator clock by the CLKOUT of the previous cascaded board

MAX11040K Evaluation Kit/Daughterboard

Table 2. Jumper Settings (Daughterboard) (continued)

JUMPER	SHUNT POSITION	DESCRIPTION	WHEN TO USE THIS OPTION
JU5	1-2	Connects the AIN0- pin of the IC (U1) to the AGND pin for single-ended input signal measurement	When the user wishes to make a single-ended signal measurement on AIN0+/AIN0-
	Open*	Disconnects the AIN0- pin of the IC (U1) from the AGND pin	When the user wishes to make a differential signal measurement on AIN0+/AIN0-
JU6	1-2	Connects the AIN1- pin of the IC (U1) to the AGND pin for single-ended input signal measurement	When the user wishes to make a single-ended signal measurement on AIN1+/AIN1-
	Open*	Disconnects the AIN1- pin of the IC (U1) from the AGND	When the user wishes to make a differential signal measurement on AIN1+/AIN1-
JU7	1-2	Connects the $\overline{\text{DRDYOUT}}$ pin of the IC (U1) to the SYNC signal (GP5) of the controller	When the user wishes to have the $\overline{\text{SYNC}}$ pin driven by $\overline{\text{DRDYOUT}}$
	Open*	Disconnects the $\overline{\text{DRDYOUT}}$ pin of the IC (U1) from the $\overline{\text{SYNC}}$ signal (GP5) of the controller	When the user wishes to have the $\overline{\text{SYNC}}$ pin driven by the controller
JU11	1-2	Connects the CLKOUT pin of the IC (U1) to the CO_CLKOUT on the J2 connector Note: CO_CLKOUT carries the CLKOUT signal to the next cascaded daughterboard	When the user wishes to carry the CLKOUT of U1 to the next cascaded board
	2-3*	Connects the CI_XIN pin on the J1 connector to the CO_CLKOUT pin on the J2 connector Note: CI_XIN carries the CLKOUT signal from the previous cascaded board	When the user wishes to carry the frequency from the previous cascaded board to the next cascaded board

*Default position.

MAX11040K Evaluation Kit/Daughterboard

Evaluate: MAX11040K

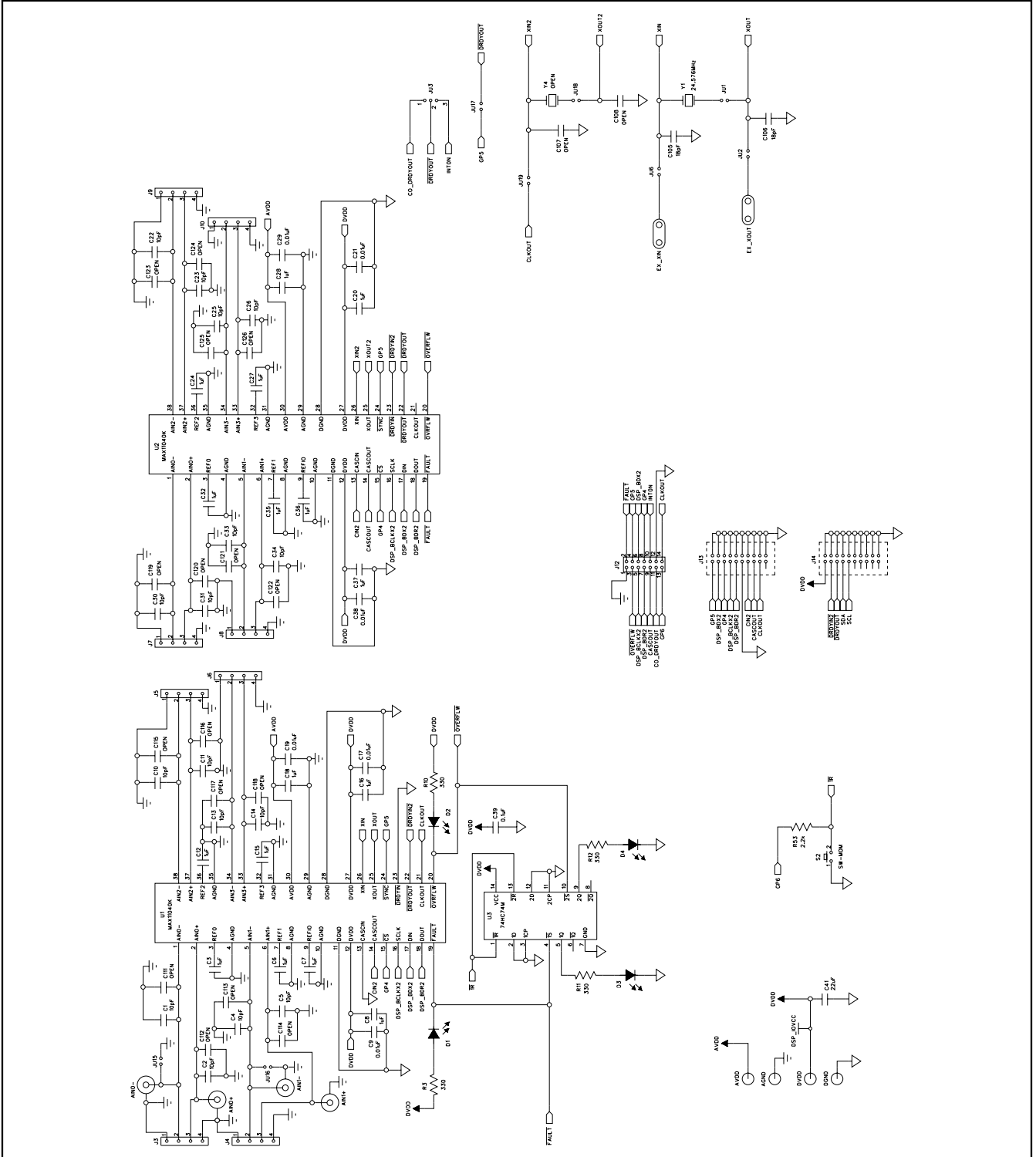

Figure 2a. MAX11040K EV Kit Schematic (Sheet 1 of 4)

MAX11040K Evaluation Kit/Daughterboard

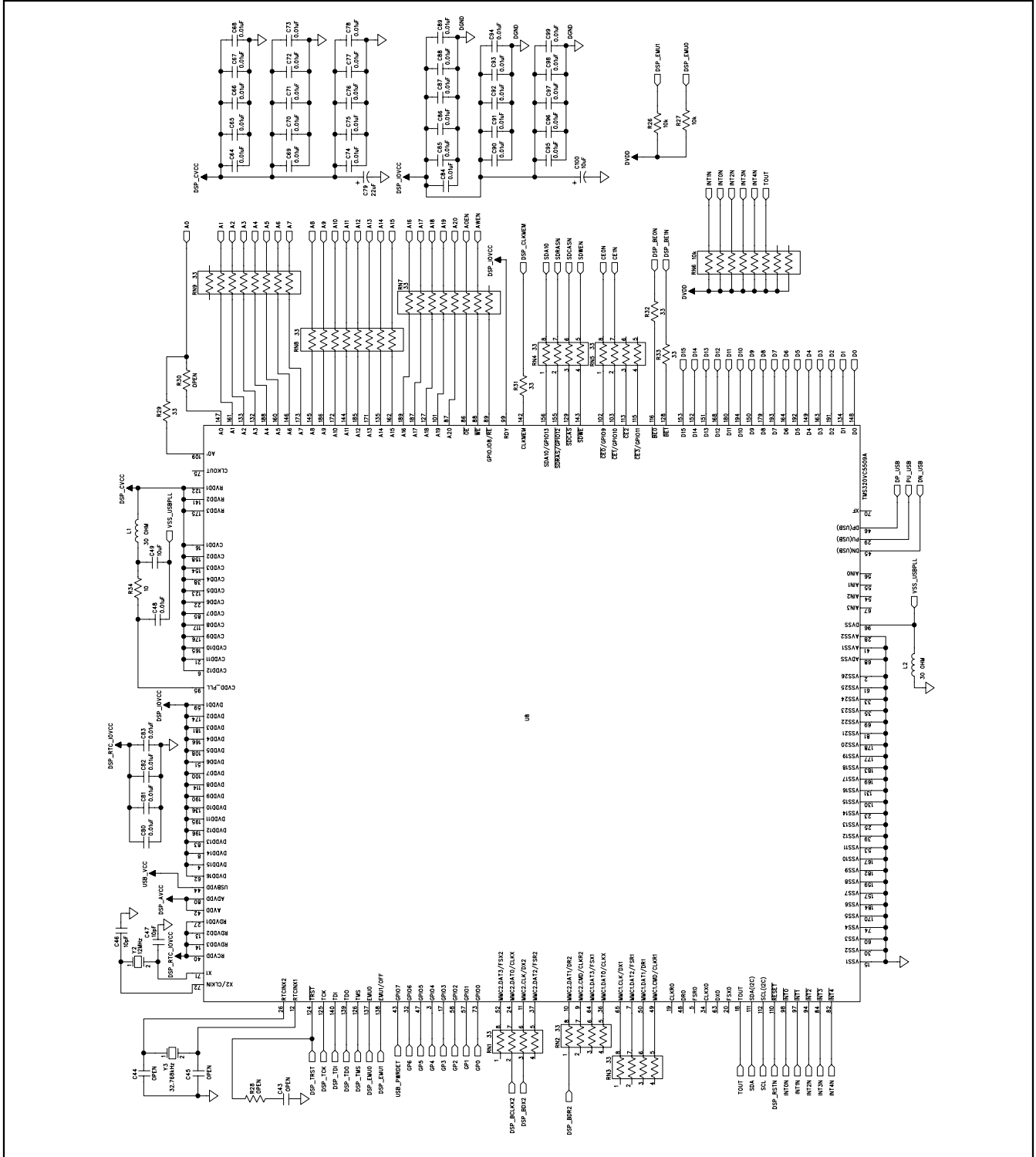

Figure 2b. MAX11040K EV Kit Schematic (Sheet 2 of 4)

MAX11040K Evaluation Kit/Daughterboard

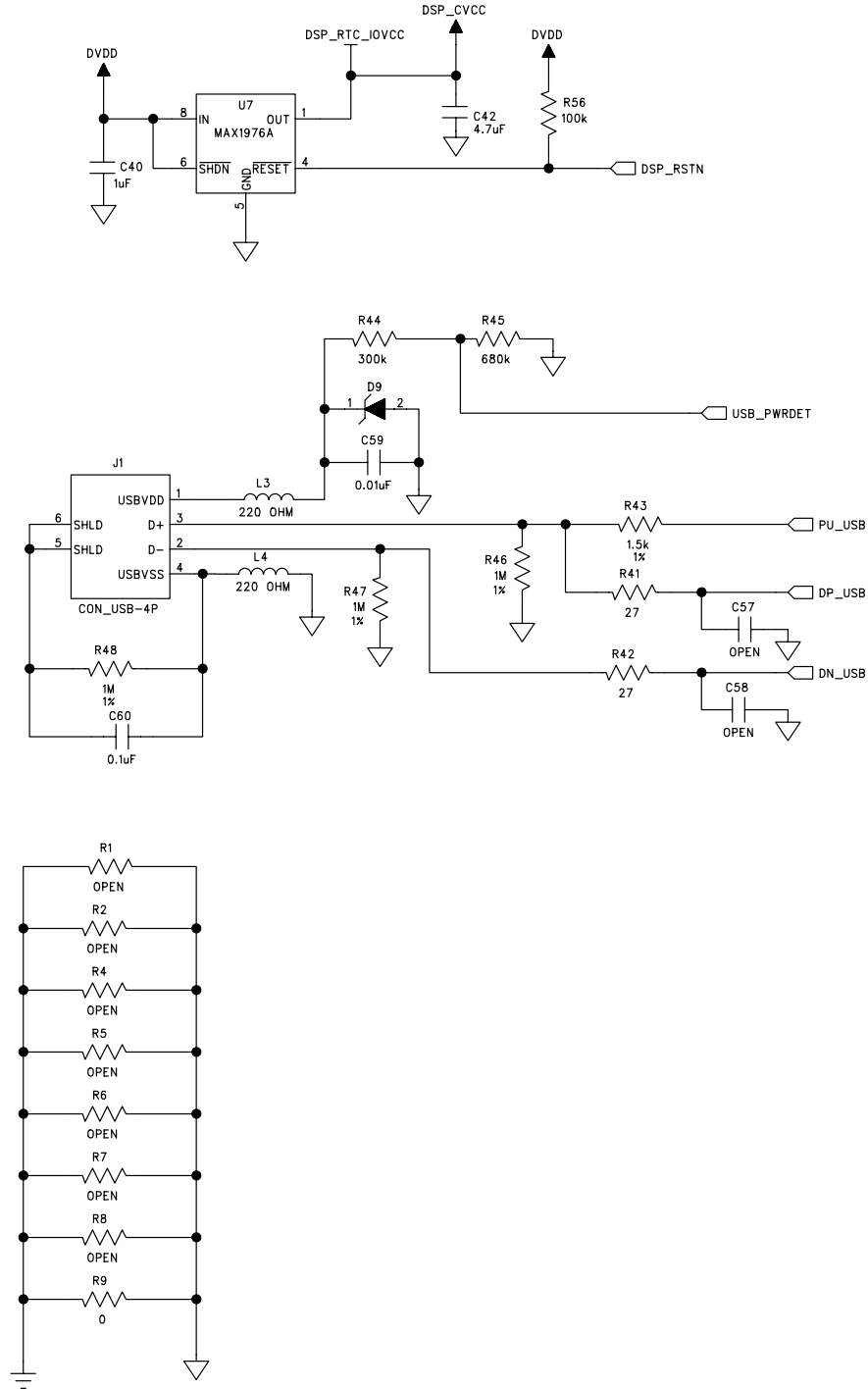

Figure 2d. MAX11040K EV Kit Schematic (Sheet 4 of 4)

MAX11040K Evaluation Kit/Daughterboard

Evaluate: MAX11040K

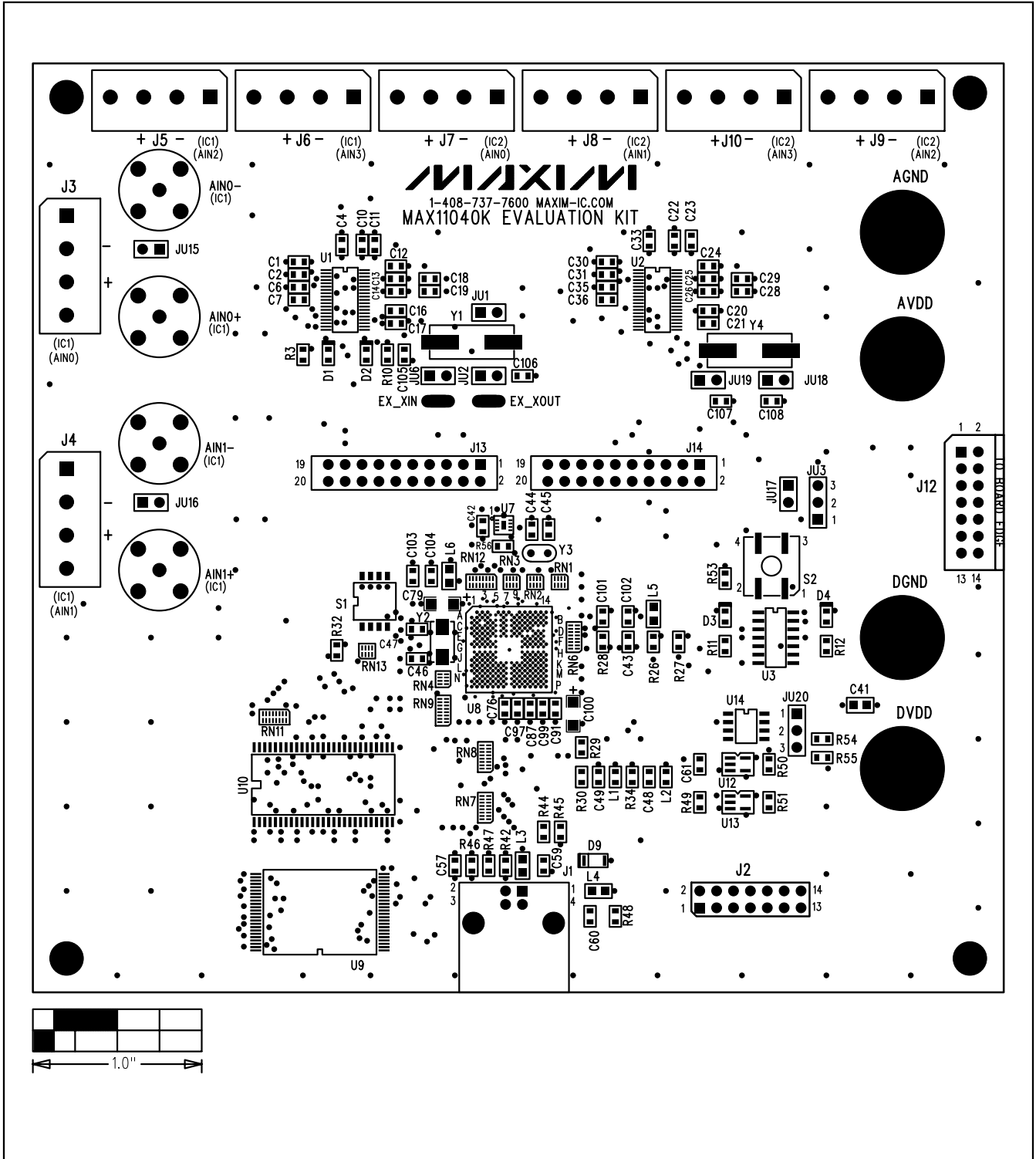

Figure 3. MAX11040K EV Kit Component Placement Guide—Top

MAX11040K Evaluation Kit/Daughterboard

Evaluate: MAX11040K

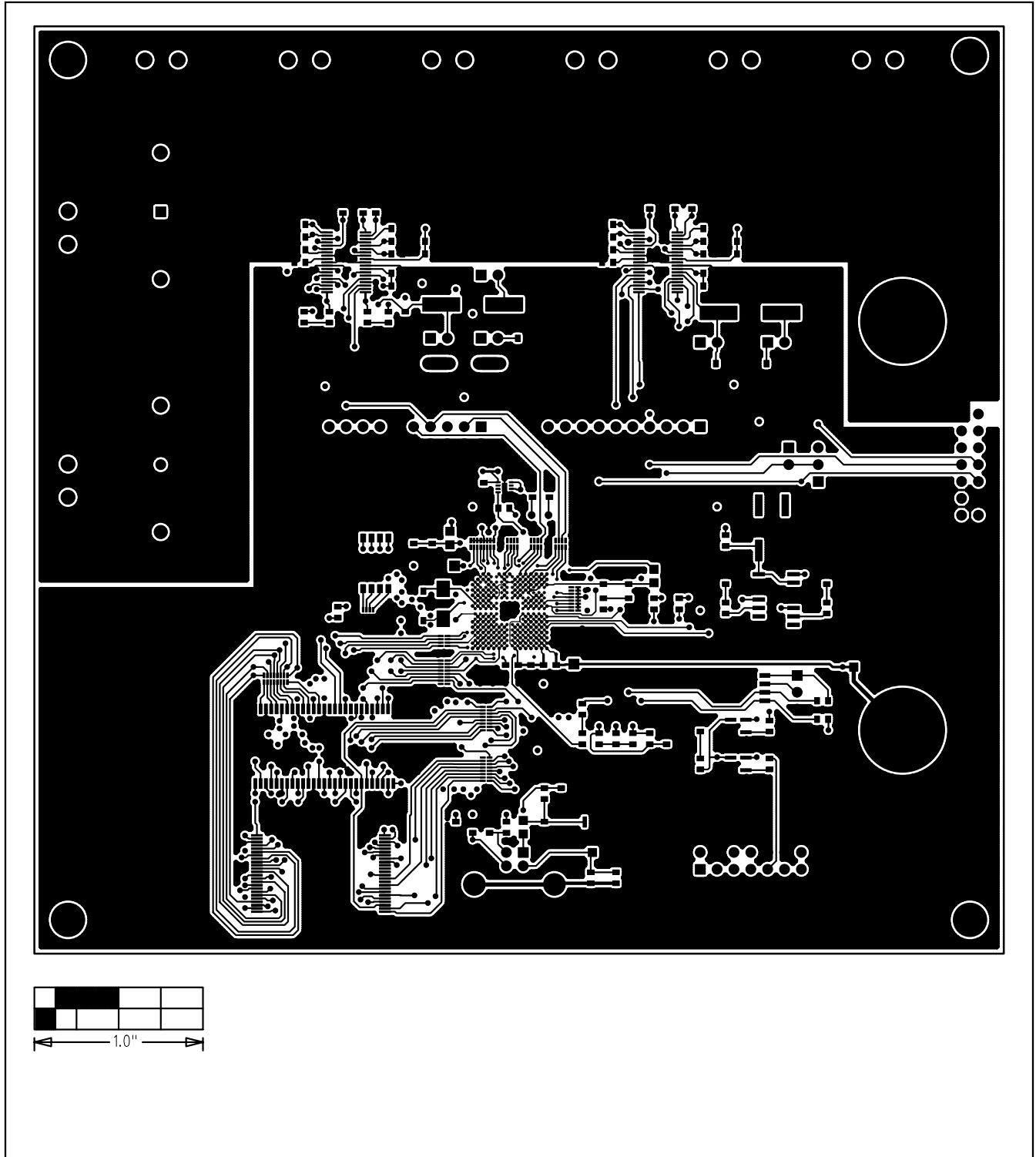

Figure 4. MAX11040K EV Kit PCB Layout—Component Side

MAX11040K Evaluation Kit/Daughterboard

Evaluate: MAX11040K

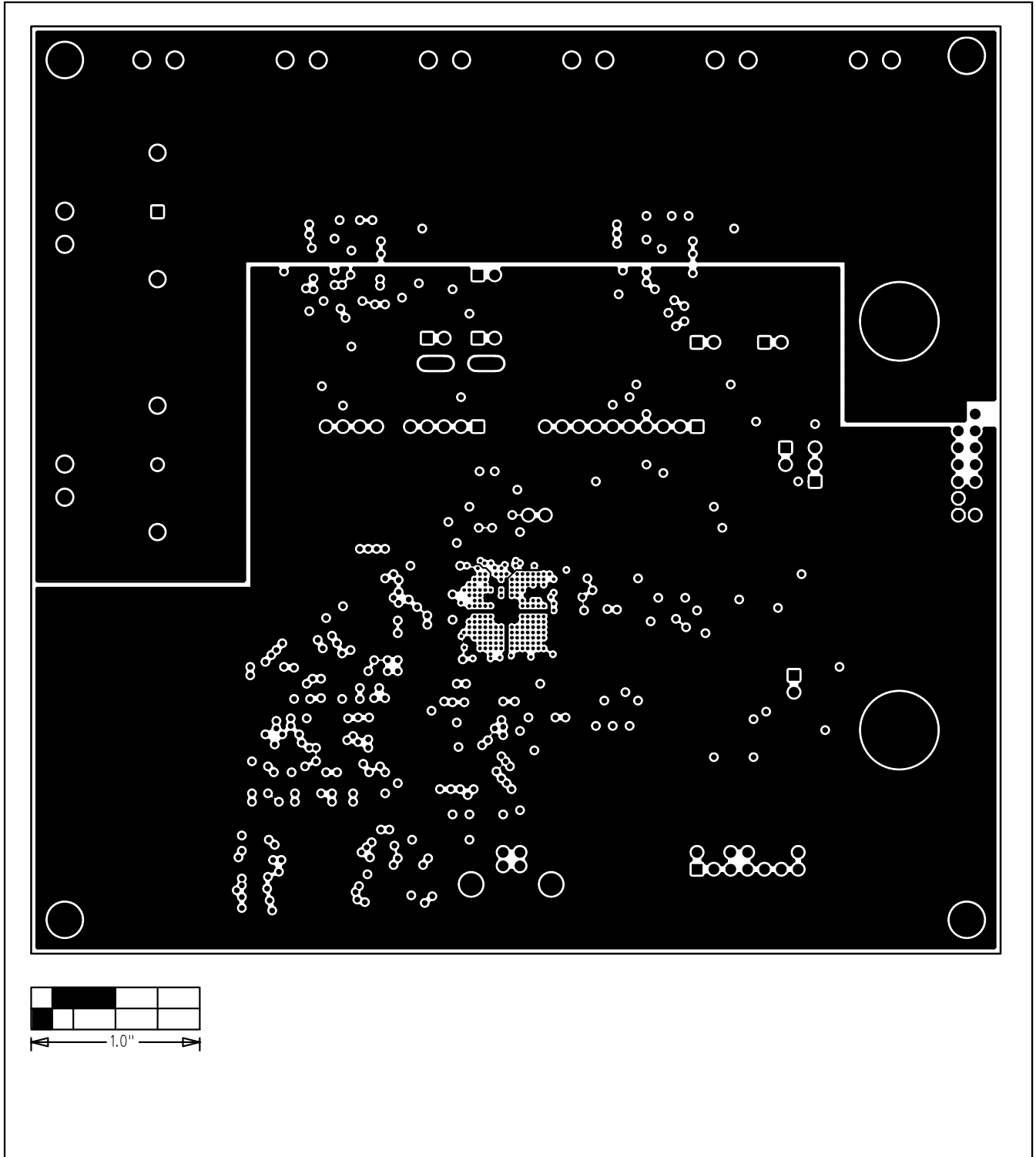

Figure 5. MAX11040K EV Kit PCB Layout—Layer 2

MAX11040K Evaluation Kit/Daughterboard

Evaluate: MAX11040K

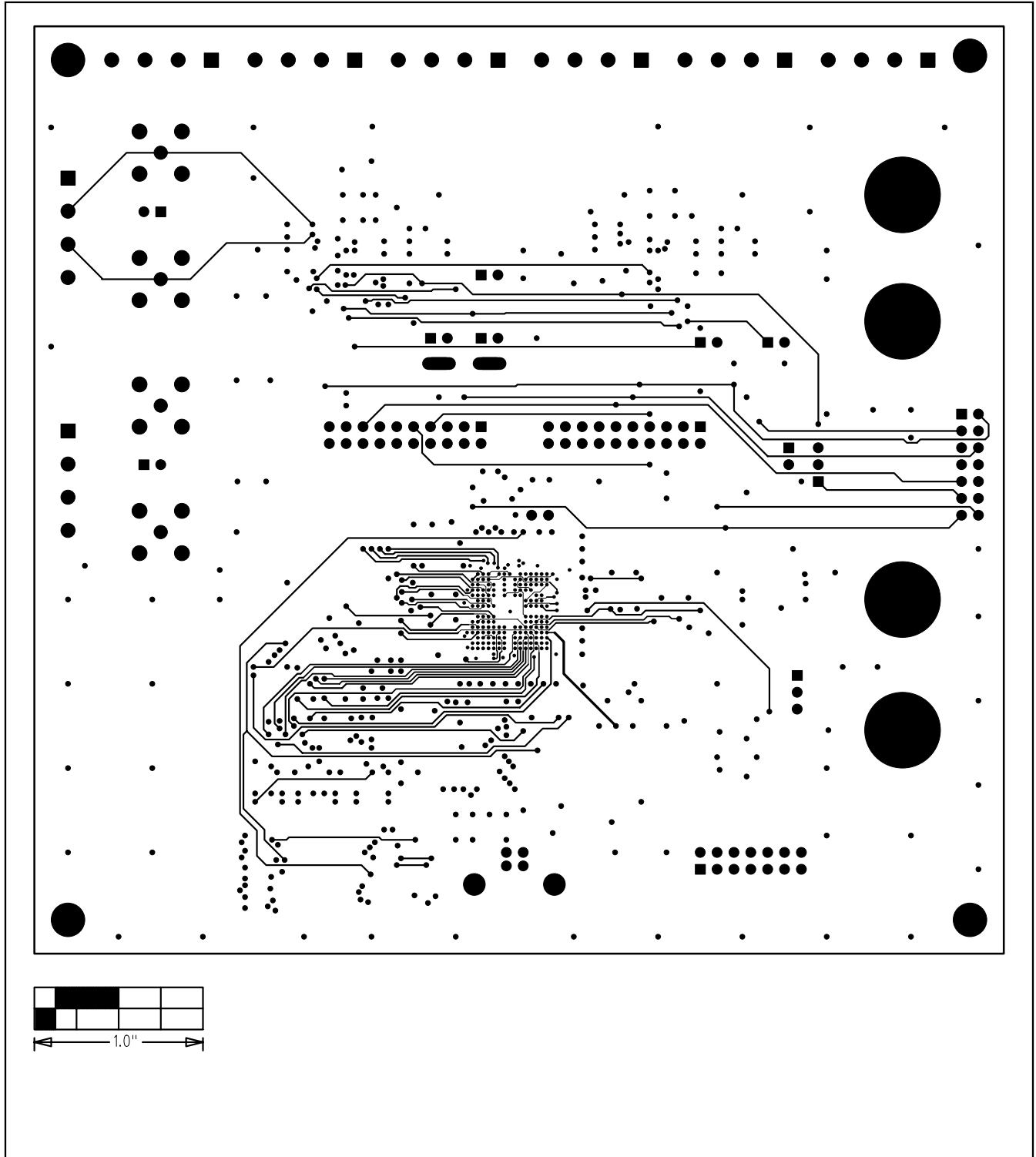

Figure 6. MAX11040K EV Kit PCB Layout—Layer 3

MAX11040K Evaluation Kit/Daughterboard

Evaluate: MAX11040K

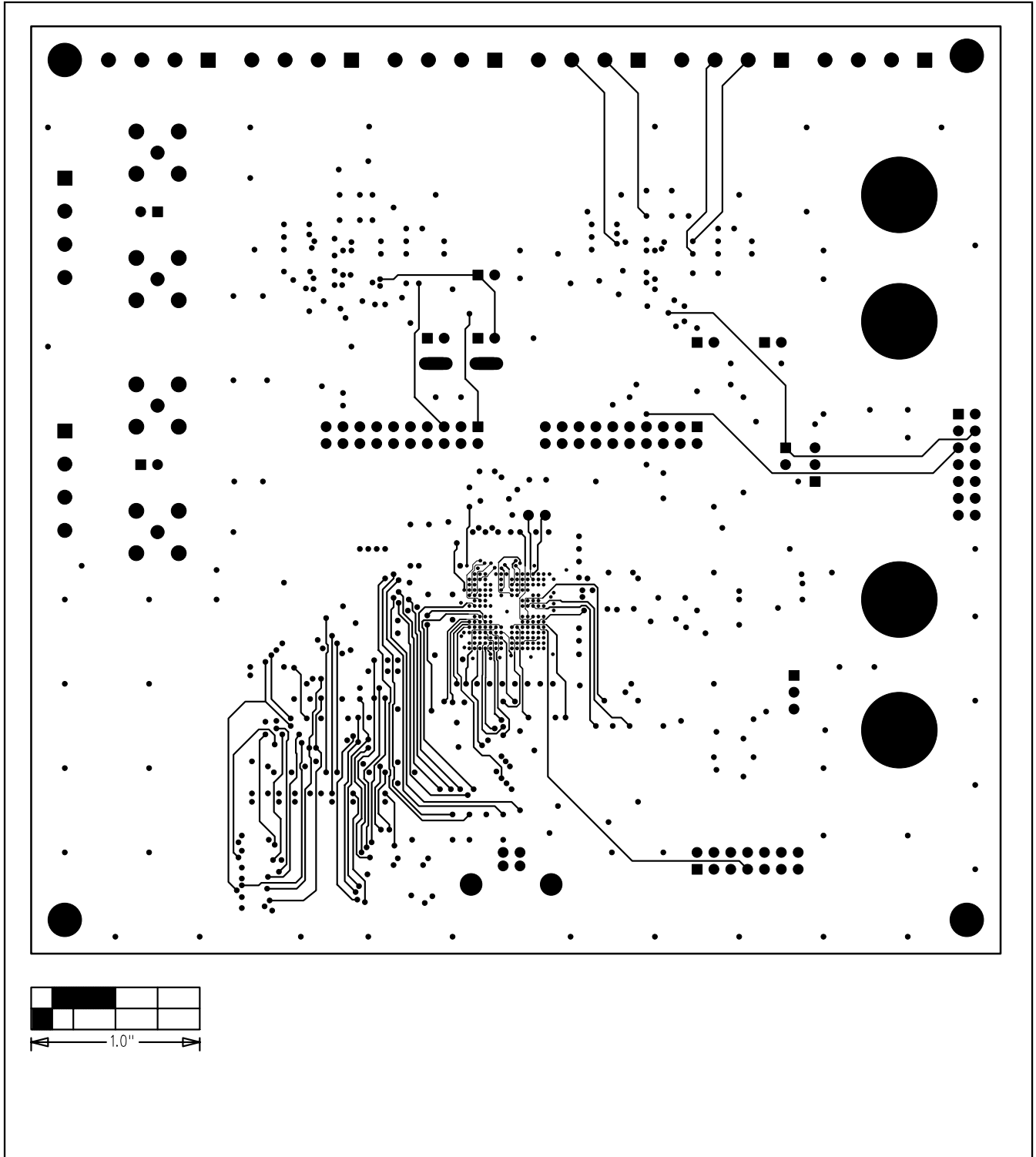

Figure 7. MAX11040K EV Kit PCB Layout—Layer 4

MAX11040K Evaluation Kit/Daughterboard

Evaluate: MAX11040K

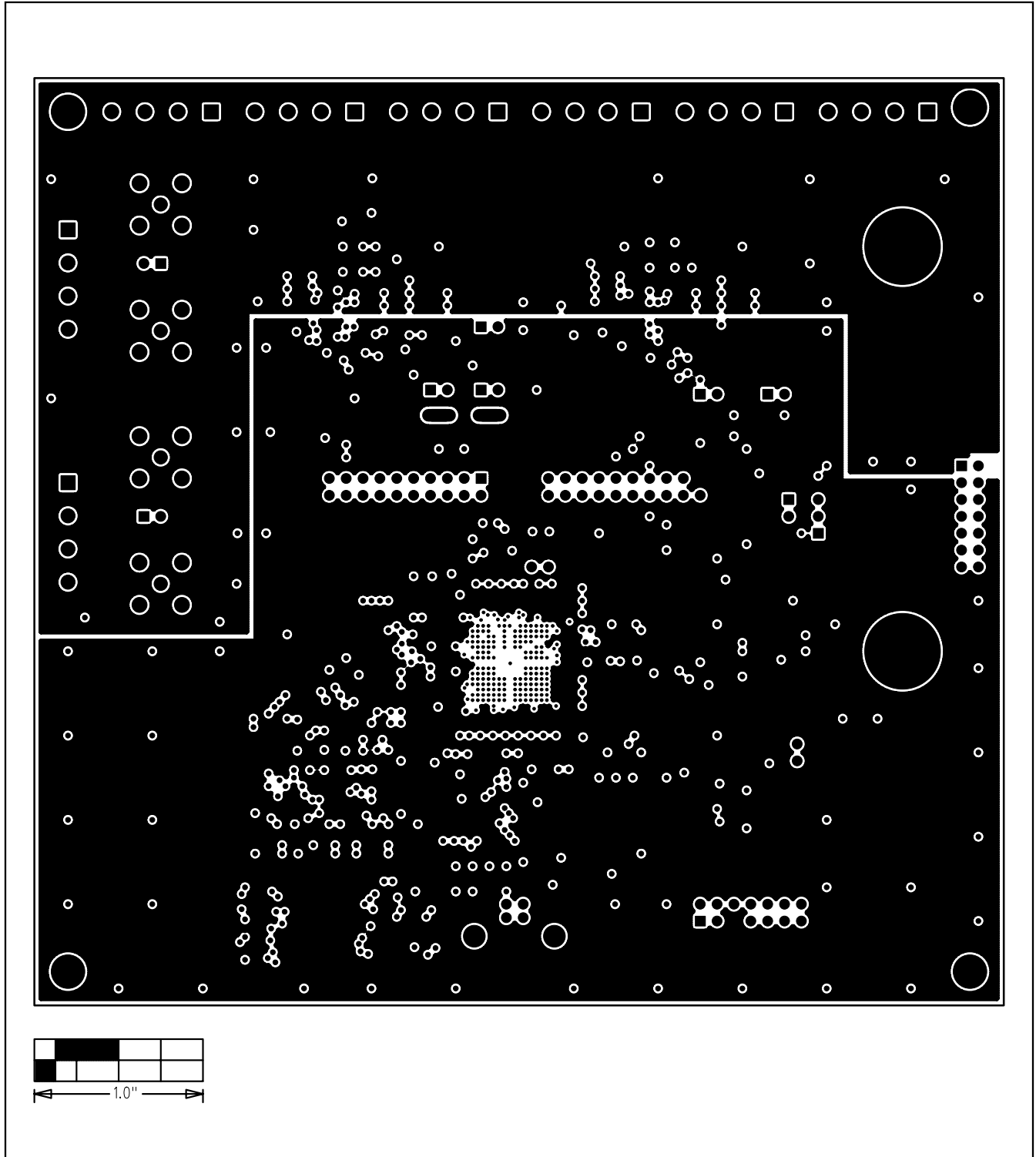

Figure 8. MAX11040K EV Kit PCB Layout—Layer 5

MAX11040K Evaluation Kit/Daughterboard

Evaluate: MAX11040K

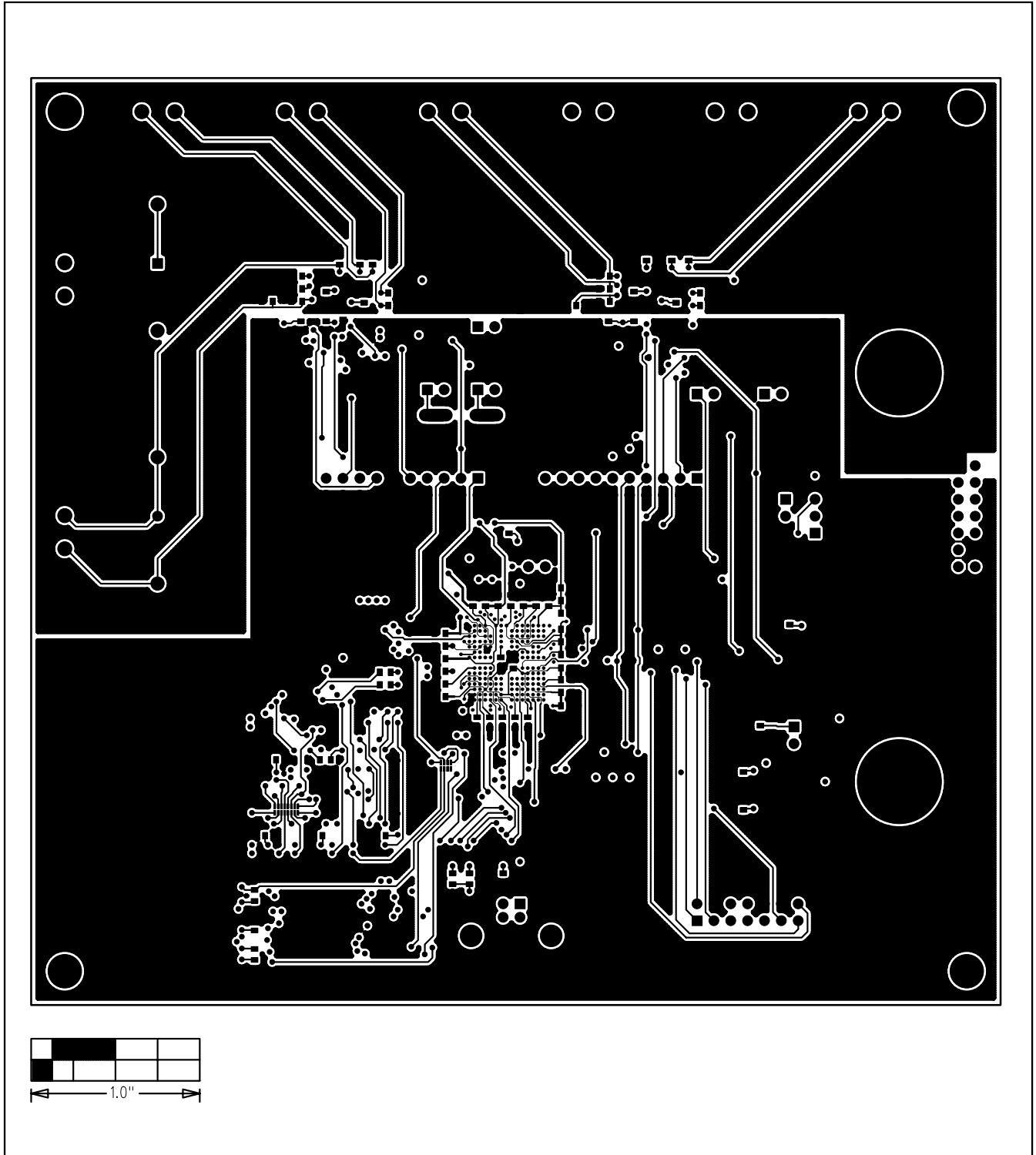

Figure 9. MAX11040K EV Kit PCB Layout—Bottom Side

MAX11040K Evaluation Kit/Daughterboard

Evaluate: MAX11040K

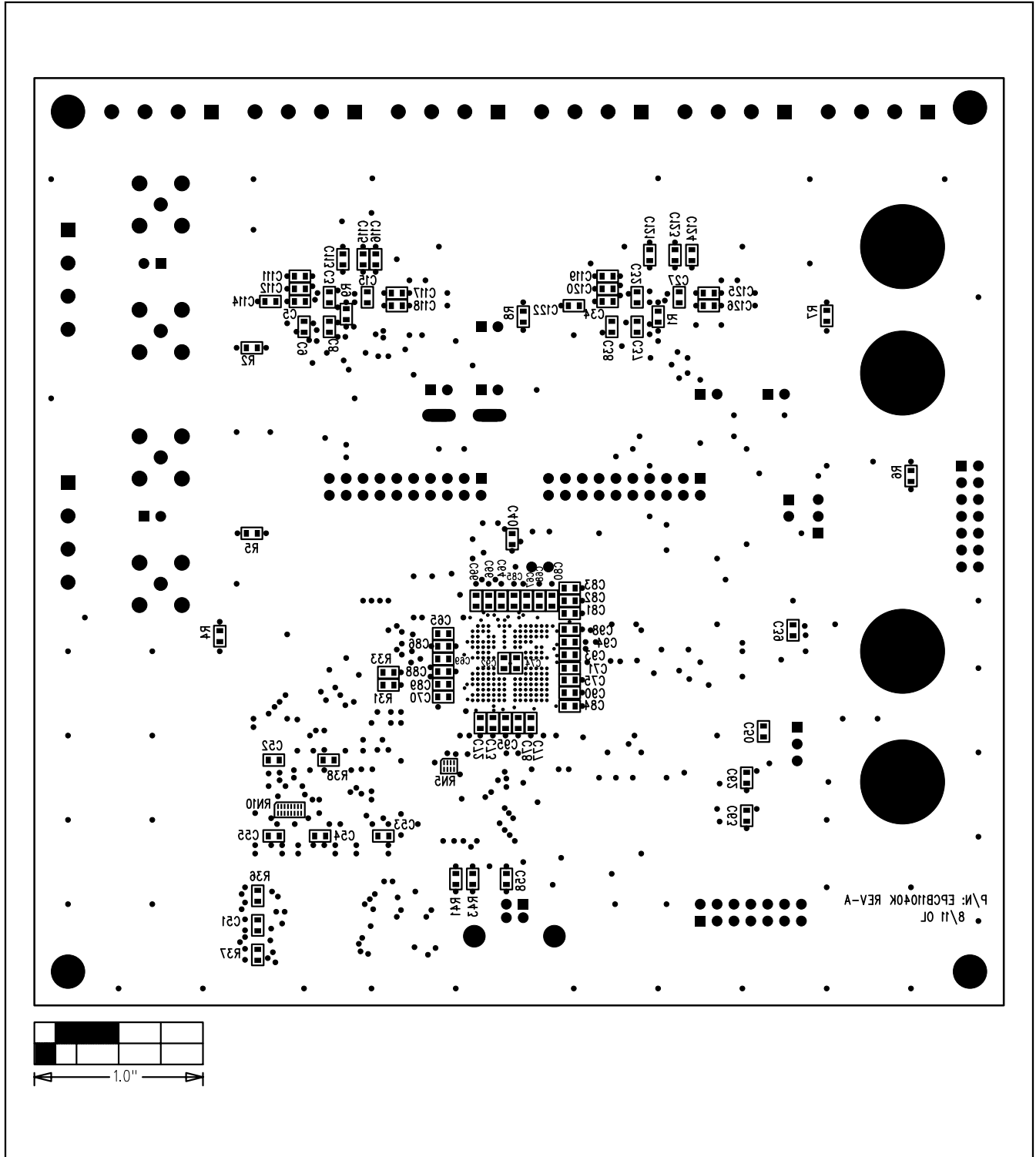

Figure 10. MAX11040K EV Kit Component Placement Guide—Bottom

MAX11040K Evaluation Kit/Daughterboard

Evaluate: MAX11040K

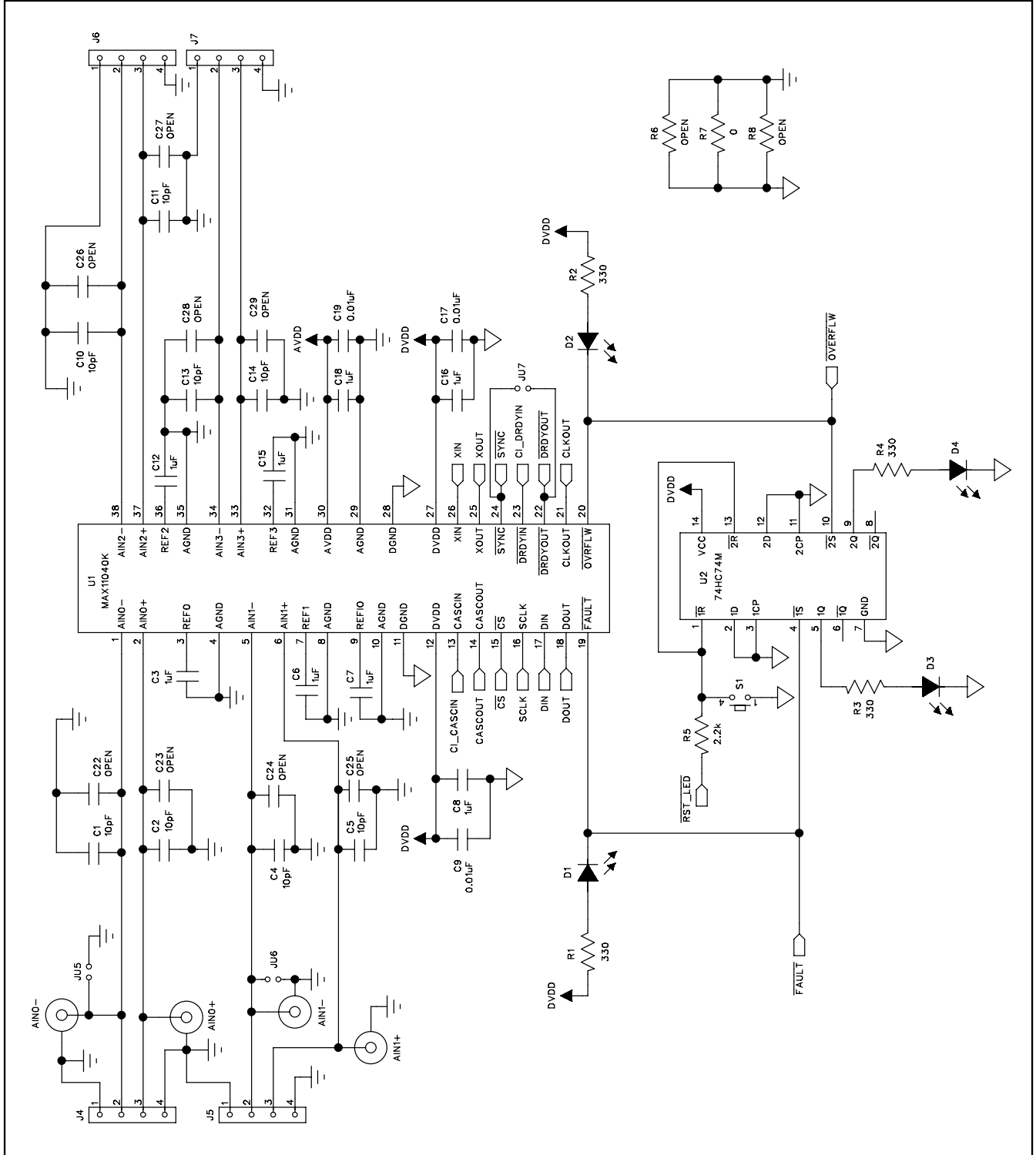

Figure 11a. MAX11040K Daughterboard Schematic (Sheet 1 of 2)

MAX11040K Evaluation Kit/Daughterboard

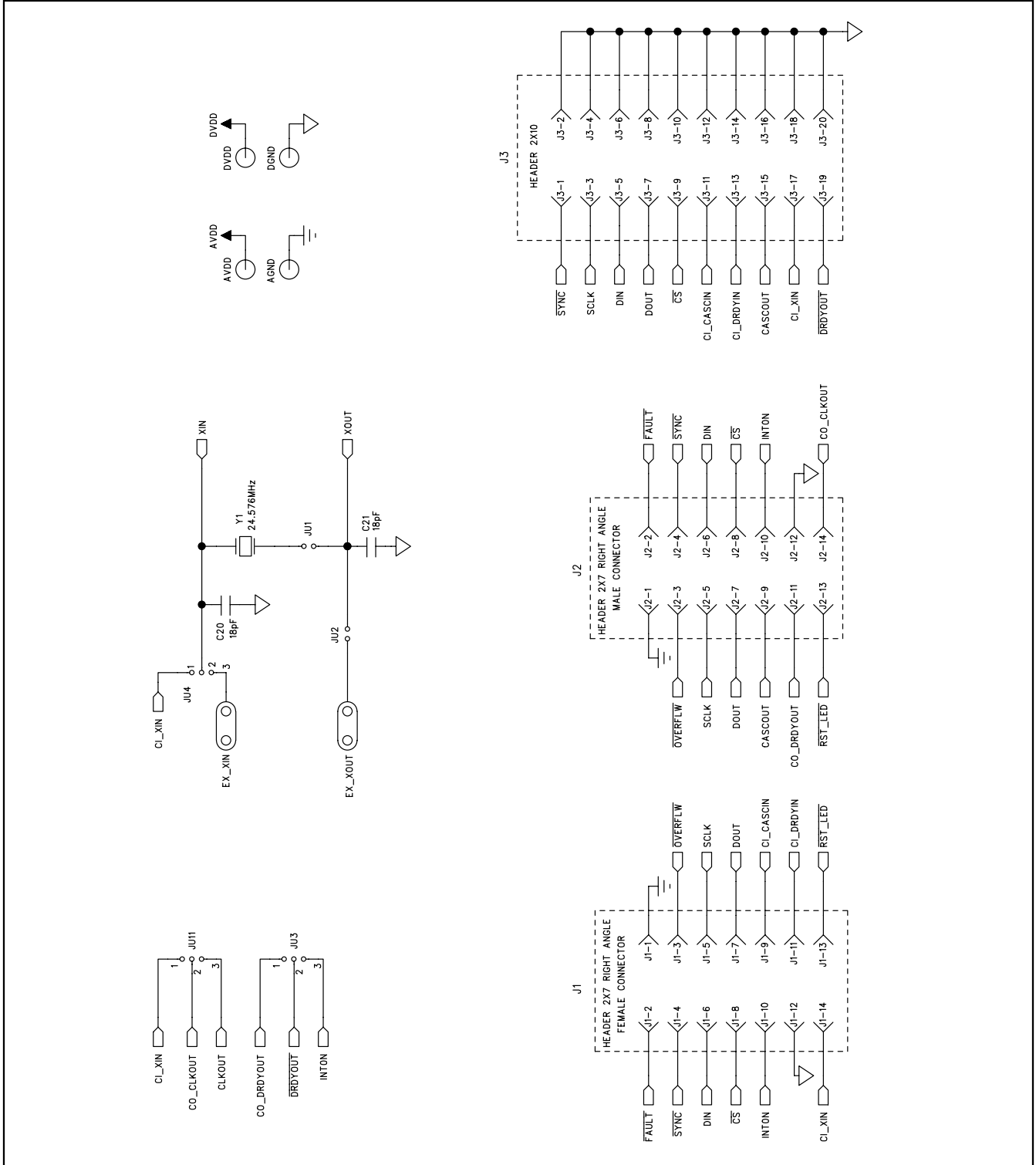

Figure 11b. MAX11040K Daughterboard Schematic (Sheet 2 of 2)

MAX11040K Evaluation Kit/Daughterboard

Evaluate: MAX11040K

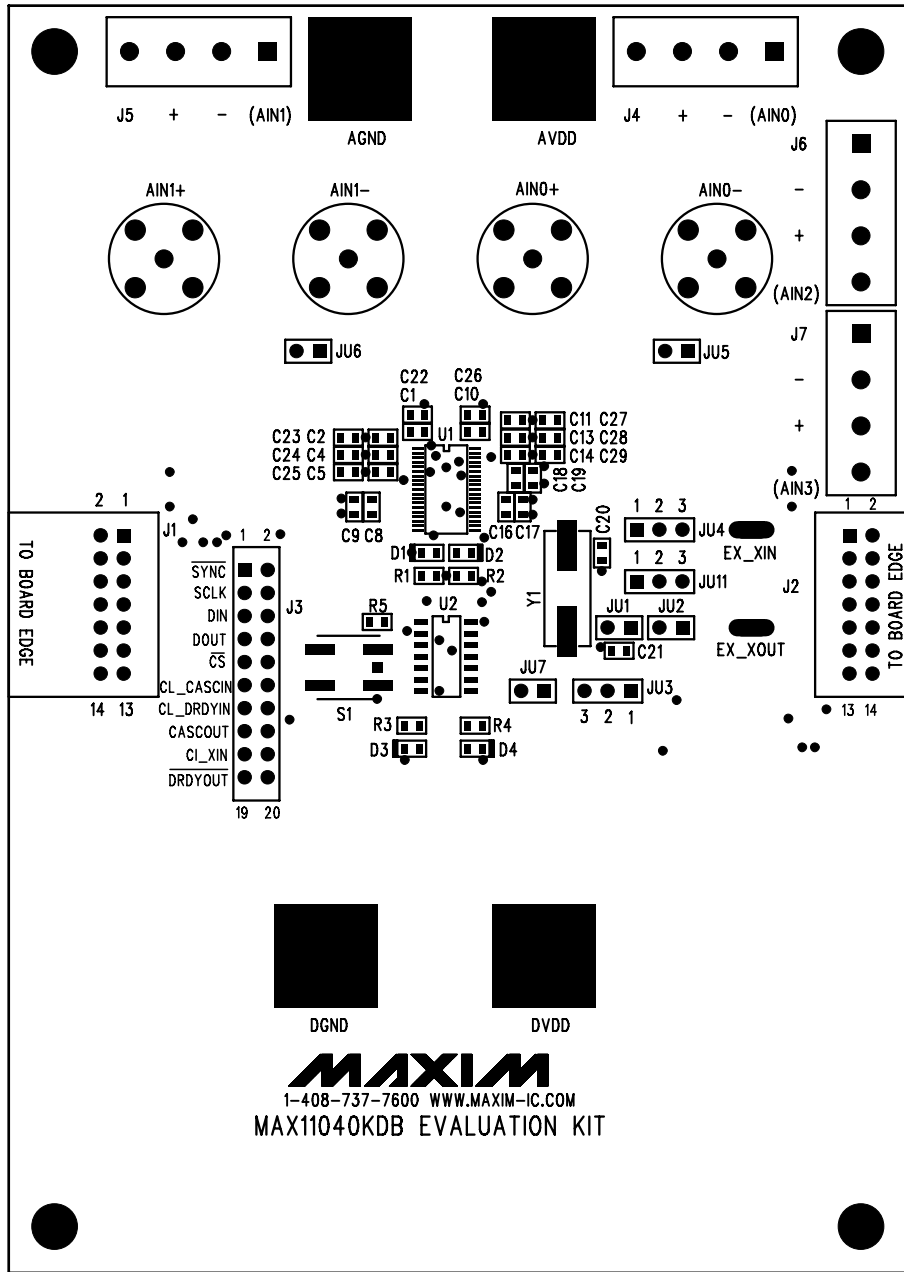

Figure 12. MAX11040K Daughterboard Component Placement Guide—Top

MAX11040K Evaluation Kit/Daughterboard

Evaluate: MAX11040K

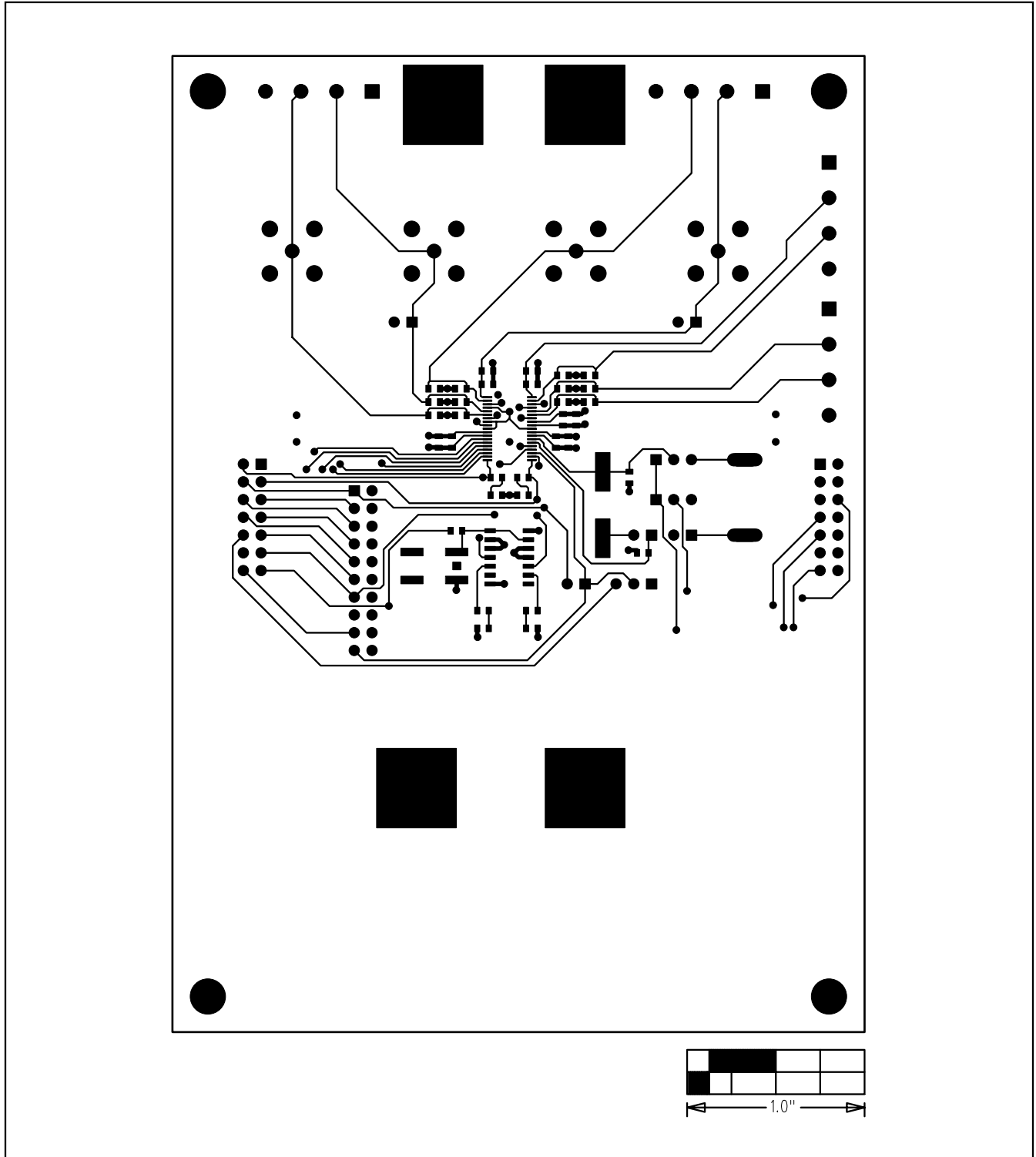

Figure 13. MAX11040K Daughterboard PCB Layout—Component Side

MAX11040K Evaluation Kit/Daughterboard

Evaluate: MAX11040K

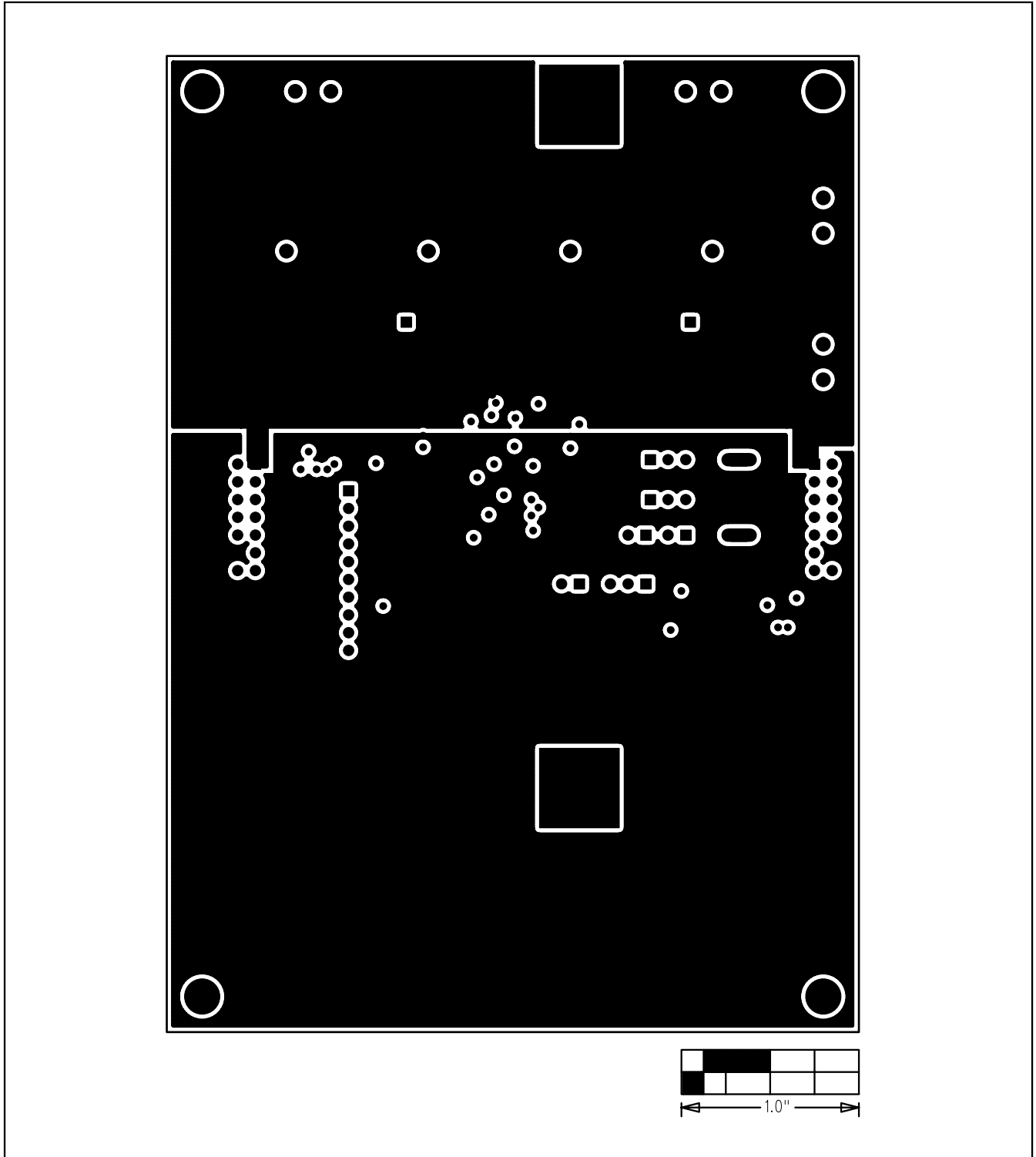

Figure 14. MAX11040K Daughterboard PCB Layout—Layer 2

MAX11040K Evaluation Kit/Daughterboard

Evaluate: MAX11040K

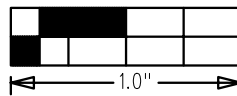
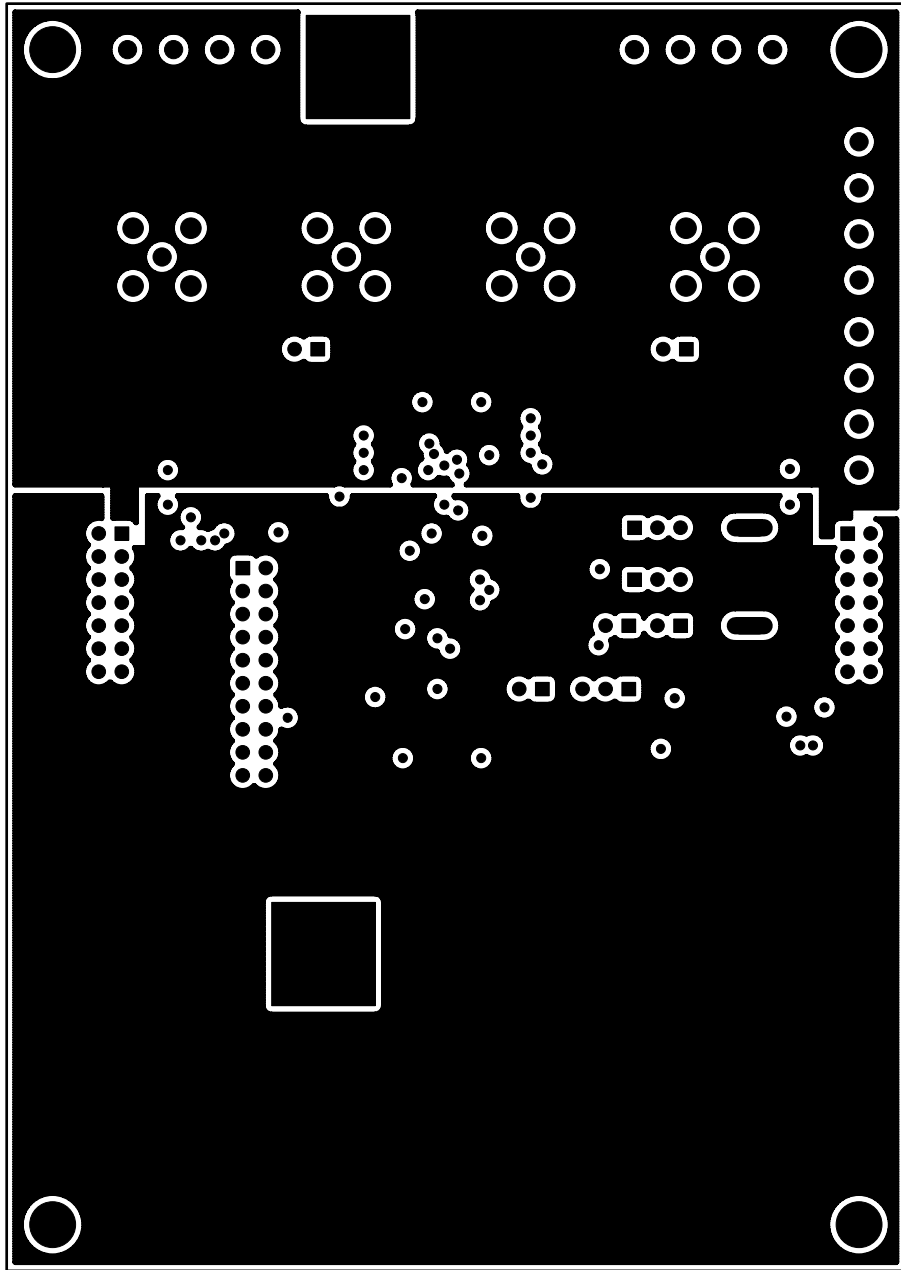

Figure 15. MAX11040K Daughterboard PCB Layout—Layer 3

MAX11040K Evaluation Kit/Daughterboard

Evaluate: MAX11040K

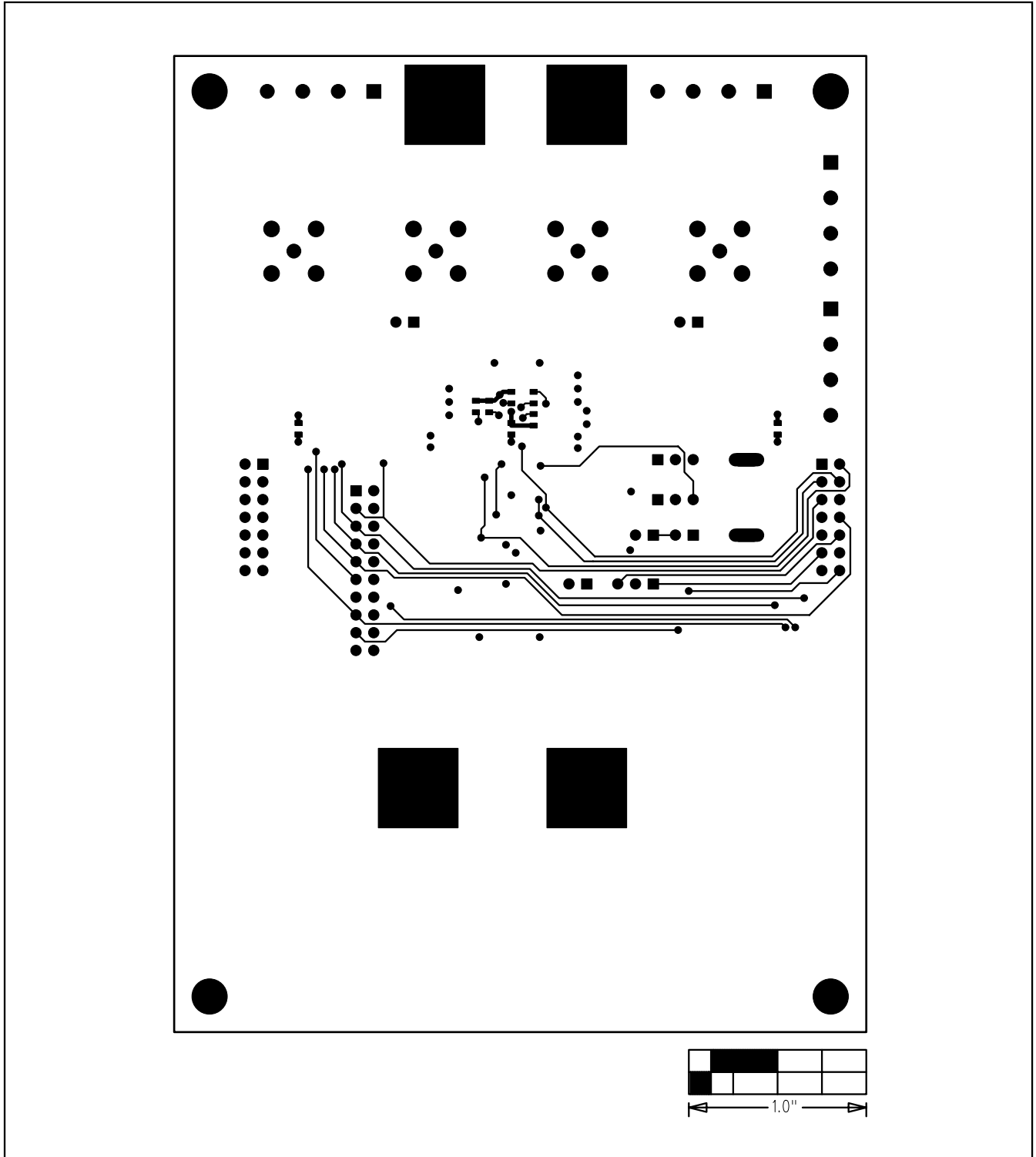

Figure 16. MAX11040K Daughterboard PCB Layout—Bottom

MAX11040K Evaluation Kit/Daughterboard

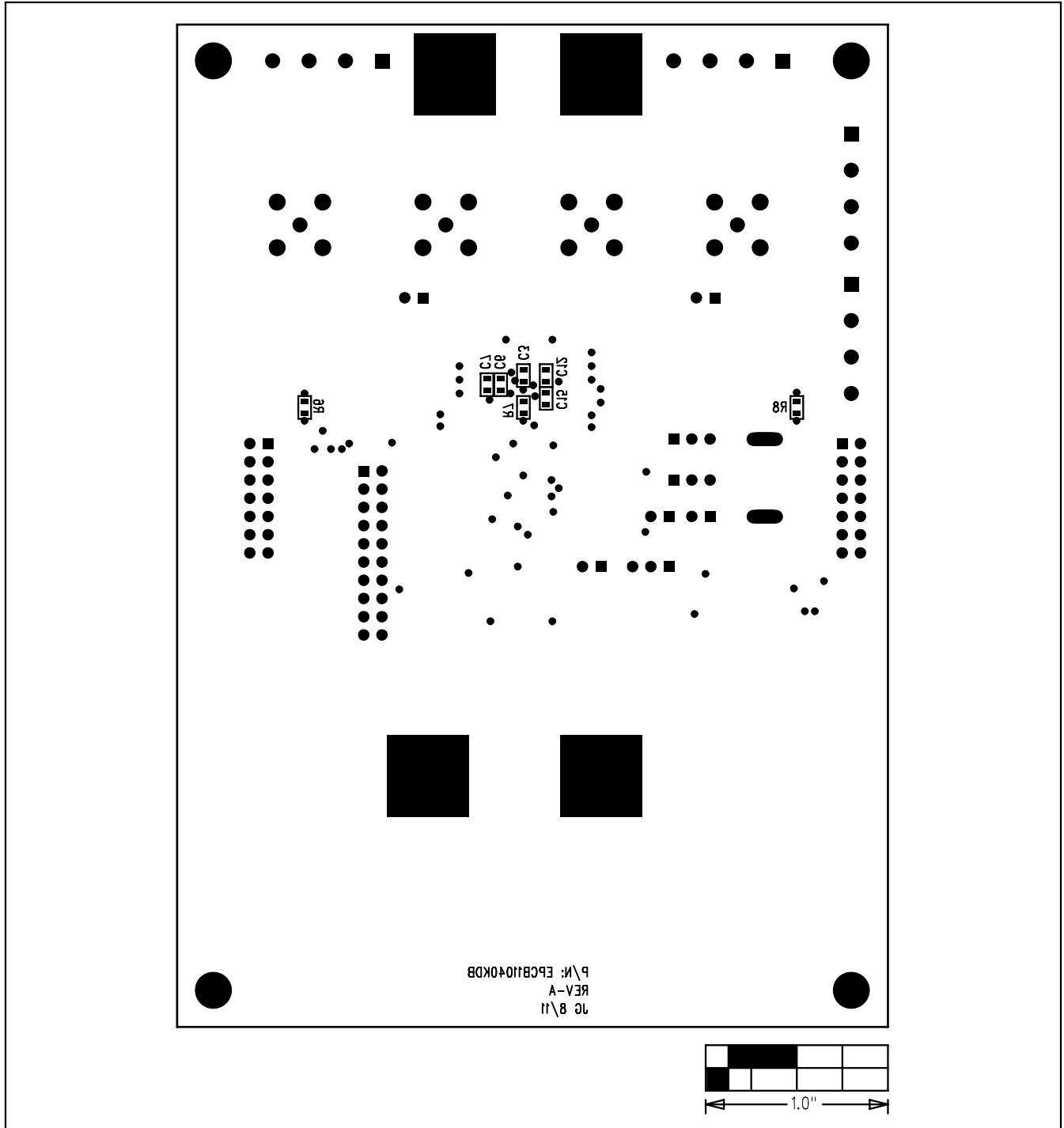

Figure 17. MAX11040K Daughterboard Component Placement Guide—Bottom

MAX11040K Evaluation Kit/Daughterboard

Ordering Information

PART	TYPE
MAX11040KEVKIT#	EV Kit
MAX11040KDBEVKIT#	Daughterboard

#Denotes RoHS compliant.

Evaluate: MAX11040K

MAX11040K Evaluation Kit/Daughterboard

Revision History

REVISION NUMBER	REVISION DATE	DESCRIPTION	PAGES CHANGED
0	11/11	Initial release	—

Maxim cannot assume responsibility for use of any circuitry other than circuitry entirely embodied in a Maxim product. No circuit patent licenses are implied. Maxim reserves the right to change the circuitry and specifications without notice at any time.

32 _____ **Maxim Integrated Products, 120 San Gabriel Drive, Sunnyvale, CA 94086 408-737-7600**

Mouser Electronics

Authorized Distributor

Click to View Pricing, Inventory, Delivery & Lifecycle Information:

[Maxim Integrated:](#)

[MAX11040KDBEVKIT#](#) [MAX11040KEVKIT#](#)