

NTUD3171PZ

Small Signal MOSFET

-20 V, -200 mA, Dual P-Channel, 1.0 x 1.0 mm SOT-963 Package



ON Semiconductor®

<http://onsemi.com>

Features

- Dual P-Channel MOSFET
- Offers a Low $R_{DS(on)}$ Solution in the Ultra Small 1.0 x 1.0 mm Package
- 1.5 V Gate Voltage Rating
- Ultra Thin Profile (< 0.5 mm) Allows It to Fit Easily into Extremely Thin Environments such as Portable Electronics.
- This is a Pb-Free Device

Applications

- High Side Switch
- High Speed Interfacing
- Optimized for Power Management in Ultra Portable Equipment

MAXIMUM RATINGS ($T_J = 25^\circ\text{C}$ unless otherwise specified)

Parameter		Symbol	Value	Unit
Drain-to-Source Voltage		V_{DSS}	-20	V
Gate-to-Source Voltage		V_{GS}	± 8	V
Continuous Drain Current (Note 1)	Steady State	$T_A = 25^\circ\text{C}$	-200	mA
			$T_A = 85^\circ\text{C}$	
	$t \leq 5$ s	$T_A = 25^\circ\text{C}$	-250	
Power Dissipation (Note 1)	Steady State	$T_A = 25^\circ\text{C}$	-125	mW
	$t \leq 5$ s		-200	
Pulsed Drain Current		$t_p = 10 \mu\text{s}$	I_{DM}	-600 mA
Operating Junction and Storage Temperature		T_J, T_{STG}	-55 to 150	$^\circ\text{C}$
Source Current (Body Diode) (Note 2)		I_S	-200	mA
Lead Temperature for Soldering Purposes (1/8" from case for 10 s)		T_L	260	$^\circ\text{C}$

Stresses exceeding Maximum Ratings may damage the device. Maximum Ratings are stress ratings only. Functional operation above the Recommended Operating Conditions is not implied. Extended exposure to stresses above the Recommended Operating Conditions may affect device reliability.

1. Surface-mounted on FR4 board using the minimum recommended pad size, 1 oz Cu.

2. Pulse Test: pulse width $\leq 300 \mu\text{s}$, duty cycle $\leq 2\%$

$V_{(BR)DSS}$	$R_{DS(ON)}$ MAX	I_D Max
-20 V	5.0 Ω @ -4.5 V	-0.2 A
	6.0 Ω @ -2.5 V	
	7.0 Ω @ -1.8 V	
	10 Ω @ -1.5 V	

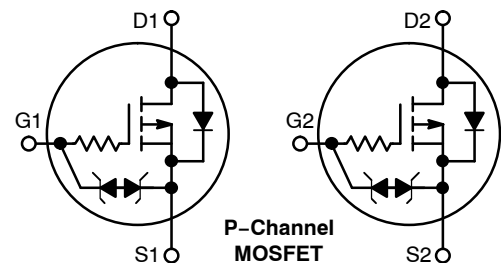

PINOUT: SOT-963

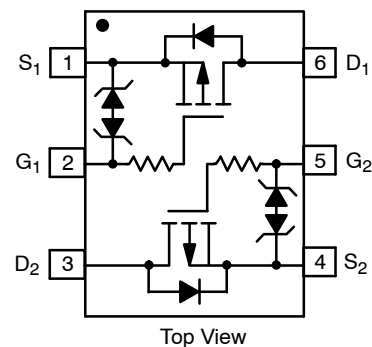

Top View



SOT-963
CASE 527AD

MARKING DIAGRAM

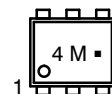

- 4 = Specific Device Code
- M = Date Code
- = Pb-Free Package

ORDERING INFORMATION

See detailed ordering and shipping information in the package dimensions section on page 2 of this data sheet.

NTUD3171PZ

THERMAL RESISTANCE RATINGS

Parameter	Symbol	Max	Unit
Junction-to-Ambient – Steady State (Note 3)	$R_{\theta JA}$	1000	°C/W
Junction-to-Ambient – $t = 5$ s (Note 3)		600	

3. Surface-mounted on FR4 board using the minimum recommended pad size, 1 oz Cu.

ELECTRICAL CHARACTERISTICS ($T_J = 25^\circ\text{C}$ unless otherwise specified)

Parameter	Symbol	Test Condition	Min	Typ	Max	Unit
OFF CHARACTERISTICS						
Drain-to-Source Breakdown Voltage	$V_{(BR)DSS}$	$V_{GS} = 0\text{ V}, I_D = -250\ \mu\text{A}$	-20			V
Zero Gate Voltage Drain Current	I_{DSS}	$V_{GS} = 0\text{ V}, V_{DS} = -5.0\text{ V}$ $T_J = 25^\circ\text{C}$			-50	nA
		$V_{GS} = 0\text{ V}, V_{DS} = -5.0\text{ V}$ $T_J = 85^\circ\text{C}$			-100	
		$V_{GS} = 0\text{ V}, V_{DS} = -16\text{ V}$ $T_J = 25^\circ\text{C}$			-200	
Gate-to-Source Leakage Current	I_{GSS}	$V_{DS} = 0\text{ V}, V_{GS} = \pm 5.0\text{ V}$			± 100	nA

ON CHARACTERISTICS (Note 4)

Gate Threshold Voltage	$V_{GS(TH)}$	$V_{GS} = V_{DS}, I_D = -250\ \mu\text{A}$	-0.4		-1.0	V
Drain-to-Source On Resistance	$R_{DS(ON)}$	$V_{GS} = -4.5\text{ V}, I_D = -100\text{ mA}$		2.0	5.0	Ω
		$V_{GS} = -2.5\text{ V}, I_D = -50\text{ mA}$		2.6	6.0	
		$V_{GS} = -1.8\text{ V}, I_D = -20\text{ mA}$		3.4	7.0	
		$V_{GS} = -1.5\text{ V}, I_D = -10\text{ mA}$		4.0	10	
		$V_{GS} = -1.2\text{ V}, I_D = -1.0\text{ mA}$		6.0		
Forward Transconductance	g_{FS}	$V_{DS} = -5.0\text{ V}, I_D = -125\text{ mA}$		0.35		S
Source-Drain Diode Voltage	V_{SD}	$V_{GS} = 0\text{ V}, I_S = -10\text{ mA}$		-0.6	-1.0	V

CHARGES, CAPACITANCES AND GATE RESISTANCE

Input Capacitance	C_{ISS}	$f = 1\text{ MHz}, V_{GS} = 0\text{ V}$ $V_{DS} = -15\text{ V}$		13.5		pF
Output Capacitance	C_{OSS}			3.8		
Reverse Transfer Capacitance	C_{RSS}			2.0		

SWITCHING CHARACTERISTICS, $V_{GS} = 4.5\text{ V}$ (Note 4)

Turn-On Delay Time	$t_{d(ON)}$	$V_{GS} = -4.5\text{ V}, V_{DD} = -15\text{ V},$ $I_D = -200\text{ mA}, R_G = 2.0\ \Omega$		26		ns
Rise Time	t_r			46		
Turn-Off Delay Time	$t_{d(OFF)}$			196		
Fall Time	t_f			145		

4. Switching characteristics are independent of operating junction temperatures

ORDERING INFORMATION

Device	Package	Shipping [†]
NTUD3171PZT5G	SOT-963 (Pb-Free)	8000 / Tape & Reel

[†]For information on tape and reel specifications, including part orientation and tape sizes, please refer to our Tape and Reel Packaging Specifications Brochure, BRD8011/D.

TYPICAL CHARACTERISTICS

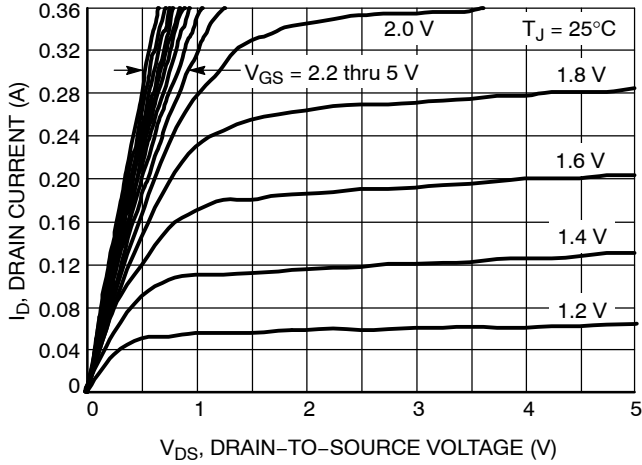

Figure 1. On-Region Characteristics

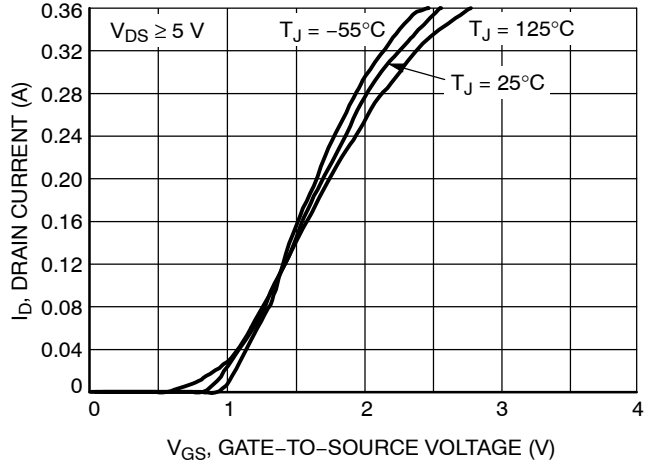

Figure 2. Transfer Characteristics

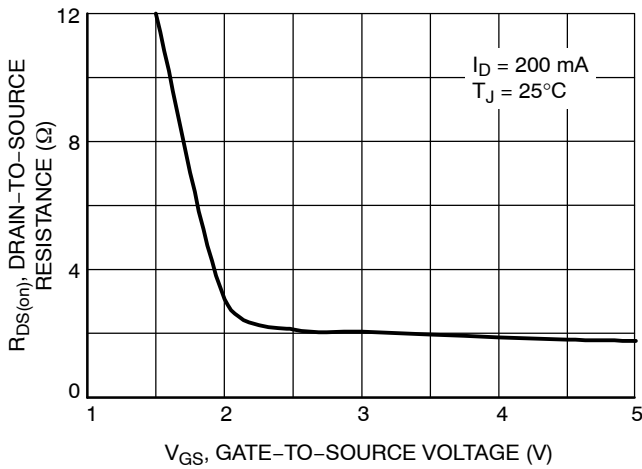

Figure 3. On-Resistance vs. Gate Voltage

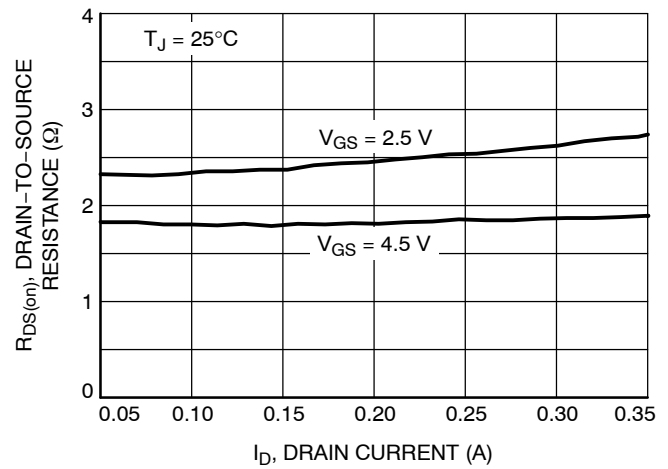

Figure 4. On-Resistance vs. Drain Current and Gate Voltage

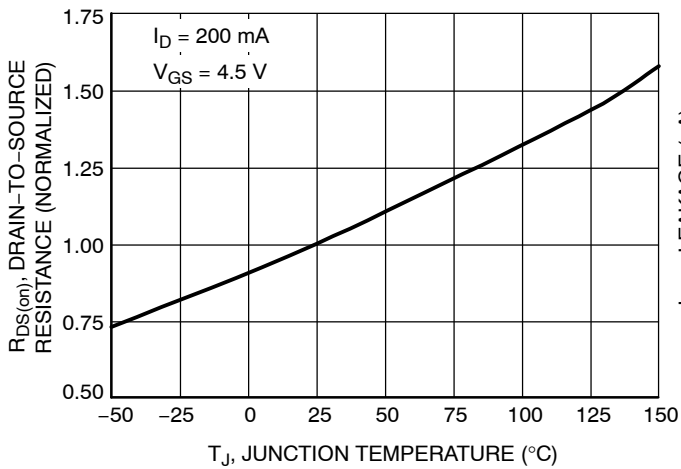

Figure 5. On-Resistance Variation with Temperature

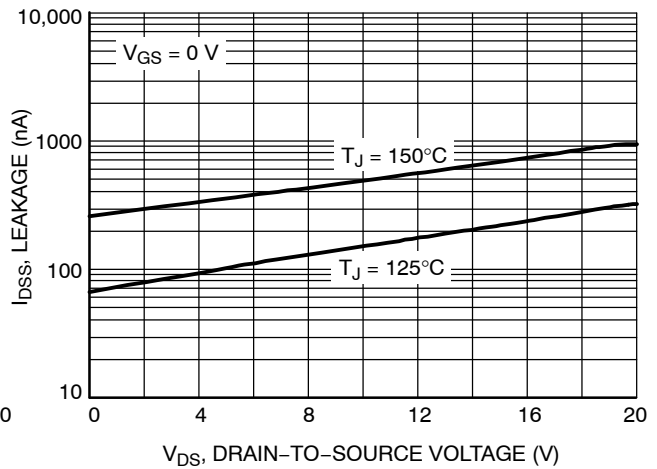

Figure 6. Drain-to-Source Leakage Current vs. Voltage

NTUD3171PZ

TYPICAL CHARACTERISTICS

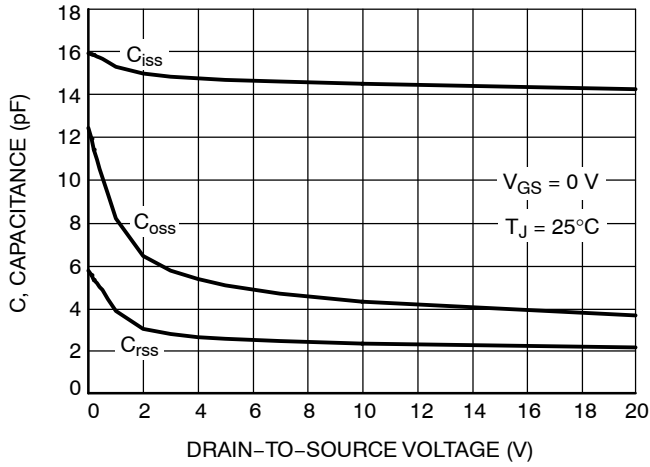

Figure 7. Capacitance Variation

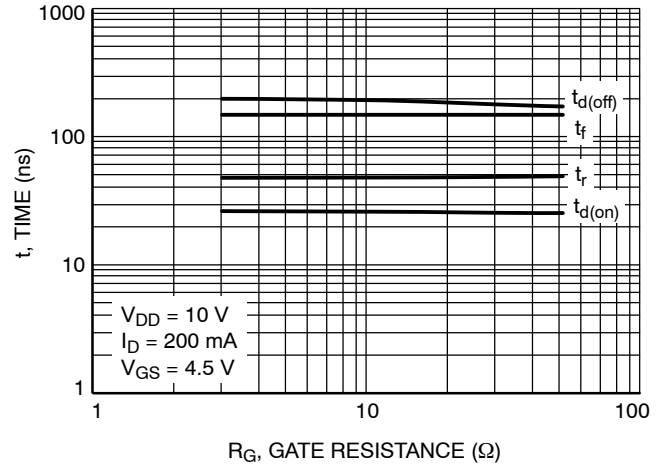

Figure 8. Resistive Switching Time Variation vs. Gate Resistance

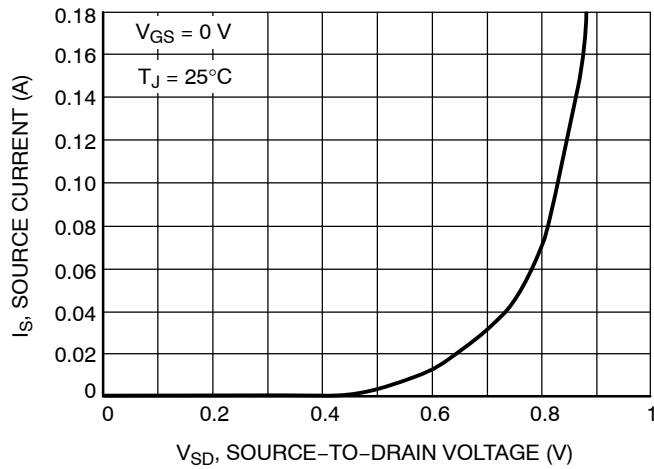

Figure 9. Diode Forward Voltage vs. Current

MECHANICAL CASE OUTLINE

PACKAGE DIMENSIONS

ON Semiconductor®



SCALE 4:1

SOT-963
CASE 527AD-01
ISSUE E

DATE 09 FEB 2010

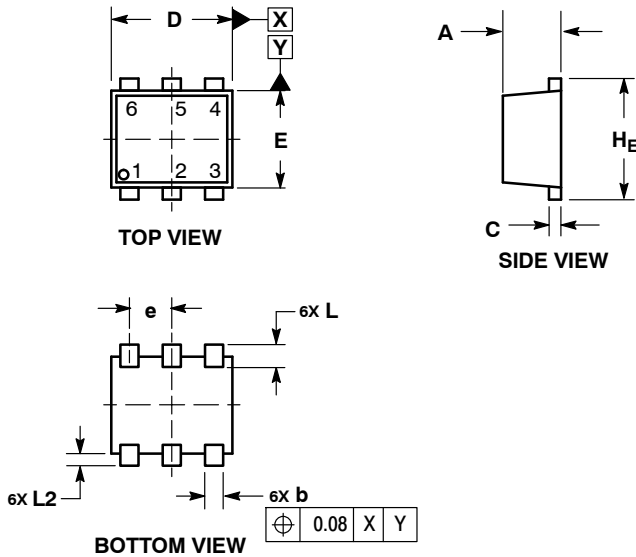

NOTES:

- DIMENSIONING AND TOLERANCING PER ASME Y14.5M, 1994.
- CONTROLLING DIMENSION: MILLIMETERS
- MAXIMUM LEAD THICKNESS INCLUDES LEAD FINISH THICKNESS. MINIMUM LEAD THICKNESS IS THE MINIMUM THICKNESS OF BASE MATERIAL.
- DIMENSIONS D AND E DO NOT INCLUDE MOLD FLASH, PROTRUSIONS, OR GATE BURRS.

MILLIMETERS			
DIM	MIN	NOM	MAX
A	0.34	0.37	0.40
b	0.10	0.15	0.20
C	0.07	0.12	0.17
D	0.95	1.00	1.05
E	0.75	0.80	0.85
e	0.35 BSC		
H _E	0.95	1.00	1.05
L	0.19 REF		
L2	0.05	0.10	0.15

GENERIC MARKING DIAGRAM*

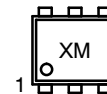

X = Specific Device Code
M = Month Code

*This information is generic. Please refer to device data sheet for actual part marking.
Pb-Free indicator, "G" or microdot "▪", may or may not be present.

RECOMMENDED MOUNTING FOOTPRINT

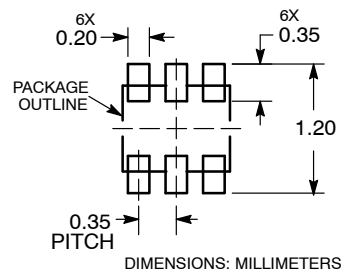

- STYLE 1:**
PIN 1. EMITTER 1
2. BASE 1
3. COLLECTOR 2
4. EMITTER 2
5. BASE 2
6. COLLECTOR 1
- STYLE 2:**
PIN 1. EMITTER 1
2. EMITTER2
3. BASE 2
4. COLLECTOR 2
5. BASE 1
6. COLLECTOR 1
- STYLE 3:**
PIN 1. CATHODE 1
2. CATHODE 1
3. ANODE/ANODE 2
4. CATHODE 2
5. CATHODE 2
6. ANODE/ANODE 1
- STYLE 4:**
PIN 1. COLLECTOR
2. COLLECTOR
3. BASE
4. EMITTER
5. COLLECTOR
6. COLLECTOR
- STYLE 5:**
PIN 1. CATHODE
2. CATHODE
3. ANODE
4. ANODE
5. CATHODE
6. CATHODE
- STYLE 6:**
PIN 1. CATHODE
2. ANODE
3. CATHODE
4. CATHODE
5. CATHODE
6. CATHODE
- STYLE 7:**
PIN 1. CATHODE
2. ANODE
3. CATHODE
4. CATHODE
5. ANODE
6. CATHODE
- STYLE 8:**
PIN 1. DRAIN
2. DRAIN
3. GATE
4. SOURCE3
5. DRAIN
6. DRAIN
- STYLE 9:**
PIN 1. SOURCE 1
2. GATE 1
3. DRAIN 2
4. SOURCE 2
5. GATE 2
6. DRAIN 1
- STYLE 10:**
PIN 1. CATHODE 1
2. N/C
3. CATHODE 2
4. ANODE 2
5. N/C
6. ANODE 1

DOCUMENT NUMBER:	98AON26456D	Electronic versions are uncontrolled except when accessed directly from the Document Repository. Printed versions are uncontrolled except when stamped "CONTROLLED COPY" in red.
DESCRIPTION:	SOT-963, 1X1, 0.35P	PAGE 1 OF 1

ON Semiconductor and are trademarks of Semiconductor Components Industries, LLC dba ON Semiconductor or its subsidiaries in the United States and/or other countries. ON Semiconductor reserves the right to make changes without further notice to any products herein. ON Semiconductor makes no warranty, representation or guarantee regarding the suitability of its products for any particular purpose, nor does ON Semiconductor assume any liability arising out of the application or use of any product or circuit, and specifically disclaims any and all liability, including without limitation special, consequential or incidental damages. ON Semiconductor does not convey any license under its patent rights nor the rights of others.

ON Semiconductor and  are trademarks of Semiconductor Components Industries, LLC dba ON Semiconductor or its subsidiaries in the United States and/or other countries. ON Semiconductor owns the rights to a number of patents, trademarks, copyrights, trade secrets, and other intellectual property. A listing of ON Semiconductor's product/patent coverage may be accessed at www.onsemi.com/site/pdf/Patent-Marking.pdf. ON Semiconductor reserves the right to make changes without further notice to any products herein. ON Semiconductor makes no warranty, representation or guarantee regarding the suitability of its products for any particular purpose, nor does ON Semiconductor assume any liability arising out of the application or use of any product or circuit, and specifically disclaims any and all liability, including without limitation special, consequential or incidental damages. Buyer is responsible for its products and applications using ON Semiconductor products, including compliance with all laws, regulations and safety requirements or standards, regardless of any support or applications information provided by ON Semiconductor. "Typical" parameters which may be provided in ON Semiconductor data sheets and/or specifications can and do vary in different applications and actual performance may vary over time. All operating parameters, including "Typicals" must be validated for each customer application by customer's technical experts. ON Semiconductor does not convey any license under its patent rights nor the rights of others. ON Semiconductor products are not designed, intended, or authorized for use as a critical component in life support systems or any FDA Class 3 medical devices or medical devices with a same or similar classification in a foreign jurisdiction or any devices intended for implantation in the human body. Should Buyer purchase or use ON Semiconductor products for any such unintended or unauthorized application, Buyer shall indemnify and hold ON Semiconductor and its officers, employees, subsidiaries, affiliates, and distributors harmless against all claims, costs, damages, and expenses, and reasonable attorney fees arising out of, directly or indirectly, any claim of personal injury or death associated with such unintended or unauthorized use, even if such claim alleges that ON Semiconductor was negligent regarding the design or manufacture of the part. ON Semiconductor is an Equal Opportunity/Affirmative Action Employer. This literature is subject to all applicable copyright laws and is not for resale in any manner.

PUBLICATION ORDERING INFORMATION

LITERATURE FULFILLMENT:

Email Requests to: orderlit@onsemi.com

ON Semiconductor Website: www.onsemi.com

TECHNICAL SUPPORT

North American Technical Support:
Voice Mail: 1 800-282-9855 Toll Free USA/Canada
Phone: 011 421 33 790 2910

Europe, Middle East and Africa Technical Support:

Phone: 00421 33 790 2910

For additional information, please contact your local Sales Representative