

ISL9014

Dual LDO with Low Noise, Low I_Q and High PSRR

FN9245
Rev 3.00
March 11, 2008

ISL9014 is a high performance dual LDO capable of sourcing 300mA current from both outputs. The device has a low standby current and high-PSRR and is stable with output capacitance of 1μF to 10μF with ESR of up to 200mΩ.

A reference bypass pin allows an external capacitor for adjusting a noise filter for low noise and high PSRR applications.

The quiescent current is typically only 45μA with both LDOs enabled and active. Separate enable pins control each individual LDO output. When both enable pins are low, the device is in shutdown, typically drawing less than 0.1μA.

Several combinations of voltage outputs are standard. Output voltage options for each LDO range from 1.5V to 3.3V. Other output voltage options may be available upon request.

Pinout

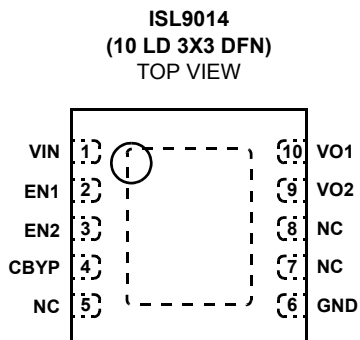

Features

- Integrates two high performance LDOs
 - VO1 - 300mA output
 - VO2 - 300mA output
- Excellent transient response to large current steps
- Excellent load regulation: <1% voltage change across full range of load current
- High PSRR: 70dB @ 1kHz
- Wide input voltage capability: 2.3V to 6.5V
- Extremely low quiescent current: 45μA (both LDOs active)
- Low dropout voltage: typically 200mV @ 300mA
- Low output noise: typically 30μV_{RMS} @ 100μA (1.5V)
- Stable with 1μF to 10μF ceramic capacitors
- Separate enable pins for each LDO
- Soft-start to limit input current surge during enable
- Current limit and overheat protection
- ±1.8% accuracy over all operating conditions
- Tiny 10 Ld 3mmx3mm DFN package
- -40°C to +85°C operating temperature range
- Pin compatible with Micrel MIC2211
- Pb-free (RoHS compliant)

Applications

- PDAs, Cell Phones and Smart Phones
- Portable Instruments, MP3 Players
- Handheld Devices including Medical Handhelds

Ordering Information

PART NUMBER (Notes 1, 2, 3)	PART MARKING	VO1 VOLTAGE	VO2 VOLTAGE	TEMP RANGE (°C)	PACKAGE (Pb-Free)	PKG. DWG. #
ISL9014IRNNZ	DCBS	3.3V	3.3V	-40 to +85	10 Ld 3x3 DFN	L10.3x3C
ISL9014IRNJZ	DBBK	3.3V	2.8V	-40 to +85	10 Ld 3x3 DFN	L10.3x3C
ISL9014IRNFZ	DBBL	3.3V	2.5V	-40 to +85	10 Ld 3x3 DFN	L10.3x3C
ISL9014IRNCZ	DCBT	3.3V	1.8V	-40 to +85	10 Ld 3x3 DFN	L10.3x3C
ISL9014IRMNZ	DCBV	3.0V	3.3V	-40 to +85	10 Ld 3x3 DFN	L10.3x3C
ISL9014IRMMZ	DBBV	3.0V	3.0V	-40 to +85	10 Ld 3x3 DFN	L10.3x3C
ISL9014IRMGZ	DCCC	3.0V	2.7V	-40 to +85	10 Ld 3x3 DFN	L10.3x3C
ISL9014IRLLZ	DCEA	2.9V	2.9V	-40 to +85	10 Ld 3x3 DFN	L10.3x3C
ISL9014IRKNZ	DCCG	2.85V	3.3V	-40 to +85	10 Ld 3x3 DFN	L10.3x3C
ISL9014IRKKZ	DBBW	2.85V	2.85V	-40 to +85	10 Ld 3x3 DFN	L10.3x3C
ISL9014IRKJZ	DCFA	2.85V	2.8V	-40 to +85	10 Ld 3x3 DFN	L10.3x3C
ISL9014IRKFZ	DBBM	2.85V	2.5V	-40 to +85	10 Ld 3x3 DFN	L10.3x3C
ISL9014IRKPZ	DDJA	2.85V	1.85V	-40 to +85	10 Ld 3x3 DFN	L10.3x3C
ISL9014IRKCZ	DCBA	2.85V	1.8V	-40 to +85	10 Ld 3x3 DFN	L10.3x3C
ISL9014IRJNZ	DCCH	2.8V	3.3V	-40 to +85	10 Ld 3x3 DFN	L10.3x3C
ISL9014IRJMZ	DBBT	2.8V	3.0V	-40 to +85	10 Ld 3x3 DFN	L10.3x3C
ISL9014IRJRZ	DCDA	2.8V	2.6V	-40 to +85	10 Ld 3x3 DFN	L10.3x3C
ISL9014IRJCZ	DBBP	2.8V	1.8V	-40 to +85	10 Ld 3x3 DFN	L10.3x3C
ISL9014IRJBZ	DCCA	2.8V	1.5V	-40 to +85	10 Ld 3x3 DFN	L10.3x3C
ISL9014IRGPZ	DDBA	2.7V	1.85V	-40 to +85	10 Ld 3x3 DFN	L10.3x3C
ISL9014IRGCZ	DBBR	2.7V	1.8V	-40 to +85	10 Ld 3x3 DFN	L10.3x3C
ISL9014IRFJZ	DBBN	2.5V	2.8V	-40 to +85	10 Ld 3x3 DFN	L10.3x3C
ISL9014IRFDZ	DCCV	2.5V	2.0V	-40 to +85	10 Ld 3x3 DFN	L10.3x3C
ISL9014IRFCZ	DCDB	2.5V	1.8V	-40 to +85	10 Ld 3x3 DFN	L10.3x3C
ISL9014IRPLZ	DBBY	1.85V	2.9V	-40 to +85	10 Ld 3x3 DFN	L10.3x3C
ISL9014IRPPZ	DDCA	1.85V	1.85V	-40 to +85	10 Ld 3x3 DFN	L10.3x3C
ISL9014IRCJZ	DCDH	1.8V	2.8V	-40 to +85	10 Ld 3x3 DFN	L10.3x3C
ISL9014IRCCZ	DCDL	1.8V	1.8V	-40 to +85	10 Ld 3x3 DFN	L10.3x3C
ISL9014IRBLZ	DCDS	1.5V	2.9V	-40 to +85	10 Ld 3x3 DFN	L10.3x3C
ISL9014IRBJZ	DBBS	1.5V	2.8V	-40 to +85	10 Ld 3x3 DFN	L10.3x3C
ISL9014IRBCZ	DCDV	1.5V	1.8V	-40 to +85	10 Ld 3x3 DFN	L10.3x3C
ISL9014IRBBZ	DDFA	1.5V	1.5V	-40 to +85	10 Ld 3x3 DFN	L10.3x3C

NOTES:

1. Add "-T" suffix for tape and reel. Please refer to TB347 for details on reel specifications.
2. For availability and lead time of devices with voltage combinations not listed in the table, contact Intersil Marketing.
3. These Intersil Pb-free plastic packaged products employ special Pb-free material sets; molding compounds/die attach materials and 100% matte tin plate PLUS ANNEAL - e3 termination finish, which is RoHS compliant and compatible with both SnPb and Pb-free soldering operations. Intersil Pb-free products are MSL classified at Pb-free peak reflow temperatures that meet or exceed the Pb-free requirements of IPC/JEDEC J STD-020.

Absolute Maximum Ratings

Supply Voltage (VIN)	+7.1V
V _{O1} , V _{O2} Pins	+3.6V
All Other Pins	-0.3 to (V _{IN} +0.3)V

Recommended Operating Conditions

Ambient Temperature Range (T _A)	-40°C to +85°C
Supply Voltage (VIN)	2.3V to 6.5V

Thermal Information

Thermal Resistance (Notes 4, 5)	θ_{JA} (°C/W)	θ_{JC} (°C/W)
10 Ld 3x3 DFN Package	50	10
Junction Temperature Range	-40°C to +125°C	
Operating Temperature Range	-40°C to +85°C	
Storage Temperature Range	-65°C to +150°C	
Pb-free Reflow Profile	see link below http://www.intersil.com/pbfree/Pb-FreeReflow.asp	

CAUTION: Do not operate at or near the maximum ratings listed for extended periods of time. Exposure to such conditions may adversely impact product reliability and result in failures not covered by warranty.

NOTES:

- θ_{JA} is measured in free air with the component mounted on a high effective thermal conductivity test board with "direct attach" features. See Tech Brief TB379.
- For θ_{JC} , the "case temp" location is the center of the exposed metal pad on the package underside.

Electrical Specifications

Unless otherwise noted, all parameters are guaranteed over the operational supply voltage and temperature range of the device as follows:

T_A = -40°C to +85°C; V_{IN} = (V_O + 1.0V) to 6.5V with a minimum V_{IN} of 2.3V; C_{IN} = 1 μ F; C_O = 1 μ F; C_{BYP} = 0.01 μ F.

PARAMETER	SYMBOL	TEST CONDITIONS	MIN (Note 7)	TYP	MAX (Note 7)	UNITS
DC CHARACTERISTICS						
Supply Voltage	V _{IN}		2.3		6.5	V
Ground Current		Quiescent condition: I _{O1} = 0 μ A; I _{O2} = 0 μ A				
	I _{DD1}	One LDO active		25	40	μ A
	I _{DD2}	Both LDO active		45	60	μ A
Shutdown Current	I _{DDS}	@ +25°C		0.1	1.0	μ A
UVLO Threshold	V _{UV+}		1.9	2.1	2.3	V
	V _{UV-}		1.6	1.8	2.0	V
Regulation Voltage Accuracy		Variation from nominal voltage output, V _{IN} = V _O + 0.5V to 5.5V, T _J = -40°C to +125°C	-1.8		+1.8	%
Line Regulation		V _{IN} = (V _{OUT} + 1.0V relative to highest output voltage) to 5.5V	-0.2	0	0.2	%/V
Load Regulation		I _{OUT} = 100 μ A to 150mA		0.1	0.7	%
		I _{OUT} = 100 μ A to 300mA			1.0	%
Maximum Output Current	I _{MAX}	VO1: Continuous	300			mA
		VO2: Continuous	300			mA
Internal Current Limit	I _{LIM}		350	475	600	mA
Dropout Voltage (Note 6)	V _{DO1}	I _O = 150mA; V _O > 2.1V		125	200	mV
	V _{DO2}	I _O = 300mA; V _O < 2.5V		300	500	mV
	V _{DO3}	I _O = 300mA; 2.5V \leq V _O \leq 2.8V		250	400	mV
	V _{DO4}	I _O = 300mA; V _O > 2.8V		200	325	mV
Thermal Shutdown Temperature	T _{SD+}			145		°C
	T _{SD-}			110		°C
AC CHARACTERISTICS						
Ripple Rejection		I _O = 10mA, V _{IN} = 2.8V(min), V _O = 1.8V, C _{BYP} = 0.1 μ F				
		@ 1kHz		70		dB
		@ 10kHz		55		dB
		@ 100kHz		40		dB

Electrical Specifications

Unless otherwise noted, all parameters are guaranteed over the operational supply voltage and temperature range of the device as follows:

$T_A = -40^{\circ}\text{C}$ to $+85^{\circ}\text{C}$; $V_{IN} = (V_O + 1.0\text{V})$ to 6.5V with a minimum V_{IN} of 2.3V; $C_{IN} = 1\mu\text{F}$; $C_O = 1\mu\text{F}$; $C_{BYP} = 0.01\mu\text{F}$. **(Continued)**

PARAMETER	SYMBOL	TEST CONDITIONS	MIN (Note 7)	TYP	MAX (Note 7)	UNITS
Output Noise Voltage		$I_O = 100\mu\text{A}$, $V_O = 1.5\text{V}$, $T_A = +25^{\circ}\text{C}$, $C_{BYP} = 0.1\mu\text{F}$ BW = 10Hz to 100kHz		30		μV_{RMS}
DEVICE START-UP CHARACTERISTICS						
Device Enable Time	t_{EN}	Time from assertion of the ENx pin to when the output voltage reaches 95% of the $V_O(\text{nom})$		250	500	μs
LDO Soft-Start Ramp Rate	t_{SSR}	Slope of linear portion of LDO output voltage ramp during start-up		30	60	$\mu\text{s}/\text{V}$
EN1, EN2 PIN CHARACTERISTICS						
Input Low Voltage	V_{IL}		-0.3		0.5	V
Input High Voltage	V_{IH}		1.4		$V_{\text{IN}} + 0.3$	V
Input Leakage Current	I_{IL} , I_{IH}				0.1	μA
Pin Capacitance	C_{PIN}	Informative		5		pF

NOTES:

- $V_{\text{Ox}} = 0.98 \cdot V_{\text{Ox}}(\text{NOM})$; Valid for V_{Ox} greater than 1.85V.
- Parts are 100% tested at $+25^{\circ}\text{C}$. Temperature limits established by characterization and are not production tested.

Typical Performance Curves

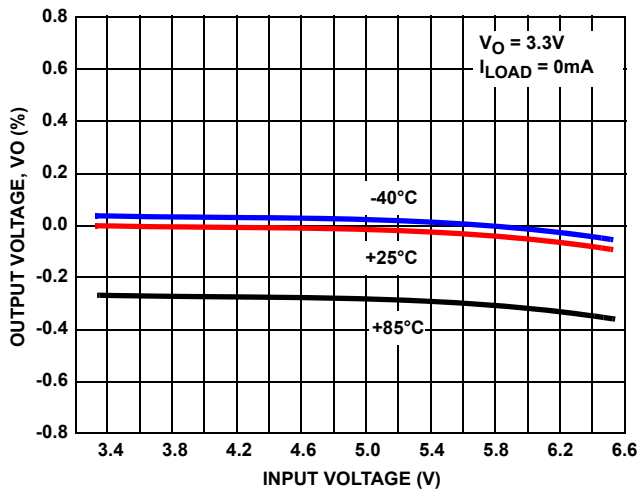

FIGURE 1. OUTPUT VOLTAGE vs INPUT VOLTAGE (3.3V OUTPUT)

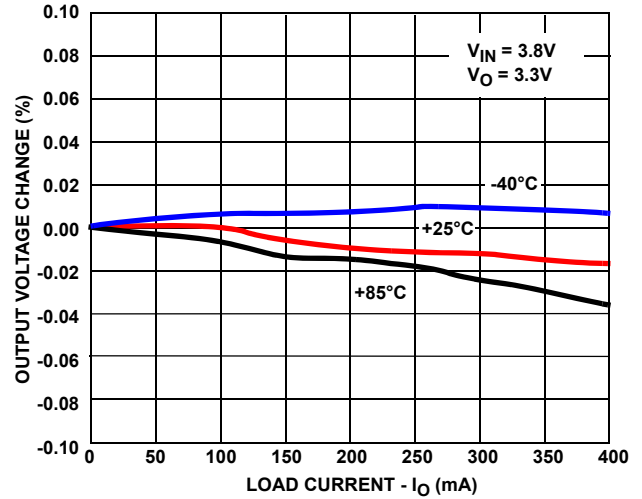

FIGURE 2. OUTPUT VOLTAGE CHANGE vs LOAD CURRENT

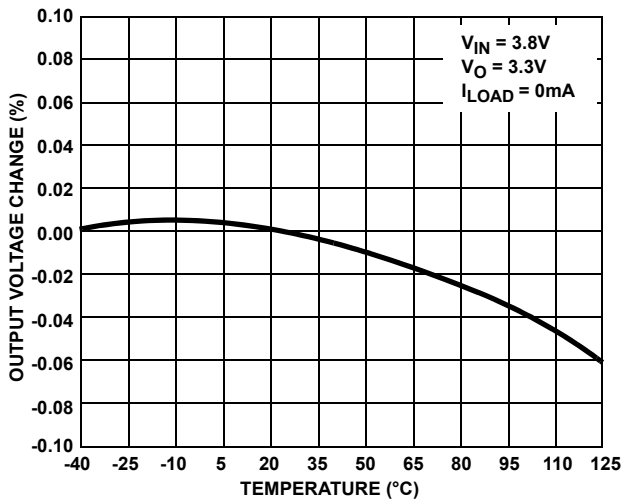

FIGURE 3. OUTPUT VOLTAGE CHANGE vs TEMPERATURE

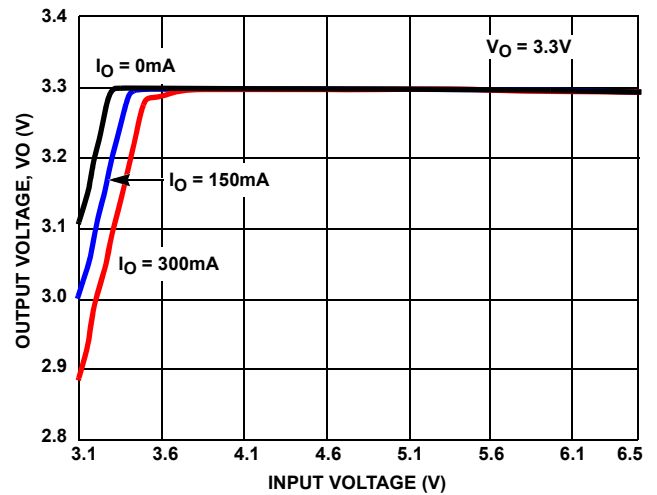

FIGURE 4. OUTPUT VOLTAGE vs INPUT VOLTAGE (3.3V OUTPUT)

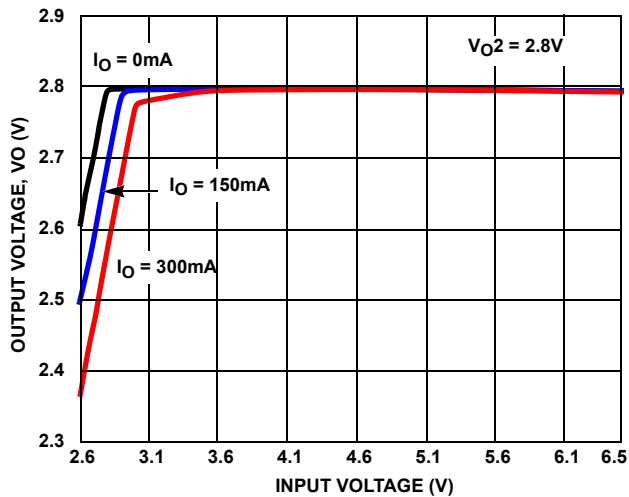

FIGURE 5. OUTPUT VOLTAGE vs INPUT VOLTAGE (VO2 = 2.8V)

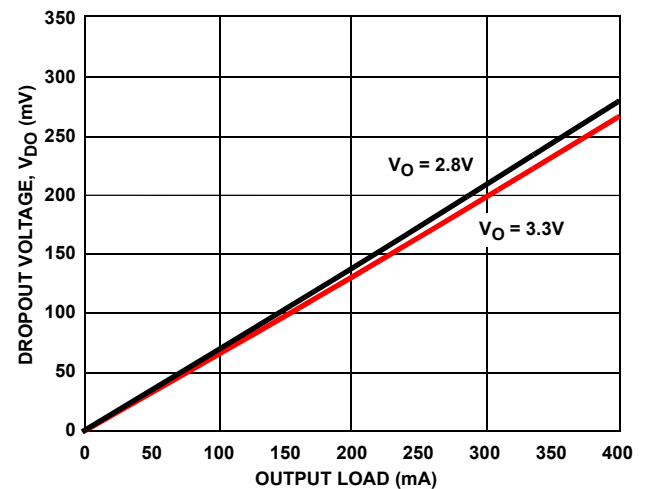

FIGURE 6. DROPOUT VOLTAGE vs LOAD CURRENT

Typical Performance Curves (Continued)

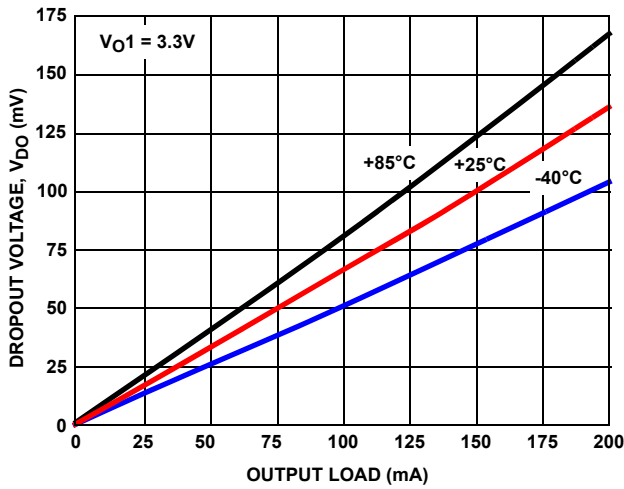

FIGURE 7. VO1 DROPOUT VOLTAGE vs LOAD CURRENT

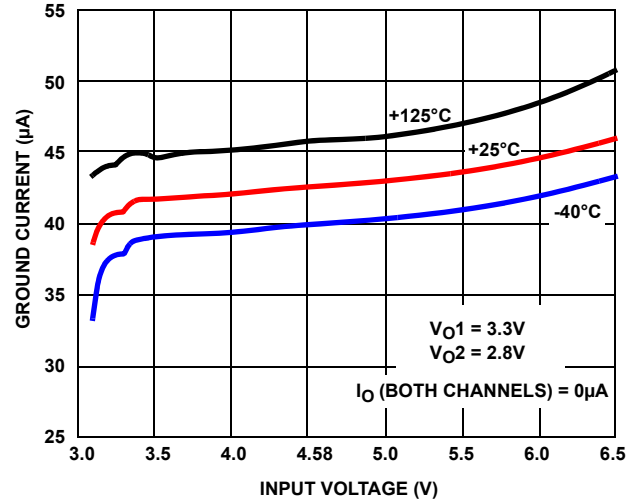

FIGURE 8. GROUND CURRENT vs INPUT VOLTAGE

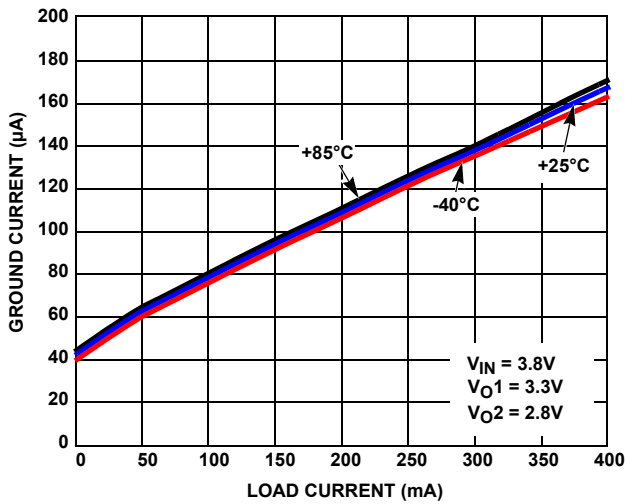

FIGURE 9. GROUND CURRENT vs LOAD

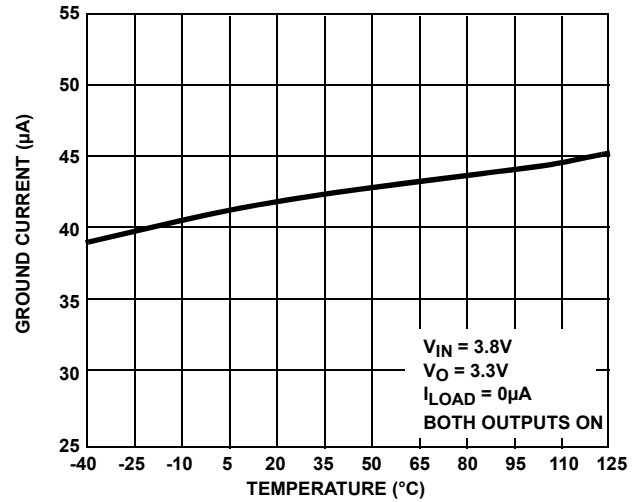

FIGURE 10. GROUND CURRENT vs TEMPERATURE

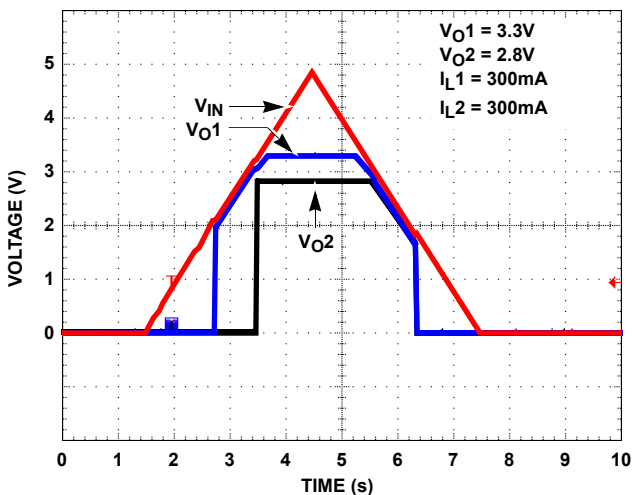

FIGURE 11. POWER-UP/POWER-DOWN

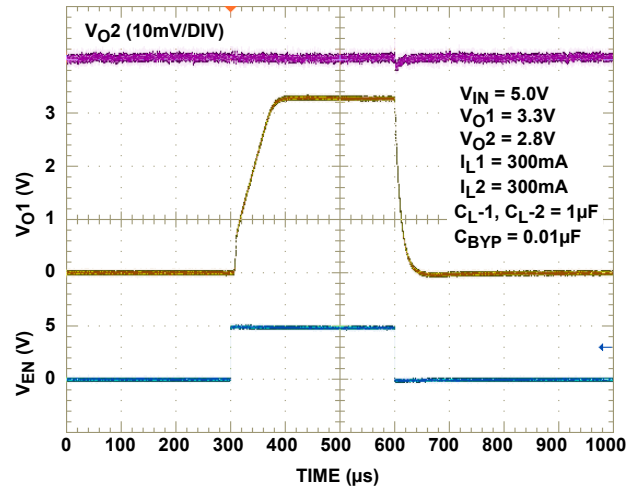

FIGURE 12. TURN-ON/TURN-OFF RESPONSE

Typical Performance Curves (Continued)

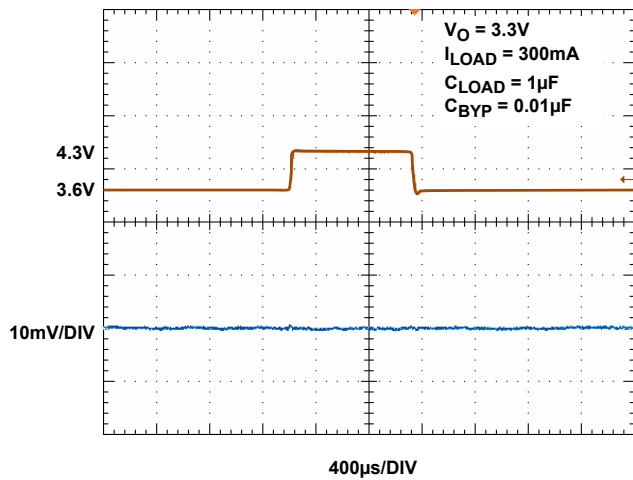

FIGURE 13. LINE TRANSIENT RESPONSE, 3.3V OUTPUT

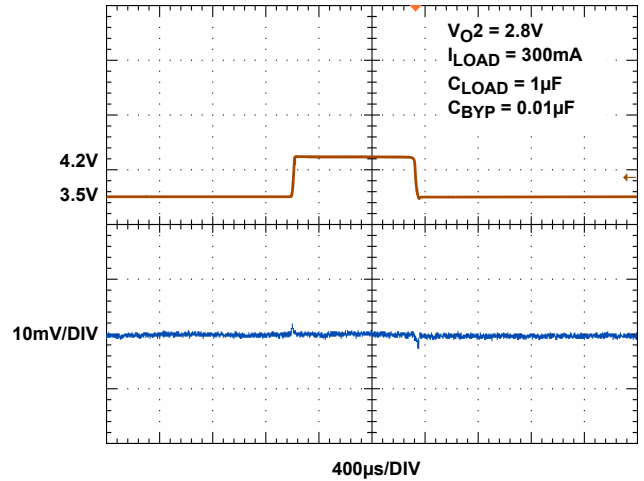

FIGURE 14. LINE TRANSIENT RESPONSE, 2.8V OUTPUT

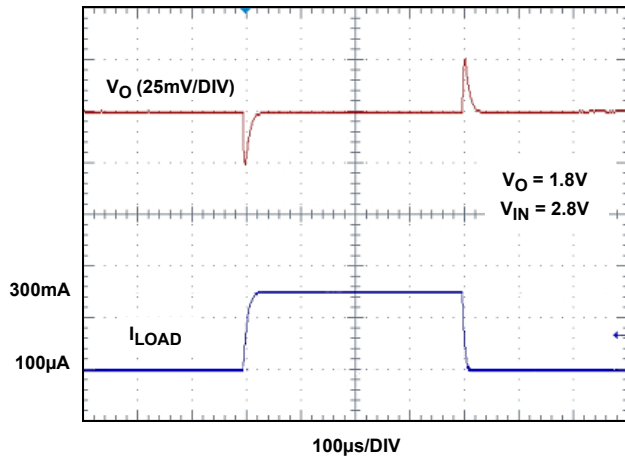

FIGURE 15. LOAD TRANSIENT RESPONSE

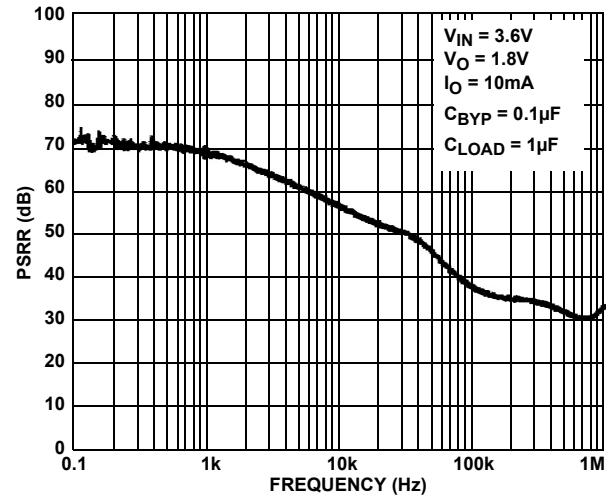

FIGURE 16. PSRR vs FREQUENCY

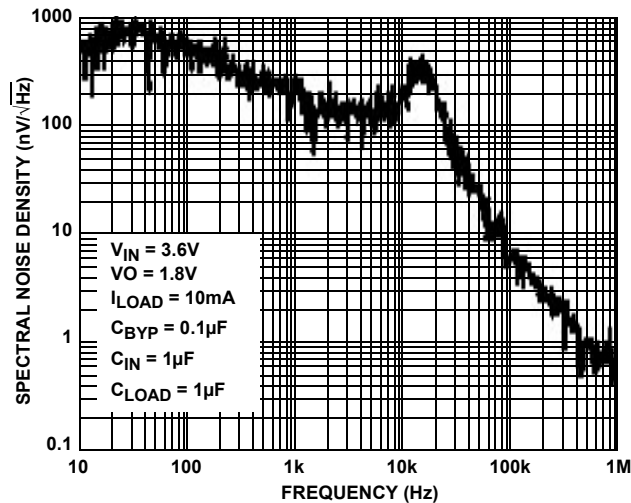
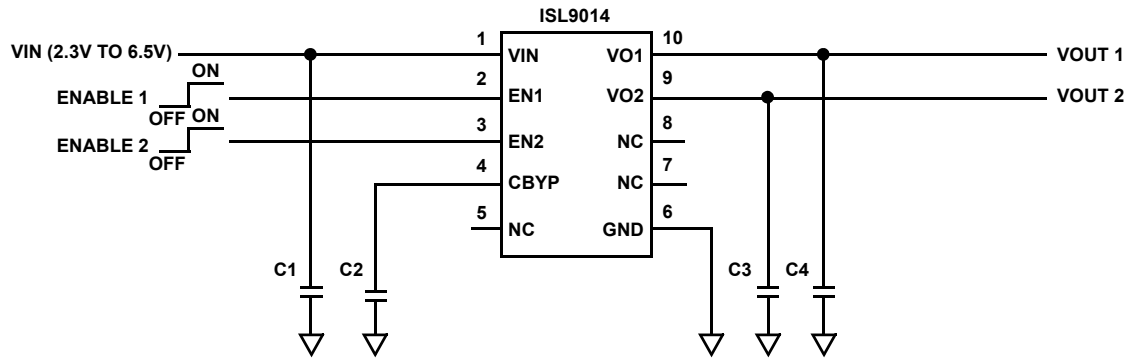

FIGURE 17. SPECTRAL NOISE DENSITY vs FREQUENCY

Pin Description

PIN NUMBER	PIN NAME	TYPE	DESCRIPTION
1	VIN	Analog I/O	Supply Voltage/LDO Input: Connect a 1μF capacitor to GND.
2	EN1	Low Voltage Compatible CMOS Input	LDO-1 Enable.
3	EN2	Low Voltage Compatible CMOS Input	LDO-2 Enable.
4	CBYP	Analog I/O	Reference Bypass Capacitor Pin: Optionally connect capacitor of value 0.01μF to 1μF between this pin and GND to tune in the desired noise and PSRR performance.
5, 7, 8	NC	NC	No Connection
6	GND	Ground	GND is the connection to system ground. Connect to PCB Ground plane.
9	VO2	Analog I/O	LDO-2 Output: Connect capacitor of value 1μF to 10μF to GND (1μF recommended).
10	VO1	Analog I/O	LDO-1 Output: Connect capacitor of value 1μF to 10μF to GND (1μF recommended).

Typical Application



C1, C3, C4: 1μF X5R CERAMIC CAPACITOR
 C2: 0.1μF X5R CERAMIC CAPACITOR

Block Diagram

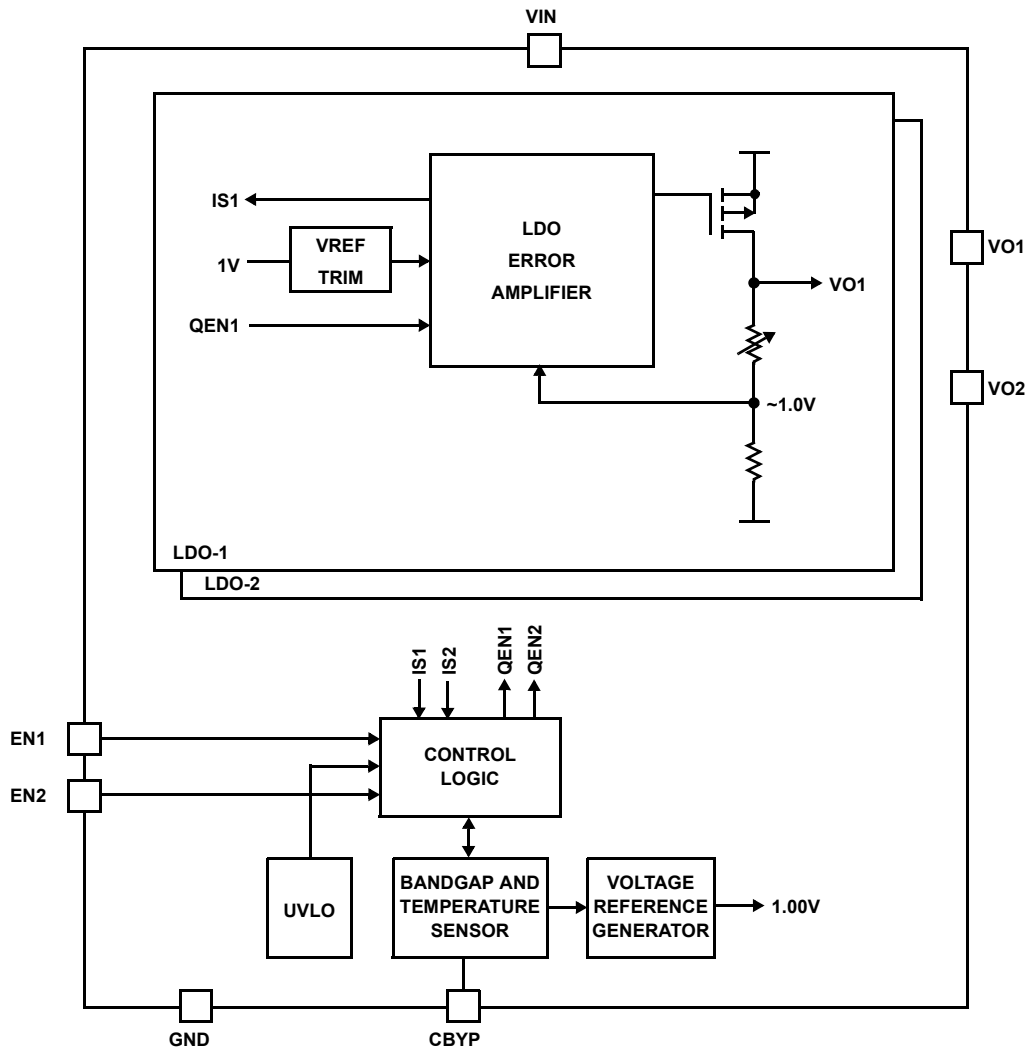

Functional Description

The ISL9014 contains all circuitry required to implement two high performance LDOs. High performance is achieved through a circuit that delivers fast transient response to varying load conditions. In a quiescent condition, the ISL9014 adjusts its biasing to achieve the lowest standby current consumption.

The device also integrates current limit protection, smart thermal shutdown protection, staged turn-on and soft-start. Smart Thermal shutdown protects the device against overheating. Staged turn-on and soft-start minimize start-up input current surges without causing excessive device turn-on time.

Power Control

The ISL9014 has two separate enable pins (EN1 and EN2) to individually control power to each of the LDO outputs. When both EN1 and EN2 are low, the device is in shutdown

mode. During this condition, all on-chip circuits are off, and the device draws minimum current, typically less than $0.1\mu\text{A}$. When one or both of the enable pins are asserted, the device first polls the output of the UVLO detector to ensure that VIN voltage is at least about 2.1V. Once verified, the device initiates a start-up sequence. During the start-up sequence, trim settings are first read and latched. Then, sequentially, the bandgap, reference voltage and current generation circuitry power-up. Once the references are stable, a fast-start circuit quickly charges the external reference bypass capacitor (connected to the CBYP pin) to the proper operating voltage. After the bypass capacitor has been charged, the LDOs power-up.

If EN1 is brought high, and EN2 goes high before the VO1 output stabilizes, the ISL9014 delays the VO2 turn-on until the VO1 output reaches its target level.

If EN2 is brought high, and EN1 goes high before VO2 starts its output ramp, then VO1 turns on first and the ISL9014

delays the VO2 turn-on until the VO1 output reaches its target level.

If EN2 is brought high, and EN1 goes high after VO2 starts its output ramp, then the ISL9014 immediately starts to ramp up the VO1 output.

If both EN1 and EN2 are brought high at the same time, the VO1 output has priority, and is always powered up first.

During operation, whenever the VIN voltage drops below about 1.8V, the ISL9014 immediately disables both LDO outputs. When VIN rises back above 2.1V, the device re-initiates its start-up sequence and LDO operation will resume automatically.

Reference Generation

The reference generation circuitry includes a trimmed bandgap, a trimmed voltage reference divider, a trimmed current reference generator, and an RC noise filter. The filter includes the external capacitor connected to the CBYP pin. A 0.01 μ F capacitor connected CBYP implements a 100Hz lowpass filter, and is recommended for most high performance applications. For the lowest noise application, a 0.1 μ F or greater CBYP capacitor should be used. This filters the reference noise to below the 10Hz to 1kHz frequency band, which is crucial in many noise-sensitive applications.

The bandgap generates a zero temperature coefficient (TC) voltage for the reference divider. The reference divider provides the regulation reference and other voltage references required for current generation and over-temperature detection.

The current generator outputs references required for adaptive biasing as well as references for LDO output current limit and thermal shutdown determination.

LDO Regulation and Programmable Output Divider

The LDO Regulator is implemented with a high-gain operational amplifier driving a PMOS pass transistor. The design of the ISL9014 provides a regulator that has low quiescent current, fast transient response, and overall stability across all operating and load current conditions. LDO stability is guaranteed for a 1 μ F to 10 μ F output capacitor that has a tolerance better than 20% and ESR less than 200m Ω . The design is performance-optimized for a 1 μ F capacitor. Unless limited by the application, use of an output capacitor value above 4.7 μ F is not recommended as LDO performance improvement is minimal.

Soft-start circuitry integrated into each LDO limits the initial ramp-up rate to about 30 μ s/V to minimize current surge. The ISL9014 provides short-circuit protection by limiting the output current to about 475mA.

Each LDO uses an independently trimmed 1V reference. An internal resistor divider drops the LDO output voltage down to 1V. This is compared to the 1V reference for regulation. The resistor division ratio is programmed in the factory.

Overheat Detection

The bandgap outputs a proportional-to-temperature current that is indicative of the temperature of the silicon. This current is compared with references to determine if the device is in danger of damage due to overheating. When the die temperature reaches about +145 $^{\circ}$ C, one or both of the LDOs momentarily shut down until the die cools sufficiently. In the overheat condition, only the LDO sourcing more than 50mA will be shut off. This does not affect the operation of the other LDO. If both LDOs source more than 50mA and an overheat condition occurs, both LDO outputs are disabled. Once the die temperature falls back below about +110 $^{\circ}$ C, the disabled LDO(s) are re-enabled and soft-start automatically takes place.

© Copyright Intersil Americas LLC 2005-2008. All Rights Reserved.

All trademarks and registered trademarks are the property of their respective owners.

For additional products, see www.intersil.com/en/products.html

Intersil products are manufactured, assembled and tested utilizing ISO9001 quality systems as noted in the quality certifications found at www.intersil.com/en/support/qualandreliability.html

Intersil products are sold by description only. Intersil may modify the circuit design and/or specifications of products at any time without notice, provided that such modification does not, in Intersil's sole judgment, affect the form, fit or function of the product. Accordingly, the reader is cautioned to verify that datasheets are current before placing orders. Information furnished by Intersil is believed to be accurate and reliable. However, no responsibility is assumed by Intersil or its subsidiaries for its use; nor for any infringements of patents or other rights of third parties which may result from its use. No license is granted by implication or otherwise under any patent or patent rights of Intersil or its subsidiaries.

For information regarding Intersil Corporation and its products, see www.intersil.com

Dual Flat No-Lead Plastic Package (DFN)

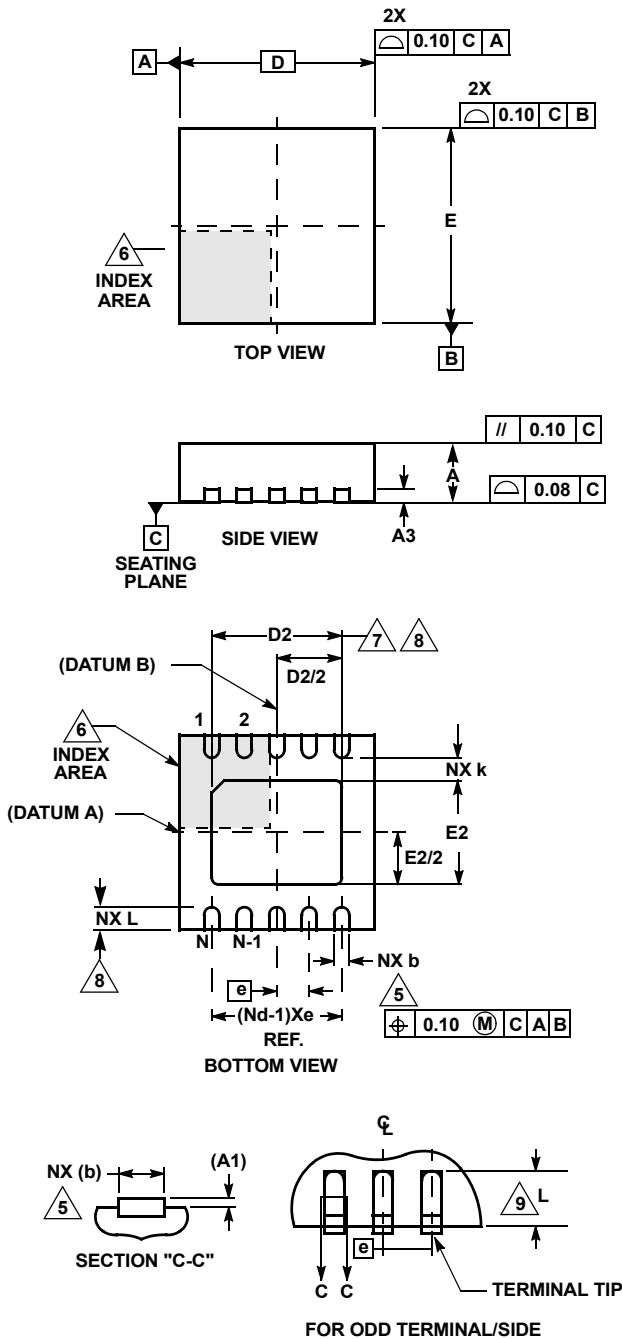

L10.3x3C

10 LEAD DUAL FLAT NO-LEAD PLASTIC PACKAGE

SYMBOL	MILLIMETERS			NOTES
	MIN	NOMINAL	MAX	
A	0.85	0.90	0.95	-
A1	-	-	0.05	-
A3	0.20 REF			-
b	0.20	0.25	0.30	5, 8
D	3.00 BSC			-
D2	2.33	2.38	2.43	7, 8
E	3.00 BSC			-
E2	1.59	1.64	1.69	7, 8
e	0.50 BSC			-
k	0.20	-	-	-
L	0.35	0.40	0.45	8
N	10			2
Nd	5			3

Rev. 1 4/06

NOTES:

1. Dimensioning and tolerancing conform to ASME Y14.5-1994.
2. N is the number of terminals.
3. Nd refers to the number of terminals on D.
4. All dimensions are in millimeters. Angles are in degrees.
5. Dimension b applies to the metallized terminal and is measured between 0.15mm and 0.30mm from the terminal tip.
6. The configuration of the pin #1 identifier is optional, but must be located within the zone indicated. The pin #1 identifier may be either a mold or mark feature.
7. Dimensions D2 and E2 are for the exposed pads which provide improved electrical and thermal performance.
8. Nominal dimensions are provided to assist with PCB Land Pattern Design efforts, see Intersil Technical Brief TB389.
9. COMPLIANT TO JEDEC MO-229-WEED-3 except for dimensions E2 & D2.