

CMOS LDO Regulator Series for Portable Equipments

Versatile Package

FULL CMOS LDO Regulator

BUxxUA3WNVX series

● **General Description**

BUxxUA3WNVX series is high-performance FULL CMOS regulator with 300-mA output, which is mounted on versatile package SSON004X1010 (1.00mm × 1.00mm × 0.60mm). It has excellent noise characteristics and load responsiveness characteristics despite its low circuit current consumption of 50μA. It is most appropriate for various applications such as power supplies for logic IC, RF, and camera modules.

● **Features**

- High accuracy detection
- low current consumption
- Compatible with small ceramic capacitor (C_{in}=C_o=1.0uF)
- With built-in output discharge circuit
- High ripple rejection
- ON/OFF control of output voltage
- With built-in over current protection circuit and thermal shutdown circuit
- Low dropout voltage

● **Key Specifications**

- Output voltage: 1.0V to 3.7V
- Accuracy output voltage: ±1.0% (±25mV)
- Low current consumption: 50μA
- Operating temperature range: -40°C to +85°C

● **Applications**

Battery-powered portable equipment, etc.

● **Package**

SSON004X1010 : 1.00mm x 1.00mm x 0.60mm



● **Typical Application Circuit**

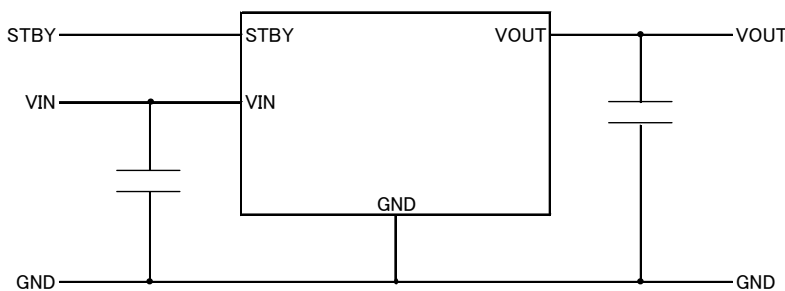
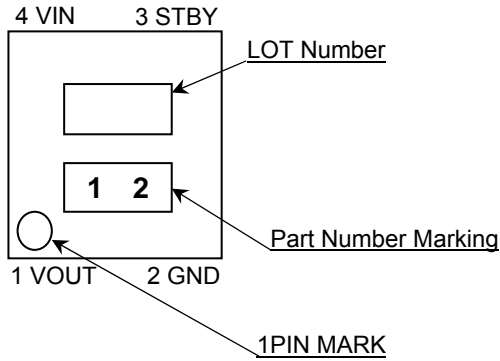

Figure 1. Application Circuit

● Connection Diagram

SSON004X1010 TOP VIEW



BOTTOM VIEW

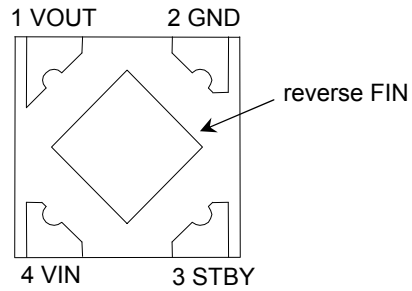

● Pin Descriptions

SSON004X1010		
PIN No.	Symbol	Function
1	VOUT	Output Voltage
2	GND	Grounding
3	STBY	ON/OFF control of output voltage (High: ON, Low: OFF)
4	VIN	Power Supply Voltage
reverse	FIN	Substrate (Connect to GND)

● Ordering Information

B		U		x		x		U		A		3		W		N		V		X		-		T		L	
Part Number	Output Voltage 10 : 1.0V ↓ 37 : 3.7V	Low Dropout Voltage	Maximum Output Current 300mA	with output discharge	Package NVX : SSON004X1010	Packaging and forming specification Embossed tape and reel TL : The pin number 1 is the lower left																					

SSON004X1010

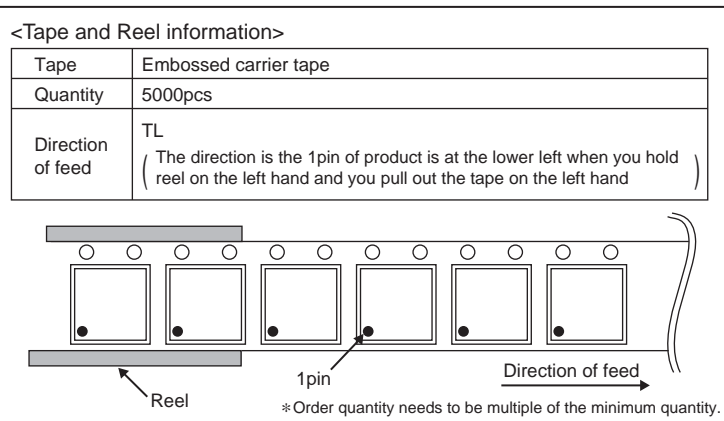
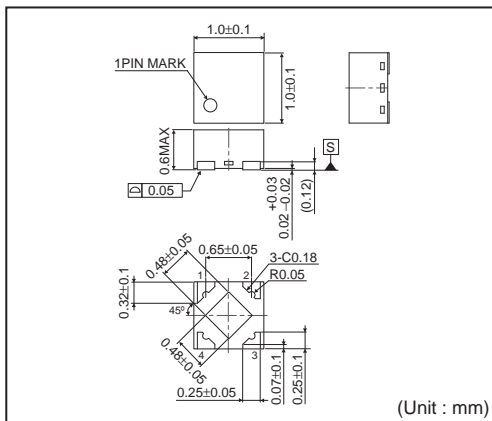

●Lineup

Marking	e	ml	nl	Ul	Yl	al	ql	Bi	f	g	bl
Output Voltage	1.0V	1.05V	1.1V	1.15V	1.2V	1.25V	1.3V	1.35V	1.5V	1.8V	1.85V
Part Number	BU10	BU1A	BU11	BU1B	BU12	BU1C	BU13	BU1D	BU15	BU18	BU1J

dl	el	fl	gl	rl	hl	h	m	ul	yl	n
1.9V	2.0V	2.05V	2.1V	2.2V	2.3V	2.5V	2.6V	2.7V	2.75V	2.8V
BU19	BU20	BU2A	BU21	BU22	BU23	BU25	BU26	BU27	BU2H	BU28

z	u	0i	k	1i	2i	y	3i	9
2.85V	2.9V	2.95V	3.0V	3.1V	3.2V	3.3V	3.4V	3.7V
BU2J	BU29	BU2K	BU30	BU31	BU32	BU33	BU34	BU37

●Absolute Maximum Ratings (Ta=25°C)

PARAMETER	Symbol	Limit	Unit
Power Supply Voltage	VMAX	-0.3 ~ +6.0	V
Power Dissipation	Pd	560(*1)	mW
Maximum junction temperature	TJMAX	+125	°C
Operating Temperature Range	Topr	-40 ~ +85	°C
Storage Temperature Range	Tstg	-55 ~ +125	°C

(*1) Pd deleted at 5.6mW/°C at temperatures above Ta=25°C, mounted on 70×70×1.6 mm glass-epoxy PCB.

● RECOMMENDED OPERATING RANGE (not to exceed Pd)

PARAMETER	Symbol	Limit	Unit
Power Supply Voltage	VIN	1.7~5.5	V
Maximum Output Current	IMAX	300	mA

●OPERATING CONDITIONS

PARAMETER	Symbol	MIN.	TYP.	MAX.	Unit	CONDITION
Input Capacitor	Cin	0.47(*2)	1.0	-	μF	Ceramic capacitor recommended
Output Capacitor	Co	0.47(*2)	1.0	-	μF	

(*2) Make sure that the output capacitor value is not kept lower than this specified level across a variety of temperature, DC bias, characteristic.

●Electrical Characteristics

(Ta=25°C, VIN=VOUT+1.0V (*3), STBY=VIN, Cin=1.0μF, Co=1.0μF, unless otherwise noted.)

PARAMETER	Symbol	Limit			Unit	Conditions	
		MIN.	TYP.	MAX.			
Overall Device							
Output Voltage	VOUT	VOUT×0.99	VOUT	VOUT×1.01	V	IOUT=10 μA, VOUT ≥ 2.5V	
		VOUT-25mV		VOUT+25mV		IOUT=10 μA, VOUT < 2.5V	
Operating Current	IIN	-	50	90	μA	IOUT=0mA	
Operating Current (STBY)	ISTBY	-	-	1.0	μA	STBY=0V	
Ripple Rejection Ratio	RR	45	70	-	dB	VRR=-20dBv, fRR=1kHz, IOUT=150mA, VIN=3.6V	
Dropout Voltage	VSAT	-	470	700	mV	1.0V ≤ VOUT < 1.2V (IOUT=300mA)	
		-	350	500	mV	1.2V ≤ VOUT < 1.5V (IOUT=300mA)	
		-	280	380	mV	1.5V ≤ VOUT < 1.7V (IOUT=300mA)	
		-	250	320	mV	1.7V ≤ VOUT < 2.1V (IOUT=300mA)	
		-	220	260	mV	2.1V ≤ VOUT < 2.5V (IOUT=300mA)	
		-	200	220	mV	2.5V ≤ VOUT (IOUT=300mA)	
Line Regulation	VDL	-	2	20	mV	VIN=VOUT+1.0V to 5.5V(*4), IOUT=10μA	
Load Regulation	VDLO	-	25	45	mV	IOUT=0.01mA to 300mA	
Over-current Protection (OCP)							
Limit Current	ILMAX	370	550	-	mA	Vo=VOUT*0.95	
Short Current	ISHORT	50	150	300	mA	Vo=0V	
Standby Block							
Discharge Resistor	RDSC	20	50	80	Ω	VIN=5.5V, STBY=0V, VOUT=2.6V	
STBY Pin Pull-down Current	ISTB	0.1	0.9	8.0	μA	STBY=1.5V	
STBY Control Voltage	ON	VSTBH	1.2	-	5.5	V	
	OFF	VSTBL	-0.3	-	0.3	V	

○This product is not designed for protection against radioactive rays.

(*3) VIN=2.5V for VOUT ≤ 1.5V

(*4) VIN=2.5V to 5.5V for VOUT ≤ 1.5V

●Block Diagrams

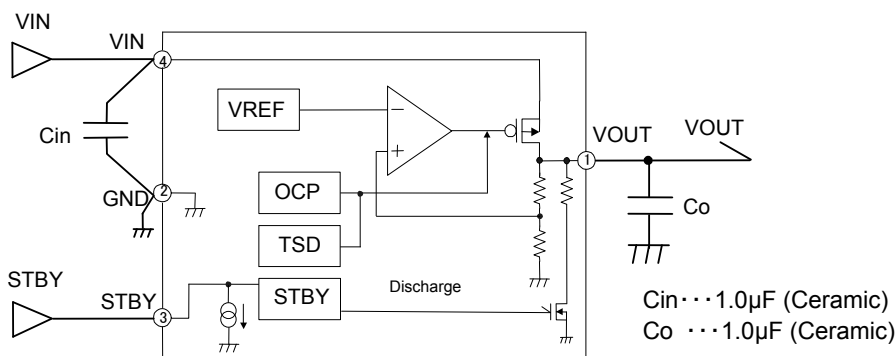

Figure 2. Block Diagrams

● Reference data **BU10UA3WNVX** (Ta=25°C unless otherwise specified.)

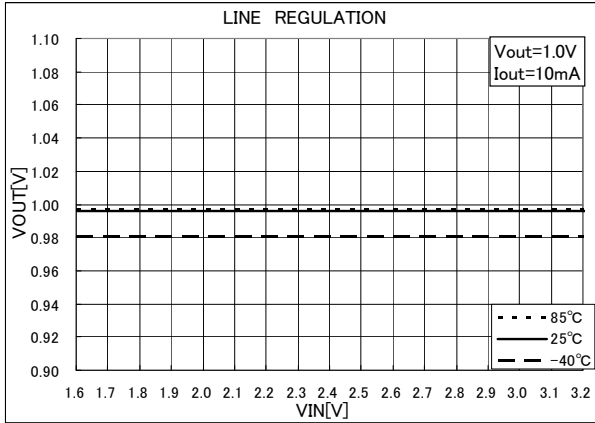

Figure 3.

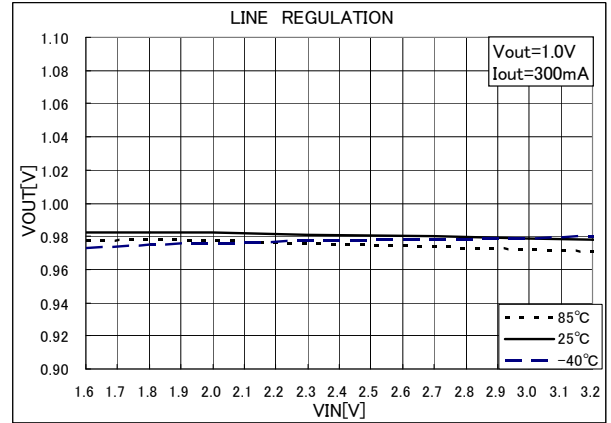

Figure 4.

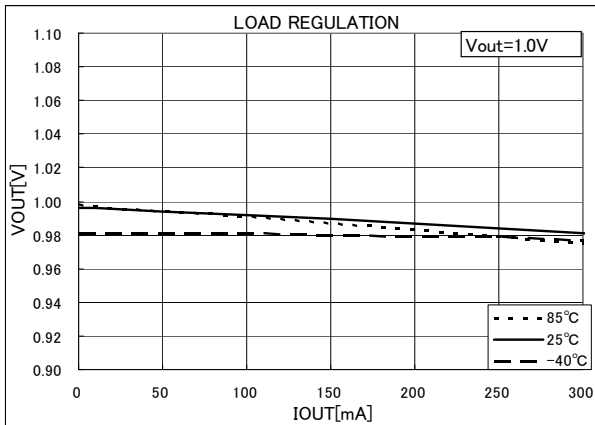

Figure 5.

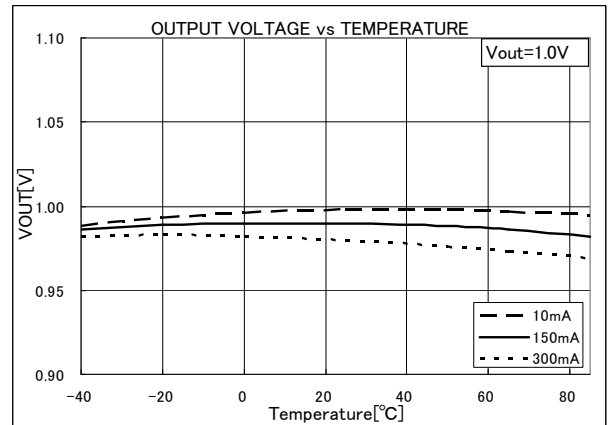

Figure 6.

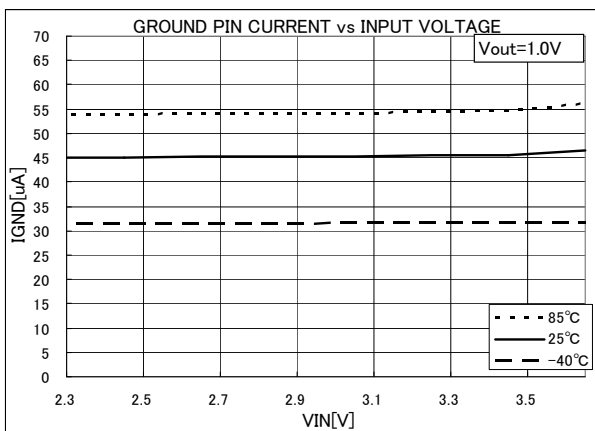

Figure 7.

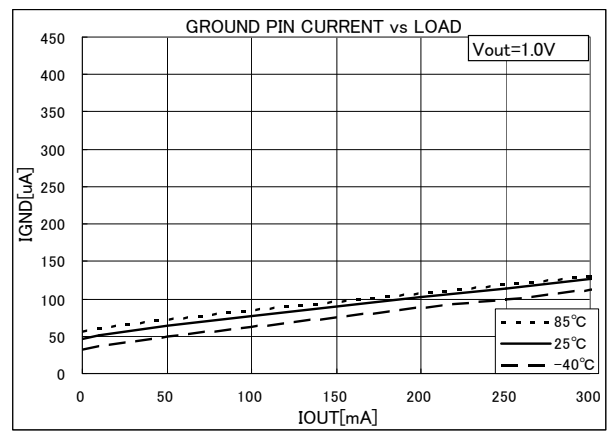

Figure 8.

● Reference data **BU10UA3WNVX** (Ta=25°C unless otherwise specified.)

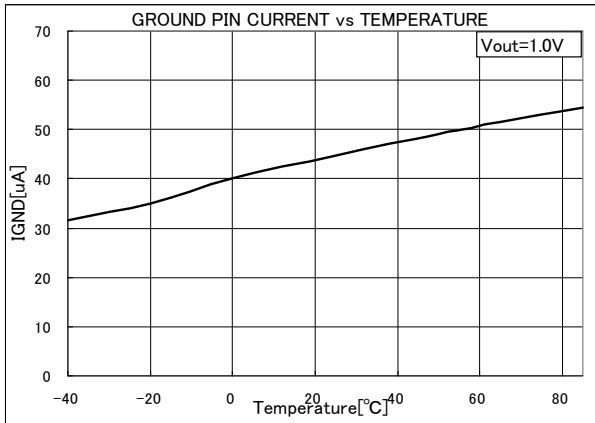

Figure 9.

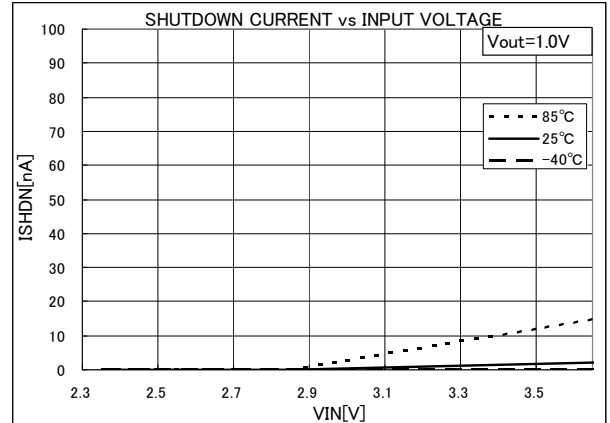

Figure 10.

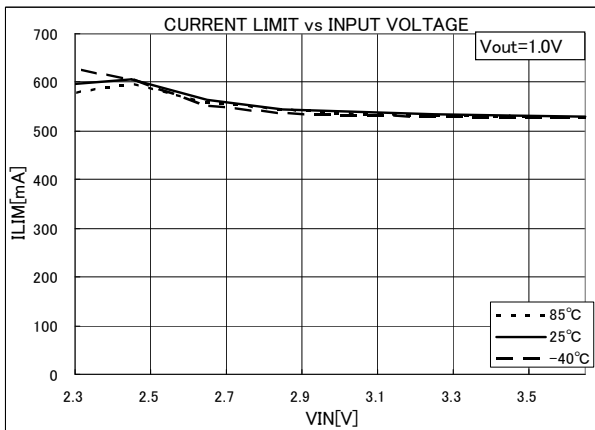

Figure 11.

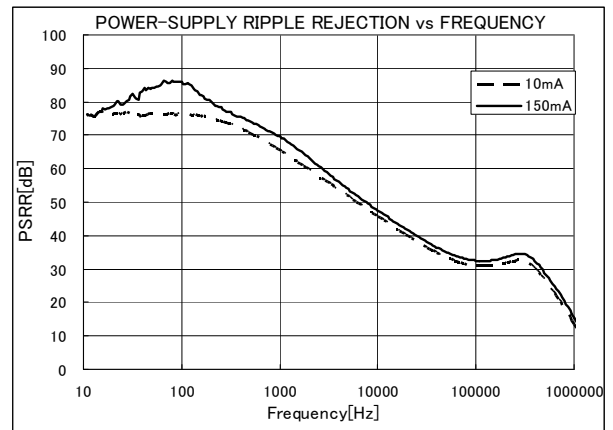

Figure 12.

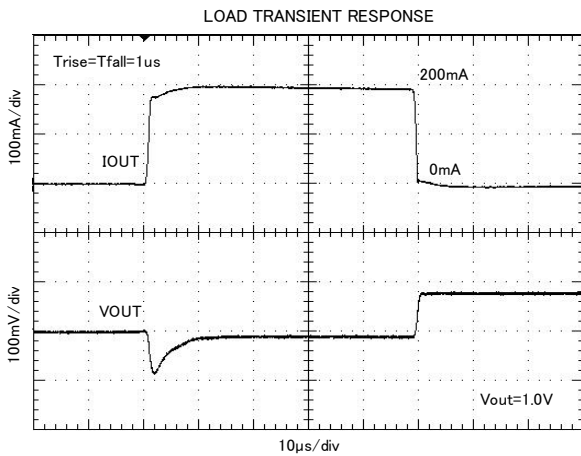

Figure 13.

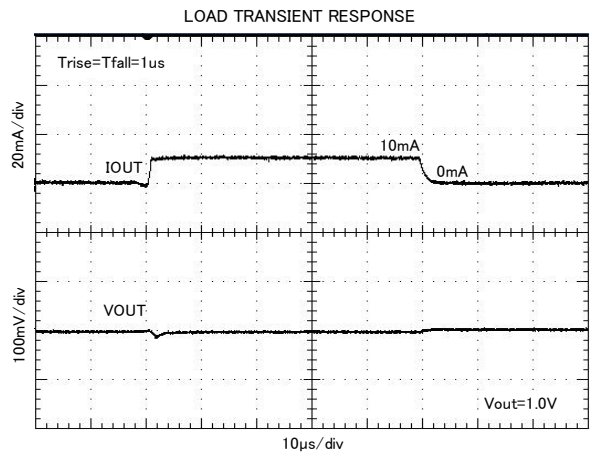

Figure 14.

● Reference data **BU10UA3WNVX** ($T_a=25^\circ\text{C}$ unless otherwise specified.)

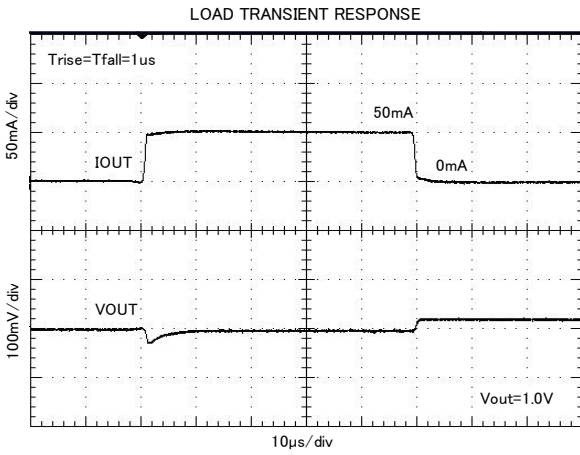

Figure 15.

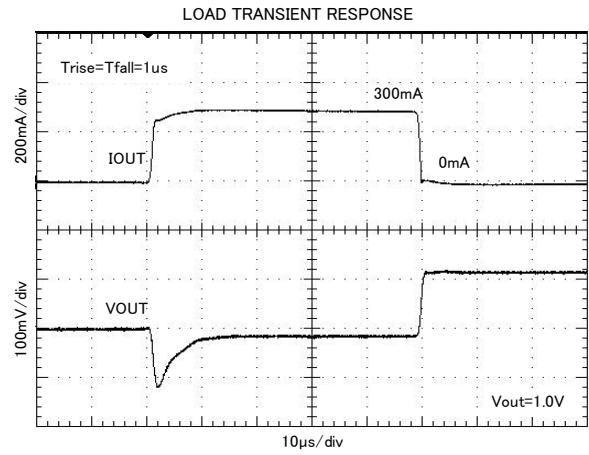

Figure 16.

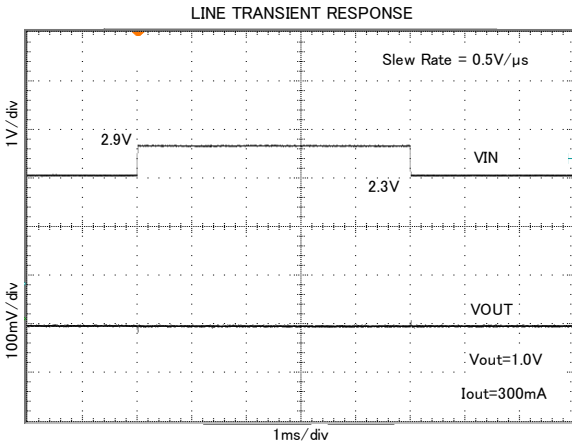

Figure 17.

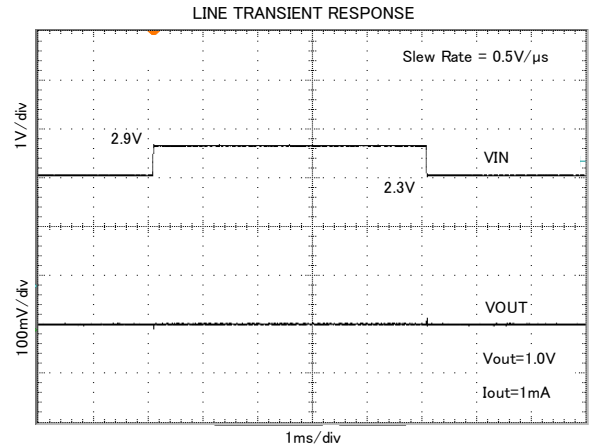

Figure 18.

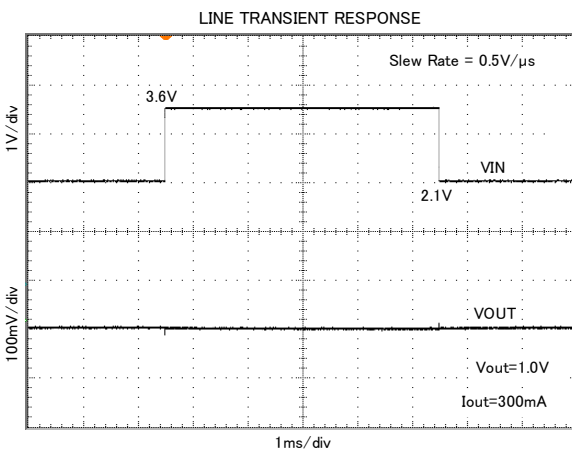

Figure 19.

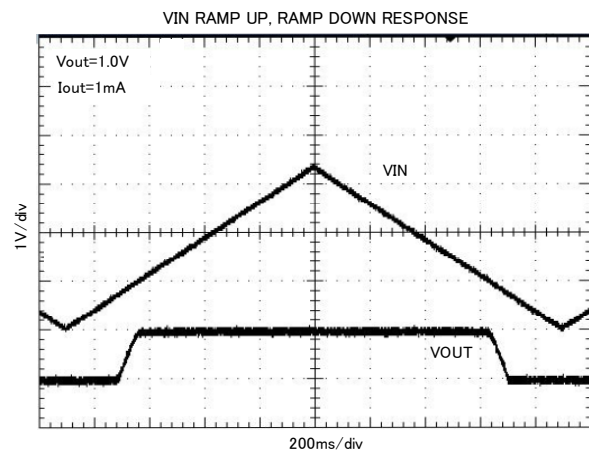

Figure 20.

● Reference data **BU10UA3WNVX** (Ta=25°C unless otherwise specified.)

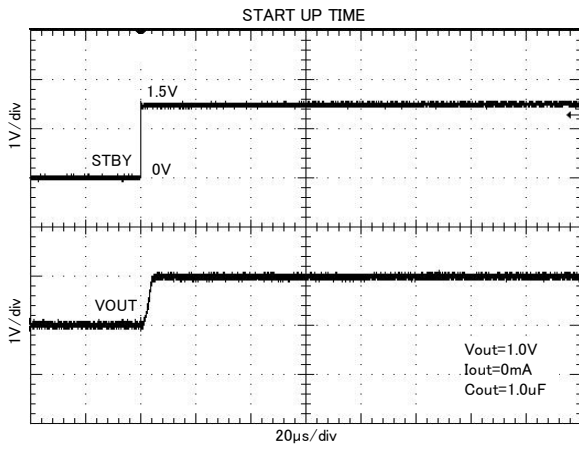

Figure 21.

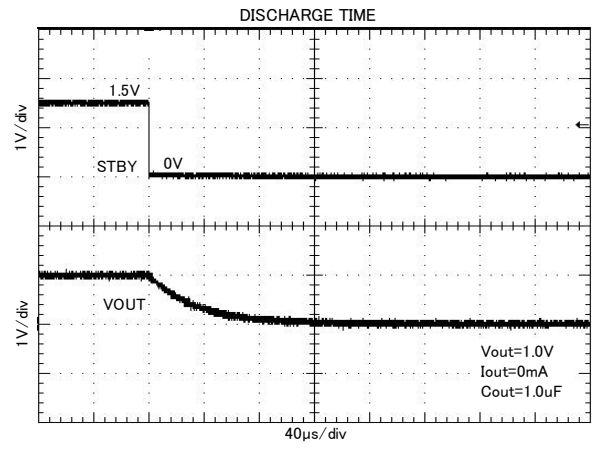

Figure 22.

● Reference data **BU11UA3WNVX** (Ta=25°C unless otherwise specified.)

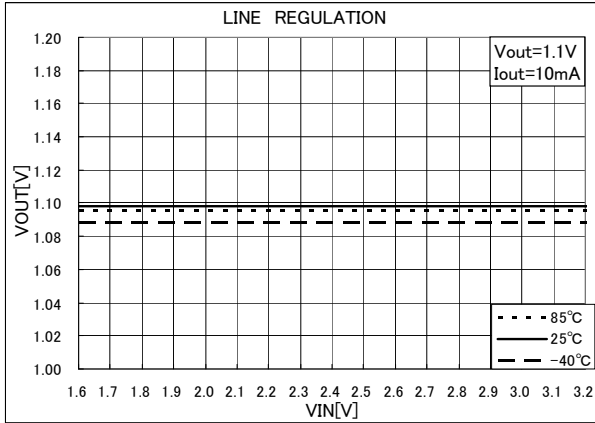

Figure 23.

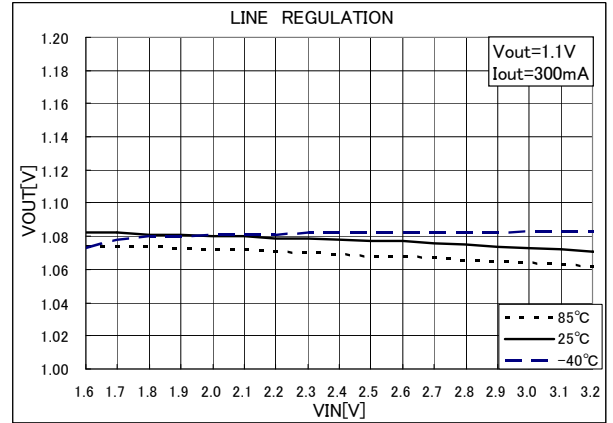

Figure 24.

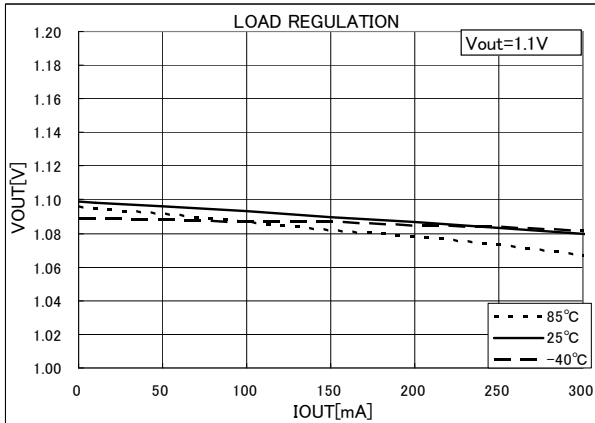

Figure 25.

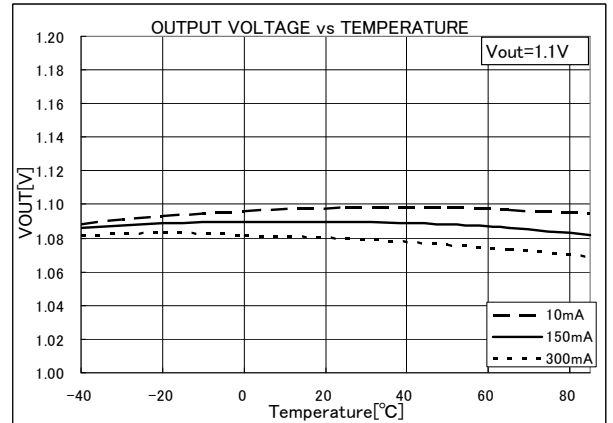

Figure 26.

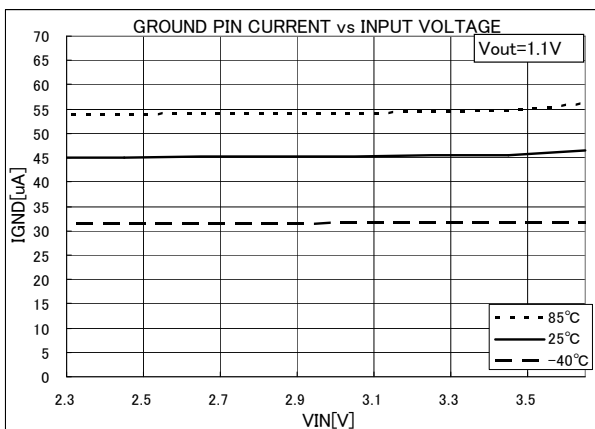

Figure 27.

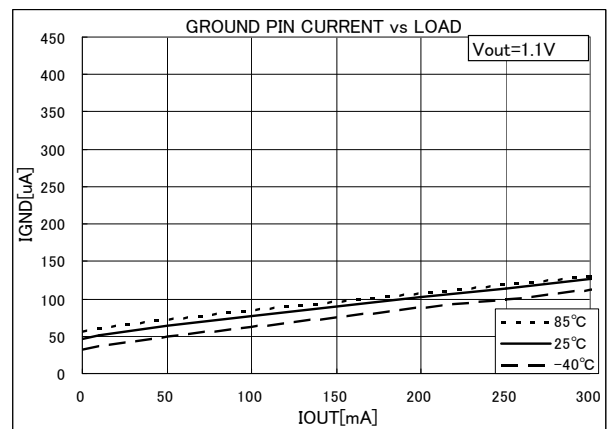

Figure 28.

● Reference data **BU11UA3WNVX** (Ta=25°C unless otherwise specified.)

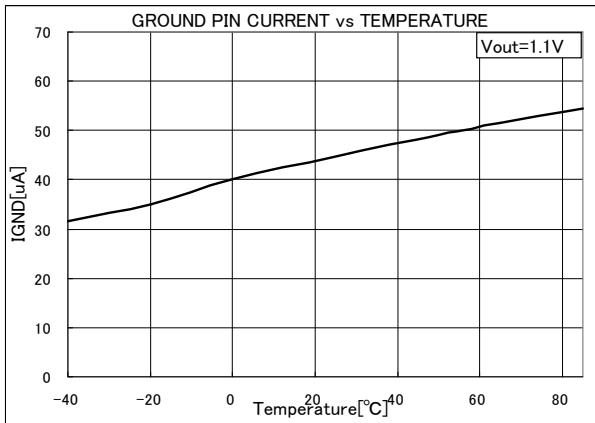

Figure 29.

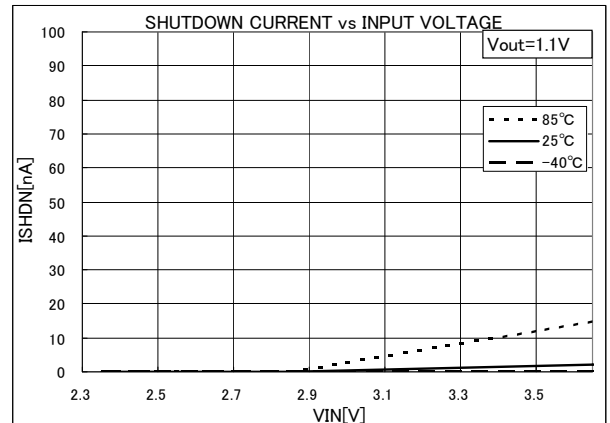

Figure 30.

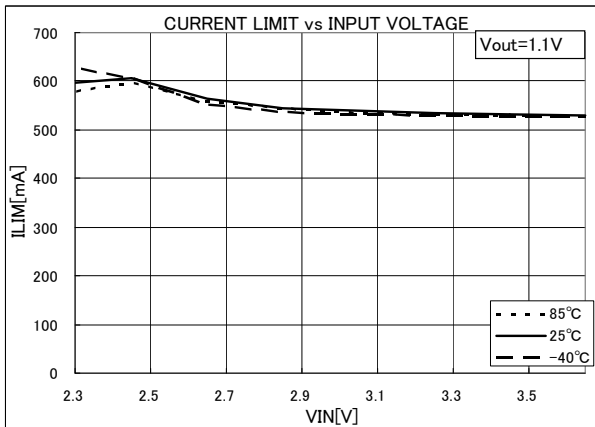

Figure 31.

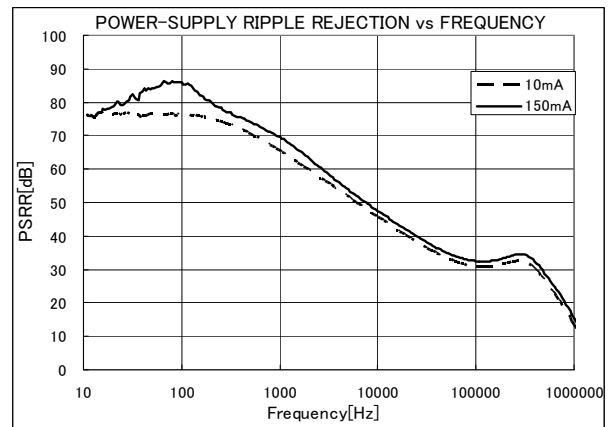

Figure 32.

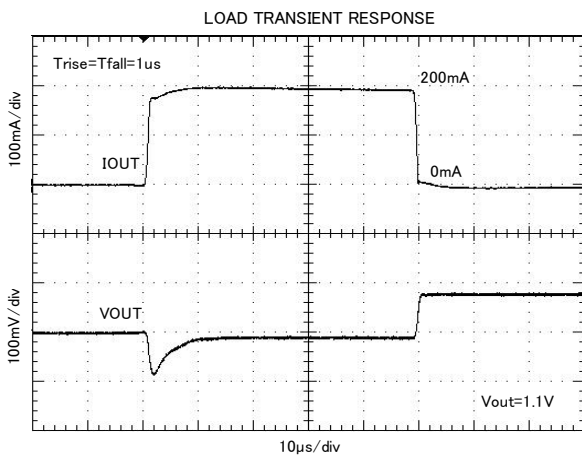

Figure 33.

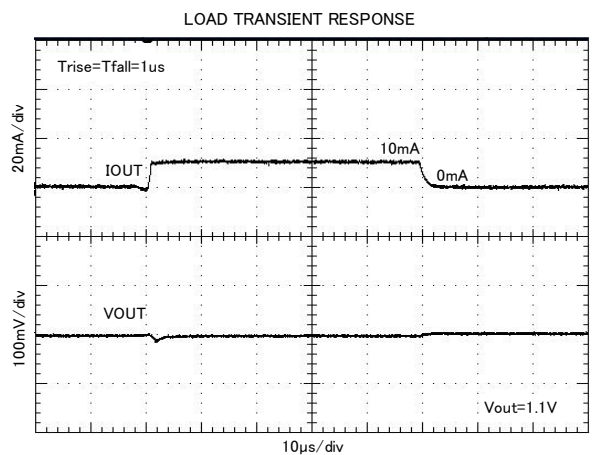

Figure 34.

● Reference data **BU11UA3WNVX** ($T_a=25^\circ\text{C}$ unless otherwise specified.)

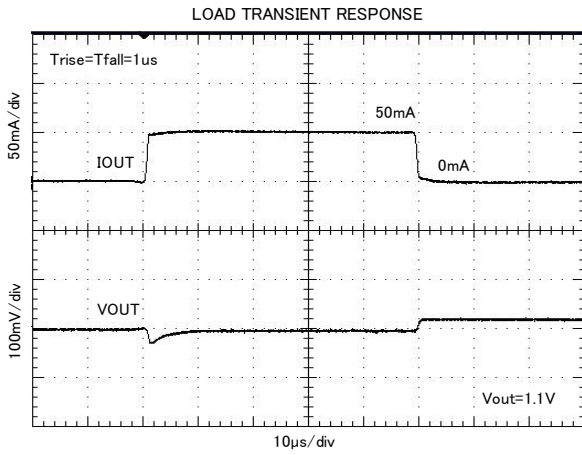

Figure 35.

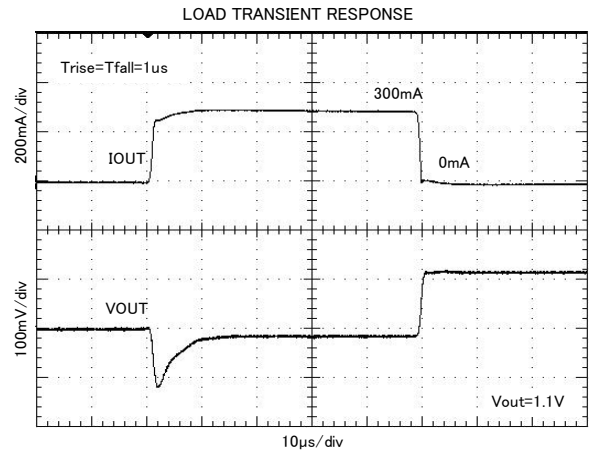

Figure 36.

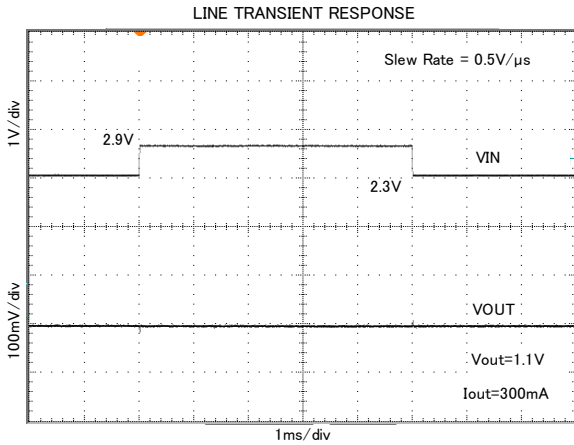

Figure 37.

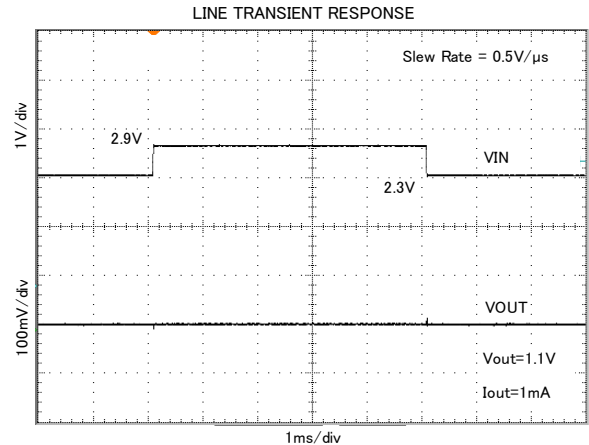

Figure 38.

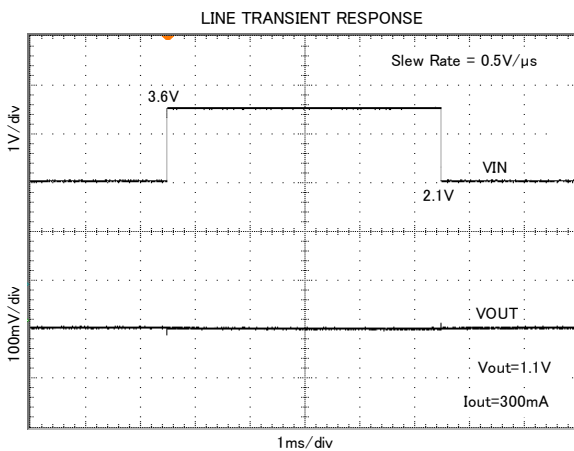

Figure 39.

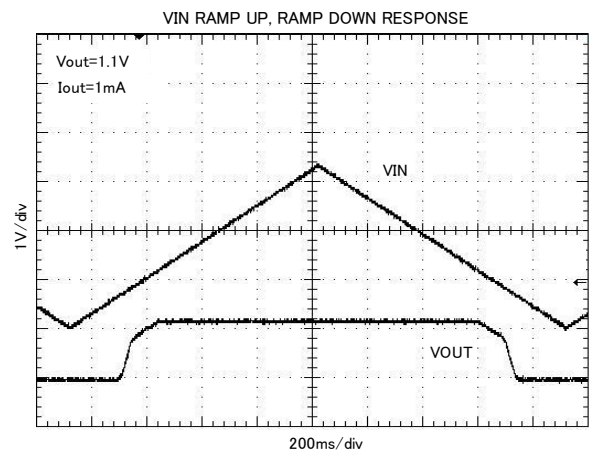

Figure 40.

● Reference data **BU11UA3WNVX** (Ta=25°C unless otherwise specified.)

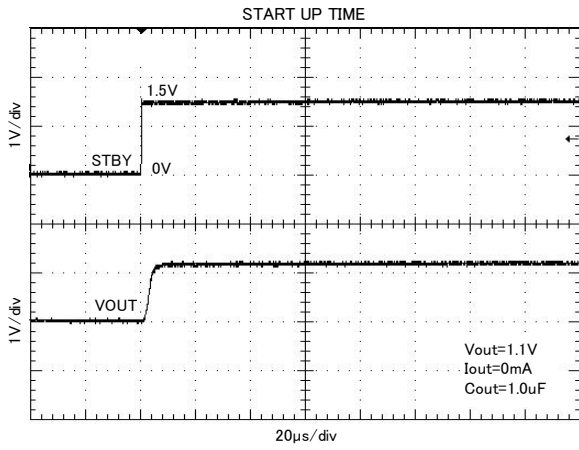

Figure 41.

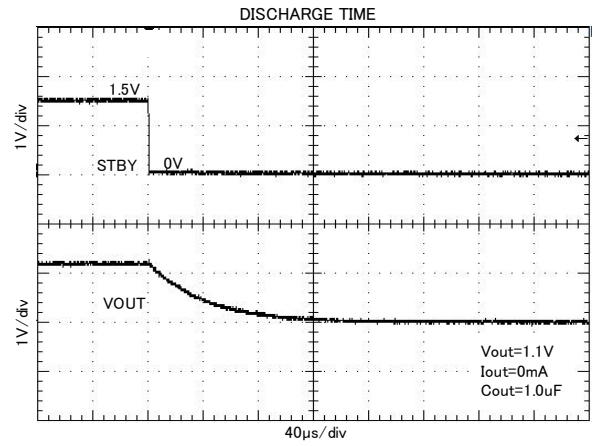

Figure 42.

● Reference data **BU12UA3WNVX** (Ta=25°C unless otherwise specified.)

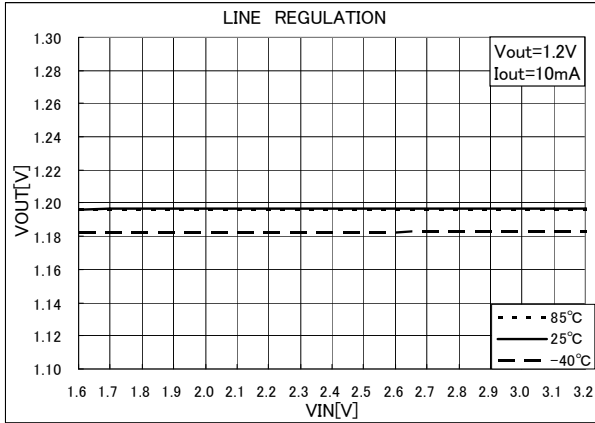

Figure 43.

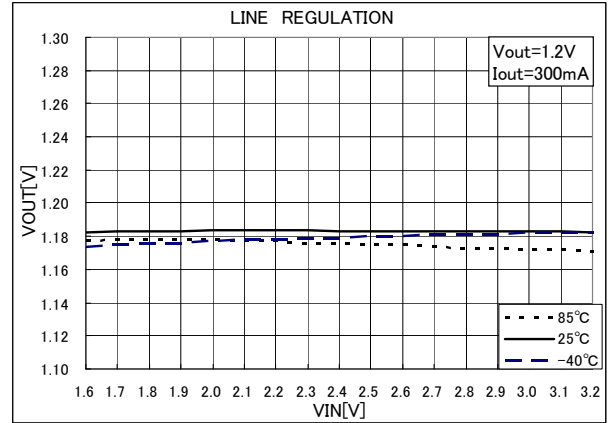

Figure 44.

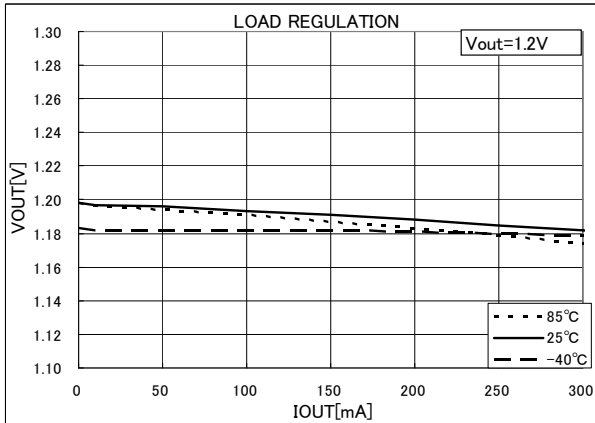

Figure 45.

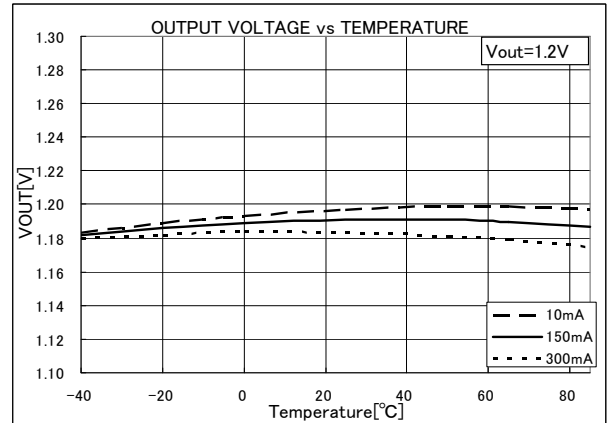

Figure 46.

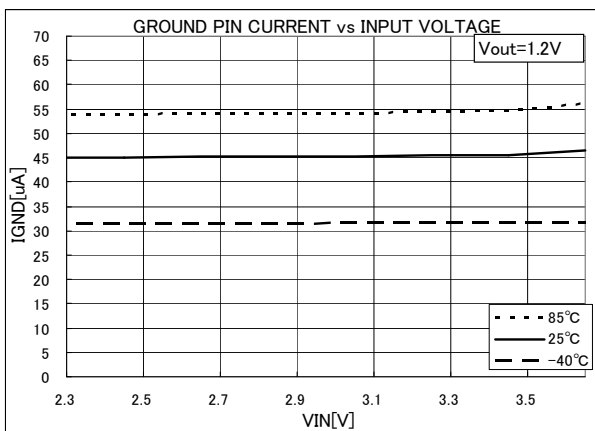

Figure 47.

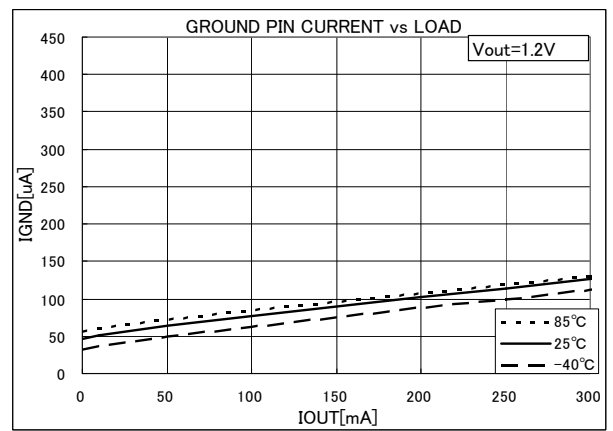

Figure 48.

● Reference data **BU12UA3WNVX** (Ta=25°C unless otherwise specified.)

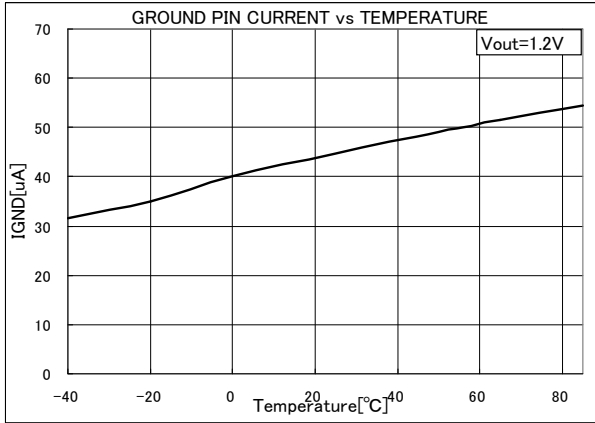

Figure 49.

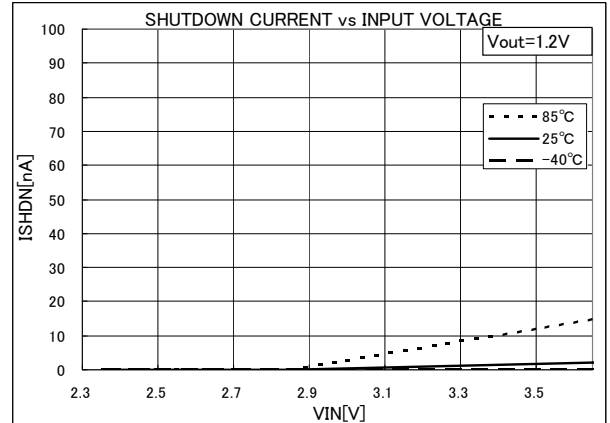

Figure 50.

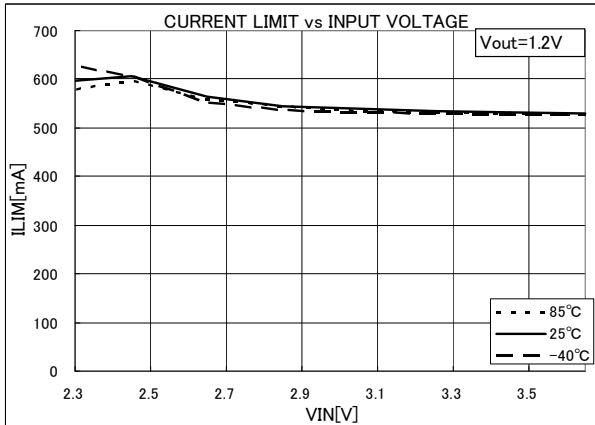

Figure 51.

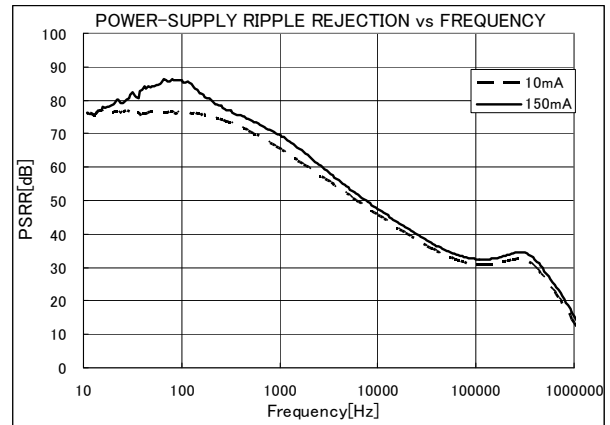

Figure 52.

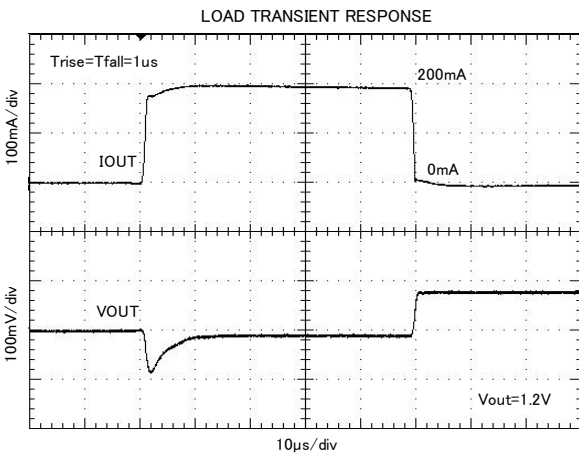

Figure 53.

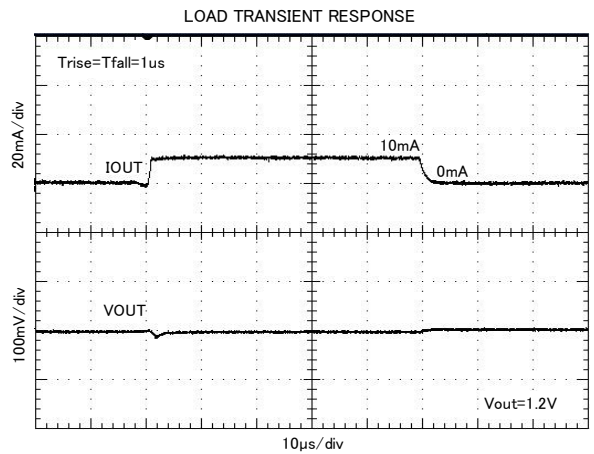

Figure 54.

● Reference data **BU12UA3WNVX** (Ta=25°C unless otherwise specified.)

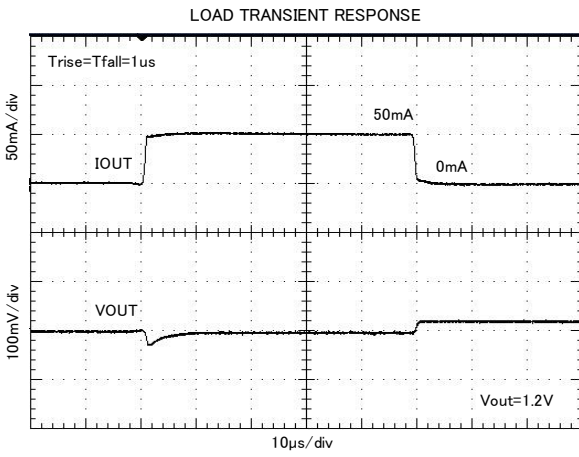

Figure 55.

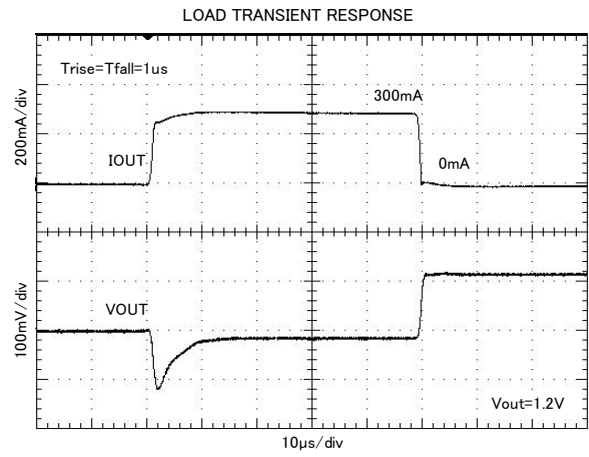

Figure 56.

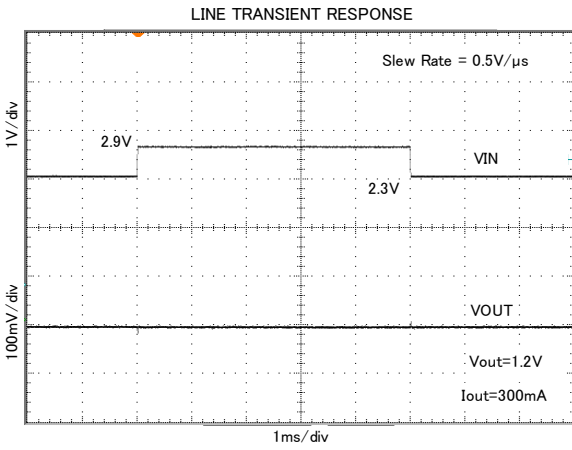

Figure 57.

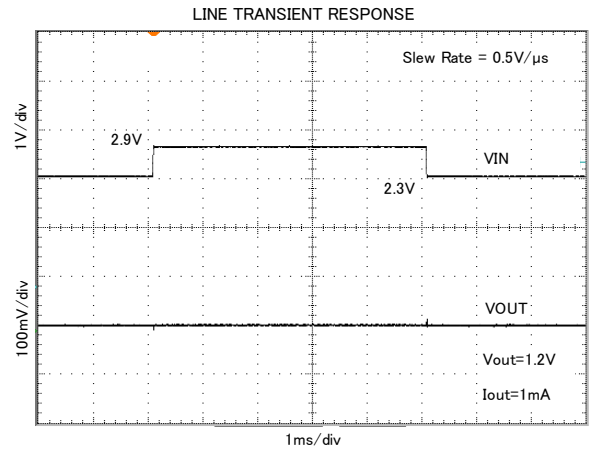

Figure 58.

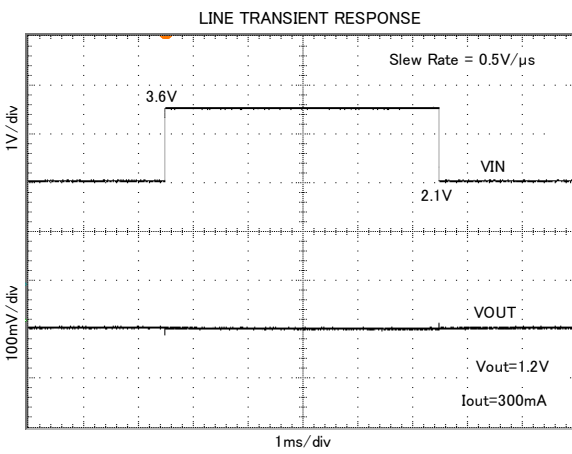

Figure 59.

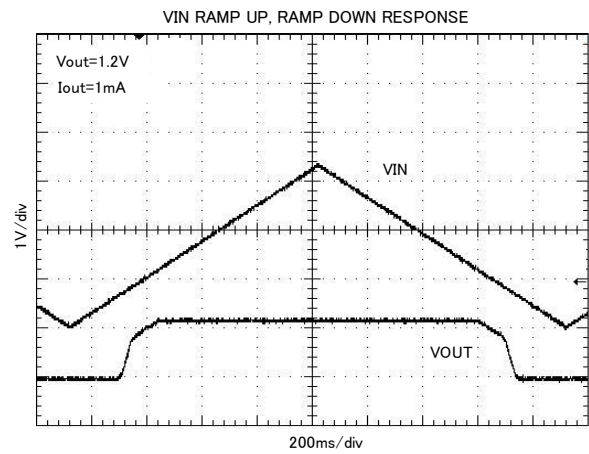

Figure 60.

● Reference data **BU12UA3WNVX** (Ta=25°C unless otherwise specified.)

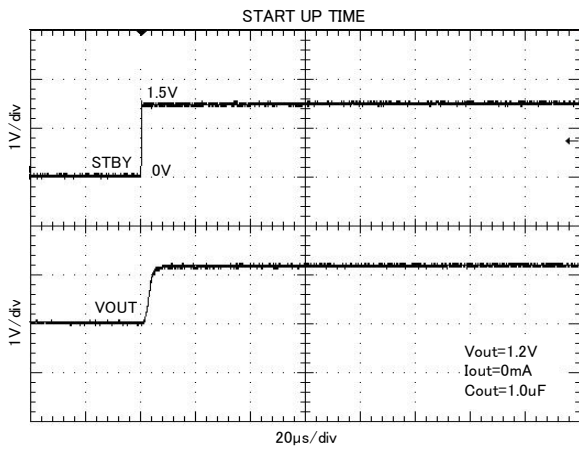

Figure 61.

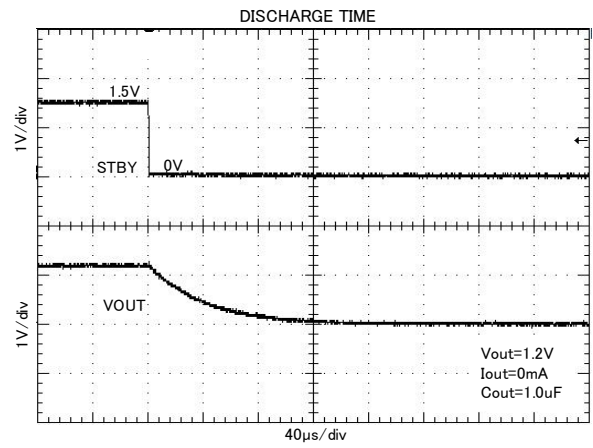

Figure 62.

● Reference data **BU18UA3WNVX** (Ta=25°C unless otherwise specified.)

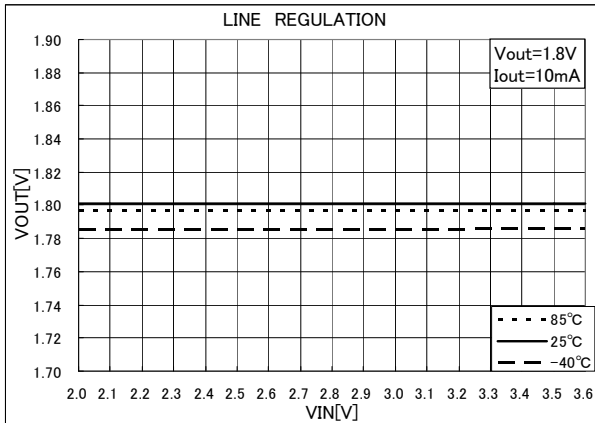

Figure 63.

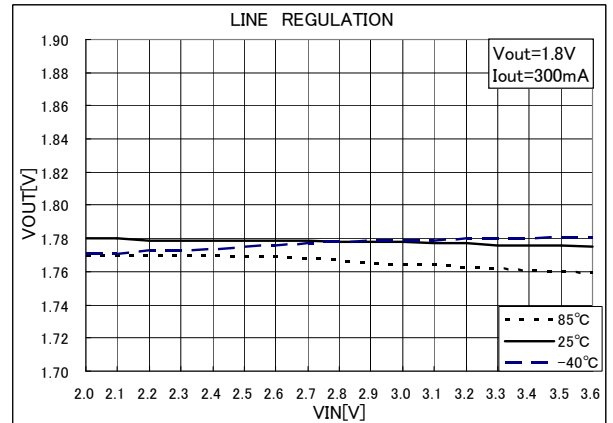

Figure 64.

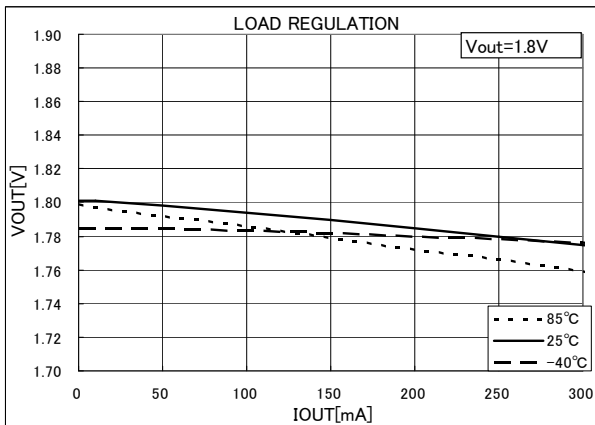

Figure 65.

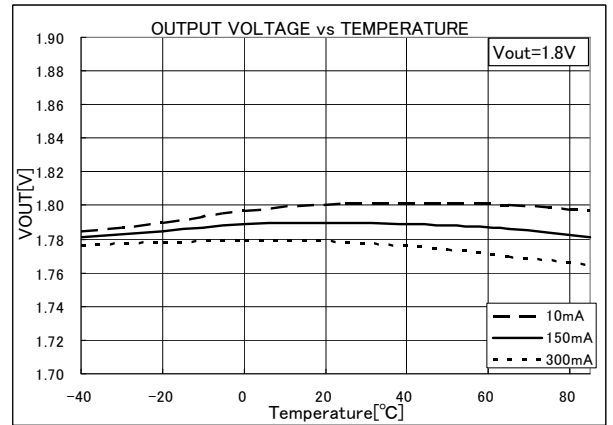

Figure 66.

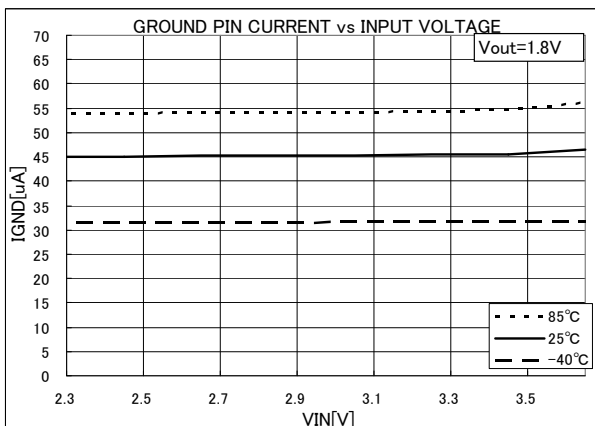

Figure 67.

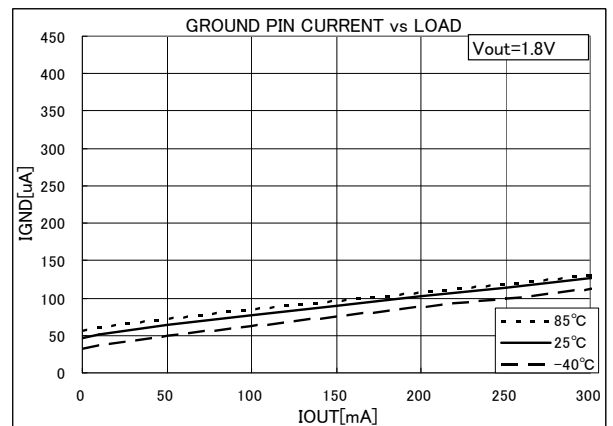

Figure 68.

● Reference data **BU18UA3WNVX** (Ta=25°C unless otherwise specified.)

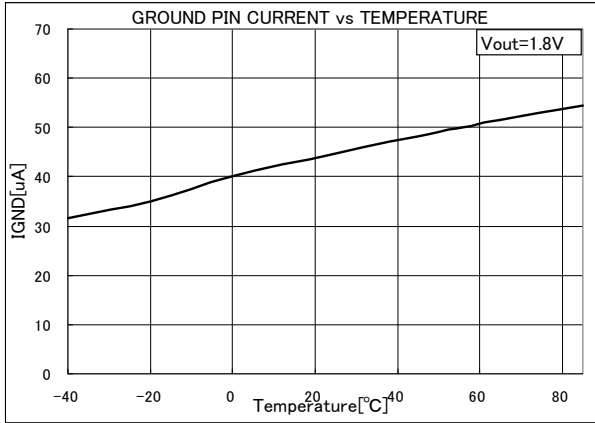

Figure 69.

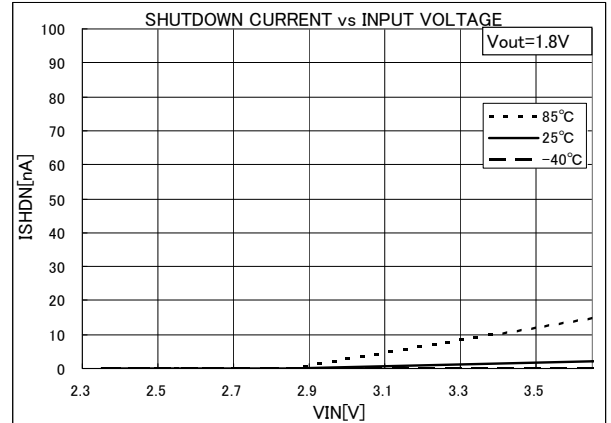

Figure 70.

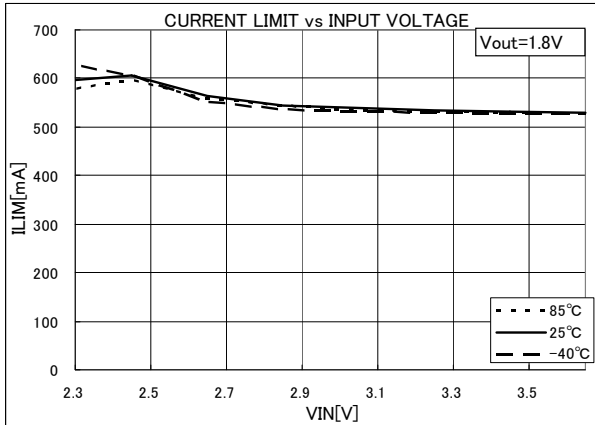

Figure 71.

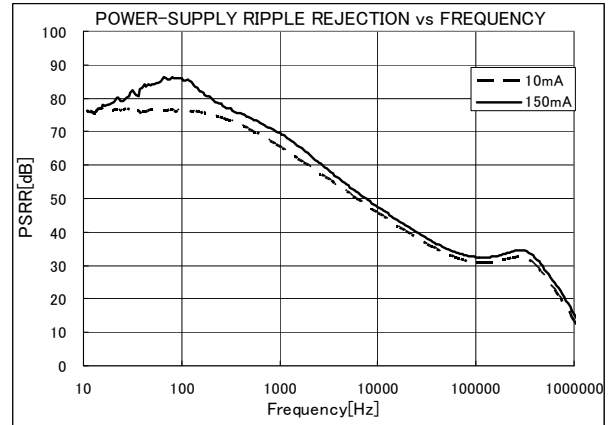

Figure 72.

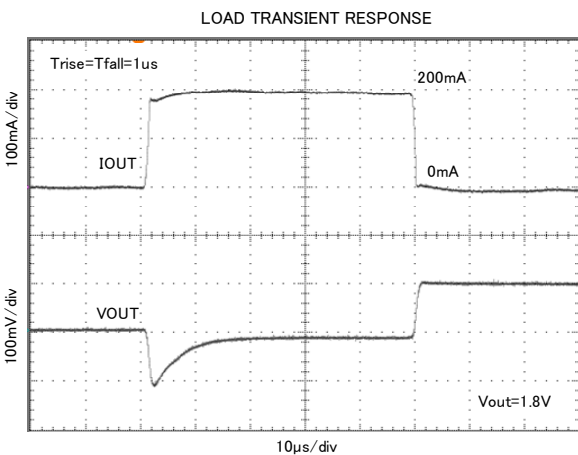

Figure 73.

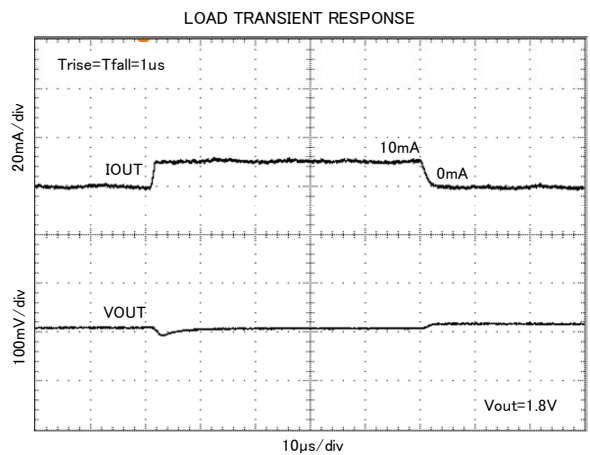

Figure 74.

● Reference data **BU18UA3WNVX** ($T_a=25^{\circ}\text{C}$ unless otherwise specified.)

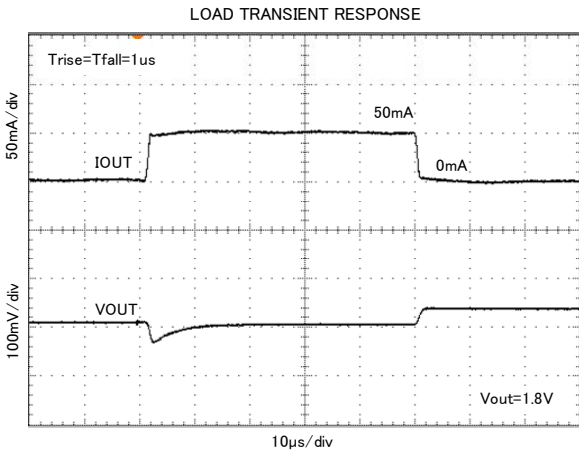

Figure 75.

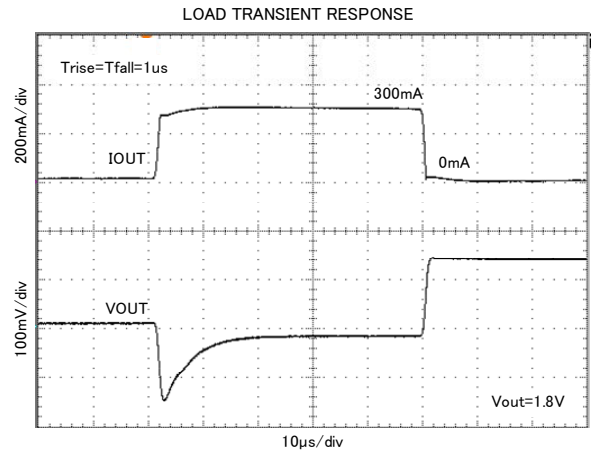

Figure 76.

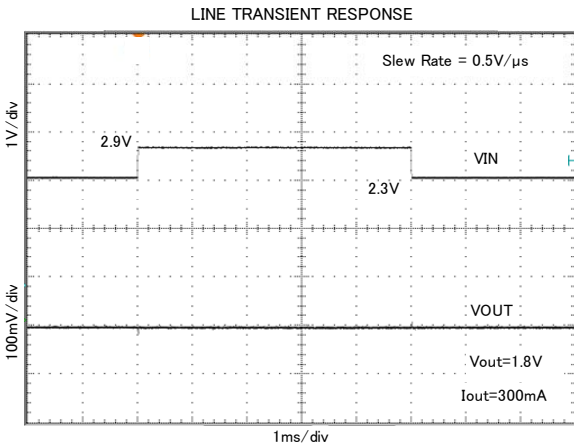

Figure 77.

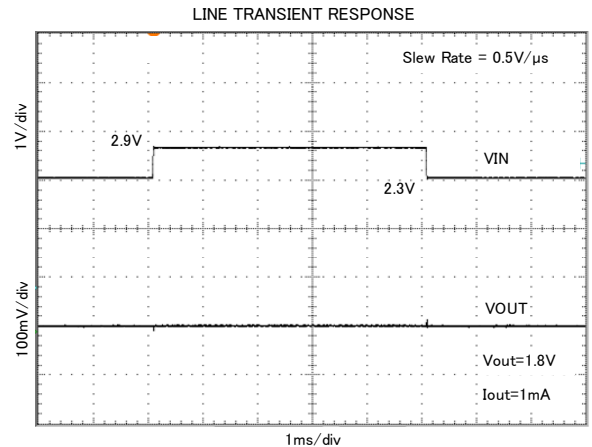

Figure 78.

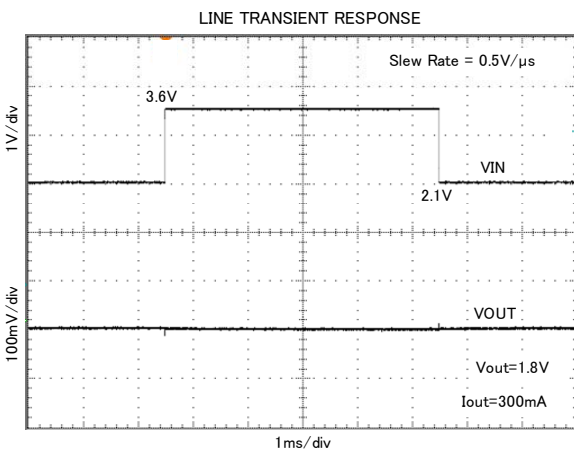

Figure 79.

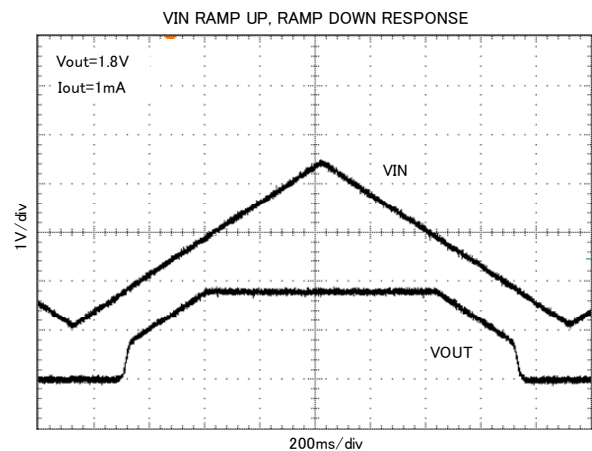

Figure 80.

● Reference data **BU18UA3WNVX** (Ta=25°C unless otherwise specified.)

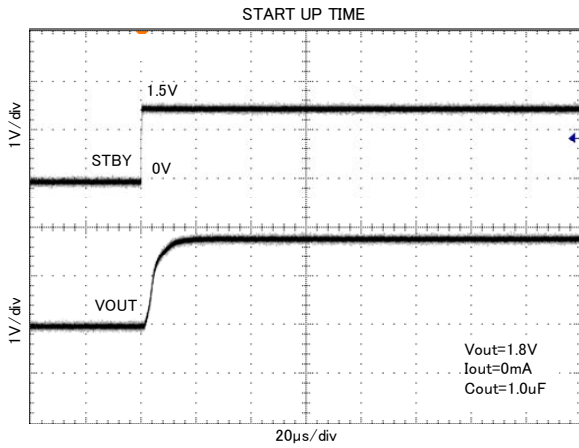

Figure 81.

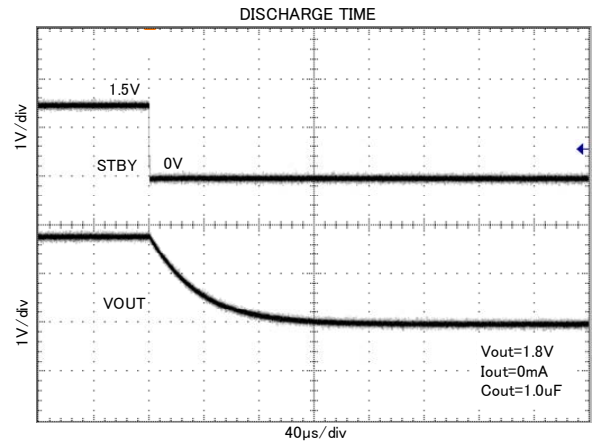

Figure 82.

● Reference data **BU31UA3WNVX** (Ta=25°C unless otherwise specified.)

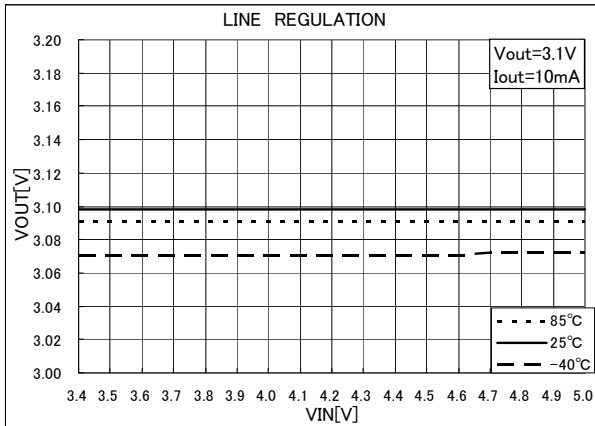

Figure 83.

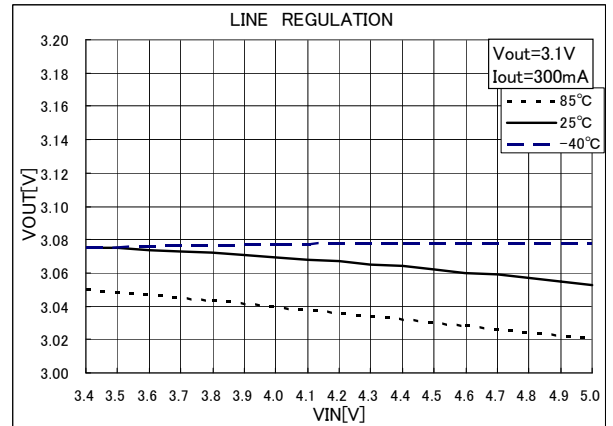

Figure 84.

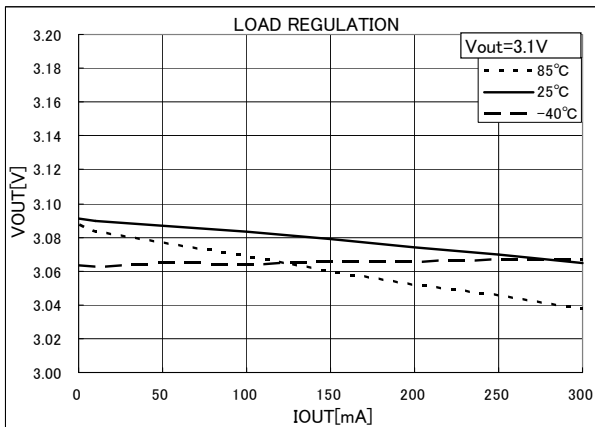

Figure 85.

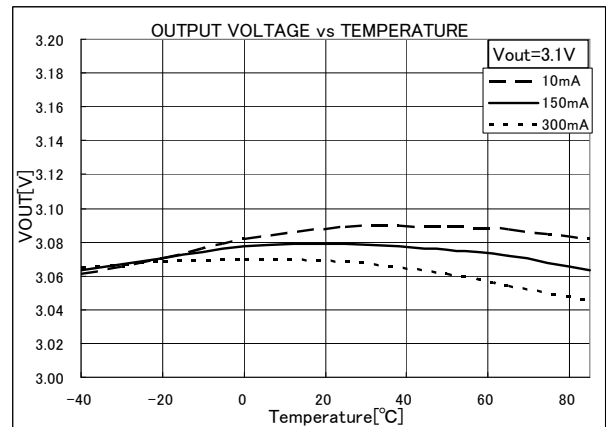

Figure 86.

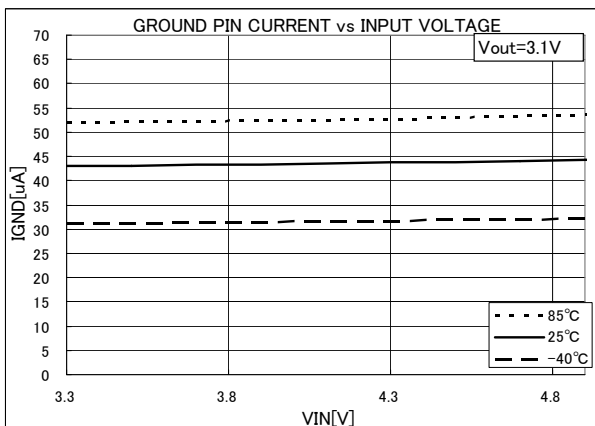

Figure 87.

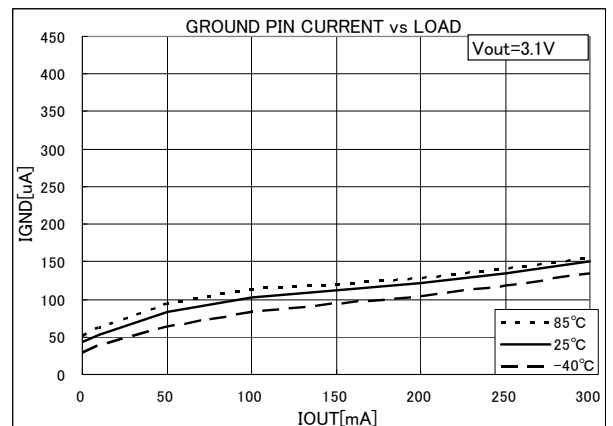

Figure 88.

● Reference data **BU31UA3WNVX** (Ta=25°C unless otherwise specified.)

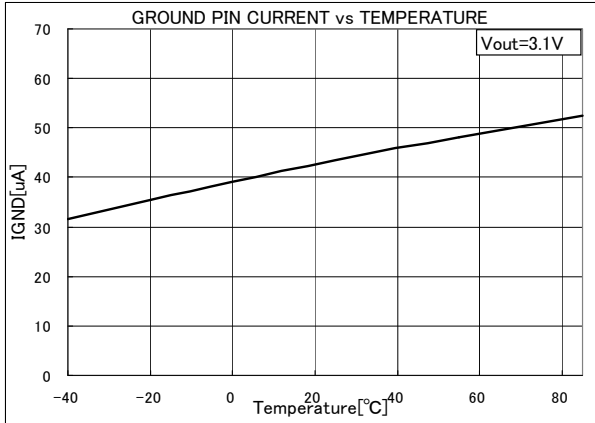

Figure 89.

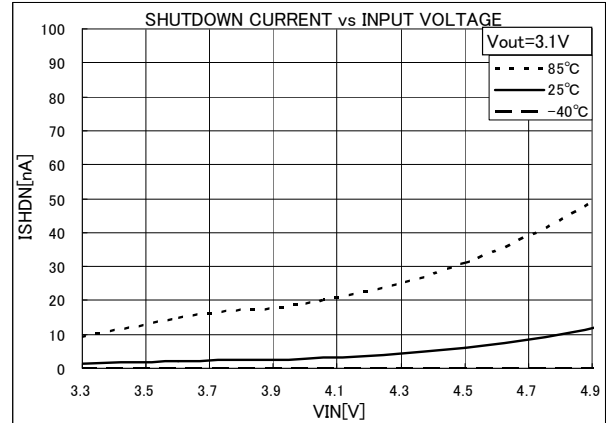

Figure 90.

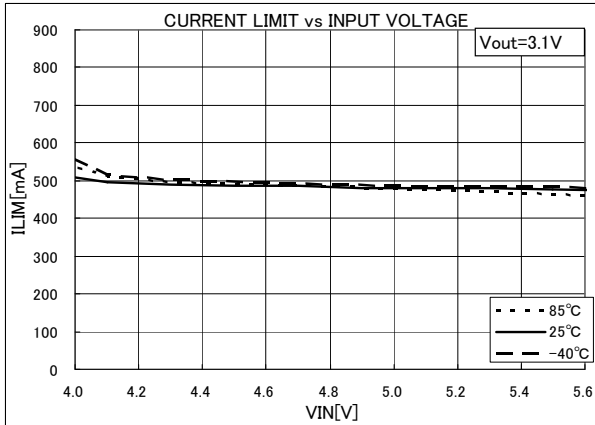

Figure 91.

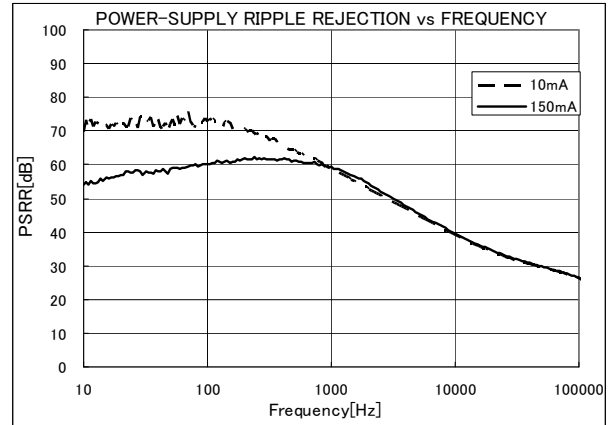

Figure 92.

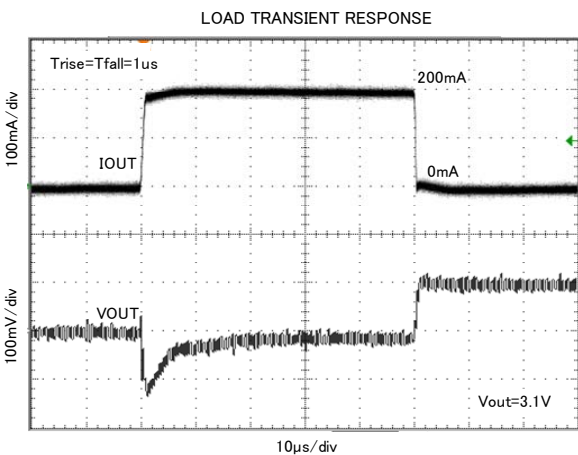

Figure 93.

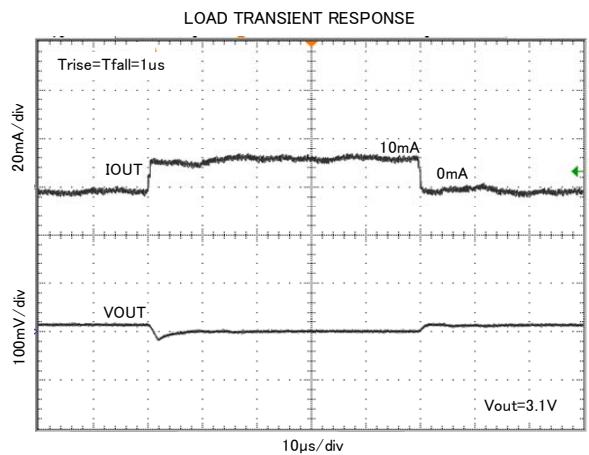

Figure 94.

● Reference data **BU31UA3WNVX** ($T_a=25^\circ\text{C}$ unless otherwise specified.)

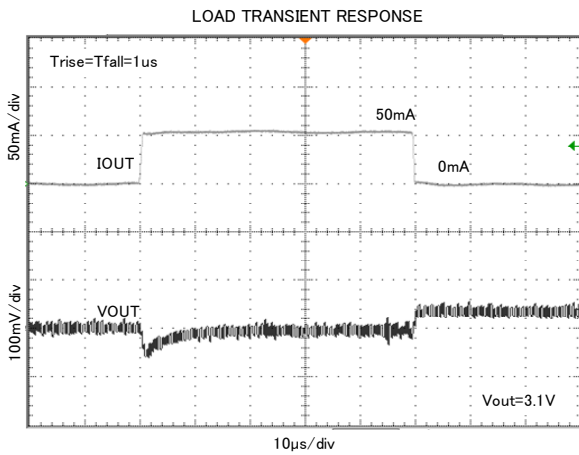

Figure 95.

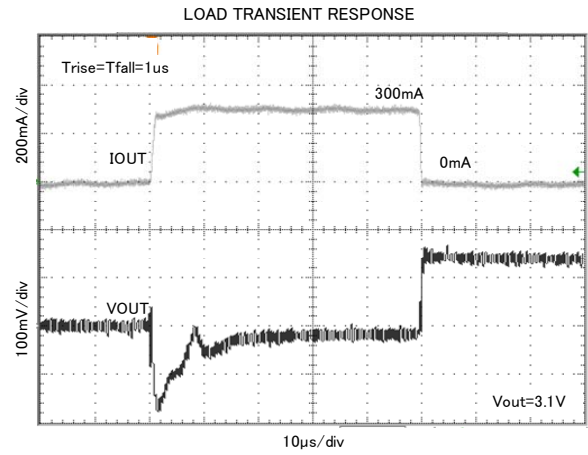

Figure 96.

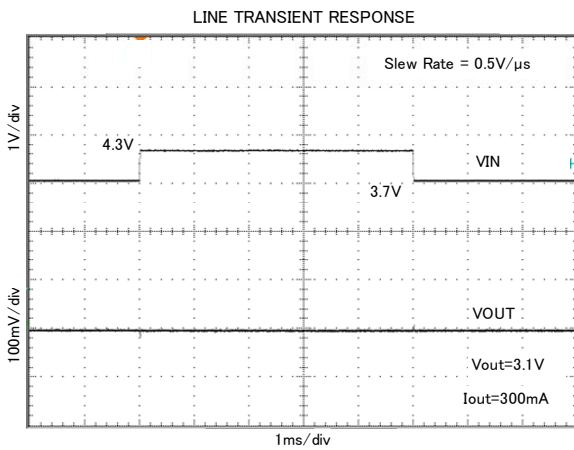

Figure 97.

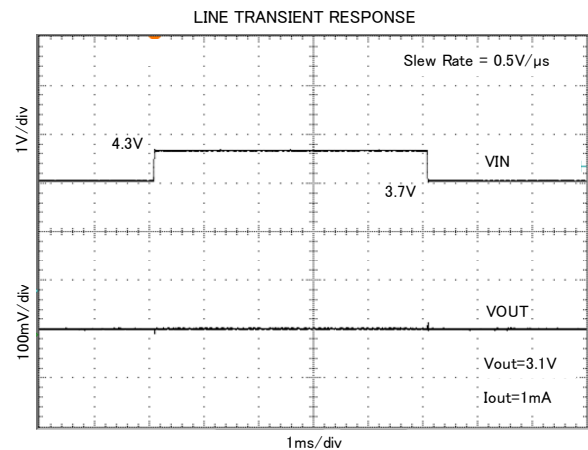

Figure 98.

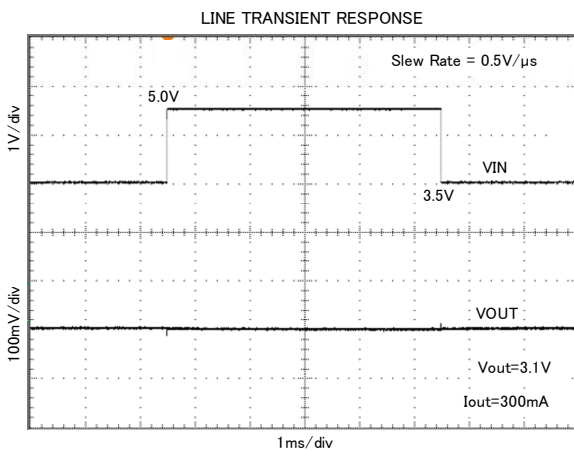

Figure 99.

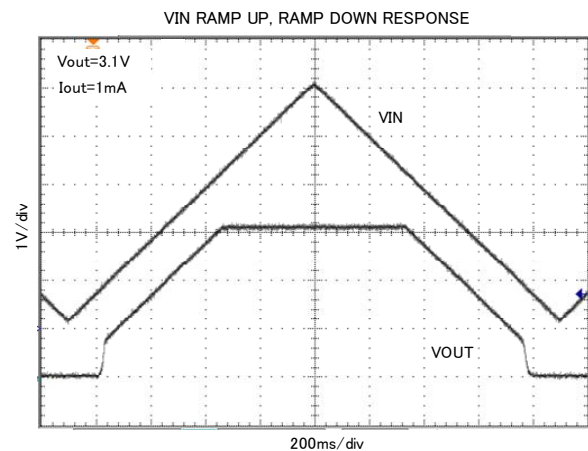

Figure 100.

● Reference data **BU31UA3WNVX** (Ta=25°C unless otherwise specified.)

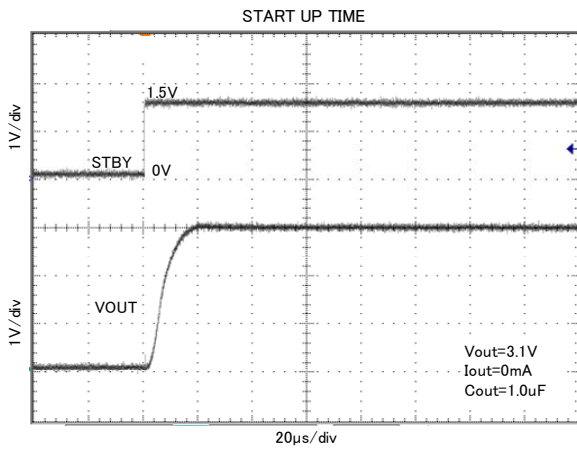

Figure 101.

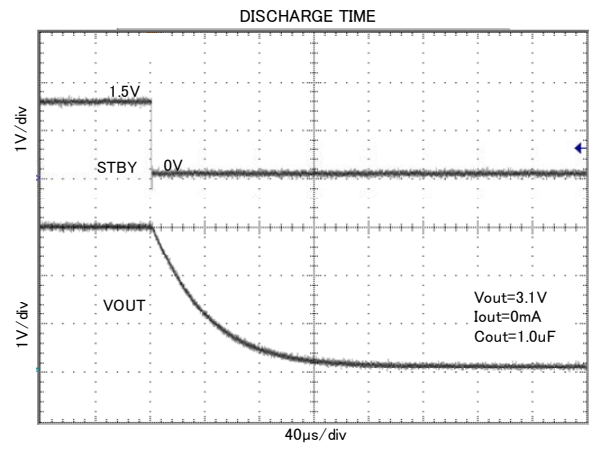

Figure 102.

● About power dissipation (Pd)

As for power dissipation, an approximate estimate of the heat reduction characteristics and internal power consumption of IC are shown, so please use these for reference. Since power dissipation changes substantially depending on the implementation conditions (board size, board thickness, metal wiring rate, number of layers and through holes, etc.), it is recommended to measure Pd on a set board. Exceeding the power dissipation of IC may lead to deterioration of the original IC performance, such as causing operation of the thermal shutdown circuit or reduction in current capability. Therefore, be sure to prepare sufficient margin within power dissipation for usage.

Calculation of the maximum internal power consumption of IC (P_{MAX})

$$P_{MAX} = (V_{IN} - V_{OUT}) \times I_{OUT(MAX)}$$

(V_{IN}: Input voltage V_{OUT}: Output voltage I_{OUT(MAX)}: Maximum output current)

○ Measurement conditions

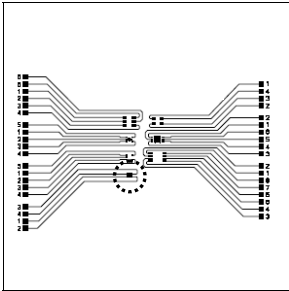
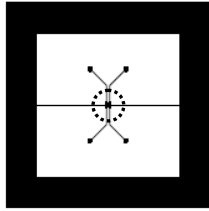
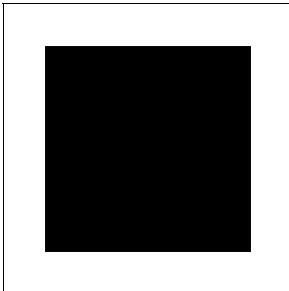
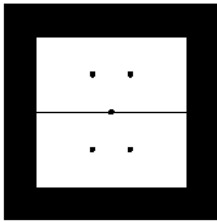
		Standard ROHM Board	Evaluation Board 1
Layout of Board for Measurement			
	IC Implementation Position		
Measurement State		With board implemented (Wind speed 0 m/s)	With board implemented (Wind speed 0 m/s)
Board Material		Glass epoxy resin (Double-side board)	Glass epoxy resin (Double-side board)
Board Size		70 mm x 70 mm x 1.6 mm	40 mm x 40 mm x 1.6 mm
Wiring Rate	Top layer	Metal (GND) wiring rate: Approx. 0%	Metal (GND) wiring rate: Approx. 50%
	Bottom layer	Metal (GND) wiring rate: Approx. 50%	Metal (GND) wiring rate: Approx. 50%
Through Hole		Diameter 0.5mm x 6 holes	Diameter 0.5mm x 25 holes
Power Dissipation		0.56W	0.39W
Thermal Resistance		$\theta_{ja} = 178.6^{\circ}\text{C/W}$	$\theta_{ja} = 256.4^{\circ}\text{C/W}$

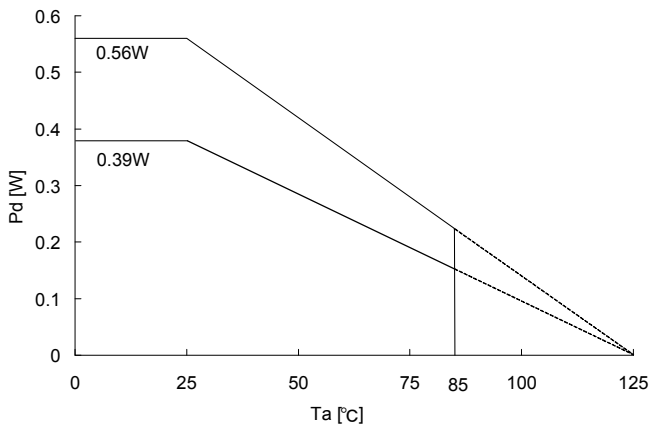

* Please design the margin so that P_{MAX} becomes is than Pd (P_{MAX}<Pd) within the usage temperature range

Figure 103. SSON004X1010 Power dissipation heat reduction characteristics (Reference)

●Operation Notes

1.) Absolute maximum ratings

Use of the IC in excess of absolute maximum ratings (such as the input voltage or operating temperature range) may result in damage to the IC. Assumptions should not be made regarding the state of the IC (e.g., short mode or open mode) when such damage is suffered. If operational values are expected to exceed the maximum ratings for the device, consider adding protective circuitry (such as fuses) to eliminate the risk of damaging the IC.

2.) GND potential

The potential of the GND pin must be the minimum potential in the system in all operating conditions. Never connect a potential lower than GND to any pin, even if only transiently.

3.) Thermal design

Use a thermal design that allows for a sufficient margin for that package power dissipation rating (Pd) under actual operating conditions.

4.) Inter-pin shorts and mounting errors

Use caution when orienting and positioning the IC for mounting on printed circuit boards. Improper mounting or shorts between pins may result in damage to the IC.

5.) Common impedance

Wiring traces should be as short and wide as possible to minimize common impedance. Bypass capacitors should be used to keep ripple to a minimum.

6.) Voltage of STBY pin

To enable standby mode for all channels, set the STBY pin to 0.3 V or less, and for normal operation, to 1.2 V or more. Setting STBY to a voltage between 0.3 and 1.2 V may cause malfunction and should be avoided. Keep transition time between high and low (or vice versa) to a minimum.

Additionally, if STBY is shorted to VIN, the IC will switch to standby mode and disable the output discharge circuit, causing a temporary voltage to remain on the output pin. If the IC is switched on again while this voltage is present, overshoot may occur on the output. Therefore, in applications where these pins are shorted, the output should always be completely discharged before turning the IC on.

7.) Over-current protection circuit (OCP)

This IC features an integrated over-current and short-protection circuitry on the output to prevent destruction of the IC when the output is shorted. The OCP circuitry is designed only to protect the IC from irregular conditions (such as motor output shorts) and is not designed to be used as an active security device for the application. Therefore, applications should not be designed under the assumption that this circuitry will engage.

8.) Thermal shutdown circuit (TSD)

This IC also features a thermal shutdown circuit that is designed to turn the output off when the junction temperature of the IC exceeds about 150°C. This feature is intended to protect the IC only in the event of thermal overload and is not designed to guarantee operation or act as an active security device for the application. Therefore, applications should not be designed under the assumption that this circuitry will engage.

9.) Input/output capacitor

Capacitors must be connected between the input/output pins and GND for stable operation, and should be physically mounted as close to the IC pins as possible. The input capacitor helps to counteract increases in power supply impedance, and increases stability in applications with long or winding power supply traces. The output capacitance value is directly related to the overall stability and transient response of the regulator, and is set to the largest possible value for the application to increase these characteristics. During design, keep in mind that in general, ceramic capacitors have a wide range of tolerances, temperature coefficients and DC bias characteristics, and that their capacitance values tend to decrease over time. Confirm these details before choosing appropriate capacitors for your application. (Please refer the technical note, regarding ceramic capacitor of recommendation)

10.) About the equivalent series resistance (ESR) of a ceramic capacitor

Capacitors generally have ESR (equivalent series resistance) and it operates stably in the ESR-IOUT area shown on the right. Since ceramic capacitors, tantalum capacitors, electrolytic capacitors, etc. generally have different ESR, please check the ESR of the capacitor to be used and use it within the stability area range shown in the right graph for evaluation of the actual application.

Cout=1.0uF Cin=1.0uF Temp=25°C

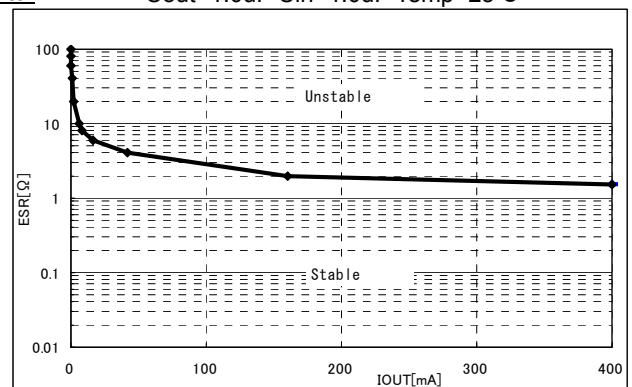

Figure 104. Stable region (example)

●Revision History

Date	Revision	Changes
31.Jan.2013	001	New Release.
20.Feb.2013	002	Package size is changed.
21.Feb.2013	003	Adding a revision history Adding a lineup. The condition of drop voltage is changed.
19.Apr.2013	004	Adding lineup.
28.Jun.2013	005	Adding reference data.
06.Sep.2013	006	Adding Pin Descriptions. Adding BOTTOM VIEW.
05.Feb.2014	007	Adding reference data
10.Oct.2015	008	Lineup is changed.

Notice

Precaution on using ROHM Products

- Our Products are designed and manufactured for application in ordinary electronic equipments (such as AV equipment, OA equipment, telecommunication equipment, home electronic appliances, amusement equipment, etc.). If you intend to use our Products in devices requiring extremely high reliability (such as medical equipment ^(Note 1), transport equipment, traffic equipment, aircraft/spacecraft, nuclear power controllers, fuel controllers, car equipment including car accessories, safety devices, etc.) and whose malfunction or failure may cause loss of human life, bodily injury or serious damage to property ("Specific Applications"), please consult with the ROHM sales representative in advance. Unless otherwise agreed in writing by ROHM in advance, ROHM shall not be in any way responsible or liable for any damages, expenses or losses incurred by you or third parties arising from the use of any ROHM's Products for Specific Applications.

(Note1) Medical Equipment Classification of the Specific Applications

JAPAN	USA	EU	CHINA
CLASS III	CLASS III	CLASS II b	CLASS III
CLASS IV		CLASS III	

- ROHM designs and manufactures its Products subject to strict quality control system. However, semiconductor products can fail or malfunction at a certain rate. Please be sure to implement, at your own responsibilities, adequate safety measures including but not limited to fail-safe design against the physical injury, damage to any property, which a failure or malfunction of our Products may cause. The following are examples of safety measures:
 - Installation of protection circuits or other protective devices to improve system safety
 - Installation of redundant circuits to reduce the impact of single or multiple circuit failure
- Our Products are designed and manufactured for use under standard conditions and not under any special or extraordinary environments or conditions, as exemplified below. Accordingly, ROHM shall not be in any way responsible or liable for any damages, expenses or losses arising from the use of any ROHM's Products under any special or extraordinary environments or conditions. If you intend to use our Products under any special or extraordinary environments or conditions (as exemplified below), your independent verification and confirmation of product performance, reliability, etc. prior to use, must be necessary:
 - Use of our Products in any types of liquid, including water, oils, chemicals, and organic solvents
 - Use of our Products outdoors or in places where the Products are exposed to direct sunlight or dust
 - Use of our Products in places where the Products are exposed to sea wind or corrosive gases, including Cl₂, H₂S, NH₃, SO₂, and NO₂
 - Use of our Products in places where the Products are exposed to static electricity or electromagnetic waves
 - Use of our Products in proximity to heat-producing components, plastic cords, or other flammable items
 - Sealing or coating our Products with resin or other coating materials
 - Use of our Products without cleaning residue of flux (even if you use no-clean type fluxes, cleaning residue of flux is recommended); or Washing our Products by using water or water-soluble cleaning agents for cleaning residue after soldering
 - Use of the Products in places subject to dew condensation
- The Products are not subject to radiation-proof design.
- Please verify and confirm characteristics of the final or mounted products in using the Products.
- In particular, if a transient load (a large amount of load applied in a short period of time, such as pulse. is applied, confirmation of performance characteristics after on-board mounting is strongly recommended. Avoid applying power exceeding normal rated power; exceeding the power rating under steady-state loading condition may negatively affect product performance and reliability.
- De-rate Power Dissipation depending on ambient temperature. When used in sealed area, confirm that it is the use in the range that does not exceed the maximum junction temperature.
- Confirm that operation temperature is within the specified range described in the product specification.
- ROHM shall not be in any way responsible or liable for failure induced under deviant condition from what is defined in this document.

Precaution for Mounting / Circuit board design

- When a highly active halogenous (chlorine, bromine, etc.) flux is used, the residue of flux may negatively affect product performance and reliability.
- In principle, the reflow soldering method must be used on a surface-mount products, the flow soldering method must be used on a through hole mount products. If the flow soldering method is preferred on a surface-mount products, please consult with the ROHM representative in advance.

For details, please refer to ROHM Mounting specification

Precautions Regarding Application Examples and External Circuits

1. If change is made to the constant of an external circuit, please allow a sufficient margin considering variations of the characteristics of the Products and external components, including transient characteristics, as well as static characteristics.
2. You agree that application notes, reference designs, and associated data and information contained in this document are presented only as guidance for Products use. Therefore, in case you use such information, you are solely responsible for it and you must exercise your own independent verification and judgment in the use of such information contained in this document. ROHM shall not be in any way responsible or liable for any damages, expenses or losses incurred by you or third parties arising from the use of such information.

Precaution for Electrostatic

This Product is electrostatic sensitive product, which may be damaged due to electrostatic discharge. Please take proper caution in your manufacturing process and storage so that voltage exceeding the Products maximum rating will not be applied to Products. Please take special care under dry condition (e.g. Grounding of human body / equipment / solder iron, isolation from charged objects, setting of Ionizer, friction prevention and temperature / humidity control).

Precaution for Storage / Transportation

1. Product performance and soldered connections may deteriorate if the Products are stored in the places where:
 - [a] the Products are exposed to sea winds or corrosive gases, including Cl₂, H₂S, NH₃, SO₂, and NO₂
 - [b] the temperature or humidity exceeds those recommended by ROHM
 - [c] the Products are exposed to direct sunshine or condensation
 - [d] the Products are exposed to high Electrostatic
2. Even under ROHM recommended storage condition, solderability of products out of recommended storage time period may be degraded. It is strongly recommended to confirm solderability before using Products of which storage time is exceeding the recommended storage time period.
3. Store / transport cartons in the correct direction, which is indicated on a carton with a symbol. Otherwise bent leads may occur due to excessive stress applied when dropping of a carton.
4. Use Products within the specified time after opening a humidity barrier bag. Baking is required before using Products of which storage time is exceeding the recommended storage time period.

Precaution for Product Label

QR code printed on ROHM Products label is for ROHM's internal use only.

Precaution for Disposition

When disposing Products please dispose them properly using an authorized industry waste company.

Precaution for Foreign Exchange and Foreign Trade act

Since concerned goods might be fallen under listed items of export control prescribed by Foreign exchange and Foreign trade act, please consult with ROHM in case of export.

Precaution Regarding Intellectual Property Rights

1. All information and data including but not limited to application example contained in this document is for reference only. ROHM does not warrant that foregoing information or data will not infringe any intellectual property rights or any other rights of any third party regarding such information or data.
2. ROHM shall not have any obligations where the claims, actions or demands arising from the combination of the Products with other articles such as components, circuits, systems or external equipment (including software).
3. No license, expressly or implied, is granted hereby under any intellectual property rights or other rights of ROHM or any third parties with respect to the Products or the information contained in this document. Provided, however, that ROHM will not assert its intellectual property rights or other rights against you or your customers to the extent necessary to manufacture or sell products containing the Products, subject to the terms and conditions herein.

Other Precaution

1. This document may not be reprinted or reproduced, in whole or in part, without prior written consent of ROHM.
2. The Products may not be disassembled, converted, modified, reproduced or otherwise changed without prior written consent of ROHM.
3. In no event shall you use in any way whatsoever the Products and the related technical information contained in the Products or this document for any military purposes, including but not limited to, the development of mass-destruction weapons.
4. The proper names of companies or products described in this document are trademarks or registered trademarks of ROHM, its affiliated companies or third parties.

General Precaution

1. Before you use our Products, you are requested to carefully read this document and fully understand its contents. ROHM shall not be in any way responsible or liable for failure, malfunction or accident arising from the use of any ROHM's Products against warning, caution or note contained in this document.
2. All information contained in this document is current as of the issuing date and subject to change without any prior notice. Before purchasing or using ROHM's Products, please confirm the latest information with a ROHM sales representative.
3. The information contained in this document is provided on an "as is" basis and ROHM does not warrant that all information contained in this document is accurate and/or error-free. ROHM shall not be in any way responsible or liable for any damages, expenses or losses incurred by you or third parties resulting from inaccuracy or errors of or concerning such information.

Mouser Electronics

Authorized Distributor

Click to View Pricing, Inventory, Delivery & Lifecycle Information:

ROHM Semiconductor:

[BU26UA3WNVX-TL](#) [BU1JUA3WNVX-TL](#) [BU21UA3WNVX-TL](#) [BU13UA3WNVX-TL](#) [BU1AUA3WNVX-TL](#)
[BU19UA3WNVX-TL](#) [BU32UA3WNVX-TL](#) [BU22UA3WNVX-TL](#) [BU2JUA3WNVX-TL](#) [BU29UA3WNVX-TL](#)
[BU28UA3WNVX-TL](#) [BU20UA3WNVX-TL](#) [BU2KUA3WNVX-TL](#) [BU15UA3WNVX-TL](#) [BU33UA3WNVX-TL](#)
[BU2HUA3WNVX-TL](#) [BU2AUA3WNVX-TL](#) [BU1BUA3WNVX-TL](#) [BU25UA3WNVX-TL](#) [BU31UA3WNVX-TL](#)
[BU1CUA3WNVX-TL](#) [BU12UA3WNVX-TL](#) [BU30UA3WNVX-TL](#) [BU37UA3WNVX-TL](#) [BU10UA3WNVX-TL](#)
[BU18UA3WNVX-TL](#) [BU11UA3WNVX-TL](#) [BU34UA3WNVX-TL](#) [BU23UA3WNVX-TL](#) [BU27UA3WNVX-TL](#)