



Is Now Part of



ON Semiconductor®

To learn more about ON Semiconductor, please visit our website at
www.onsemi.com

Please note: As part of the Fairchild Semiconductor integration, some of the Fairchild orderable part numbers will need to change in order to meet ON Semiconductor's system requirements. Since the ON Semiconductor product management systems do not have the ability to manage part nomenclature that utilizes an underscore (_), the underscore (_) in the Fairchild part numbers will be changed to a dash (-). This document may contain device numbers with an underscore (_). Please check the ON Semiconductor website to verify the updated device numbers. The most current and up-to-date ordering information can be found at www.onsemi.com. Please email any questions regarding the system integration to Fairchild_questions@onsemi.com.

ON Semiconductor and the ON Semiconductor logo are trademarks of Semiconductor Components Industries, LLC dba ON Semiconductor or its subsidiaries in the United States and/or other countries. ON Semiconductor owns the rights to a number of patents, trademarks, copyrights, trade secrets, and other intellectual property. A listing of ON Semiconductor's product/patent coverage may be accessed at www.onsemi.com/site/pdf/Patent-Marking.pdf. ON Semiconductor reserves the right to make changes without further notice to any products herein. ON Semiconductor makes no warranty, representation or guarantee regarding the suitability of its products for any particular purpose, nor does ON Semiconductor assume any liability arising out of the application or use of any product or circuit, and specifically disclaims any and all liability, including without limitation special, consequential or incidental damages. Buyer is responsible for its products and applications using ON Semiconductor products, including compliance with all laws, regulations and safety requirements or standards, regardless of any support or applications information provided by ON Semiconductor. "Typical" parameters which may be provided in ON Semiconductor data sheets and/or specifications can and do vary in different applications and actual performance may vary over time. All operating parameters, including "Typicals" must be validated for each customer application by customer's technical experts. ON Semiconductor does not convey any license under its patent rights nor the rights of others. ON Semiconductor products are not designed, intended, or authorized for use as a critical component in life support systems or any FDA Class 3 medical devices or medical devices with a same or similar classification in a foreign jurisdiction or any devices intended for implantation in the human body. Should Buyer purchase or use ON Semiconductor products for any such unintended or unauthorized application, Buyer shall indemnify and hold ON Semiconductor and its officers, employees, subsidiaries, affiliates, and distributors harmless against all claims, costs, damages, and expenses, and reasonable attorney fees arising out of, directly or indirectly, any claim of personal injury or death associated with such unintended or unauthorized use, even if such claim alleges that ON Semiconductor was negligent regarding the design or manufacture of the part. ON Semiconductor is an Equal Opportunity/Affirmative Action Employer. This literature is subject to all applicable copyright laws and is not for resale in any manner.

FAN7346

4-Channel LED Current Balance Controller

Features

- Linear Balance Control for 4-Channel LED Arrays
- Wide LED String Voltage Range: $\leq 100V$
- Wide V_{CC} Voltage: 10.5V to 35V
- External Linear Regulation Switch: MOSFET or BJT
- Internal Voltage Regulator for Feedback
- Monitoring Drain-Source Voltage of External Switch
- Precision Current Accuracy Trimmed to 1.5%
- Supports External PWM Dimming - Positive
- Supports Wide Dimming Ratio: 0.5%~100%
- Adaptive Linear Regulation Method
- Generate Integrated Feedback Signal for Primary Controller (Current Feedback + PWM Dimming)
- High Efficiency by Primary Side Direct Feedback
- Thermal Shutdown (Auto-Recovery)
- Over-Voltage Regulation
- Channel Individual Open-LED Protection
- Channel Individual Short-LED Protection
- Channel Individual Over-Current Protection
- Error Flag Output
- 28-Pin SOIC

Applications

- LED BLU for LCD TV
- LED BLU for LCD Monitor
- LED Lighting

Description

The FAN7346 is an LED current-balance controller that controls 4-LED arrays to maintain equal LED current.

The FAN7346 has a high withstanding voltage, so is suitable for edge-type LED BLU and LED Lighting. To minimize components between primary to secondary, the FAN7346 generates a new integrated feedback signal.

The FAN7346 provides various protections, such as over-voltage regulation, open-LED protection, thermal protection, and drain-source voltage protection of regulating switch (the FAN7346 monitors all LED arrays drain-source voltage for protection). To increase system reliability, FAN7346 applies individual string protection. Because FAN7346 integrates so many functions it reduces overall BOM costs.

LED brightness can be linearly varied up to LED current by applying an external Pulse Width Modulated (PWM) signal to the PWM pin.

The FAN7346 is available in a 28-SOIC package.

Ordering Information

| Part Number | Operating Temperature | Package | Packing Method |
|-------------|-----------------------|--|----------------|
| FAN7346M | -40 to +125°C | 28-Lead, Small-Outline Integrated Circuit (SOIC) | Rail |
| FAN7346MX | | | Tape & Reel |

Block Diagram

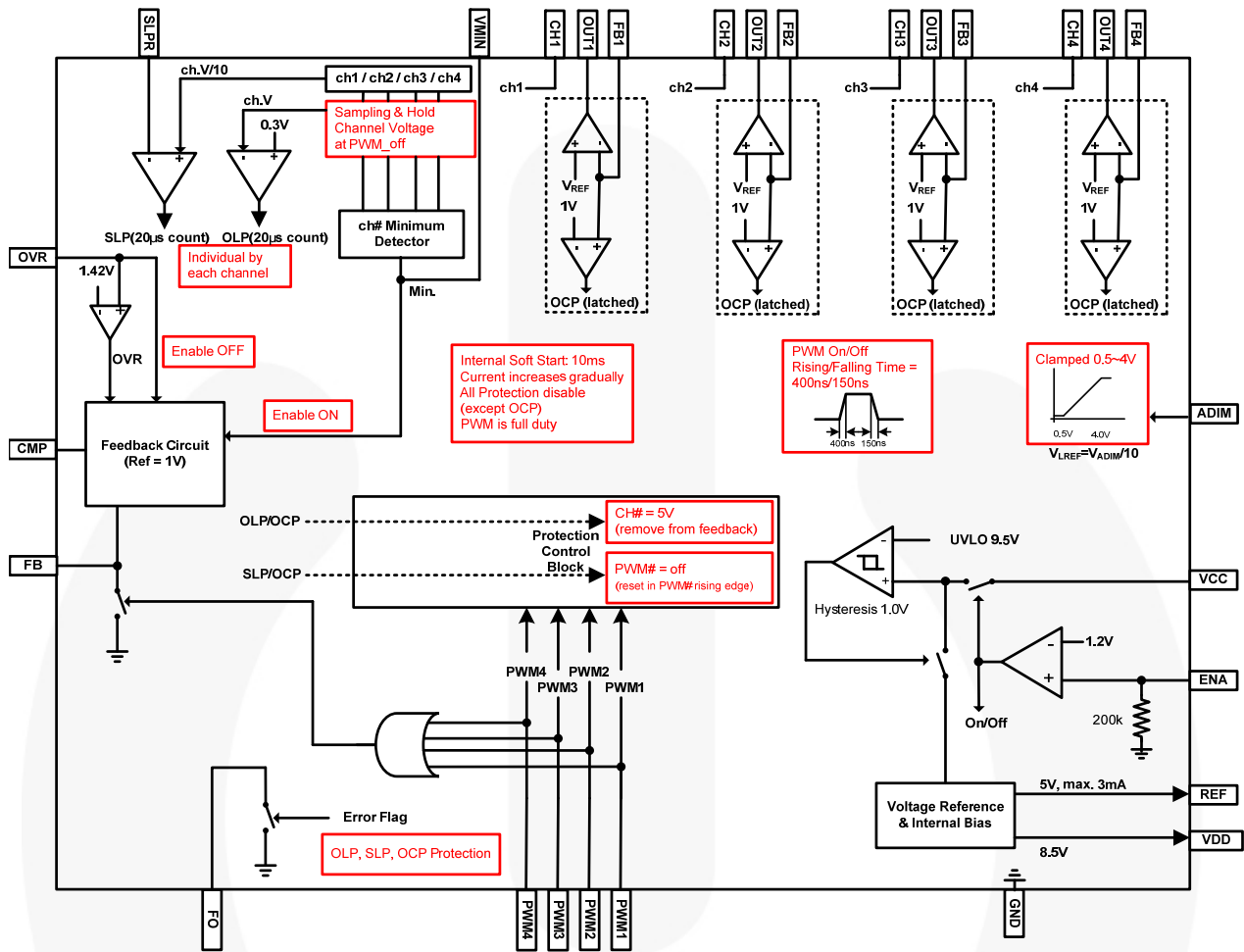

Figure 1. Internal Block Diagram

Pin Configuration

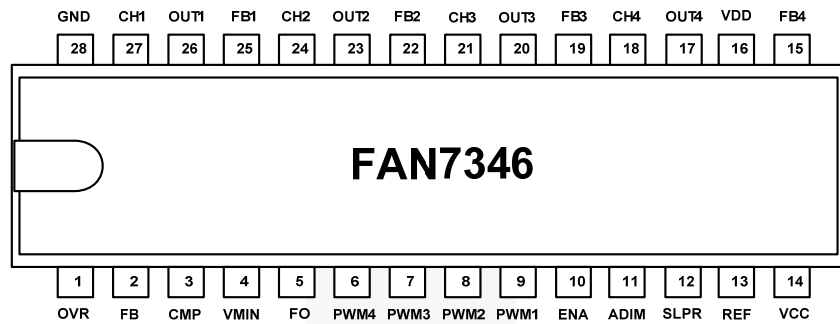

Figure 2. Package Diagram

Pin Definitions

| Pin # | Name | Description |
|-------|------|---|
| 1 | OVR | This pin is input for over-voltage regulation. |
| 2 | FB | This pin is for feedback of minimum drain voltage of external current regulation switch. This pin is externally connected to the cathode of the feedback photo-coupler. |
| 3 | CMP | This pin is for compensation of the minimum channel voltage feedback. |
| 4 | VMIN | Synchronous signal of channel drain-voltage. If multiple controllers are operated, this pin must be tied together. In single operation, this pin must be open. |
| 5 | FO | This pin is fault output. In case of OLP, SLP, and OCP; this pin is connected to ground. |
| 6 | PWM4 | PWM dimming signal input pin of channel 4. |
| 7 | PWM3 | PWM dimming signal input pin of channel 3. |
| 8 | PWM2 | PWM dimming signal input pin of channel 2. |
| 9 | PWM1 | PWM dimming signal input pin of channel 1. |
| 10 | ENA | Enable input. |
| 11 | ADIM | This pin is for the reference voltage of the LED current feedback voltage. |
| 12 | SLPR | This pin is for setting the reference of channel over-voltage protection (short-LED protection). |
| 13 | REF | This pin is the reference output. Voltage is 5V; current capability is 3mA. |
| 14 | VCC | This pin is the supply voltage of the controller. |
| 15 | FB4 | This pin is for current sensing feedback of channel 4. |
| 16 | VDD | Internal gate driver power supply voltage. A large capacitor (1 μ F~2 μ F) must be connected from this pin to ground. |
| 17 | OUT4 | This pin is for gate signal to the external balance FET of channel 4. |
| 18 | CH4 | This pin is for drain voltage of the external balance FET of channel 4. |
| 19 | FB3 | This pin is for current sensing feedback of channel 3. |
| 20 | OUT3 | This pin is for gate signal to the external balance FET of channel 3. |
| 21 | CH3 | This pin is for drain voltage of the external balance FET of channel 3. |
| 22 | FB2 | This pin is for current sensing feedback of channel 2. |
| 23 | OUT2 | This pin is for gate signal to the external balance FET of channel 2. |
| 24 | CH2 | This pin is for drain voltage of the external balance FET of channel 2. |
| 25 | FB1 | This pin is for current sensing feedback of channel 1. |
| 26 | OUT1 | This pin is for gate signal to the external balance FET of channel 1. |
| 27 | CH1 | This pin is for drain voltage of the external balance FET of channel 1. |
| 28 | GND | This pin is the ground. |

Absolute Maximum Ratings

Stresses exceeding the absolute maximum ratings may damage the device. The device may not function or be operable above the recommended operating conditions and stressing the parts to these levels is not recommended. In addition, extended exposure to stresses above the recommended operating conditions may affect device reliability. The absolute maximum ratings are stress ratings only.

| Symbol | Parameter | Min. | Max. | Unit |
|------------------|--|------|------|------|
| V _{IN} | IC Supply Voltage | 10.5 | 35.0 | V |
| T _A | Operating Temperature Range | -40 | +125 | °C |
| T _J | Operating Junction Temperature | | +150 | °C |
| T _{STG} | Storage Temperature Range | -65 | +150 | °C |
| θ _{JA} | Thermal Resistance Junction-Air ^(1,2) | | 70 | °C/W |
| P _D | Power Dissipation | | 1.4 | W |

Notes:

1. Thermal resistance test board. Size: 76.2mm x 114.3mm x 1.6mm (1S0P); JEDEC standard: JESD51-2, JESD51-3.
2. Assume no ambient airflow.

Pin Breakdown Voltage

| Pin # | Name | Value | Unit | Pin # | Name | Value | Unit |
|-------|------|-------|------|-------|------|-------|------|
| 1 | OVR | 6 | V | 15 | FB4 | 6 | V |
| 2 | FB | 6 | | 16 | VDD | 17 | |
| 3 | CMP | 6 | | 17 | OUT4 | 17 | |
| 4 | VMIN | 6 | | 18 | CH4 | 100 | |
| 5 | FO | 6 | | 19 | FB3 | 6 | |
| 6 | PWM4 | 6 | | 20 | OUT3 | 17 | |
| 7 | PWM3 | 6 | | 21 | CH3 | 100 | |
| 8 | PWM2 | 6 | | 22 | FB2 | 6 | |
| 9 | PWM1 | 6 | | 23 | OUT2 | 17 | |
| 10 | ENA | 6 | | 24 | CH2 | 100 | |
| 11 | ADIM | 6 | | 25 | FB1 | 6 | |
| 12 | SLPR | 6 | | 26 | OUT1 | 17 | |
| 13 | REF | 6 | | 27 | CH1 | 100 | |
| 14 | VCC | 35 | | 28 | GND | | |

Electrical Characteristics

For typical values; $T_A = 25^\circ\text{C}$, $V_{IN} = 12\text{V}$, and $-25^\circ\text{C} \leq T_A \leq 85^\circ\text{C}$, unless otherwise specified. Specifications to $-40^\circ\text{C} \sim 125^\circ\text{C}$ are guaranteed by design based on final characterization results.

| Symbol | Parameter | Condition | Min. | Typ. | Max. | Unit |
|--|------------------------------------|--|------|---------------|------|------------------|
| Under-Voltage Lockout Section (UVLO) | | | | | | |
| V_{th} | Start Threshold Voltage | | 8.5 | 9.5 | 10.5 | V |
| V_{thys} | Start Threshold Voltage Hysteresis | | 0.5 | 1.0 | 1.5 | V |
| I_{st} | Startup Current | $V_{IN}=8\text{V}$ | | 100 | 300 | μA |
| I_{op} | Operating Supply Current | $V_{IN}=12\text{V}$, Not Switching | | 1 | 3 | mA |
| ON/OFF Section | | | | | | |
| V_{on} | On-State Input Voltage | | 1.4 | | 5.0 | V |
| V_{off} | Off-Stage Input Voltage | | | | 0.7 | V |
| R_{ENA} | Pull-Down Resistor | | 130 | 200 | 270 | $\text{k}\Omega$ |
| Reference Section (Recommend $1\mu\text{F}$ X7R Capacitor) | | | | | | |
| V_{REF} | 5V Regulation Voltage | $I_{REF}=0\text{mA}$ | 4.9 | 5.0 | 5.1 | V |
| V_{R-LINE} | 5V Line Regulation | $10 \leq V_{IN} \leq 35\text{V}$ | | | 50 | mV |
| V_{R-LOAD} | 5V Load Regulation | $0 \leq I_{REF} \leq 3\text{mA}$ | | | 50 | mV |
| V_{DD} | 8.5V Regulation Voltage | $V_{IN}=12\text{V}$ | 8.0 | 8.5 | 9.0 | V |
| LED Current Section | | | | | | |
| V_{FBX} | CH LED Current Reference Voltage | $V_{ADIM}=2\text{V}$ | 194 | 200 | 206 | mV |
| V_{LREF} | LED Current Reference Voltage | $0.5\text{V} \leq V_{ADIM} \leq 4\text{V}$ | | $V_{ADIM}/10$ | | V |
| $V_{ADIM-CLAMPH}$ | ADIM Voltage HIGH Clamping Voltage | $V_{IN}=12\text{V}$ | 3.84 | 4.00 | 4.16 | V |
| $V_{ADIM-CLAMPL}$ | ADIM Voltage LOW Clamping Voltage | $V_{IN}=12\text{V}$ | 0.45 | 0.50 | 0.55 | |
| B_{CH} | Current Balance Between Channels | $V_{ADIM}=2\text{V}$ | -1.5 | | 1.5 | % |
| Headroom Voltage Feedback Section | | | | | | |
| V_{FBR} | Feedback Reference Voltage | | 0.95 | 1.00 | 1.05 | V |
| I_{leak} | Channel Leakage Current | PWM ON, $V_{CH}=1\text{V}$ | 0 | | 100 | μA |
| | | PWM OFF, $V_{CH}=30\text{V}$ | 0 | | 2 | μA |
| A_V | Open-Loop Gain ⁽³⁾ | $V_{VMIN}=1\text{V}$ | | 65 | | dB |
| G_m | Error Amplifier Transconductance | $V_{VMIN}=1.5\text{V}$ | 140 | 180 | 220 | μmho |
| I_{sin} | Output Sink Current | $V_{VMIN}=0\text{V}$ | 70 | 120 | 170 | μA |
| I_{sur} | Output Source Current | $V_{VMIN}=2\text{V}$ | 70 | 120 | 170 | μA |

Continued on the following page...

Electrical Characteristics (Continued)

For typical values; $T_A = 25^\circ\text{C}$, $V_{IN} = 12\text{V}$, and $-25^\circ\text{C} \leq T_A \leq 85^\circ\text{C}$, unless otherwise specified. Specifications to $-40^\circ\text{C} \sim 125^\circ\text{C}$ are guaranteed by design based on final characterization results.

| Symbol | Parameter | Condition | Min. | Typ. | Max. | Unit |
|----------------------------|---|---|------|------|------|------------------|
| PWM Dimming Section | | | | | | |
| $V_{\text{bdim(ON)}}$ | PWM Dimming On Voltage | | 2 | | 5 | V |
| $V_{\text{bdim(Off)}}$ | PWM Dimming Off Voltage | | 0 | | 0.8 | V |
| f_{bdim} | PWM Dim Input Frequency Range ⁽³⁾ | On Duty Ratio=1% | 100 | | 500 | Hz |
| t_{bdimR} | PWM Dim On Rising Time ⁽³⁾ | Ext. Switch $Q_g=4.3\text{nC}$ | | 400 | | ns |
| t_{bdimF} | PWM Dim Off Falling Time ⁽³⁾ | Ext. Switch $Q_g=4.3\text{nC}$ | | 150 | | ns |
| Soft-Start Section | | | | | | |
| t_{SS} | Soft-Start Time ⁽³⁾ | $V_{\text{OVR}}=1\text{V}$, $I_{\text{LED}}: 0$ to Maximum | | 10 | | ms |
| Protection Section | | | | | | |
| $V_{\text{TH,OVR}}$ | OVR Threshold Voltage | | 1.35 | 1.42 | 1.49 | V |
| $V_{\text{TH,OCF}}$ | OCF Threshold Voltage | | 0.95 | 1.00 | 1.05 | V |
| T_{OCF} | OCF Shutdown Time ⁽³⁾ | | | 10 | | μs |
| $V_{\text{TH,SLP}}$ | SLP Threshold Voltage | $V_{\text{SLPR}}=1\text{V}$ | 9.5 | 10.0 | 10.5 | V |
| $T_{\text{D,SLP}}$ | SLP Delay ⁽³⁾ | | | 20 | | μs |
| $T_{\text{D,OLP}}$ | OLP Delay ⁽³⁾ | | | 20 | | μs |
| $V_{\text{TH,OLP}}$ | OLP Threshold Voltage | | 0.27 | 0.30 | 0.33 | V |
| T_{TRIP} | Internal Thermal Protection Threshold ⁽³⁾ | | | 150 | | $^\circ\text{C}$ |
| T_{TYH} | Internal Thermal Protection Hysteresis ⁽³⁾ | | | 25 | | $^\circ\text{C}$ |
| Output Section | | | | | | |
| V_{GH} | NMOS Gate High Voltage | $V_{\text{IN}}=12\text{V}$ | 8.0 | 8.5 | 9.0 | V |
| V_{GL} | NMOS Gate Low Voltage | $V_{\text{IN}}=12\text{V}$ | | 0 | | V |
| $V_{\text{G,UVLO}}$ | NMOS Gate Voltage with UVLO Activated | $V_{\text{IN}}=7\text{V}$ | | | 0.3 | V |
| $I_{\text{G,SOURCE}}$ | NMOS Gate Drive Source Current | $V_{\text{IN}}=12\text{V}$ | 50 | 150 | 250 | mA |
| $I_{\text{G,SINK}}$ | NMOS Gate Drive Sink Current | $V_{\text{IN}}=12\text{V}$ | 300 | 500 | 700 | mA |

Note:

3. These Parameters, although guaranteed, are not 100% tested in production.

Typical Performance Characteristics

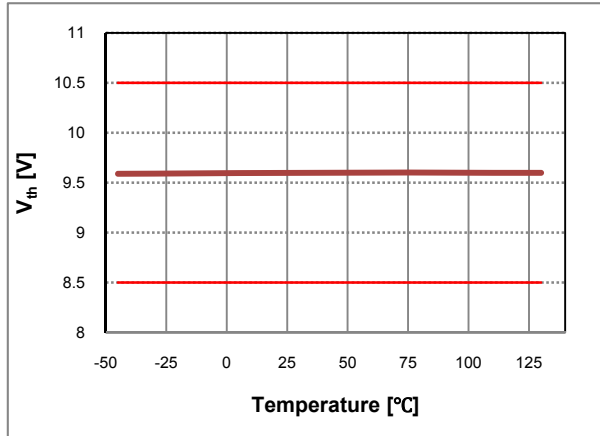

Figure 3. Start Threshold Voltage vs. Temperature

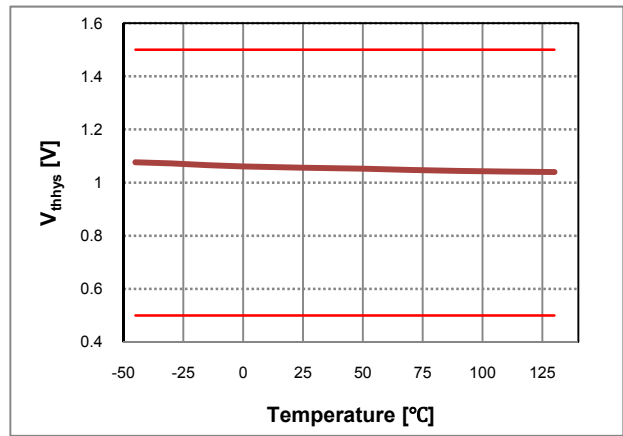

Figure 4. Start Threshold Voltage Hysteresis vs. Temperature

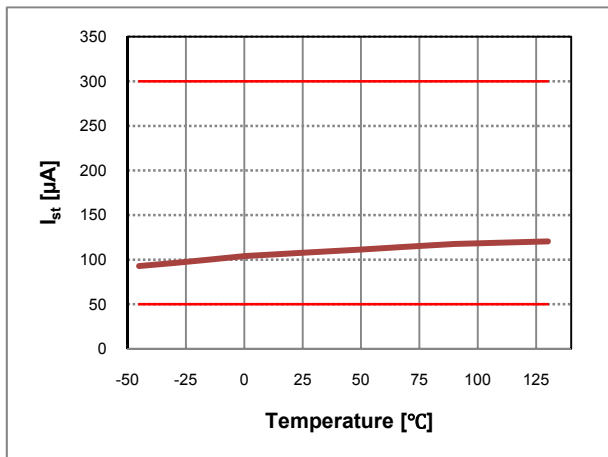

Figure 5. Startup Current vs. Temperature

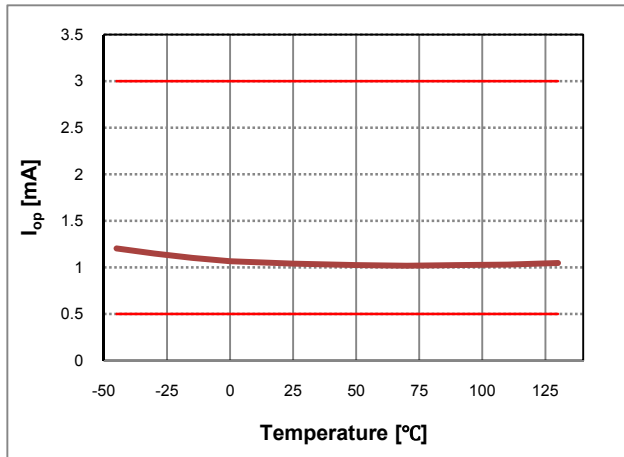

Figure 6. Operating Current vs. Temperature

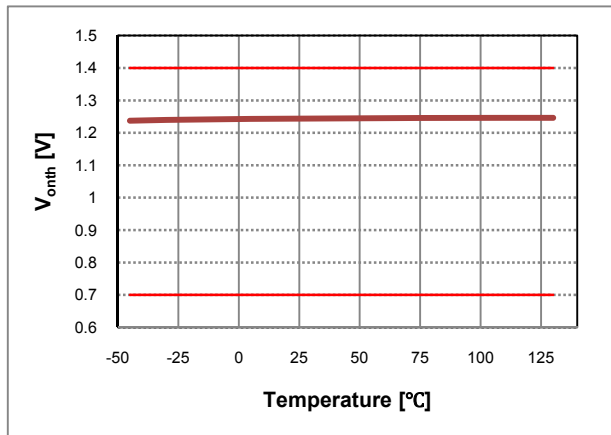

Figure 7. Enable Threshold Voltage vs. Temperature

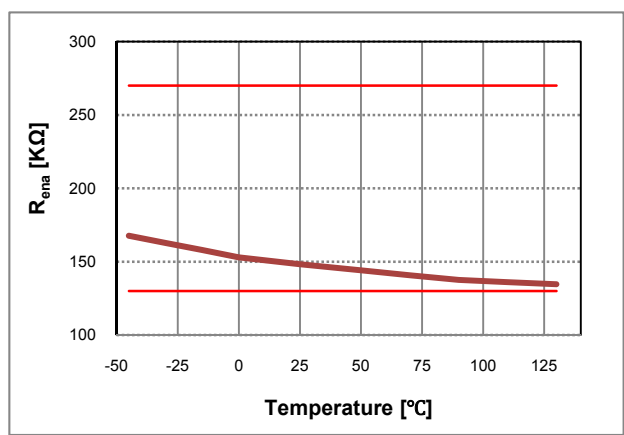

Figure 8. Pull-Down Resistor vs. Temperature

Typical Performance Characteristics (Continued)

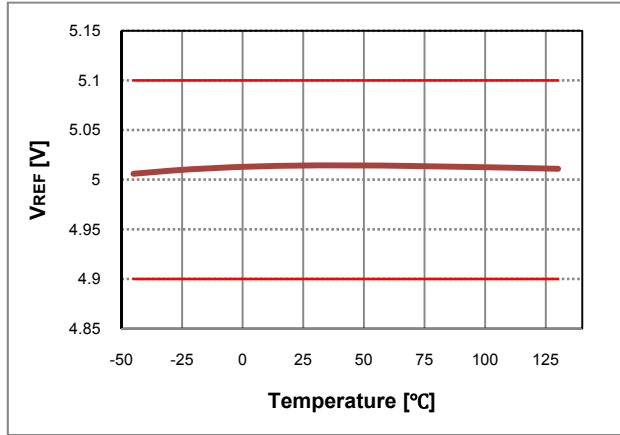

Figure 9. 5V Regulation Voltage vs. Temperature

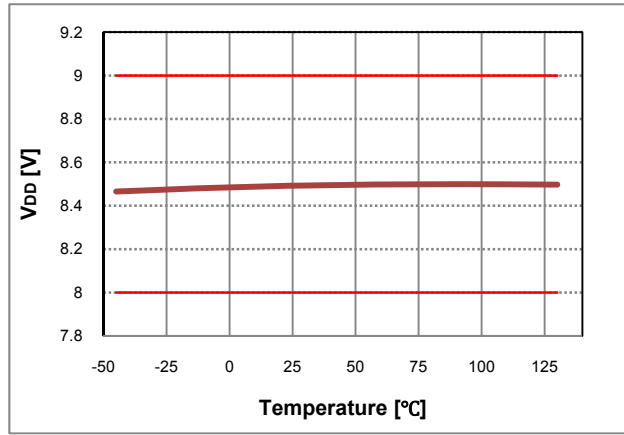

Figure 10. 8.5V Regulation Voltage vs. Temperature

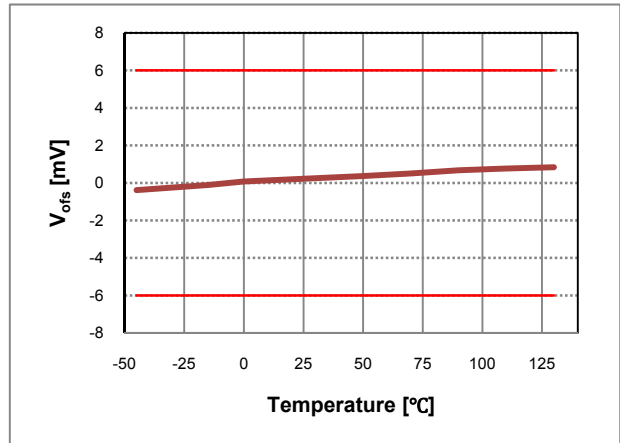

Figure 11. Offset of CH LED Current Reference Voltage vs. Temperature

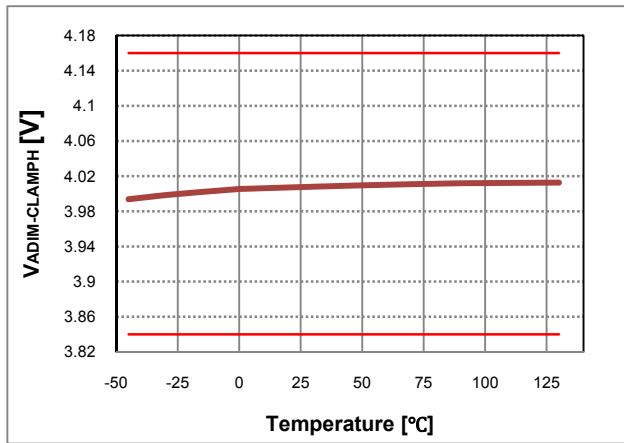

Figure 12. ADIM HIGH Clamping Voltage vs. Temperature

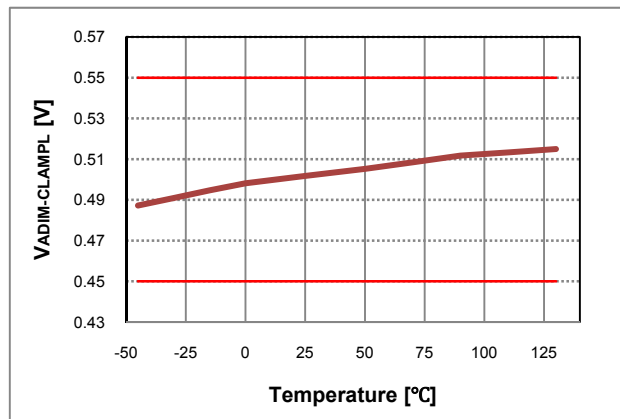

Figure 13. ADIM LOW Clamping Voltage vs. Temperature

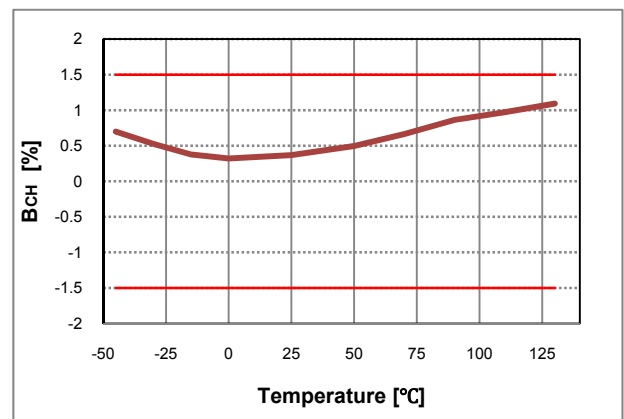

Figure 14. Current Balance Between Channels vs. Temperature

Typical Performance Characteristics (Continued)

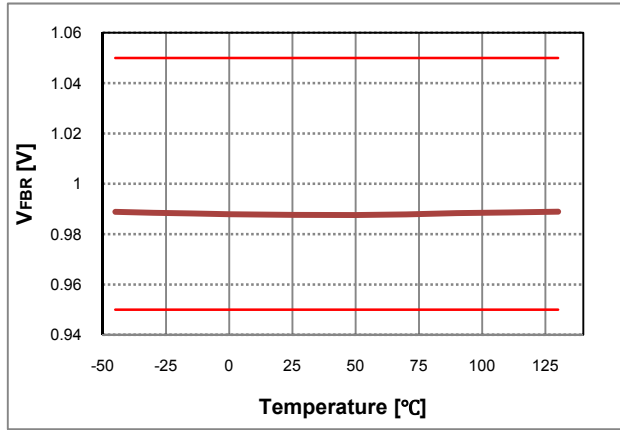

Figure 15. Feedback Reference Voltage vs. Temperature

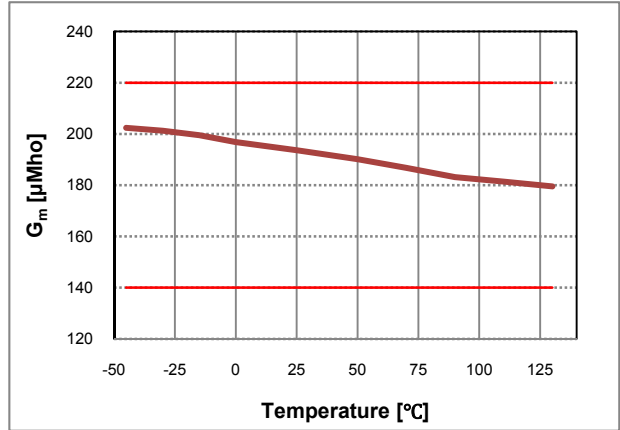

Figure 16. Error Amplifier Transconductance vs. Temperature

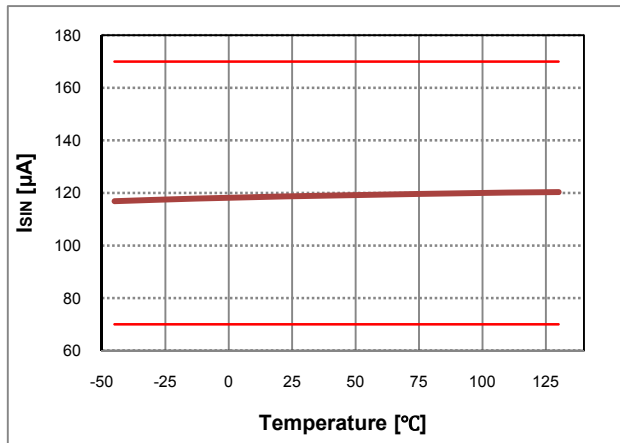

Figure 17. Error Amplifier Output Sink Current vs. Temperature

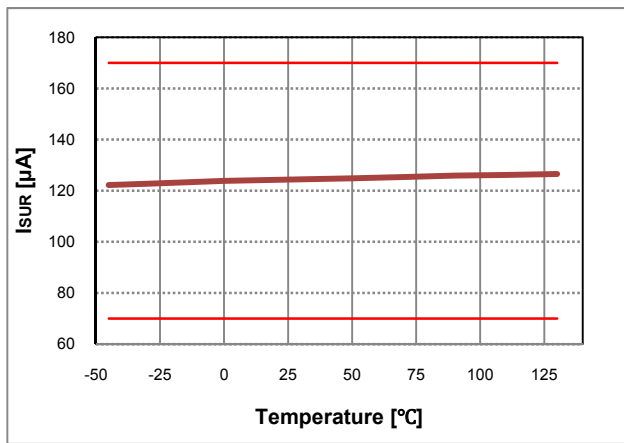

Figure 18. Error Amplifier Output Source current vs. Temperature

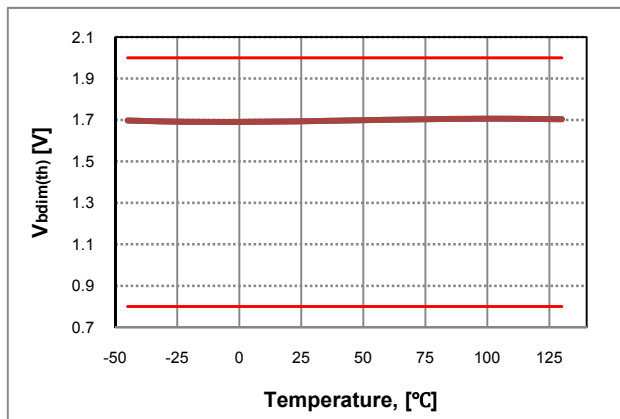

Figure 19. PWM Dimming On Threshold Voltage vs. Temperature

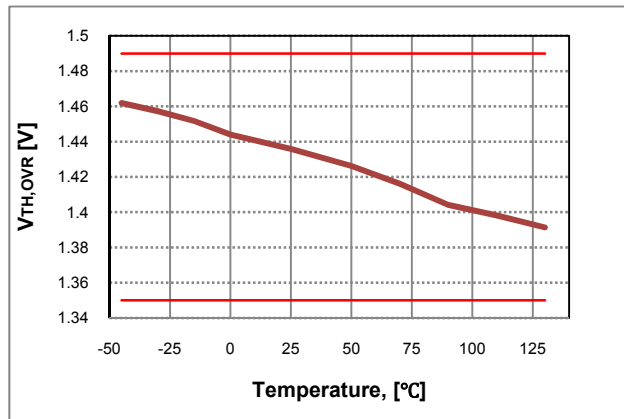

Figure 20. OVR Threshold Voltage vs. Temperature

Typical Performance Characteristics (Continued)

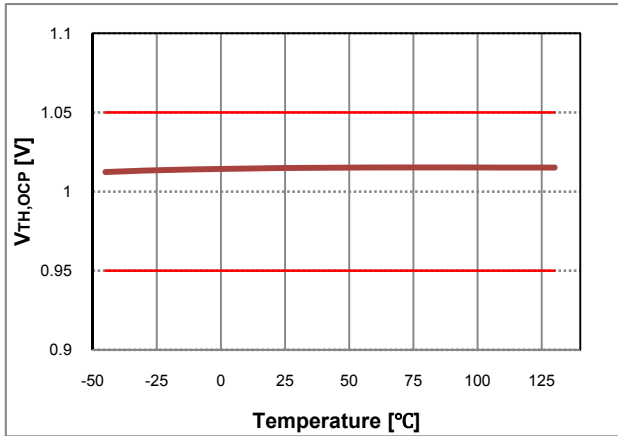

Figure 21. OCP Threshold Voltage vs. Temperature

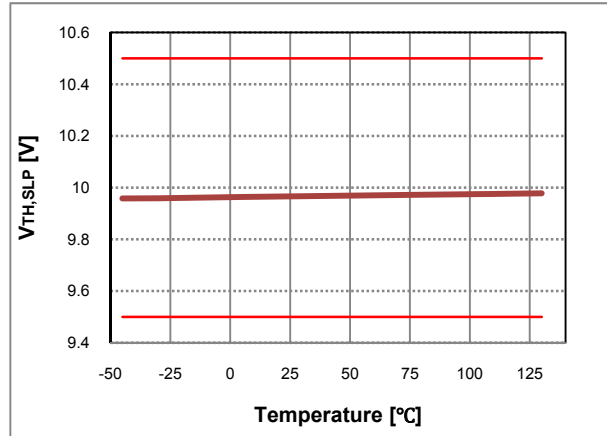

Figure 22. SLP Threshold Voltage vs. Temperature

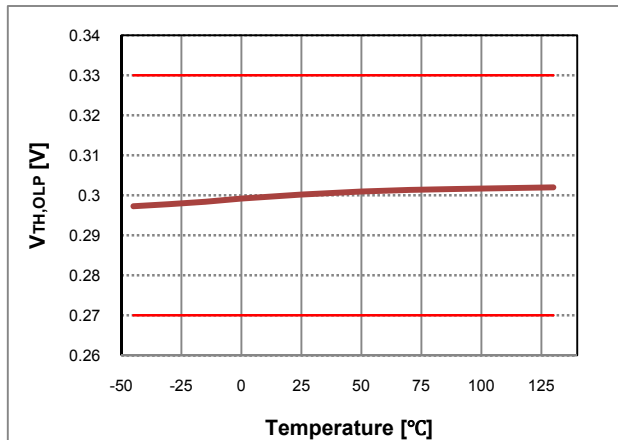

Figure 23. OLP Threshold Voltage vs. Temperature

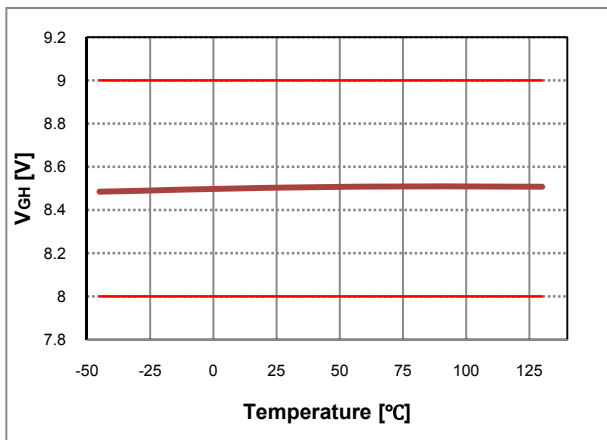

Figure 24. NMOS Gate High Voltage vs. Temperature

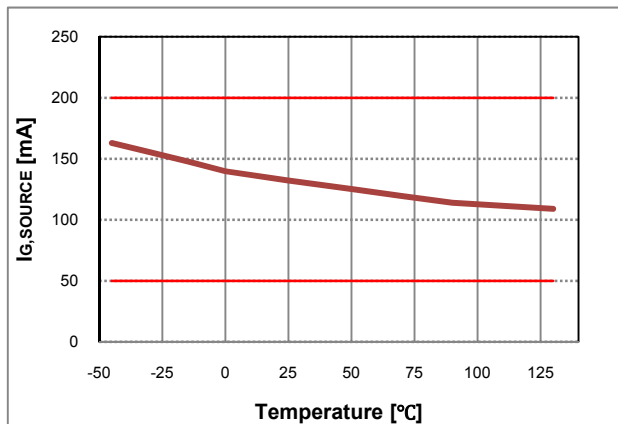

Figure 25. NMOS Gate Drive Source Current vs. Temperature

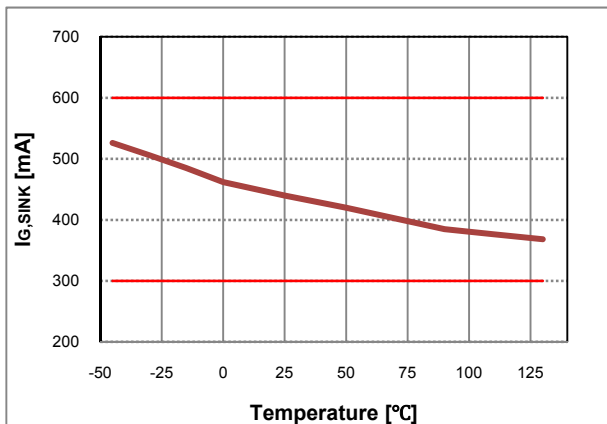

Figure 26. NMOS Gate Drive Sink Current vs. Temperature

Functional Description

The FAN7346 is a high-efficiency 4-channel LED driver. It can drive a 4-channel LED string with four external balance switches. It provides an integrated feedback for a DC-DC controller on the secondary side or on the flyback / LLC controller of the primary side.

Due to the high withstanding voltage of the sensing pin for drain voltage of external switch, the FAN7346 can be used in high-voltage LED string operation without any clamping circuit. Both MOSFET and transistor can be used as external balance switch, so the FAN7346 can drive a high-current LED string.

For four-string operation, the FAN7346 supports four individual PWM signal input pins. The FAN7346 can be operated by parallel connection mode.

For a primary-side direct-power control system, the FAN7346 supports an advanced power sequence and soft-start timing. LED driving voltage can be set before LED ignition for a reliable LED backlight ignition.

The FAN7346 supports various and programmable protections; Short-LED Protection (SLP), Open-LED Protection (OLP), Over-Current Protection (OCP), and Over-Voltage Regulation (OVR). Except OCP, all protection are auto-recovery / auto-restart. Except OVR, all protections are channel-individual protection. In case of SLP, OLP and OCP; even if some strings are in protection condition, other strings continues to operating for higher system reliability.

Figure 27 shows the work-flow of startup sequence.

1. Startup

When V_{CC} voltage is higher than UVLO threshold voltage, internal 5V regulation output is operated. At the same time, feedback starts to control OVR voltage as 1V. If OVR voltage is lower than 1V, feedback is pulled up. If OVR voltage is higher than 1V, feedback is pulled down.

After enable is applied, the FAN7346 begins soft-start procedure. The FAN7346 checks if OVR voltage is higher than 0.9V. If OVR voltage is lower than 0.9V, soft-start function is not started. If OVR voltage is higher than 0.9V, the FAN7346 starts LED current balance and soft-start. The LED current of each string is increased gradually for 10ms, which is fixed soft-start timing. During soft-start timing, SLP and OLP are disabled.

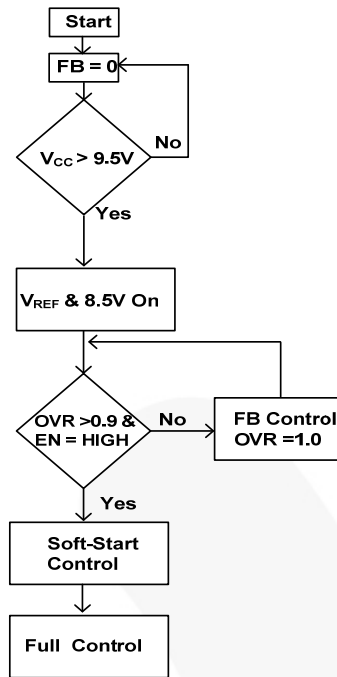

Figure 27. Startup Sequence

2. Feedback

After soft-start, the FAN7346 starts feedback drain-voltage of external balance switch.

Drain voltage of each channel is sensed on the CHx pin. CHx means any of the CH1 / CH2 / CH3 / CH4 pins. Minimum drain voltage is selected between four CHx voltages. The FAN7346 feeds back drain voltage to control minimum drain voltage at 1V.

If minimum drain voltage is higher than 1V, FB is pulled LOW. If minimum drain voltage is lower than 1V, FB is pulled HIGH.

Feedback response can be controlled by adding a resistor and capacitor to the CMP pin.

3. Analog Dimming

In the FAN7346, LED current can be modified by changing ADIM voltage.

LED current is controlled by the FBx pin voltage. FBx means any of the FB1 / FB2 / FB3 / FB4 pins. External current balance switch is operating in the saturation region to control LED current. Sensed voltage on the FBx pin is compared with internal reference voltage and the controller supplies a gate / base signal for the external current balance switch.

Internal reference voltage is decided by ADIM voltage. The formula for LED current calculation is:

$$I_{LED} = \frac{V_{ADIM}}{10 \times R_{SENSE}} \quad (1)$$

ADIM voltage is clamped internally from 0.5V to 4V. If ADIM voltage is lower than 0.5V, it is clamped as 0.5V. If ADIM voltage is higher than 4V, it is clamped as 4V.

4. PWM Dimming

The FAN7346 has four PWM dimming signal pins. Each PWM dimming pin controls an LED string.

If PWM dimming voltage is higher than 2V, an external balance switch is turned on and conducts constant current operation. If PWM dimming voltage is lower than 0.8V, an external balance switch is turned off and blocks LED current.

During PWM dimming off, open-LED protection and short-LED protection is disabled.

CHx drain voltage is sampled during PWM dimming on and held during PWM dimming off to maintain drain voltage regardless of dimming on/off signal.

5. Short-LED Protection (SLP)

To sense a short-LED condition, the FAN7346 uses the drain voltage of external balance switch. If some LEDs are shorted, its LED forward voltage is lower than other LED strings, so the drain voltage of the external balance switch is higher than other drain voltage.

SLP threshold voltage can be programmed by SLPR (Short-LED Protection Reference) voltage. Internal SLP threshold voltage is calculated as:

$$V_{SLP_TH} = 10 * V_{SLPR} \quad (2)$$

Minimum SLP threshold voltage is 0V and maximum SLP threshold voltage is 45V.

SLP is a channel-individual protection. If any string is in SLP condition, the SLP strings is turned off and other string operate normally.

If the sensed-drain voltage (CHx voltage) is higher than the programmed threshold voltage for 20μs, CHx goes into short-LED protection, which forces the corresponding channel to turn off. To increase reliability, the SLP channel is restarted in the next PWM dimming signal rising timing. After restarting, the FAN7346 checks the drain voltage. If the drain voltage is higher than the SLP threshold voltage for 20μs, the switch is turned off. If drain voltage is lower, the channel is restored to normal operation. Shorted LED channel operation is minimum duty PWM dimming with a 20μs dimming on period. During 100% full duty PWM dimming, auto restart is not activated.

Figure 28 shows the SLP operation. As soon as SLPR*10 (blue line) is lower than CHx voltage, CHx is forced into minimum duty dimming operation.

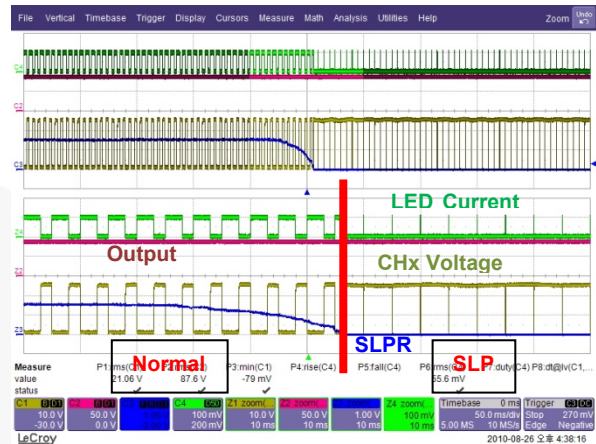

Figure 28. Short-LED Protection Operation

6. Open LED Protection (OLP)

To sensing open-LED condition, the FAN7346 use the drain voltage of an external balance switch. If an LED string is open, the drain voltage of external balance switch is grounded, and the FAN7346 can detect open-LED condition. OLP threshold voltage is 0.3V.

If CHx voltage is lower than 0.3V for 20μs, its drain-voltage feedback is pulled up to 5V. This means the open LED string is eliminated from minimum drain voltage feedback loop. Without OLP, if minimum drain voltage is 0V, drain voltage feedback forces the FB signal to increase output power. This can cause SLP or thermal stress in other channels.

OLP is an auto-recovery protection. As soon as drain voltage is higher than 0.3V, OLP is finished and the drain voltage feedback system is restored.

Figure 29 shows the OLP operation. Before open CH2, CH2 is the headroom channel. (CH2 drain voltage is minimum voltage – 1V.) As soon as open CH2, its drain voltage is 0V, OLP is activated, and CH2 is removed from headroom feedback control loop. CH1 is selected as minimum drain voltage channel, so its drain voltage is controlled as 1V. Reconnecting CH2 string, restores normal operation.

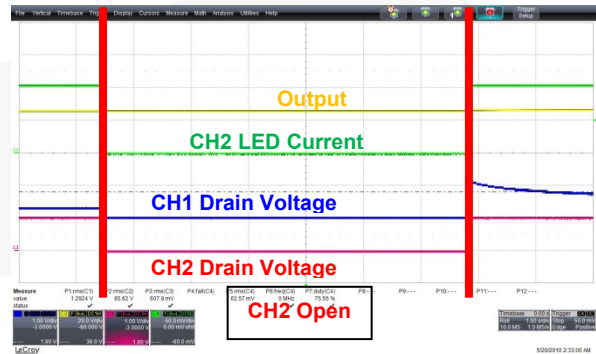

Figure 29. Open-LED Protection Operation

7. Over-Voltage Regulation (OVR)

To prevent LED driving voltage from exceeding the withstanding voltage of system components, the FAN7346 controls LED driving voltage with OVR pin voltage. The FAN7346 senses output LED driving voltage through the OVR pin voltage. Resistor divided output voltage is applied to the OVR pin voltage.

In FAN7346, OVR voltage uses two kinds of feedback and control: and regulating output voltage during enable off and clamping output voltage during enable on.

When ENA pin is LOW, the FAN7346 controls FB voltage to maintain OVR voltage as 1.0V. Through this output voltage control during ENA off, the FAN7346 reaches adequate LED driving voltage before turning ENA on.

After ENA pin is HIGH, OVR pin voltage is used for over-voltage regulation. If OVR pin voltage is lower than 1.42V, the FB pin voltage follows headroom control to maintain minimum voltage of drain voltages as 1V. If OVR pin voltage is higher than 1.42V, the FAN7346 controls FB (FB is pulled LOW). Through feedback regulation, OVR pin voltage cannot exceed 1.42V.

8. Over-Current Protection (OCP)

Through over-current protection, the FAN7346 can protect external balance switches from shorted over-

current damage. To sense over-current condition, the FAN7346 monitors FBx (FB1~FB4) pin voltage.

If FBx voltage is higher than 1V for 20 μ s, CHx is considered an over-current condition. After sensing OCP condition, CHx dimming switch is turned off.

OCP is channel individual and latched protection. If one channel is in OCP condition, other channels keep operating. OCP channel is restarted after UVOL is reset.

9. Error Flag (FO)

To make error flag signal, the FAN7346 uses the FO pin. FO pin is open-drain type.

During normal operation, the FO pin is open. If using an external pull-up resistor, this signal is HIGH.

If used OLP / OCP / SLP protection, the FO pin is connected to ground. If using an external pull-up resistor, this signal is LOW.

If a single channel is in protection condition, error-flag signal is detected. Only if all channels are operating normally is the FO pin pulled HIGH.

Short Lamp Protection

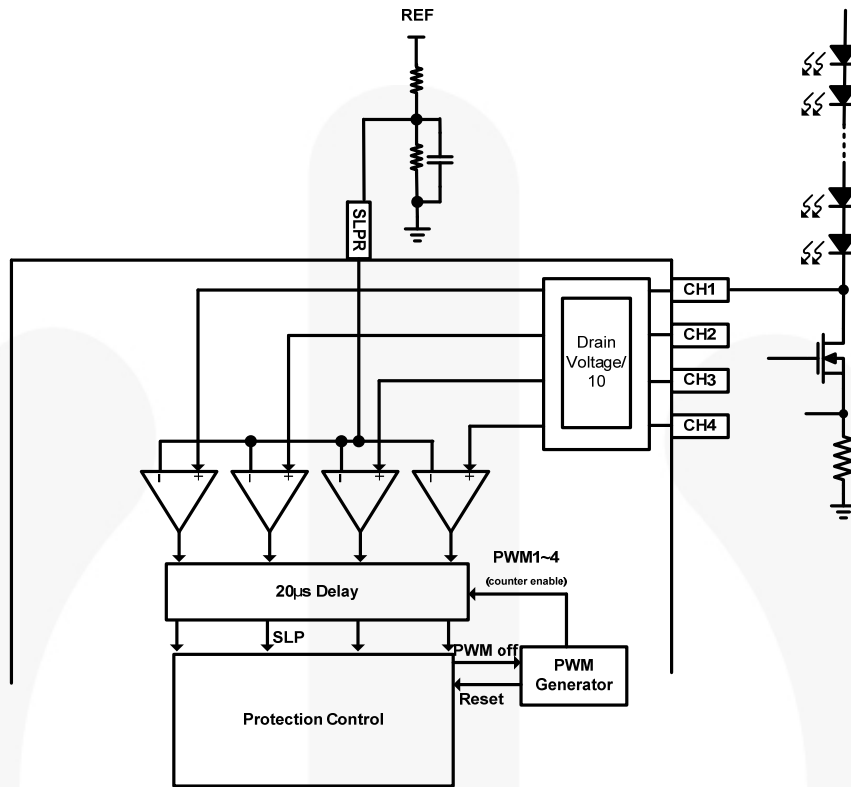

Figure 30. Block Diagram of Short LED Protection

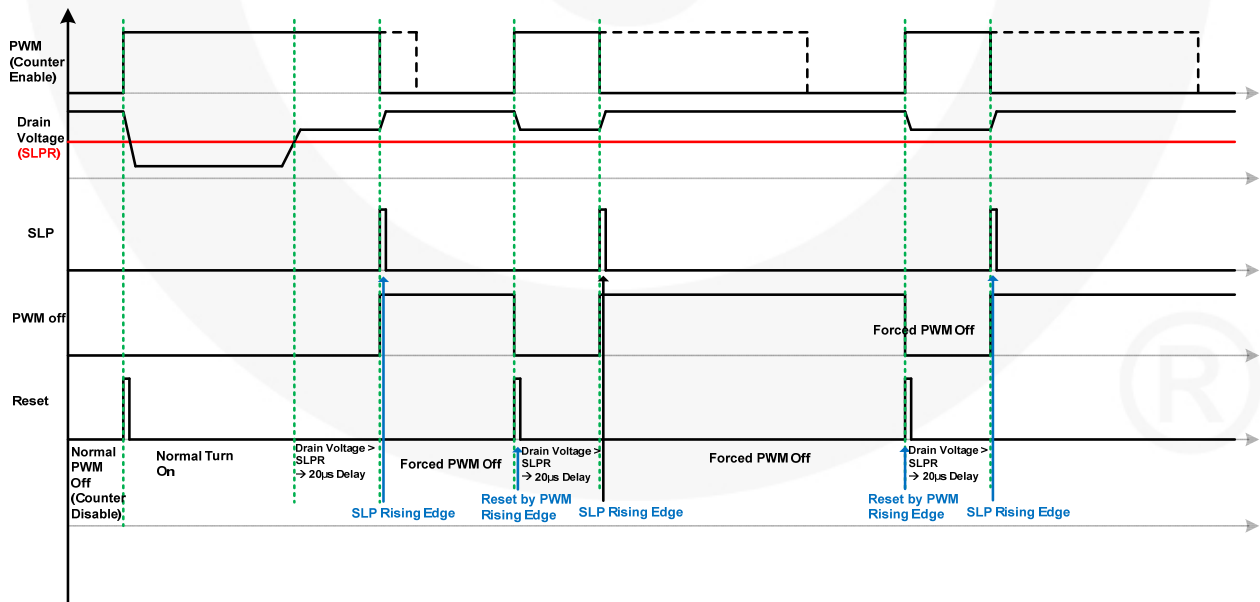

Figure 31. Timing Diagram of Short LED Protection

Typical Application Circuit (Backlight)

| Application | Device | Input Voltage Range | LED String |
|-------------------|---------|---------------------|------------------------|
| 32~46 Inch LED TV | FAN7346 | 380V | 8-String / 90V / 100mA |

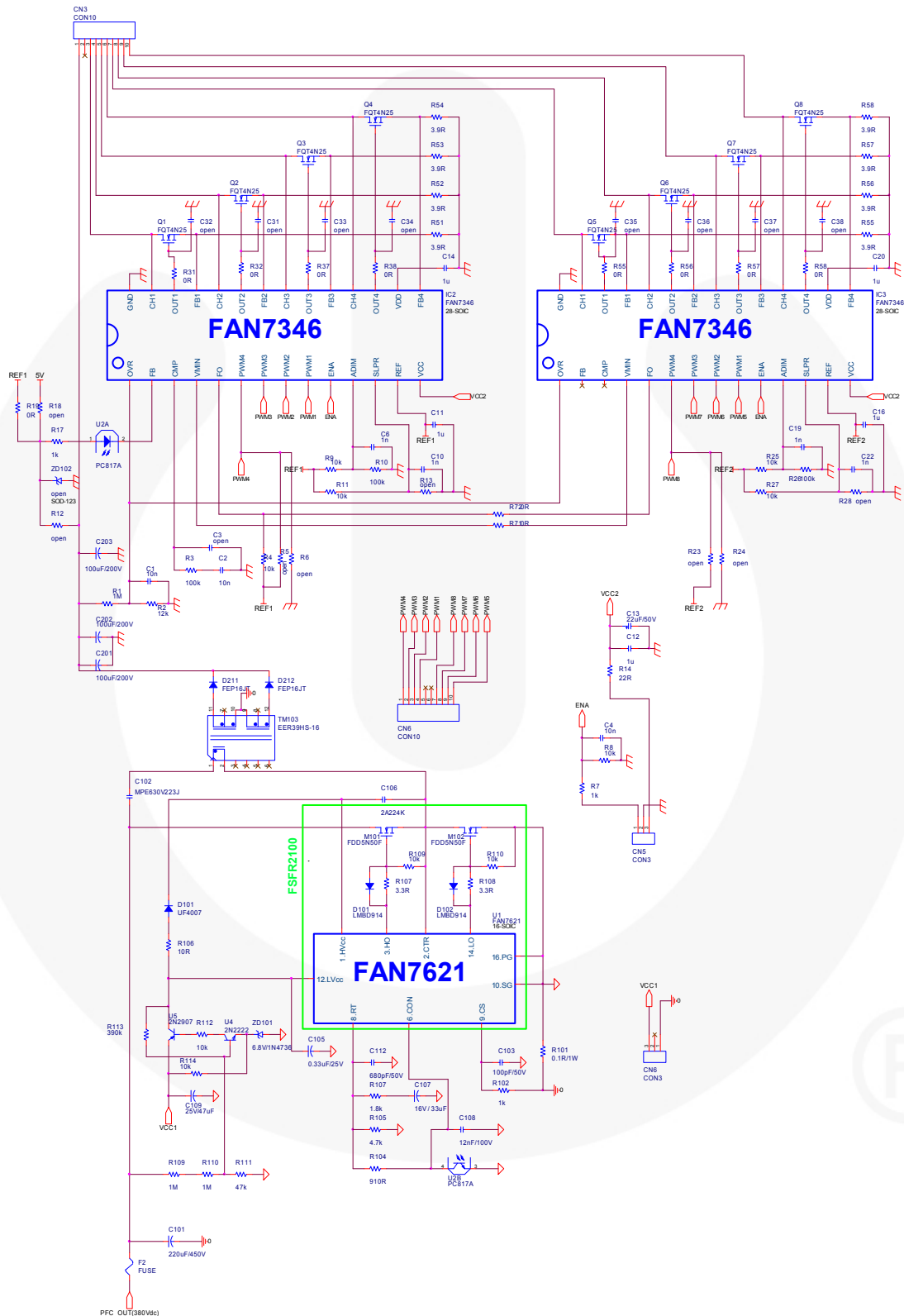

Figure 32. LCD Backlight Driver

Typical Application Circuit (Lighting) (Continued)

| Application | Device | Input Voltage Range | LED String |
|--------------|---------|---------------------|------------|
| LED Lighting | FAN7346 | 380V | 4-String |

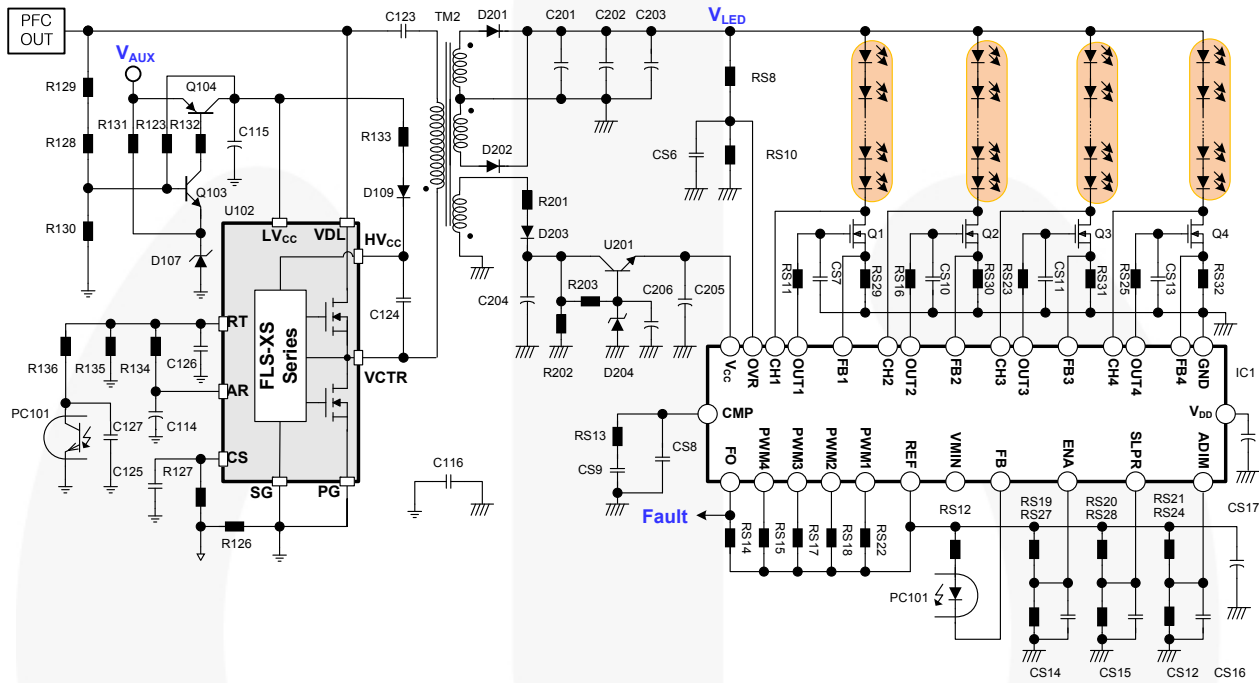

Figure 33. LED Lighting Driver

Typical Application Circuit (Continued)

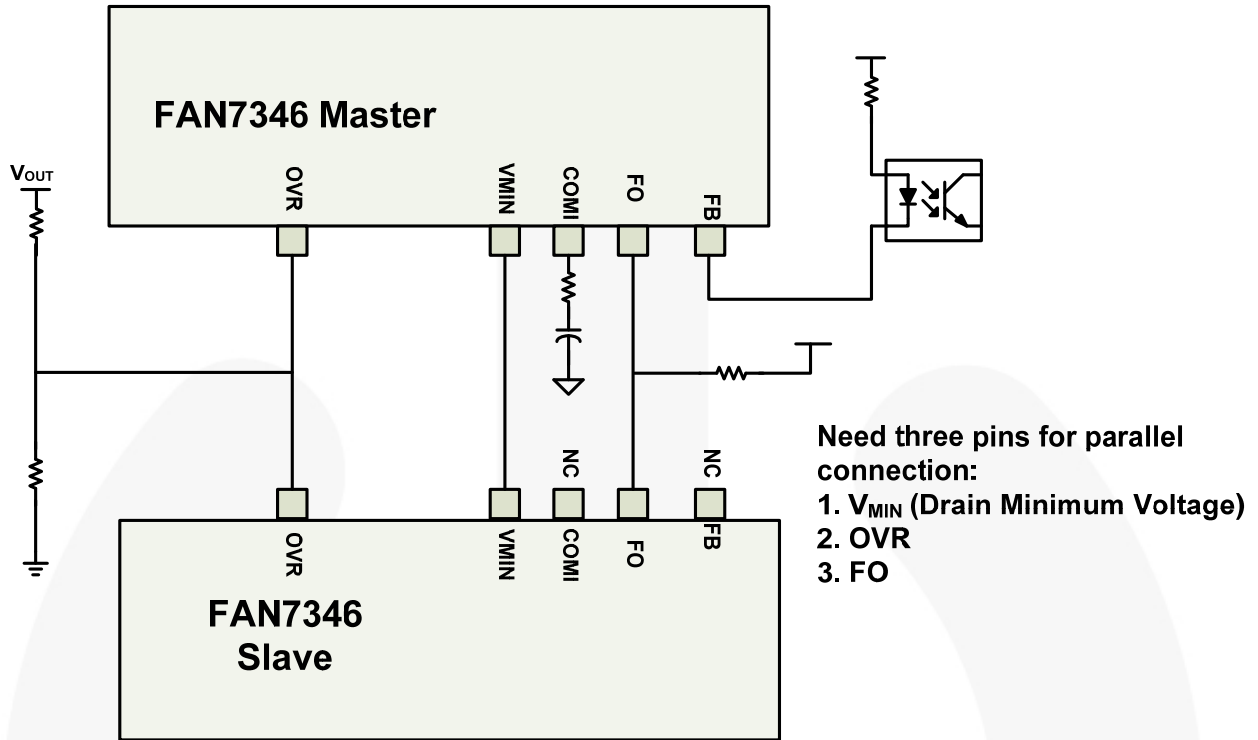

Figure 34. Multiple Controller Driving

Physical Dimensions

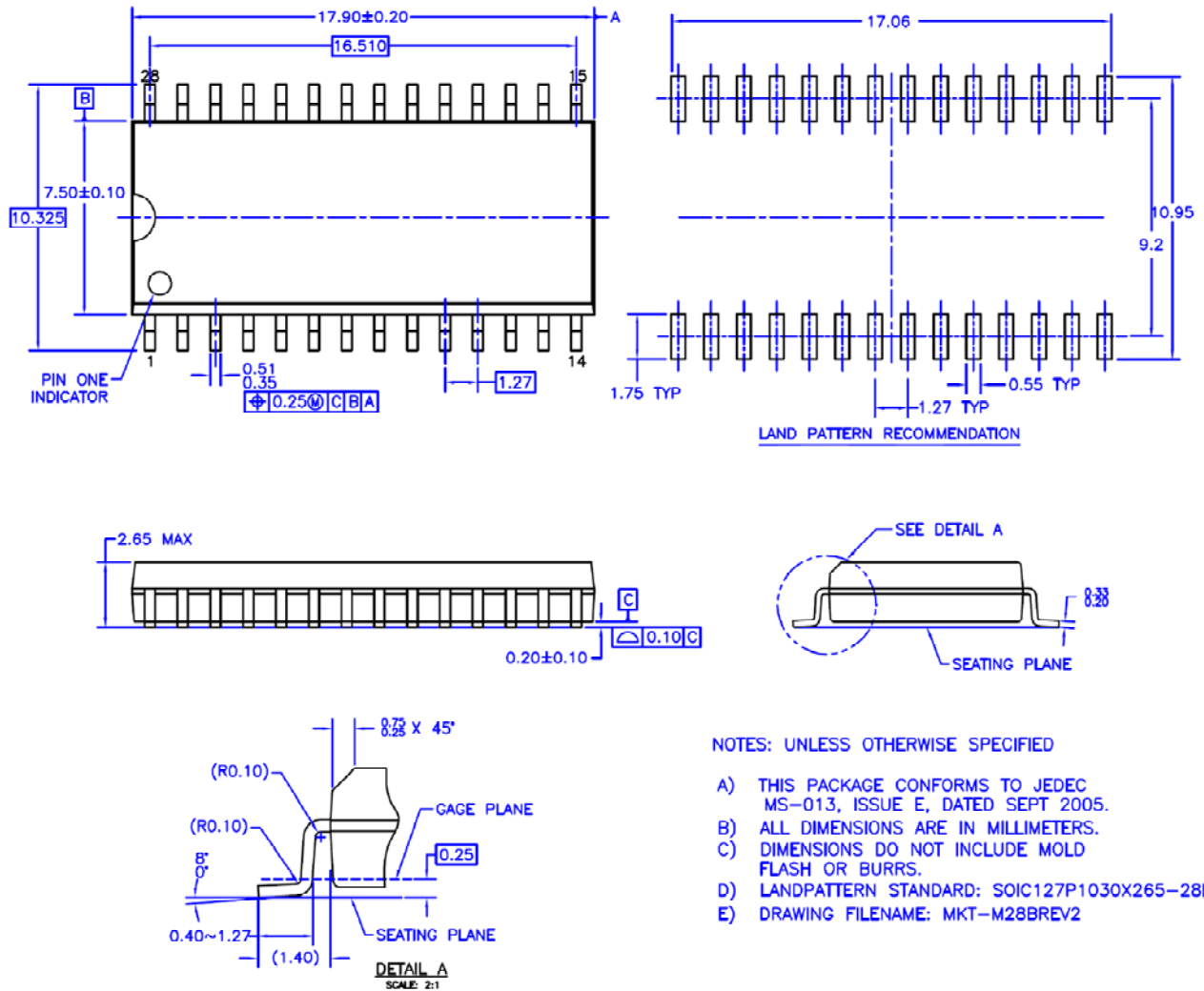

Figure 35. 28-Lead, Small-Outline Integrated Circuit (SOIC), JEDEC MS-013, 0.300-Inch, Wide Body





Package drawings are provided as a service to customers considering Fairchild components. Drawings may change in any manner without notice. Please note the revision and/or date on the drawing and contact a Fairchild Semiconductor representative to verify or obtain the most recent revision. Package specifications do not expand the terms of Fairchild's worldwide terms and conditions, specifically the warranty therein, which covers Fairchild products.

Always visit Fairchild Semiconductor's online packaging area for the most recent package drawings:
<http://www.fairchildsemi.com/packaging/>



TRADEMARKS

The following includes registered and unregistered trademarks and service marks, owned by Fairchild Semiconductor and/or its global subsidiaries, and is not intended to be an exhaustive list of all such trademarks.

- | | | | |
|---|---|---|---|
| AccuPower™ | FPS™ | Power-SPM™ | The Power Franchise® |
| Auto-SPM™ | F-PFST™ | PowerTrench® | The Right Technology for Your Success™ |
| AX-CAP™ | FRFET® | PowerXST™ | the power franchise |
| BitSiC® | Global Power Resource™ | Programmable Active Droop™ | TinyBoost™ |
| Build it Now™ | Green FPS™ | QFET® | TinyBuck™ |
| CorePLUS™ | Green FPS™ e-Series™ | QS™ | TinyCalc™ |
| CorePOWER™ | Gmax™ | Quiet Series™ | TinyLogic® |
| CROSSVOLT™ | GTO™ | RapidConfigure™ | TINYOPTO™ |
| CTL™ | IntelliMAX™ |  | TinyPower™ |
| Current Transfer Logic™ | ISOPANAR™ | Saving our world, 1mW/W/kW at a time™ | TinyPWM™ |
| DEUXPEED® | MegaBuck™ | SignalWise™ | TinyWire™ |
| Dual Cool™ | MICROCOUPLER™ | SmartMax™ | TranSiC® |
| EcoSPARK® | MicroFET™ | SMART START™ | TriFault Detect™ |
| EfficientMax™ | MicroPak™ | SPM® | TRUECURRENT® |
| ESBC™ | MicroPak2™ | STEALTH™ | µSerDes™ |
|  | MillerDrive™ | SuperFET® |  |
| Fairchild® | MotionMax™ | SuperSOT™-3 | UHC® |
| Fairchild Semiconductor® | Motion-SPM™ | SuperSOT™-6 | Ultra FRFET™ |
| FACT Quiet Series™ | mWSaver™ | SuperSOT™-8 | UniFET™ |
| FACT® | OptoHiT™ | SupreMOS® | VCX™ |
| FAST® | OPTOLOGIC® | SyncFET™ | VisualMax™ |
| FastvCore™ | OPTOPLANAR® | Sync-Lock™ | XST™ |
| FETBench™ |  | | |
| FlashWriter® | PDP SPM™ | | |

* Trademarks of System General Corporation, used under license by Fairchild Semiconductor.

DISCLAIMER

FAIRCHILD SEMICONDUCTOR RESERVES THE RIGHT TO MAKE CHANGES WITHOUT FURTHER NOTICE TO ANY PRODUCTS HEREIN TO IMPROVE RELIABILITY, FUNCTION, OR DESIGN. FAIRCHILD DOES NOT ASSUME ANY LIABILITY ARISING OUT OF THE APPLICATION OR USE OF ANY PRODUCT OR CIRCUIT DESCRIBED HEREIN, NEITHER DOES IT CONVEY ANY LICENSE UNDER ITS PATENT RIGHTS, NOR THE RIGHTS OF OTHERS. THESE SPECIFICATIONS DO NOT EXPAND THE TERMS OF FAIRCHILD'S WORLDWIDE TERMS AND CONDITIONS, SPECIFICALLY THE WARRANTY THEREIN, WHICH COVERS THESE PRODUCTS.

LIFE SUPPORT POLICY

FAIRCHILD'S PRODUCTS ARE NOT AUTHORIZED FOR USE AS CRITICAL COMPONENTS IN LIFE SUPPORT DEVICES OR SYSTEMS WITHOUT THE EXPRESS WRITTEN APPROVAL OF FAIRCHILD SEMICONDUCTOR CORPORATION.

As used herein:

1. Life support devices or systems are devices or systems which, (a) are intended for surgical implant into the body or (b) support or sustain life, and (c) whose failure to perform when properly used in accordance with instructions for use provided in the labeling, can be reasonably expected to result in a significant injury of the user.
2. A critical component in any component of a life support, device, or system whose failure to perform can be reasonably expected to cause the failure of the life support device or system, or to affect its safety or effectiveness.

ANTI-COUNTERFEITING POLICY

Fairchild Semiconductor Corporation's Anti-Counterfeiting Policy. Fairchild's Anti-Counterfeiting Policy is also stated on our external website, www.fairchildsemi.com, under Sales Support.

Counterfeiting of semiconductor parts is a growing problem in the industry. All manufacturers of semiconductor products are experiencing counterfeiting of their parts. Customers who inadvertently purchase counterfeit parts experience many problems such as loss of brand reputation, substandard performance, failed applications, and increased cost of production and manufacturing delays. Fairchild is taking strong measures to protect ourselves and our customers from the proliferation of counterfeit parts. Fairchild strongly encourages customers to purchase Fairchild parts either directly from Fairchild or from Authorized Fairchild Distributors who are listed by country on our web page cited above. Products customers buy either from Fairchild directly or from Authorized Fairchild Distributors are genuine parts, have full traceability, meet Fairchild's quality standards for handling and storage and provide access to Fairchild's full range of up-to-date technical and product information. Fairchild and our Authorized Distributors will stand behind all warranties and will appropriately address any warranty issues that may arise. Fairchild will not provide any warranty coverage or other assistance for parts bought from Unauthorized Sources. Fairchild is committed to combat this global problem and encourage our customers to do their part in stopping this practice by buying direct or from authorized distributors.

PRODUCT STATUS DEFINITIONS

Definition of Terms

| Datasheet Identification | Product Status | Definition |
|--------------------------|-----------------------|---|
| Advance Information | Formative / In Design | Datasheet contains the design specifications for product development. Specifications may change in any manner without notice. |
| Preliminary | First Production | Datasheet contains preliminary data; supplementary data will be published at a later date. Fairchild Semiconductor reserves the right to make changes at any time without notice to improve design. |
| No Identification Needed | Full Production | Datasheet contains final specifications. Fairchild Semiconductor reserves the right to make changes at any time without notice to improve the design. |
| Obsolete | Not In Production | Datasheet contains specifications on a product that is discontinued by Fairchild Semiconductor. The datasheet is for reference information only. |

Rev. I54

ON Semiconductor and  are trademarks of Semiconductor Components Industries, LLC dba ON Semiconductor or its subsidiaries in the United States and/or other countries. ON Semiconductor owns the rights to a number of patents, trademarks, copyrights, trade secrets, and other intellectual property. A listing of ON Semiconductor's product/patent coverage may be accessed at www.onsemi.com/site/pdf/Patent-Marking.pdf. ON Semiconductor reserves the right to make changes without further notice to any products herein. ON Semiconductor makes no warranty, representation or guarantee regarding the suitability of its products for any particular purpose, nor does ON Semiconductor assume any liability arising out of the application or use of any product or circuit, and specifically disclaims any and all liability, including without limitation special, consequential or incidental damages. Buyer is responsible for its products and applications using ON Semiconductor products, including compliance with all laws, regulations and safety requirements or standards, regardless of any support or applications information provided by ON Semiconductor. "Typical" parameters which may be provided in ON Semiconductor data sheets and/or specifications can and do vary in different applications and actual performance may vary over time. All operating parameters, including "Typicals" must be validated for each customer application by customer's technical experts. ON Semiconductor does not convey any license under its patent rights nor the rights of others. ON Semiconductor products are not designed, intended, or authorized for use as a critical component in life support systems or any FDA Class 3 medical devices or medical devices with a same or similar classification in a foreign jurisdiction or any devices intended for implantation in the human body. Should Buyer purchase or use ON Semiconductor products for any such unintended or unauthorized application, Buyer shall indemnify and hold ON Semiconductor and its officers, employees, subsidiaries, affiliates, and distributors harmless against all claims, costs, damages, and expenses, and reasonable attorney fees arising out of, directly or indirectly, any claim of personal injury or death associated with such unintended or unauthorized use, even if such claim alleges that ON Semiconductor was negligent regarding the design or manufacture of the part. ON Semiconductor is an Equal Opportunity/Affirmative Action Employer. This literature is subject to all applicable copyright laws and is not for resale in any manner.

PUBLICATION ORDERING INFORMATION

LITERATURE FULFILLMENT:

Literature Distribution Center for ON Semiconductor
19521 E. 32nd Pkwy, Aurora, Colorado 80011 USA
Phone: 303-675-2175 or 800-344-3860 Toll Free USA/Canada
Fax: 303-675-2176 or 800-344-3867 Toll Free USA/Canada
Email: orderlit@onsemi.com

N. American Technical Support: 800-282-9855 Toll Free
USA/Canada
Europe, Middle East and Africa Technical Support:
Phone: 421 33 790 2910
Japan Customer Focus Center
Phone: 81-3-5817-1050

ON Semiconductor Website: www.onsemi.com
Order Literature: <http://www.onsemi.com/orderlit>
For additional information, please contact your local
Sales Representative

Mouser Electronics

Authorized Distributor

Click to View Pricing, Inventory, Delivery & Lifecycle Information:

[ON Semiconductor:](#)

[FAN7346M](#) [FAN7346MX](#)